



### Features

- Low driver power requirements (TTL/CMOS Compatible)
- No moving parts
- High reliability
- Arc-Free with no snubbing circuits
- 3750Vrms Input/Output isolation

### Applications

- Telecommunications (PC, Electronic notepad)
- Measuring and Testing equipment
- Industrial control
- Security equipments
- High speed inspection machine

### Outline Dimensions



DIP4



SMD4

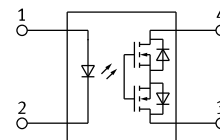

1. LED Anode
2. LED Cathode
3. Drain (MOSFET)
4. Drain (MOSFET)

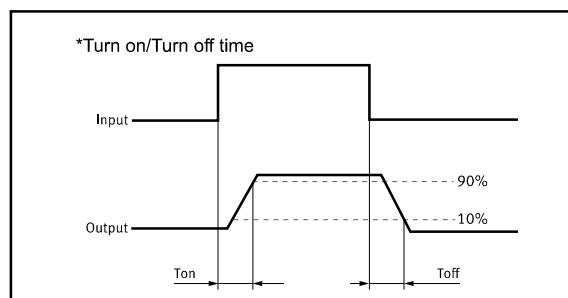

### TYPES

Category	Output rating		Package	Part No.	Packing quantity
	Load voltage	Load current			
AC/DC	400V	0.13A	DIP4	GAQY214E	50pcs/tube
			SMD4	GAQY214EH	1000pcs/reel

#### Absolute Maximum Ratings (Ambient Temperature: 25°C)

Item		Symbol	Value	Units	Note
Input	Continuous LED Current	$I_F$	50	mA	
	Peak LED Current	$I_{FP}$	1000	mA	f=100Hz, uty=1%
	LED Reverse Voltage	$V_R$	5	V	
	Input Power Dissipation	$P_{In}$	75	mW	
Output	Load Voltage	$V_L$	400	V(AC peak or DC)	
	Load Current	$I_L$	130	mA	
	Peak Load Current	$I_{Peak}$	0.6	A	100ms(1 pulse)
	Output Power Dissipation	$P_{out}$	300	mW	
Total Power Dissipation		$P_T$	350	mW	
I/O Breakdown Voltage		$V_{I/O}$	3750	Vrms	RH=60%, 1min
Operating Temperature		$T_{Opr}$	-40 to +85	°C	
Storage Temperature		$T_{Stg}$	-40 to +100	°C	
Pin Soldering Temperature		$T_{Sol}$	260	°C	10 sec max.

#### Electrical Specifications (Ambient Temperature: 25°C)

Item		Symbol	MIN.	TYP.	MAX.	Units	Conditions
Input	LED Forward Voltage	$V_F$		1.2	1.4	V	$I_F=10mA$
	Operation LED Current	$I_{F On}$		0.5	3.0	mA	
	Recovery LED Current	$I_{F Off}$		0.35	0.5	mA	
	Recovery LED Voltage	$V_{F Off}$	0.5			V	
Output	On-Resistance	$R_{On}$		16	25	$\Omega$	$I_F=5mA, I_L=120mA$ , Time to flow is within 1 sec.
	Off-State Leakage Current	$I_{Leak}$			1	$\mu A$	$V_L=Rating$
	Output Capacitance	$C_{Out}$		110		pF	$V_L=0, f=1MHz$
Transmis sion	Turn-On Time	$T_{On}$		0.5	1	ms	$I_F=5mA, I_L=100mA$
	Turn-Off Time	$T_{Of}$		0.03	0.5	ms	
Coupled	I/O Isolation Resistance	$R_{I/O}$	$10^{10}$			$\Omega$	DC500V
	I/O Capacitance	$C_{I/O}$		0.8	1.5	pF	f=1MHz

### Reference Data

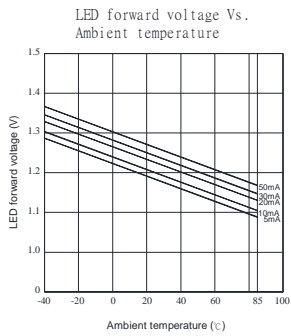
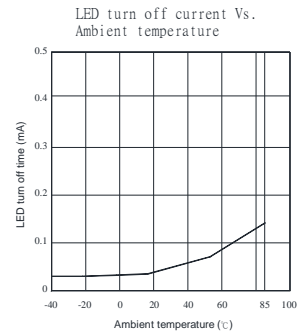
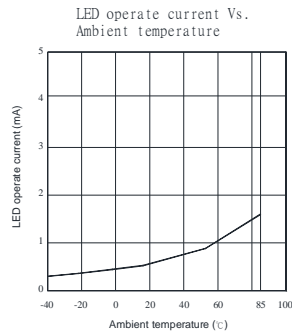
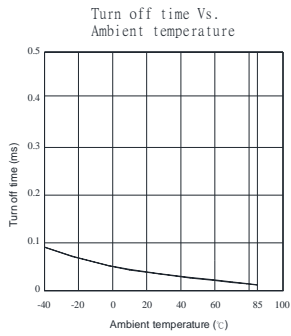
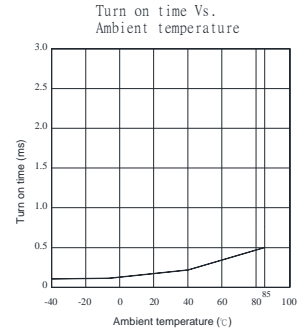
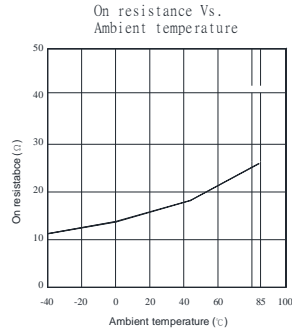
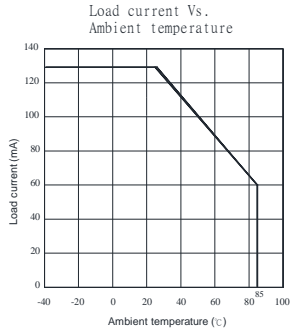

Voltage Vs. current characteristics of output at MOS portion

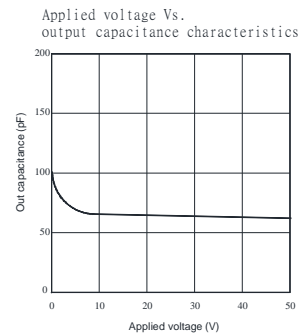
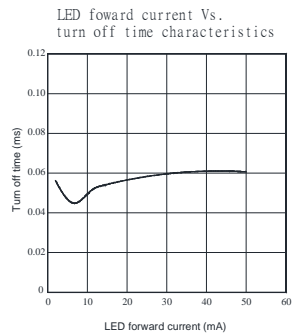
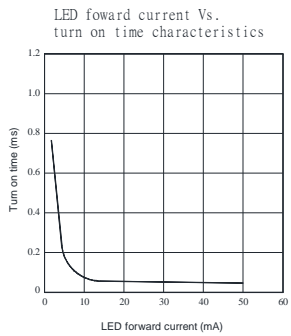
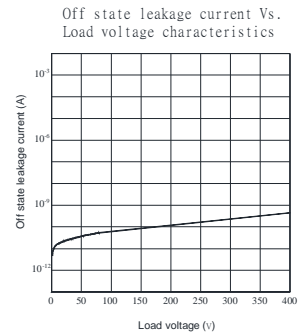
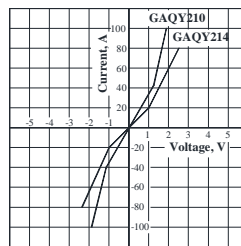

### Dimensions

#### 4-SMD



#### Dimensions

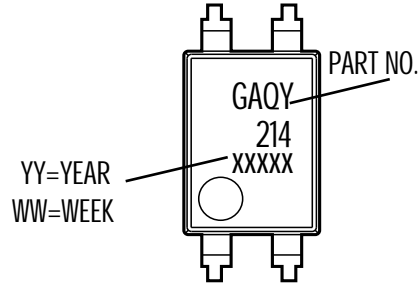

#### Surface mount terminal type

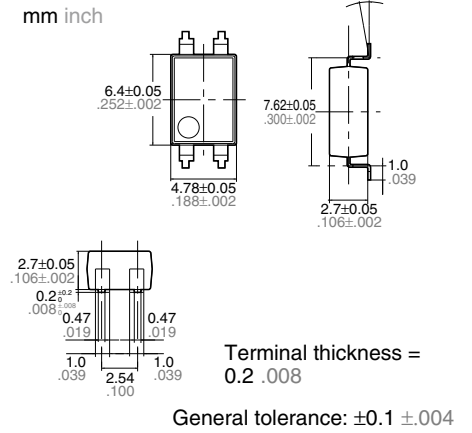

#### PC board pattern (Top view)

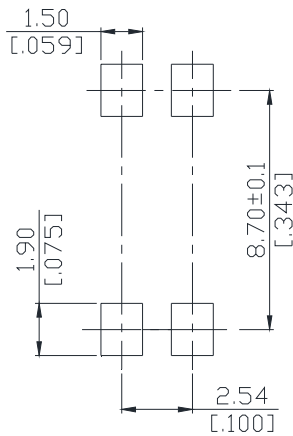

#### Tape dimensions

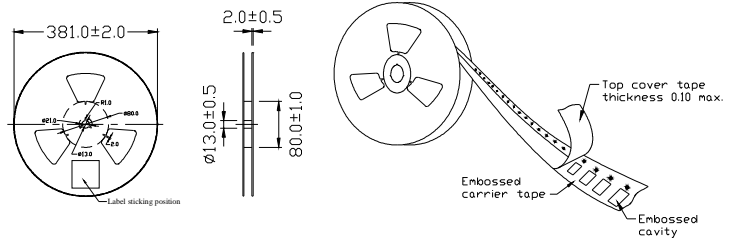

Unit : mm [inch]  
Tolerance : ±0.1

#### Dimensions of tape reel

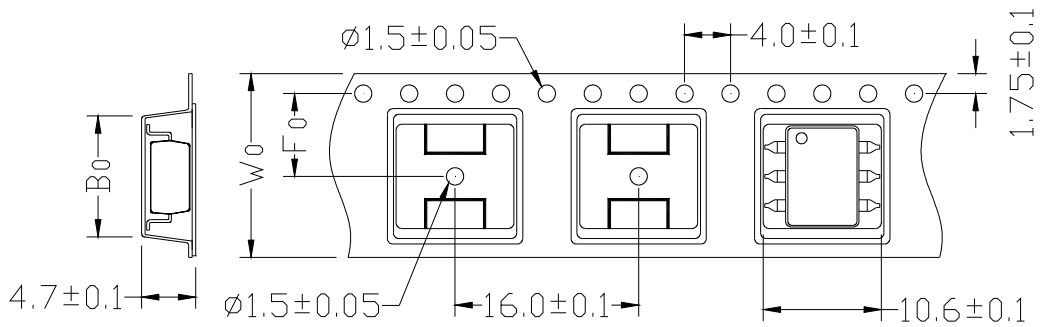

Unit: mm

TYPE	B0±0.1	F0±0.1	W0±0.1	13"REEL/PCS
4P	5.3	7.5	16	1000

## Dimensions

### 4-DIP

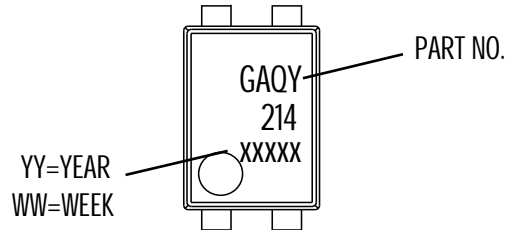

mm inch

### Dimensions

#### Through hole terminal type

#### PC board pattern

(TOP VIEW)

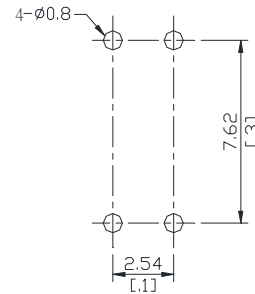
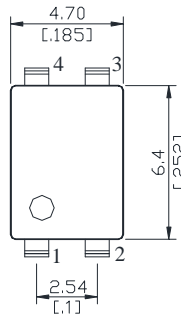
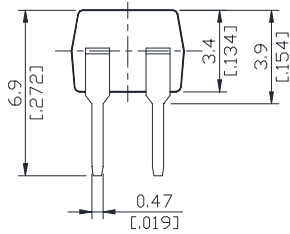
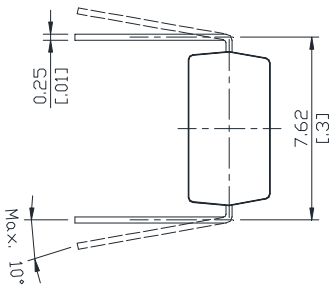

Unit : mm inch  
Tolerance: +0.2 +.007

### DIP type

Devices are packaged in a tube so that pin No. 1 is on the stopper B side. Observe correct orientation when mounting them on PC boards.

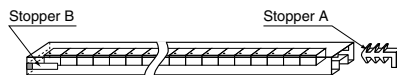

## X-ON Electronics

Largest Supplier of Electrical and Electronic Components

*Click to view similar products for [Solid State Relays - PCB Mount](#) category:*

*Click to view products by [SUPSiC](#) manufacturer:*

Other Similar products are found below :

[M86F-2W](#) [M90F-2W](#) [M90F-2Y](#) [901-SX](#) [G2-1A07-ST](#) [G2-1A07-TT](#) [G2-1B02-TT](#) [G2-DA06-ST](#) [PLA134S](#) [DS11-1005](#) [AQH3213J](#)  
[AQV112KLAXJ](#) [AQV210EHJ](#) [AQV212J](#) [AQV252GAJ](#) [AQY210ST](#) [AQY221N2SJ](#) [AQY221R2SJ](#) [EFR1200480A150](#) [901-7](#) [LCA220](#)  
[LCB110S](#) [1618400-5](#) [SR75-1ST](#) [AQV112KLJ](#) [AQV212AJ](#) [AQV212SXJ](#) [AQV238AD01](#) [AQV252GAXJ](#) [AQW414TS](#) [AQY212ST](#)  
[AQY221R2VJ](#) [AQY275AXJ](#) [AQY414SXE01](#) [G2-1A02-ST](#) [G2-1A03-ST](#) [G2-1A03-TT](#) [G2-1A05-ST](#) [G2-1A06-TT](#) [G2-1A23-TT](#) [G2-1B01-](#)  
[ST](#) [G2-1B01-TT](#) [G2-1B02-ST](#) [G2-DA03-ST](#) [G2-DA03-TT](#) [G2-DA06-TT](#) [3-1617776-2](#) [CTA2425](#) [LBA110S](#) [LBB110S](#)