



Features

- SOP package 4 Pin type in miniature design (4.4×4.3×2.1mm / .173×.169×.083inch)
- Low driver power requirements (TTL/CMOS Compatible)
- **Hi-A : Load Current = 2.5A**
- No moving parts
- High reliability
- Arc-Free with no snubbing circuits
- 1500Vrms Input/Output isolation
- Tape & Reel version available

Applications

- Telecommunications (PC, Electronic notepad)
- Measuring and Testing equipment
- Industrial control
- Security equipments
- High speed inspection machine



SOP-4

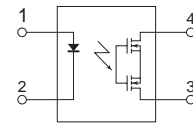

1. LED Anode
2. LED Cathode
- 3, 4. Drain (MOS FET)

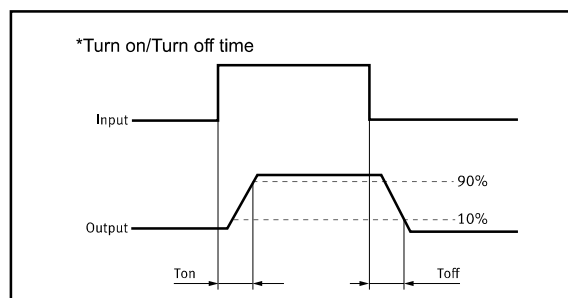

TYPES

Category	Output rating ^{*1}		Part No.	Packing quantity
	Load voltage	Load current	SOP	Tape and reel
AC/DC	60V	2.5A	GAQY252G3S	1-reel: 1,000 pcs.

Absolute Maximum Ratings (Ambient Temperature: 25°C)

Item		Symbol	Value	Units	Note
Input	Continuous LED Current	I_F	50	mA	
	Peak LED Current	I_{FP}	1000	mA	f=100Hz, duty=1%
	LED Reverse Voltage	V_R	5	V	
	Input Power Dissipation	P_{In}	75	mW	
Output	Load Voltage	V_L	60	V(AC peak or DC)	
	Load Current	I_L	2.5	A	
	Peak Load Current	I_{Peak}	5.0	A	100ms(1 pulse)
	Output Power Dissipation	P_{out}	400	mW	
Total Power Dissipation		P_T	500	mW	
I/O Breakdown Voltage		$V_{I/O}$	1500	V _{rms}	RH=60%, 1min
Operating Temperature		T_{opr}	-40 to +85	°C	
Storage Temperature		T_{stg}	-40 to +100	°C	
Pin Soldering Temperature		T_{sol}	260	°C	10 sec max.

Electrical Specifications (Ambient Temperature: 25°C)

Item		Symbol	MIN.	TYP.	MAX.	Units	Conditions
Input	LED Forward Voltage	V_F		1.2	1.4	V	$I_F=10mA$
	Operation LED Current	$I_{F on}$		0.5	3.0	mA	
	Recovery LED Current	$I_{F off}$		0.35	0.5	mA	
	Recovery LED Voltage	$V_{F off}$	0.7			V	
Output	On-Resistance	R_{on}		0.06	0.1	Ω	$I_F=5mA, I_L=100mA$, Time to flow is within 1 sec.
	Off-State Leakage Current	I_{Leak}			1	μA	$V_L=Rating$
	Output Capacitance	C_{out}		150		pF	$V_L=0, f=1MHz$
Transmission	Turn-On Time	T_{on}		1.5	3.0	ms	$I_F=5mA, I_L=100mA$,
	Turn-Off Time	T_{off}		0.1	0.3	ms	
Coupled	I/O Isolation Resistance	$R_{I/O}$	10^{10}			Ω	DC500V
	I/O Capacitance	$C_{I/O}$		0.8	1.5	pF	f=1MHz

Reference Data

Load current Vs. Ambient temperature

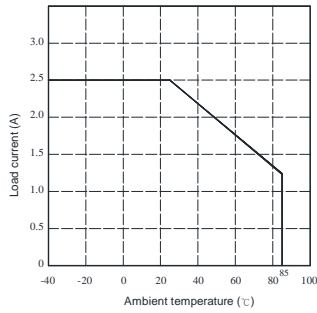

On resistance Vs. Ambient temperature

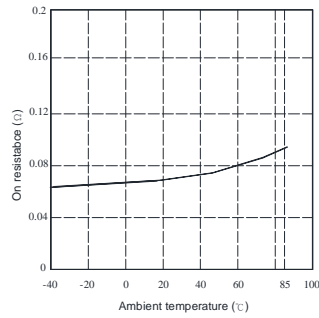

Turn on time Vs. Ambient temperature

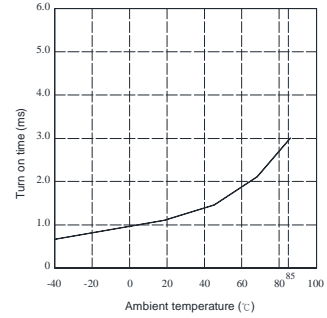

Turn off time Vs. Ambient temperature

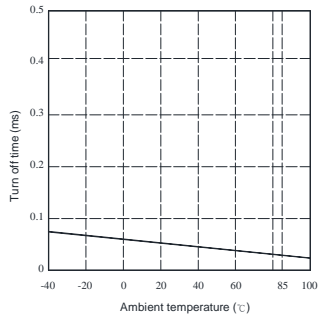

LED operate current Vs. Ambient temperature

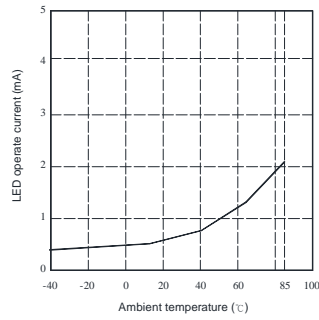

LED turn off current Vs. Ambient temperature

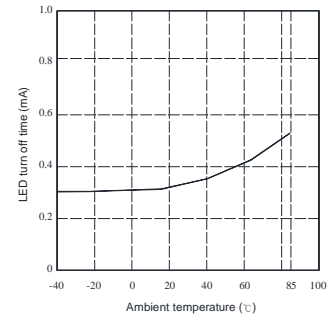

LED forward voltage Vs. Ambient temperature

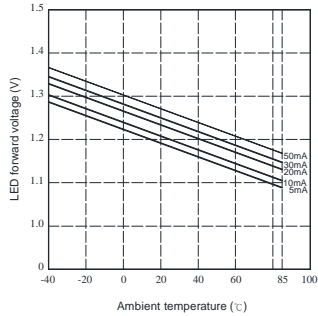

Voltage Vs. current characteristics of output at MOS portion

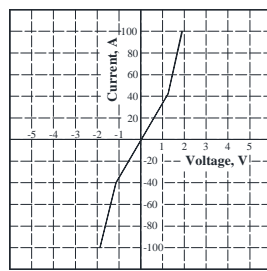

Off state leakage current Vs. Load voltage characteristics

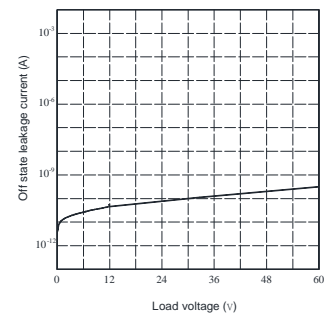

LED forward current Vs. turn on time characteristics

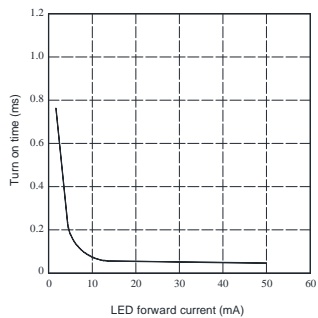

LED forward current Vs. turn off time characteristics

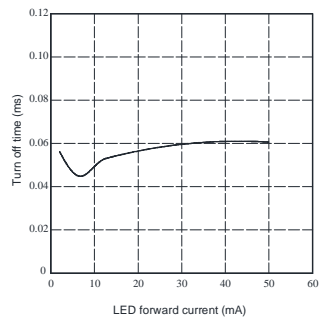

Applied voltage Vs. output capacitance characteristics

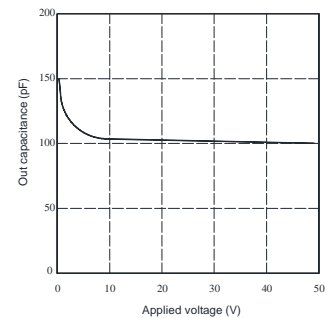

Dimensions

4-SOP

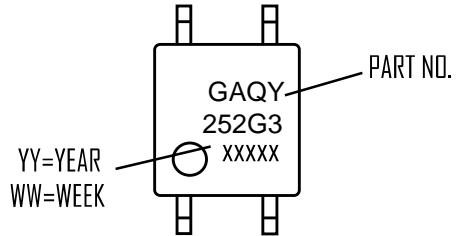

Surface mount terminal type

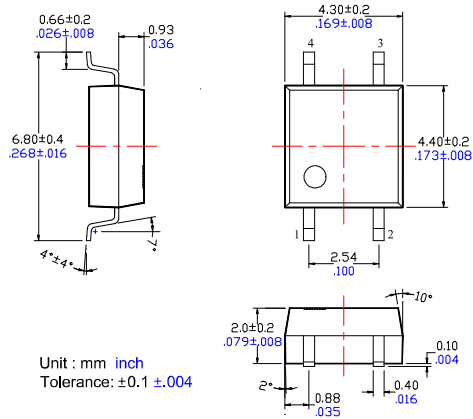

Recommended mounting pad (Top view)

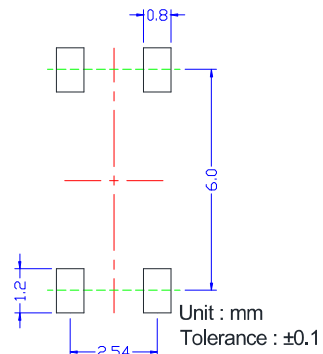

Tape dimensions

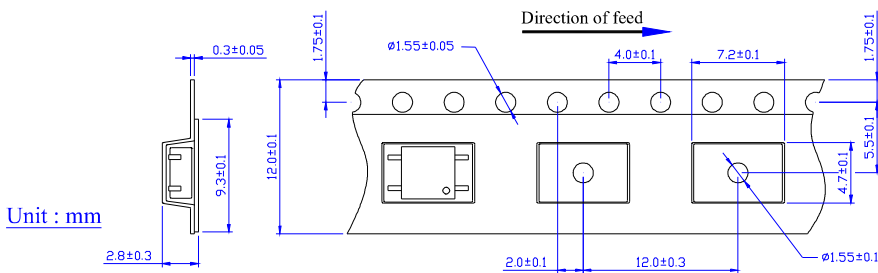

Dimensions of tape reel

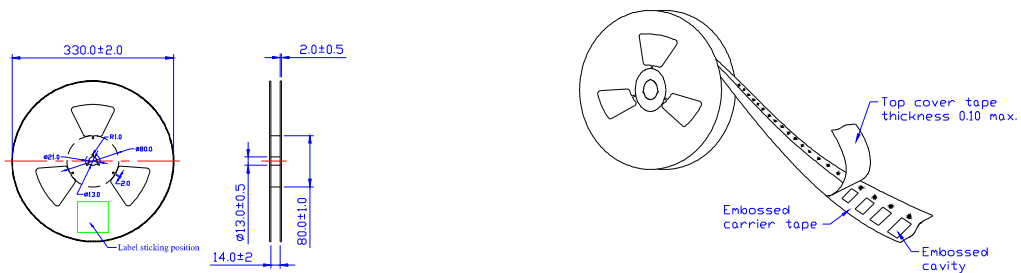

X-ON Electronics

Largest Supplier of Electrical and Electronic Components

Click to view similar products for [Solid State Relays - PCB Mount](#) category:

Click to view products by [SUPSiC](#) manufacturer:

Other Similar products are found below :

[M86F-2W](#) [M90F-2W](#) [M90F-2Y](#) [901-SX](#) [G2-1A07-ST](#) [G2-1A07-TT](#) [G2-1B02-TT](#) [G2-DA06-ST](#) [PLA134S](#) [DS11-1005](#) [AQH3213J](#)
[AQV112KLAXJ](#) [AQV210EHJ](#) [AQV212J](#) [AQV252GAJ](#) [AQY210ST](#) [AQY221N2SJ](#) [AQY221R2SJ](#) [EFR1200480A150](#) [901-7](#) [LCA220](#)
[LCB110S](#) [1618400-5](#) [SR75-1ST](#) [AQV112KLJ](#) [AQV212AJ](#) [AQV212SXJ](#) [AQV238AD01](#) [AQV252GAXJ](#) [AQW414TS](#) [AQY212ST](#)
[AQY221R2VJ](#) [AQY275AXJ](#) [AQY414SXE01](#) [G2-1A02-ST](#) [G2-1A03-ST](#) [G2-1A03-TT](#) [G2-1A05-ST](#) [G2-1A06-TT](#) [G2-1A23-TT](#) [G2-1B01-](#)
[ST](#) [G2-1B01-TT](#) [G2-1B02-ST](#) [G2-DA03-ST](#) [G2-DA03-TT](#) [G2-DA06-TT](#) [3-1617776-2](#) [CTA2425](#) [LBA110S](#) [LBB110S](#)