



Features

- SOP package 4 Pin type in miniature design (4.4×4.3×2.1mm / .173×.169×.083inch)
- Low driver power requirements (TTL/CMOS Compatible)
- Contact form: Normally-OFF (1b)
- Load voltage: 60V max.
- On-Resistance: 1.5Ω max.
- 1500Vrms Input/Output isolation
- Tape & Reel version available

Applications

- Telecommunications (PC, Electronic notepad)
- Measuring and Testing equipment
- Industrial control
- Security equipments
- High speed inspection machine



SOP-4

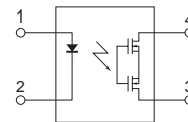

1. LED Anode
2. LED Cathode
3. Drain (MOSFET)
4. Drain (MOSFET)

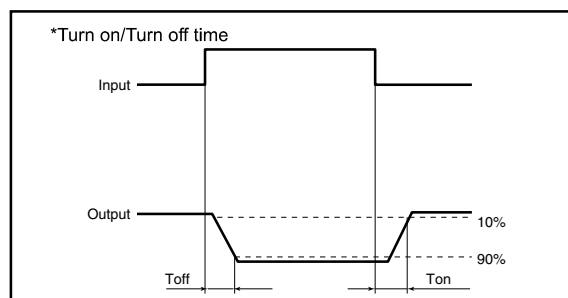

TYPES

Category	Output rating ^{*1}		Part No.	Packing quantity
	Load voltage	Load current	SOP-4	Tape and reel
AC/DC	60V	500mA	GAQY412S	2000pcs/1reel

Absolute Maximum Ratings (Ambient Temperature: 25°C)

Item		Symbol	Value	Units	Note
Input	Continuous LED Current	I _F	50	mA	
	Peak LED Current	I _{FP}	500	mA	f=100Hz, duty=1%
	LED Reverse Voltage	V _R	5	V	
	Input Power Dissipation	P _{In}	75	mW	
Output	Load Voltage	V _L	60	V(AC peak or DC)	
	Load Current	I _L	500	mA	
	Peak Load Current	I _{Peak}	0.6	A	1ms(1 pulse)
	Output Power Dissipation	P _{Out}	300	mW	
Total Power Dissipation		P _T	350	mW	
I/O Breakdown Voltage		V _{I/O}	1500	V _{rms}	RH=60%, 1min
Operating Temperature		T _{opr}	-40 to +85	°C	
Storage Temperature		T _{stg}	-40 to +100	°C	
Pin Soldering Temperature		T _{sol}	260	°C	10 sec max.

Electrical Specifications (Ambient Temperature: 25°C)

Item		Symbol	MIN.	TYP.	MAX.	Units	Conditions
Input	LED Forward Voltage	V _F		1.2	1.4	V	I _F =10mA
	Operation LED Current	I _{Fon}		0.5	3.0	mA	
	Recovery LED Current	I _{Foff}	0.1	0.4		mA	
	Recovery LED Voltage	V _{Foff}	0.5			V	
Output	On-Resistance	R _{on}		0.8	1.5	Ω	I _F =0mA, I _L =100mA, Time to flow is within 1 sec.
	Off-State Leakage Current	I _{Leak}			1	uA	I _F =5mA, V _L =60V
	Output Capacitance	C _{out}		165		pF	I _F =5mA, V _L =0V, f=1MHz
Transmission	Turn-Off Time	T _{off}		0.5	1.0	ms	I _F =5mA, I _L =100mA
	Turn-On Time	T _{on}		0.25	2.0	ms	
Coupled	I/O Isolation Resistance	R _{I/O}	10 ¹⁰			Ω	DC500V
	I/O Capacitance	C _{I/O}		0.8		pF	f=1MHz

Reference Data

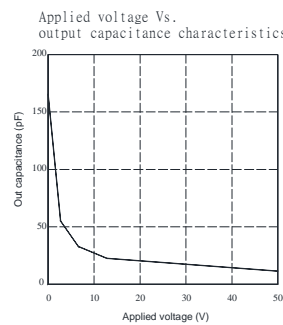
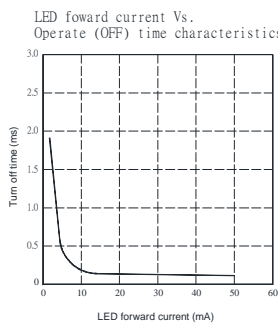
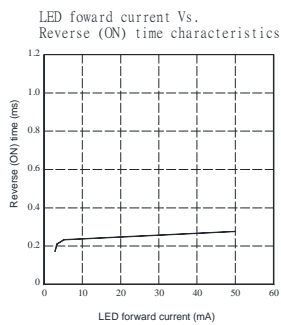
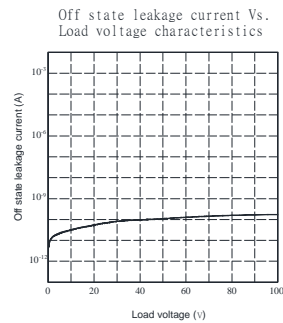
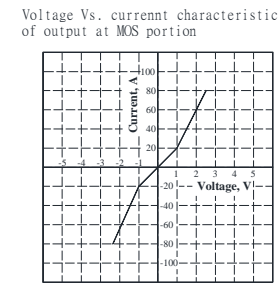
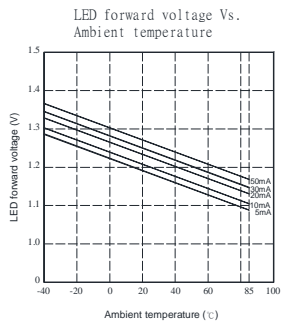
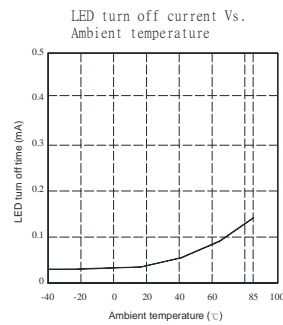
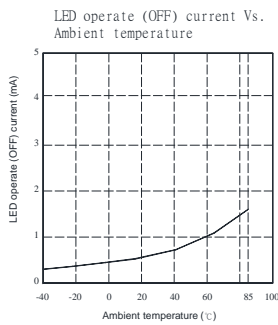
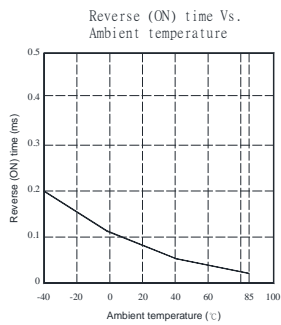
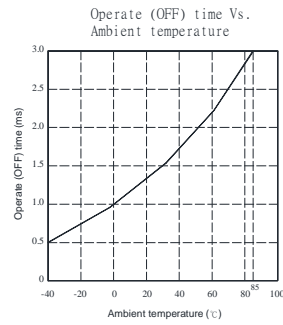
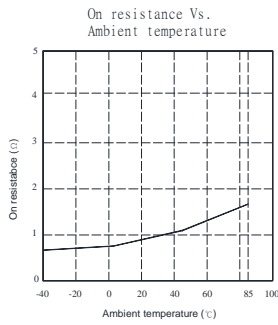
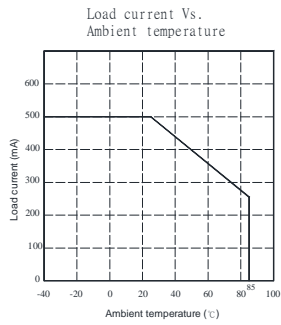

Dimensions

4-SOP

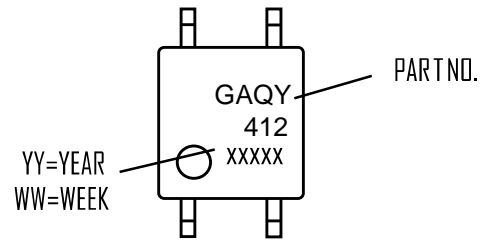

Surface mount terminal type

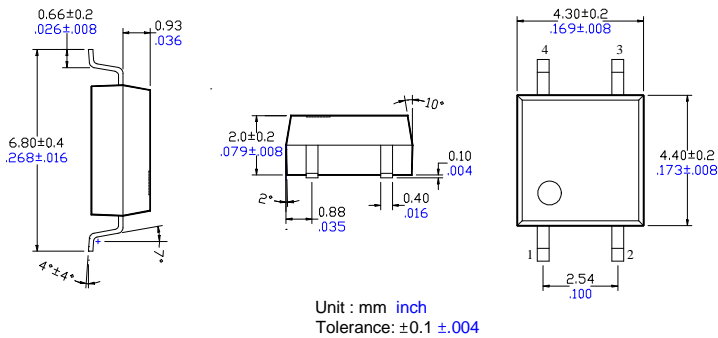

Recommended mounting pad (Top view)

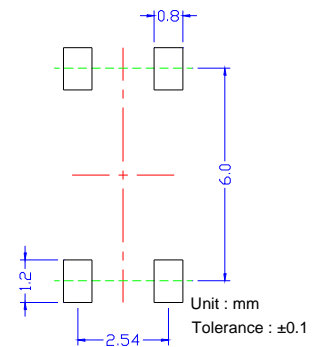

Tape dimensions

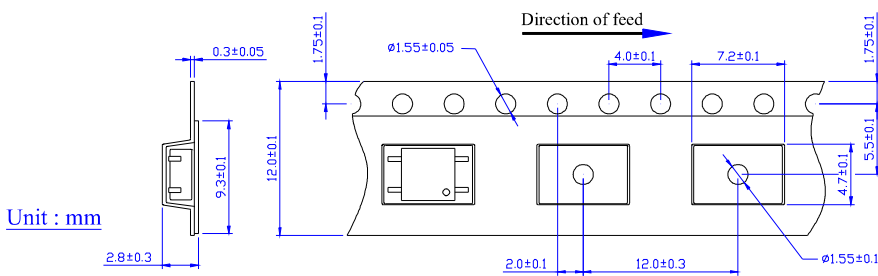

Dimensions of tape reel

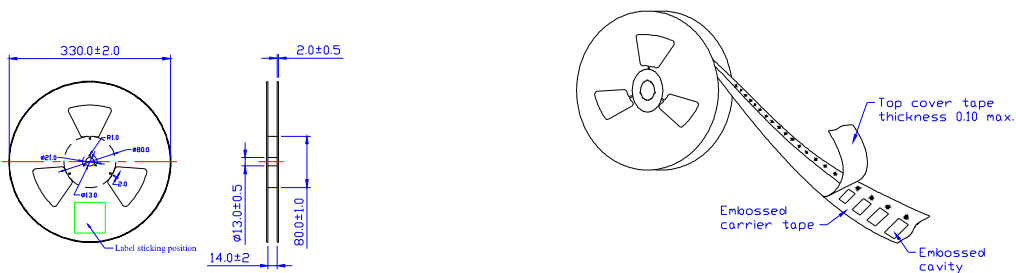

X-ON Electronics

Largest Supplier of Electrical and Electronic Components

Click to view similar products for [Solid State Relays - PCB Mount](#) category:

Click to view products by [SUPSiC](#) manufacturer:

Other Similar products are found below :

[M86F-2W](#) [M90F-2W](#) [M90F-2Y](#) [901-SX](#) [G2-1A07-ST](#) [G2-1A07-TT](#) [G2-1B02-TT](#) [G2-DA06-ST](#) [PLA134S](#) [DS11-1005](#) [AQH3213J](#)
[AQV112KLAXJ](#) [AQV210EHJ](#) [AQV212J](#) [AQV252GAJ](#) [AQY210ST](#) [AQY221N2SJ](#) [AQY221R2SJ](#) [EFR1200480A150](#) [901-7](#) [LCA220](#)
[LCB110S](#) [1618400-5](#) [SR75-1ST](#) [AQV112KLJ](#) [AQV212AJ](#) [AQV212SXJ](#) [AQV238AD01](#) [AQV252GAXJ](#) [AQW414TS](#) [AQY212ST](#)
[AQY221R2VJ](#) [AQY275AXJ](#) [AQY414SXE01](#) [G2-1A02-ST](#) [G2-1A03-ST](#) [G2-1A03-TT](#) [G2-1A05-ST](#) [G2-1A06-TT](#) [G2-1A23-TT](#) [G2-1B01-](#)
[ST](#) [G2-1B01-TT](#) [G2-1B02-ST](#) [G2-DA03-ST](#) [G2-DA03-TT](#) [G2-DA06-TT](#) [3-1617776-2](#) [CTA2425](#) [LBA110S](#) [LBB110S](#)