

Features

- 1.2kV Schottky Rectifier
- Zero Reverse Recovery Current
- High-Frequency Operation
- Temperature-Independent Switching
- Extremely Fast Switching
- Positive Temperature Coefficient on V_F

Benefits

- Replace Bipolar with Unipolar Rectifiers
- Essentially No Switching Losses
- Higher Efficiency
- Reduction of Heat Sink Requirements
- Parallel Devices Without Thermal Runaway

Applications

- Switch Mode Power Supplies (SMPS)
- Boost diodes in PFC or DC/DC stages
- Free Wheeling Diodes in Inverter stages
- AC/DC converters

Part Number	Package	Marking
GC4D12120A	TO-220-2	GC4D12120A

V_{RRM}	=	1200V
$I_F(T_c=135^\circ\text{C})$	=	16A
Q_c	=	52 nC

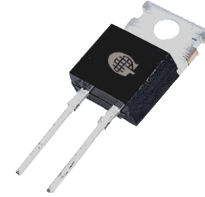

TO-220-2



Maximum Ratings ($T_c=25^\circ\text{C}$ unless otherwise specified)

Symbol	Parameter	Value	Unit	Test Conditions	Note
V_{RRM}	Repetitive Peak Reverse Voltage	1200	V		
V_{RSM}	Surge Peak Reverse Voltage	1300	V		
V_R	DC Peak Reverse Voltage	1200	V		
I_F	Continuous Forward Current	33 16 12	A	$T_c=25^\circ\text{C}$ $T_c=135^\circ\text{C}$ $T_c=156^\circ\text{C}$	Fig. 3
I_{FRM}	Repetitive Peak Forward Surge Current	47 31.5	A	$T_c=25^\circ\text{C}$, $t_p=10$ ms, Half Sine Pulse $T_c=110^\circ\text{C}$, $t_p=10$ ms, Half Sine Pulse	
I_{FSM}	Non-Repetitive Forward Surge Current	71 59.5	A	$T_c=25^\circ\text{C}$, $t_p=10$ ms, Half Sine Pulse $T_c=110^\circ\text{C}$, $t_p=10$ ms, Half Sine Pulse	Fig. 8
$I_{F,Max}$	Non-Repetitive Peak Forward Current	750 620	A	$T_c=25^\circ\text{C}$, $t_p=10$ μs , Pulse $T_c=110^\circ\text{C}$, $t_p=10$ μs , Pulse	Fig. 8
P_{tot}	Power Dissipation	166.5 72	W	$T_c=25^\circ\text{C}$ $T_c=110^\circ\text{C}$	Fig. 4
dV/dt	Diode dV/dt ruggedness	200	V/ns	$V_R=0-960\text{V}$	
$\int i^2 dt$	i^2t value	25 17.5	A^2s	$T_c=25^\circ\text{C}$, $t_p=10$ ms $T_c=110^\circ\text{C}$, $t_p=10$ ms	
T_j	Operating Junction Range	-55 to +175	$^\circ\text{C}$		
T_{stg}	Storage Temperature Range	-55 to +135	$^\circ\text{C}$		
	TO-220 Mounting Torque	1 8.8	Nm lbf-in	M3 Screw 6-32 Screw	

Electrical Characteristics

Symbol	Parameter	Typ.	Max.	Unit	Test Conditions	Note
V_F	Forward Voltage	1.35 2.2	1.8 3	V	$I_F = 10\text{ A}$ $T_J = 25^\circ\text{C}$ $I_F = 10\text{ A}$ $T_J = 175^\circ\text{C}$	Fig. 1
I_R	Reverse Current	30 55	250 350	μA	$V_R = 1200\text{ V}$ $T_J = 25^\circ\text{C}$ $V_R = 1200\text{ V}$ $T_J = 175^\circ\text{C}$	Fig. 2
Q_C	Total Capacitive Charge	52		nC	$V_R = 800\text{ V}$, $I_F = 10\text{ A}$ $di/dt = 200\text{ A}/\mu\text{s}$ $T_J = 25^\circ\text{C}$	Fig. 5
C	Total Capacitance	754 45 38		pF	$V_R = 0\text{ V}$, $T_J = 25^\circ\text{C}$, $f = 1\text{ MHz}$ $V_R = 400\text{ V}$, $T_J = 25^\circ\text{C}$, $f = 1\text{ MHz}$ $V_R = 800\text{ V}$, $T_J = 25^\circ\text{C}$, $f = 1\text{ MHz}$	Fig. 6
E_C	Capacitance Stored Energy	14.5		μJ	$V_R = 800\text{ V}$	Fig. 7

Note: This is a majority carrier diode, so there is no reverse recovery charge.

Thermal Characteristics

Symbol	Parameter	Typ.	Unit	Note
$R_{\theta JC}$	Thermal Resistance from Junction to Case	0.9	$^\circ\text{C}/\text{W}$	Fig. 9

Typical Performance

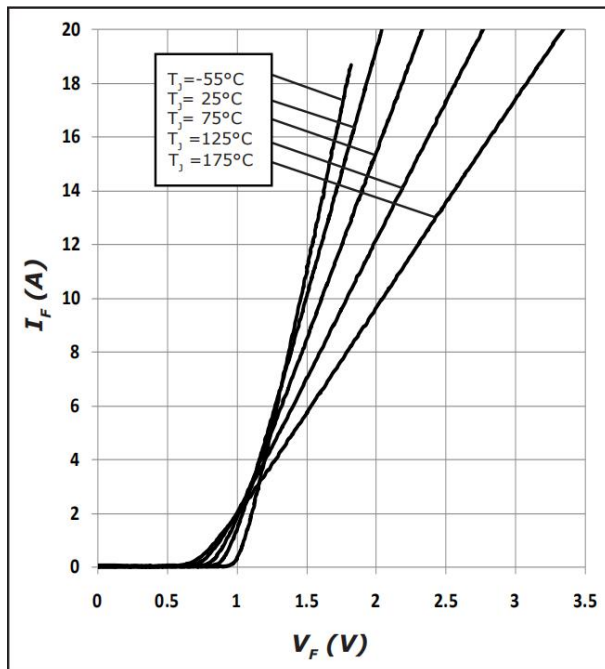

Figure 1. Forward Characteristics

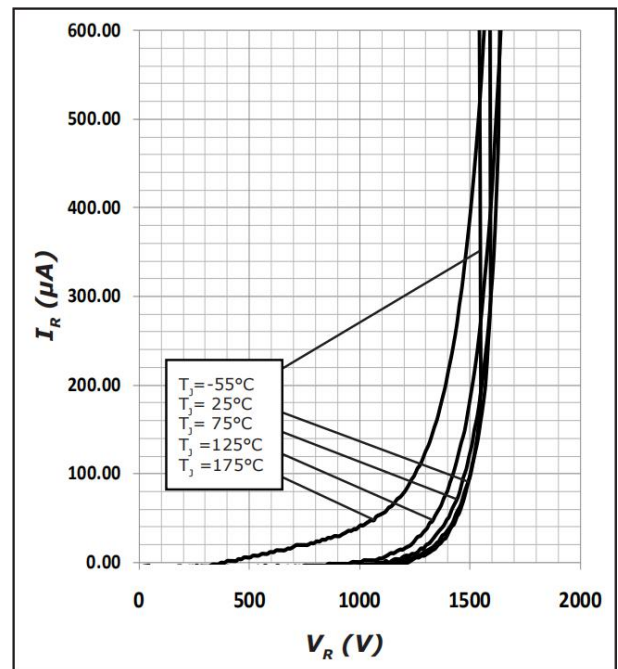

Figure 2. Reverse Characteristics

Typical Performance

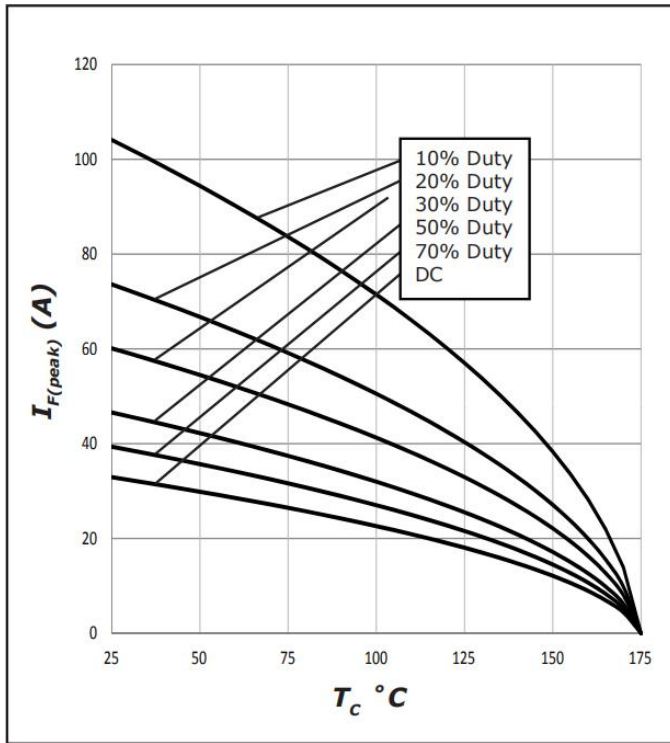

Figure 3. Current Derating

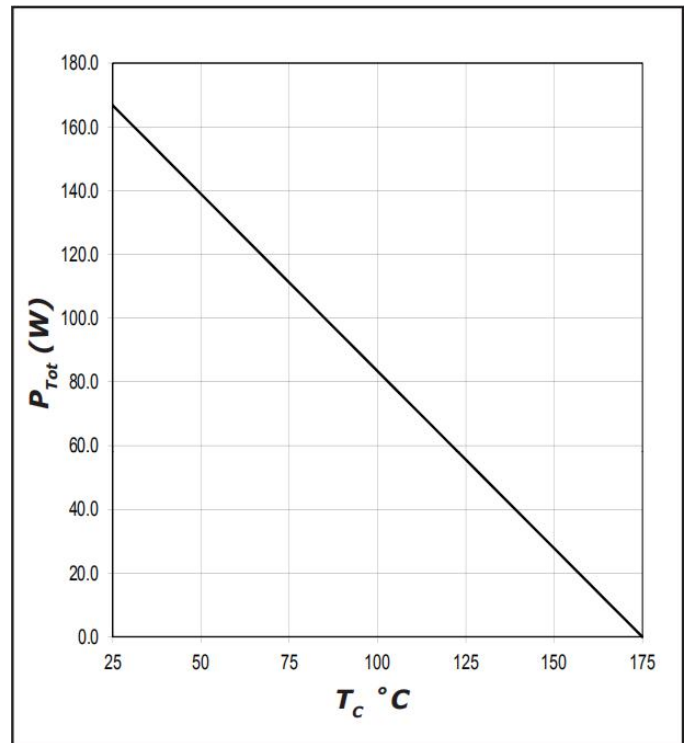

Figure 4. Power Derating

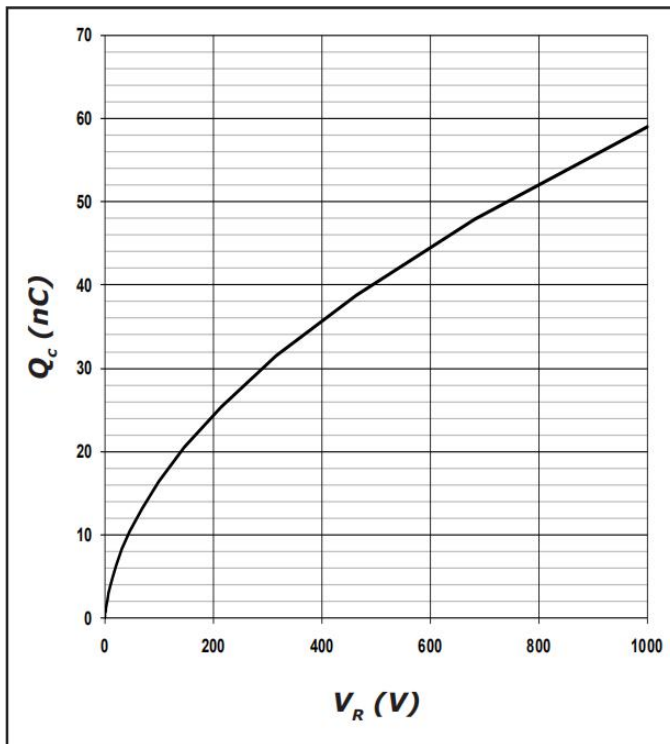

Figure 5. Recovery Charge vs. Reverse Voltage

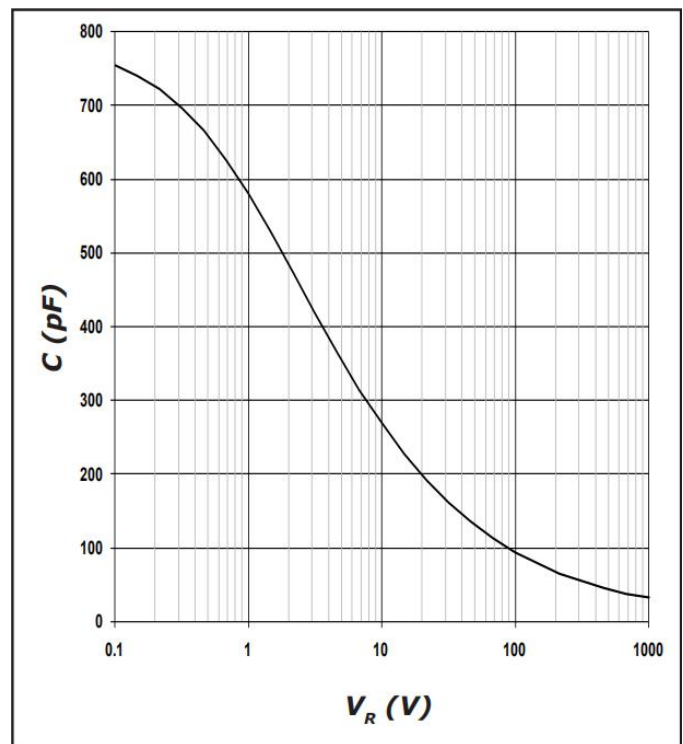

Figure 6. Capacitance vs. Reverse Voltage

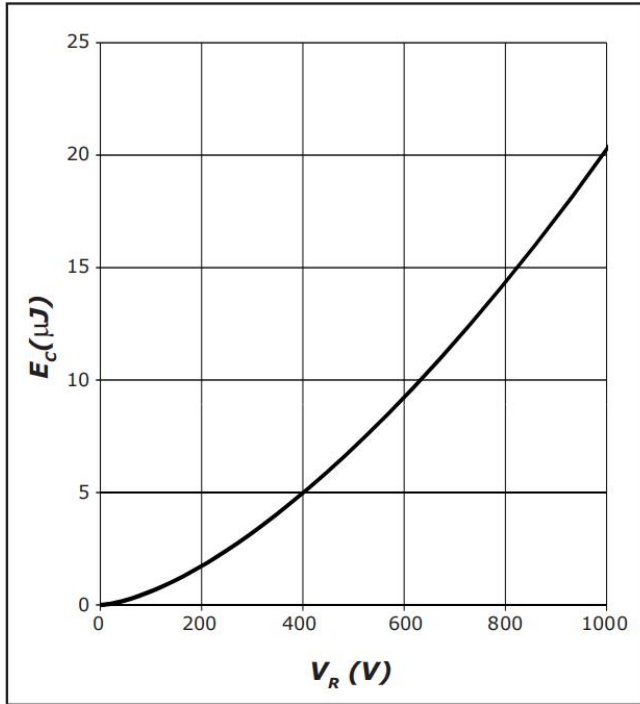

Figure 7. Typical Capacitance Stored Energy

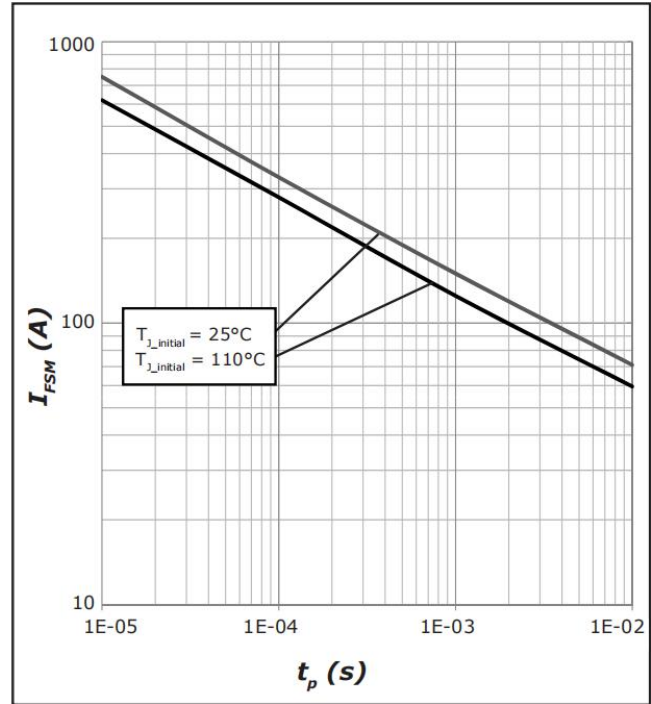

Figure 8. Non-repetitive peak forward surge current versus pulse duration (sinusoidal waveform)

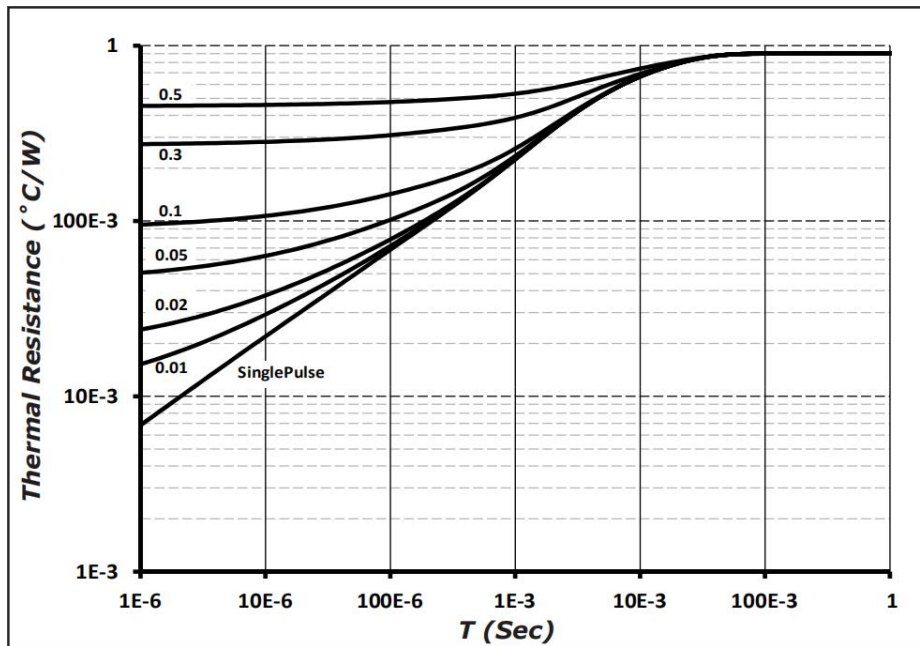
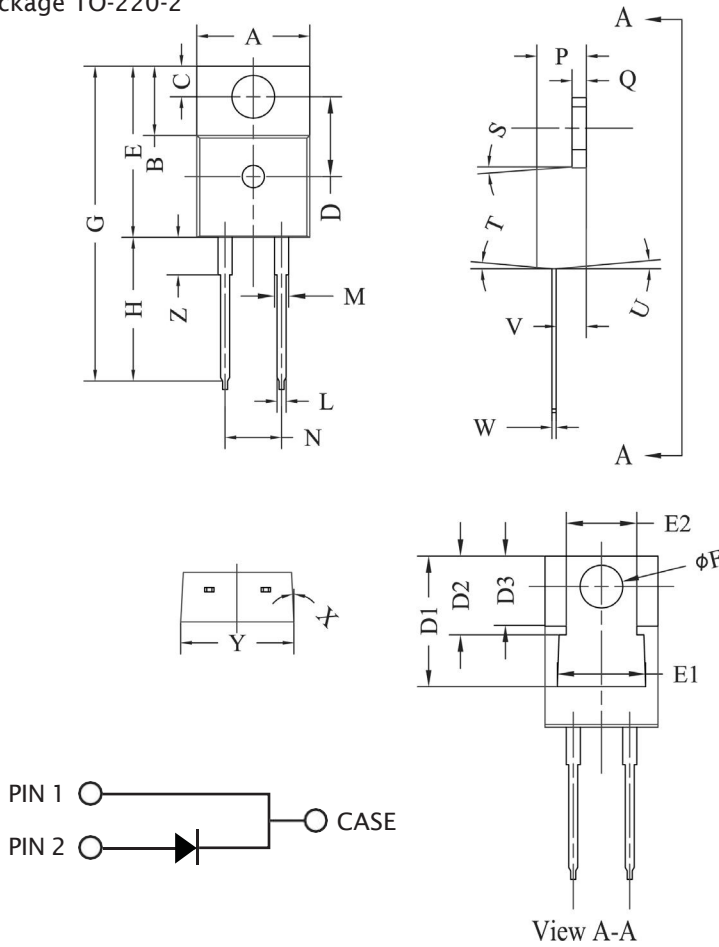

Figure 9. Transient Thermal Impedance

Package Dimensions

Package TO-220-2



POS	Inches		Millimeters	
	Min	Max	Min	Max
A	.381	.410	9.677	10.414
B	.235	.255	5.969	6.477
C	.100	.120	2.540	3.048
D	.223	.337	5.664	8.560
D1	.457-.490		11.60-12.45 typ	
D2	.277-.303 typ		7.04-7.70 typ	
D3	.244-.252 typ		6.22-6.4 typ	
E	.590	.615	14.986	15.621
E1	.302	.326	7.68	8.28
E2	.227	.251	5.77	6.37
F	.143	.153	3.632	3.886
G	1.105	1.147	28.067	29.134
H	.500	.550	12.700	13.970
L	.025	.036	.635	.914
M	.045	.055	1.143	1.550
N	.195	.205	4.953	5.207
P	.165	.185	4.191	4.699
Q	.048	.054	1.219	1.372
S	3"	6"	3"	6"
T	3"	6"	3"	6"
U	3"	6"	3"	6"
V	.094	.110	2.388	2.794
W	.014	.025	.356	.635
X	3"	5.5"	3"	5.5"
Y	.385	.410	9.779	10.414
Z	.130	.150	3.302	3.810

NOTE:

1. Dimension L, M, W apply for Solder Dip Finish

Recommended Solder Pad Layout

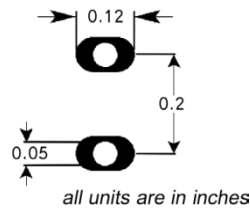

TO-220-2

Part Number	Package	Marking
GC4D12120A	TO-220-2	GC4D12120A

Diode Model

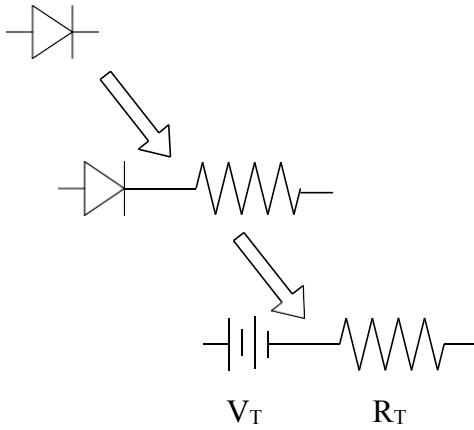

$$V_{fT} = V_T + I_f * R_T$$

$$V_T = 0.98 + (T_j * -1.71 * 10^{-3})$$

$$R_T = 0.040 + (T_j * 5.32 * 10^{-4})$$

Note: T_j = Diode Junction Temperature In Degrees Celsius,
valid from 25°C to 175°C

X-ON Electronics

Largest Supplier of Electrical and Electronic Components

Click to view similar products for [Schottky Diodes & Rectifiers](#) category:

Click to view products by [SUPSiC](#) manufacturer:

Other Similar products are found below :

[MA4E2039](#) [MMBD301M3T5G](#) [HFA35HB60C](#) [RB160M-50TR](#) [D83C](#) [BAS16E6433HTMA1](#) [BAS 3010S-02LRH](#) [E6327](#) [BAT 54-02LRH](#)
[E6327](#) [NRVBAF360T3G](#) [NSR05F40QNXT5G](#) [NTE555](#) [JANS1N6640](#) [SS3003CH-TL-E](#) [GA01SHT18](#) [CRS10I30A\(TE85L,QM](#)
[MBRA140TRPBF](#) [MBRB30H30CT-1G](#) [BAT 15-04R](#) [E6152](#) [JANTX1N5712-1](#) [DMJ3940-000](#) [SB007-03C-TB-E](#) [NRVBB20100CTT4G](#)
[NRVBM120LT1G](#) [NTSB30U100CT-1G](#) [CRG04\(T5L,TEMQ\)](#) [ACDBA1100LR-HF](#) [ACDBA1200-HF](#) [ACDBA240-HF](#) [ACDBA3100-HF](#)
[CDBQC0530L-HF](#) [ACDBA260LR-HF](#) [ACDBA1100-HF](#) [10BQ015-M3/5BT](#) [NRVBM120ET1G](#) [VSSB410S-M3/5BT](#) [1N5819T-G](#)
[PDS1040Q-13](#) [B160BQ-13-F](#) [SDM05U20CSP-7](#) [BAS 70-07](#) [E6433](#) [B140S1F-7](#) [HSM560Je3/TR13](#) [DDB2265-000](#) [ZHCS506QTA](#)
[HSM190Je3/TR13](#) [B330AF-13](#) [ACDBUC0230-HF](#) [SDM1U100S1F-7](#) [MBR10200CTF-G1](#) [CDLL5712](#)