

SURGiNG

紹 鑫 實 業



SurgeArresters

陶瓷气体放电管

SE5 Series

Features

- Surface Mounting Design 6.2×3.2×2.3mm
- High Current Handling Capability 1,000A @ 8/20 μs
- High Voltage Handling Capability 6,000V @ 10/700 μs
- Low Capacitance and Insertion Loss
- Quick Response and Long Service Life
- Moisture sensitivity level: Level 1

Application information

- xDSL
- G · FAST

Agency Approvals

Icon	Description
RoHS	Compliance with 2011/65/EU
HF	Compliance with IEC61249-2-21:2003
	Mean lead free
	Compliance with UL497B, Certificated E232249

Electrical Parameter

DC Breakdown Voltage ¹⁾²⁾⁴⁾	100V/s	360-540	V
Impulse Spark-over Voltage ⁴⁾	At 1kV/μs	for 99 % of measured values	≤ 850 V
	At 1kV/μs	Typical values of distribution	≤ 800 V
Impulse Discharge Current ³⁾⁵⁾	8/20μs 10 operations [5x (+) & 5x (-)]	1,000	A
Impulse Discharge Voltage ³⁾⁴⁾	10/700μs 20 operations [10x (+) & 10x (-)]	4,000	V
AC Discharge Current	50Hz, 1.2s, 10times	1.08A [650V, 600 Ω]	A
Arc Voltage ⁴⁾	At 1A	~8	V
Insulation Resistance ⁴⁾	DC=100V	≥1	GΩ
Capacitance at 1MHz ⁴⁾	V _{DC} =0.5V	≤1.5	pF
Weight		~0.2	g
Operating and Storage Temperature		-40-90	°C
Marking		Without	

1) At delivery AQL 0.65 level II GB/T 2828.1-2003

2) In ionized mode

3) Terms and waveforms in accordance with ITU-T Rec. K. 12 and IEC 61643-21

4) Tip electrode "1" or "3" to center electrode "2"

5) Total Currents through center electrode 2. half value through each Tip electrode "1" 、 "3" .

Exterior

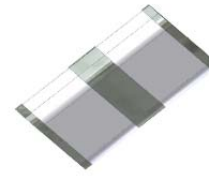

SMD

Package (Top View)

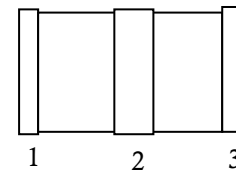

Schematic Symbol

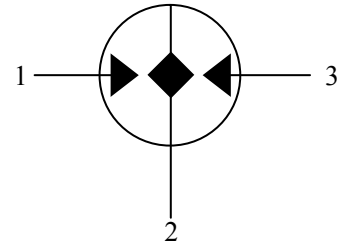

Part Numbering System

SE50 470X

(1) (2)

(1) SURGiNG 3-Electrode SMD Gas Discharge Tube

(2) DC Breakdown Voltage, e.g., 470X= 470V

Product Characteristics

Lead Material	Copper
Body Material	Ceramics
Terminal Finish	100% Matte-Tin Plated

Environmental Reliability Characteristics

Testing items	Technical standards
High Temperature Storage Test	Temperature: 85°C Time: 2H
Low Temperature Storage Test	Temperature: -40°C Time: 2H
Vibration	Frequency: 10-500Hz Amplitude: 0.15mm Time: 45min
Resistance of soldering heat	Temperature: 260±5°C Time of dip soldering: 10s, 1time

Note: Up-screen program can be specified by customer's request via contacting SURGiNG service

Solderability Test

Solderability	Solder Pot Temperature:	245°C ± 5°C
	Solder Dwell Time:	4-6 seconds

Product Dimensions

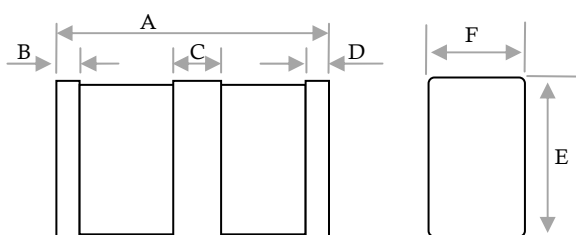

REF	mm	inch
A	6.2±0.3	0.244±0.019
B	0.3±0.1	0.019±0.004
C	1.2±0.1	0.047±0.004
D	0.3±0.1	0.019±0.004
E	3.2±0.2	0.126±0.008
F	2.3±0.2	0.091±0.008

Recommended Soldering Pad

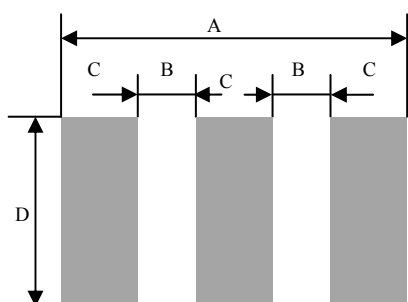

REF	mm	inch
A	7.2	0.283
B	1.5	0.059
C	1.4	0.055
D	4.0	0.157

Reflow Profile

Reflow Condition		Pb-Free assembly
Pre Heat	Temperature Min	150°C
	Temperature Max	200°C
	Time (min to max)	60 – 180 secs
Average ramp up rate (Liquids) T _{amp} (T _L) to peak		3°C/second max
T _S (max) to T _L - Ramp-up Rate		3°C/second max
Reflow	- Temperature (T _L) (Liquids)	217°C
	- Temperature (T _L)	60 – 150 seconds
Peak Temperature (T _P)		260±0/-5 °C
Time within 5°C of actual peak Temperature (t _p)		~10 seconds
Ramp-down Rate		6°C/second max
Time 25°C to peak Temperature (T _P)		8 minutes Max.
Do not exceed		260°C

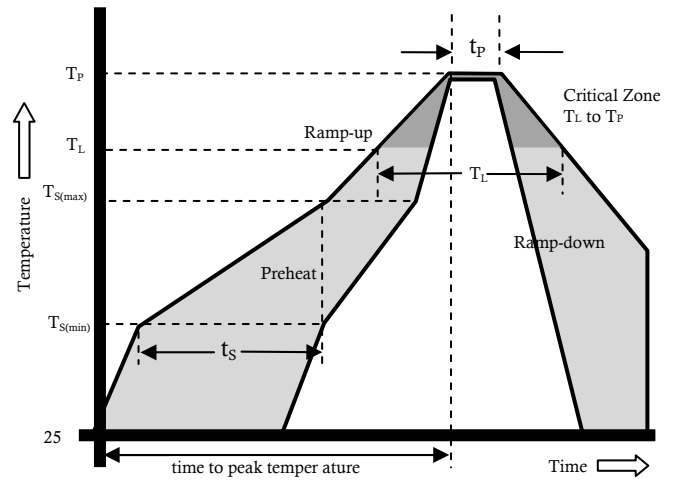

Package Reel Information

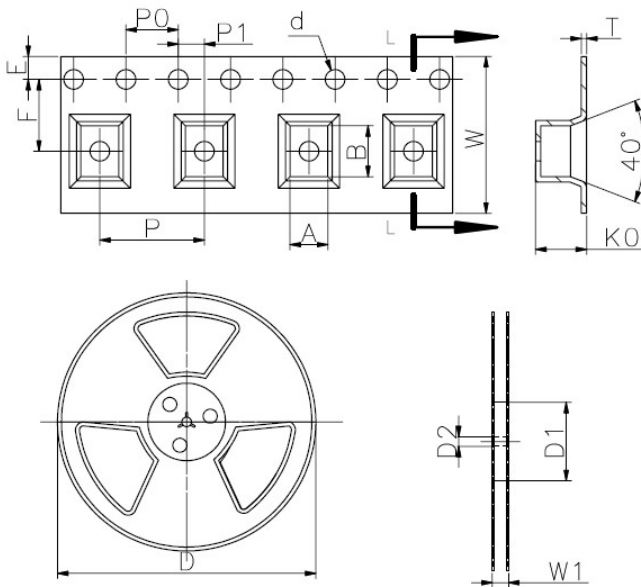

REF	mm	inch
A	3.5±0.3	0.138±0.012
B	6.6±0.3	0.260±0.012
d	Φ1.5±0.1	Φ0.059±0.004
E	1.75±0.1	0.069±0.004
F	7.5±0.1	0.295±0.004
P	8.0±0.2	0.315±0.008
P0	4.0±0.2	0.157±0.008
P1	2.0±0.1	0.079±0.004
W	16.0±0.3	0.630±0.012
T	0.3±0.05	0.012±0.002
K0	2.7±0.1	0.094±0.004
D	Φ330.0	Φ13.0
D1	Φ50Min	Φ1.97Min
D2	Φ13±0.15	Φ0.512±0.006
W1	16.8±2.0	0.661±0.079

Outline	Reel (PCS)	Per Carton (PCS)	Reel Diameter (mm)	Carton Size(mm)		
				L	W	H
TAPING	2,000	32,000	330	360	360	380

X-ON Electronics

Largest Supplier of Electrical and Electronic Components

Click to view similar products for [Gas Discharge Tubes - GDTs / Gas Plasma Arrestors](#) *category:*

Click to view products by [SURGING](#) *manufacturer:*

Other Similar products are found below :

[PMT1023004](#) [PMT1025001](#) [PMT1035004](#) [PMT1040004](#) [PMT809006](#) [CG2250](#) [CG2800](#) [CG31.5L](#) [GT-SMD181240012-TR](#) [WPGT-2N145B6L](#) [WPGT-2N230B6L](#) [WPGT-2N470B6L](#) [WPGT-2R470B6L](#) [WPGT-2RM230A6L](#) [WPGT-2RM350A6L](#) [WPGT-2RM70A6L](#) [WPGT-2RM90A6L](#) [WPGT-2S145](#) [WPGT-2S350](#) [WPGT-2S470](#) [WPGT-3R350CF](#) [WPGT-3R350G1](#) [WPGT-3R90G1](#) [WPGT-3R75G1](#) [WPGT-3R470G1](#) [WPGT-3R250C](#) [WPGT-3R230G1](#) [WPGT-2S230](#) [WPGT-2RM470A6L](#) [WPGT-2RM145A6L](#) [WPGT-2R3000B8L](#) [WPGT-2R2700B8L](#) [WPGT-2R1000B8L](#) [WPGT-2N90B6L](#) [WPGT-2N70B6L](#) [WPGT-2N350B6L](#) [WPGT-2N230B6L1](#) [CG90](#) [CG2230](#) [CG2145](#) [CG21000](#) [GT-SMD181215012-TR](#) [T61-C350X](#) [9071.99.0547 \(73_Z-0-0-547\)](#) [9071.99.0548 \(73_Z-0-0-548\)](#) [B88069X6940B152](#) [9071.99.0052\(73_Z-0-0-52\)](#) [B88069X1973T902](#) [V20-1+NPE-280](#) [A9L15692](#)