



Surge Arresters

陶瓷气体放电管

SX6 Series

Gas Discharge Tubes - SX6 Series

Description

Gas discharge tubes (GDT) use noble gasses enclosed in ceramic tubes to provide an alternate circuit path for voltage spikes. The ceramic envelope and with nickel connectors allow for high loads. SX6 Gas Discharge Tubes (GDT) series has a surge rating of 5kA, 8/20 μ s. Offered in a Squared Surface Mount package, which helps to make pick and place on PCB process easier.

This GDT series is perfectly suited for broadband equipment applications. The GDT's low off-state capacitance is compatible with high bandwidth applications and this capacitance loading value does not vary if the voltage across the GDT changes.

SX6 Gas Discharge Tube (GDT) series are specifically designed for protection of electrical, multimedia, and communication equipment against over voltage transients in surface mount assembly applications.

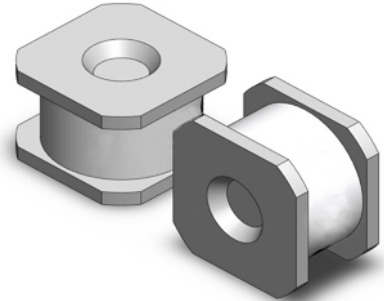

Electrical symbol

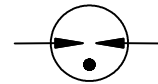

Features

- | Excellent response to fast rising transients
- | Stable breakdown voltage
- | GHz working frequency
- | 8/20 μ s Impulse current capability:5KA
- | Surface Mount package
- | Non-Radioactive
- | Ultra Low capacitance (<1.0pF)
- | Lead-free compliant
- | RoHS and REACH compliant
- | UL Recognized
- | Size: 4.2mm*6.2mm*6.2mm
- | Storage and operational temperature: -40~+90°C

Applications

- | | |
|--|------------------------------------|
| CATV equipment | Broad Band equipment |
| Antennas | xDSL, ADSL, ADSL2, VDSL, and VDSL2 |
| RS 485 | Medical Electronics |
| Telecom Base Station | Test Equipment |
| Power Supply AC Main | General Telecom Equipment |
| EV power Charging | Renewable Energy |
| Inverter/Variable (VFDs) | |
| Frequency Drivers | |
| IEEE 802.3 compliant Ethernet interfaces | |

Part Number Code

SX60 - 230X

SMDT

Series:

SX6系列: ϕ 6. 2*4
SX5系列: ϕ 5. 5*6

LeadType:

0=SMD
1=Thrust

DCLineVoltage:

90X=90V
102X=1000V

Package:

SMD=Cylinder No Lead
SMDT=2-SMD Cylinder Square End

Gas Discharge Tubes - SX6 Series

Electrical Characteristics

Part Number	DC Spark-over Voltage ^{1) 2)} @100V/S	Impulse Spark-over Voltage		Insulation Resistance ³⁾	Capacitance @1MHz	Life Ratings					
		100V/μS	1KV/μS			Impulse Discharge Current @8/20μS		AC Discharge Current @50Hz 1S	Impulse Life @10/1000μS 100A		
		Max	Max			Min	Max	Nominal ±5 times	Max 1 time	Nominal 5 times	Min
		V	V			V	GΩ	pF	KA	KA	A
SX60-75XSMDT	75±20%	500	600	1	1.0	5	10	5	300		
SX60-90XSMDT	90±20%	500	600	1	1.0	5	10	5	300		
SX60-150XSMDT	150±20%	500	600	1	1.0	5	10	5	300		
SX60-230XSMDT	230±20%	600	700	1	1.0	5	10	5	300		
SX60-250XSMDT	250±20%	600	700	1	1.0	5	10	5	300		
SX60-300XSMDT	300±20%	700	800	1	1.0	5	10	5	300		
SX60-350XSMDT	350±20%	750	850	1	1.0	5	10	5	300		
SX60-400XSMDT	400±20%	800	900	1	1.0	5	10	5	300		
SX60-470XSMDT	470±20%	800	900	1	1.0	5	10	5	300		
SX60-600XSMDT	600±20%	900	1000	1	1.0	5	10	5	300		
SX60-800XSMDT	800±20%	1300	1400	1	1.0	5	10	5	300		
Glow Voltage at 10mA.....				~60V							
Arc Voltage at 1A.....				~10V							
Glow to Arc transition Current.....				~0.3A							
Weight.....				~0.62g							
Operation and storage temperature.....				-40~+90°C							
Climatic category (IEC 60068-1).....				40/90/21							
Surface treatment.....				Matte-tin plated							

¹⁾ At delivery AQL 0.65 level II, DIN ISO 2859

²⁾ In ionized mode

³⁾ Insulation Resistance Measuring Voltage:

75V at DC 25V

90V~150V at DC 50V

Other at DC 100V

Terms in accordance with ITU-T Rec. K.12, IEC 61643-311, GB/T 9043.

Gas Discharge Tubes - SX6 Series

Dimensions

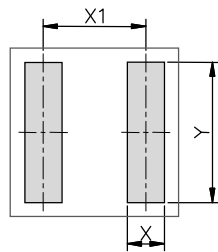
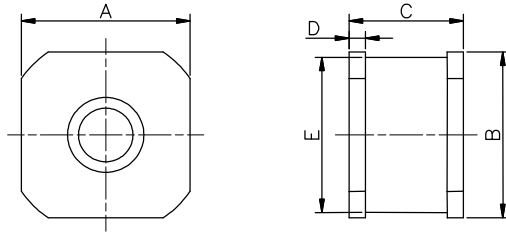

Recommended Soldering Pad Layout

Symbol	Millimeters	Inches
A	6.2±0.2	0.244±0.008
B	6.2±0.2	0.244±0.008
C	4.2±0.3	0.165±0.012
D	0.6±0.1	0.024±0.004
E	Φ6±0.1	Φ0.236±0.004
X	1.3	0.051
X1	3.5	0.138
Y	7.0	0.276

Taping and Reel Specifications

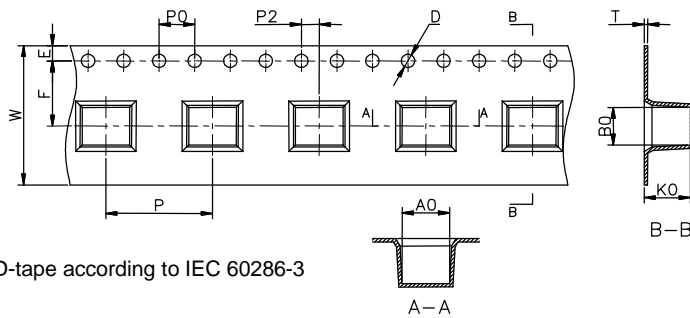

SMD-tape according to IEC 60286-3

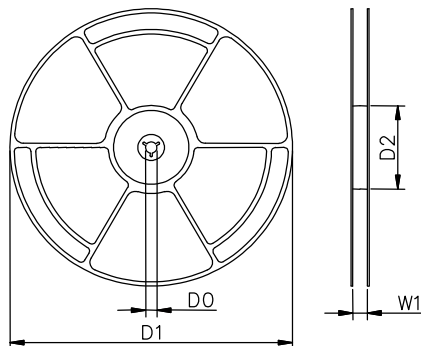

Symbol	Millimeters	Inches
W	16±0.3	0.630±0.012
A0	4.6±0.1	0.181±0.004
B0	6.5±0.1	0.256±0.004
K0	6.7±0.1	0.264±0.004
P	12±0.1	0.472±0.004
F	7.5±0.1	0.295±0.004
E	1.75±0.1	0.069±0.004
D	1.5+0.1/-0.0	0.059+0.004/-0.0
P0	4±0.1	0.157±0.004
P2	2±0.1	0.079±0.004
T	0.5±0.1	0.020±0.004
D0	13.3±0.15	0.524±0.006
D1	330±2	12.992±0.079
D2	100+1/-2	3.937+0.039/-0.079
W1	16.5±0.4	0.65±0.016

Packaging Quantity:

- 800 PCS per reel (13")
- 3 reels per inner box
- 2400 PCS per inner box

Gas Discharge Tubes - SX6 Series

Soldering Parameters - Reflow Soldering (Surface Mount Devices)

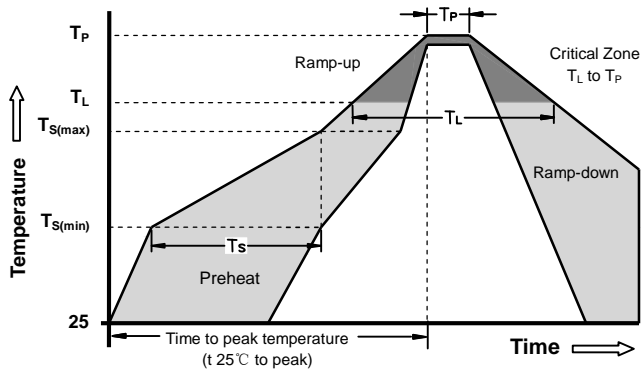

Reflow Condition		Pb - Free assembly
Pre Heat	-Temperature Min ($T_{s(min)}$)	150°C
	-Temperature Max ($T_{s(max)}$)	200°C
	- Time (min to max) (t_s)	60 -180 Seconds
Average ramp up rate (Liquids Temp T_L) to peak		3°C/second max
$T_{s(max)}$ to T_L - Ramp-up Rate		5°C/second max
Reflow	- Temperature (T_L) (Liquids)	217°C
	- Time (min to max) (t_s)	60 -150 Seconds
Peak Temperature (T_P)		260 +0/-5°C
Time within 5°C of actual peak Temperature (t_p)		10 - 30 Seconds
Ramp-down Rate		6°C/second max
Time 25°C to peak Temperature (T_P)		8 minutes Max
Do not exceed		260°C

X-ON Electronics

Largest Supplier of Electrical and Electronic Components

Click to view similar products for [Gas Discharge Tubes - GDTs / Gas Plasma Arrestors](#) *category:*

Click to view products by [SURGING](#) *manufacturer:*

Other Similar products are found below :

[PMT1023004](#) [PMT1025001](#) [RF3161-000](#) [PMT1035004](#) [PMT1040004](#) [PMT809006](#) [CG2250](#) [CG2800](#) [CG31.5L](#) [GT-SMD181240012-TR](#)
[WPGT-2N145B6L](#) [WPGT-2N230B6L](#) [WPGT-2N470B6L](#) [WPGT-2R470B6L](#) [WPGT-2RM230A6L](#) [WPGT-2RM350A6L](#) [WPGT-](#)
[2RM70A6L](#) [WPGT-2RM90A6L](#) [WPGT-2S145](#) [WPGT-2S350](#) [WPGT-2S470](#) [WPGT-3R350CF](#) [WPGT-3R350G1](#) [WPGT-3R90G1](#) [WPGT-](#)
[3R75G1](#) [WPGT-3R470G1](#) [WPGT-3R250C](#) [WPGT-3R230G1](#) [WPGT-2S230](#) [WPGT-2RM470A6L](#) [WPGT-2RM145A6L](#) [WPGT-2R3000B8L](#)
[WPGT-2R2700B8L](#) [WPGT-2R1000B8L](#) [WPGT-2N90B6L](#) [WPGT-2N70B6L](#) [WPGT-2N350B6L](#) [WPGT-2N230B6L1](#) [CG90](#) [CG2230](#)
[CG2145](#) [CG21000](#) [GT-SMD181215012-TR](#) [9071.99.0547 \(73_Z-0-0-547\)](#) [B88069X6940B152](#) [V20-1+NPE-280](#) [V20-3+NPE+FS-280](#)
[SD09-V24 9](#) [C50-0-255](#) [SG24PA300](#)