

Su'scon

2021-2022

ALUMINUM ELECTROLYTIC CAPACITORS



Environmental-Benefit



KUAN KUN ELECTRONIC ENTERPRISE CO., LTD.

ISO 9001 / ISO 14001 / ISO 45001 / IATF 16949 / IECQ-QC 080001

www.su-scon.com



蘇輝雄 總經理

Su'scon 冠坤電子擁有卓越的研發團隊與專業生產經驗，提供鋁質電解電容器、固態電容、半固態電容一系列完整的產品，以40多年來的專業技術，結合科技與產業未來發展趨勢，致力於配合開發客製產品以及提供全面性的解決方案，開發出強化客戶產品競爭力之電容器，成為客戶強而有力的後盾。

Building on the core values of "Innovation, Integrity, Efficiency" since our foundation in 1978, Su'scon specializes in comprehensive aluminum electrolytic capacitor solutions. We have been in pursuit for the best quality with spirit of continuous innovation; in pursuit of continuous management with continuous growth to meet our customers' expectations.

我們的產品應用領域相當廣泛，涵蓋照明、影音、通訊設備、醫療、家電、工業、汽車及綠色能源等，符合 AEC-Q200 標準，滿足來自全球市場的需求並提升服務品質與達成客戶滿意，共創雙贏。

We have supplied different kinds of Aluminum Electrolytic Capacitor with AEC-Q200 compliance for a wide range of applications, including lighting, automotive, white goods, Industrial power, medical, infrastructure, green energy, etc.

**POWERING
TOMORROW**

追求國際一流電容器大廠地位



多年來一直以高品質、高技術產品獲得全球客戶信賴，我們擁有領先研發能量與優秀研發人才的國際化團隊，提供客戶最佳服務，投入先進設備以確保優良品質增強客戶競爭優勢。

We have an excellent team who have the talent and ability in research and development, also invest in advanced equipment to offer excellent products that enhance our customer's competitive advantages.



Table of Contents

Page	Production Guide	產品指南
2~4	Series Index	系列索引
5	Explanation of parts numbers	料號說明
	Conductive Polymer Aluminum Electrolytic Capacitors	導電性高分子鋁電解電容產品
6~12	Precautions in using	使用注意事項
12	Environmental consideration	環境對策
13	Conductive Polymer Hybrid Series Chart of capacitor	導電性高分子混合型系列關係圖
14	Product Process Flow Chart	導電性高分子混合型生產流程圖
	Product specification of capacitor	導電性高分子混合型產品規格
15~18	Radial Type	引線型
19~28	Surface Mount Type	表面黏著型
29	Series Chart of solid electrolytic capacitor	導電性高分子固態電容系列關係圖
30	Product Process Flow Chart	導電性高分子固態電容生產流程圖
	Product specification of solid electrolytic capacitor	導電性高分子固態電容產品規格
31~50	Radial Type	引線型
51~69	Surface Mount Type	表面黏著型
70~71	Conductive Polymer Aluminum Electrolytic Capacitors Package Specification	導電性高分子鋁電解電容包裝規範
	Aluminum Electrolytic Capacitors	液態鋁電解電容產品
72~73	Series Chart of solid electrolytic capacitor	液態鋁電解電容系列關係圖
74~76	Precautions in using	液態鋁電解電容使用需知
77	Environmental consideration	液態鋁電解電容環境對策
81	Analysis of failure mode	液態鋁電解電容失效模式
82	Product Process Flow Chart	液態鋁電解電容生產流程圖
	Product specification of electrolytic capacitor	液態鋁電解電容產品規格
83~114	Surface Mount Type	表面黏著型
115~203	Radial Type	引線型
204~218	Anhydrous Type	低含水量型
219~247	Snap-In Type	基板自立型
248~251	LUG Terminal Type	LUG接腳型
252~263	Screw Terminal Type	螺絲型

Conductive Polymer Type

Polymer Hybrid Capacitors
Polymer Solid Capacitors

Surface Mount Type

Standard & Miniature

High Reliability

Radial Lead Type

Low Impedance

Non-Polarized & special

Anhydrous

Large Can Type



Conductive Polymer Hybrid Aluminum Electrolytic Capacitors

Series		Applications	Rated Voltage(V)	Capacitance Range(uF)	Temperature Range(°C)	Load Life (hrs)	Page	AEC-Q200 compliant
Radial Type	SPA	Low ESR	16~125	10~560	-55 to +105	5,000~10,000	15	●
	SPB	High temperature, Low ESR	16~50	15~560	-55 to +125	2,000~4,000	17	●
SMD Type	SVA	Low ESR	16~125	10~560	-55 to +105	5,000~10,000	19	●
	SVB	High temperature, Low ESR	16~125	10~560	-55 to +125	2,000~4,000	21	●
	SVV	High temperature,Low ESR , Anti-vibration	16~125	10~560	-55 to +105	10,000	23	●
	SVG	High temperature,Low ESR , Anti-vibration	16~125	10~560	-55 to +125	4,000	25	●
	SVT	High temperature 135°C,Low ESR	25~63	10~330	-55 to +135	1,000~2,000	27	●

Conductive Polymer Aluminum Solid Capacitors



Series		Applications	Rated Voltage(V)	Capacitance Range(uF)	Temperature Range(°C)	Load Life (hrs)	Page	AEC-Q200 compliant
Radial Type	EA	Standard	2.5~25	6.8~2,700	-55 to +105	2,000	31	
	EC	Ultra impedance, high ripple current	2.5~16	82~2,700	-55 to +105	2,000	34	
	EL	Long life	2.5~50	10~2,200	-55 to +105	5,000	37	
	EH	High voltage standard, high ripple current	35~100	12~470	-55 to +105	2,000	40	
	ET	High temperature, Low ESR	4~50	10~2,500	-55 to +125	1,000	42	
	EP	High temperature, Long Life	6.3~35	56~1800	-55 to +125	2,000	44	
	PC	Ultra impedance, high ripple current	2.5~63	10~2700	-55to+105	15000	46	
	PL	Long life Low ESR	2.5~50	10~2,200	-55to+105	20000	49	
SMD Type	VA	Standard	2.5~25	22~2,700	-55 to +105	2,000	51	
	VC	Low impedance, high ripple current	2.5~16	68~2,700	-55 to +105	2,000	54	
	VL	Long life, Low ESR, high ripple current	4~50	10~2,200	-55 to +105	5,000	56	
	VH	Low ESR, high voltage, High ripple current	35~100	12~220	-55 to +105	2,000	58	
	VT	High temperature, Low ESR	4~50	10~2,200	-55 to +125	1,000	60	
	VP	High temperature,Long life	6.3~35	56~1800	-55 to +125	2,000	63	
	PV	Ultra impedance, high ripple current	2.5~63	10~2700	-55to+105	15000	65	
	PH	Long life Low ESR	2.5~50	10~2,200	-55to+105	20000	68	

Aluminum Electrolytic Capacitor Surface Mount Type



Series		Applications	Rated Voltage(V)	Capacitance Range(uF)	Temperature Range(°C)	Load Life (hrs)	Page	AEC-Q200 compliant
Surface Mount	CS	Standard, 85°C	4~100	0.1~1,500	-55 to +85	2,000	83	
	CH	Standard, 105°C	4~50	0.1~1,500	-55 to +105	1,000	85	
	CK	Long life 105°C	6.3~50	0.1~1,000	-55 to +105	2,000	87	
	CN	Bi-Polarized	6.3~50	0.1~100	-55 to +85	1,000	89	●
	CD	Low impedance	6.3~100	1~1,500	-55 to +105	2,000~3,000	91	●
	CG	Long life 125°C	10~63 80~160	2.2~470	-55 to +125 -40 to +125	2,000~3,000	93	●
	CL	High voltage 400V	160~400	2.2~82	-40 to +105	2,000	95	●
	CKL	Long life,105°C	6.3~50	22~1000	-40 to +105	5,000	97	●
	CDL	Long life,105°C	6.3~100	22~1500	-55 to +105	5,000	99	●
	CGL	Low impedance,Long life,125°C	16~50	33~330	-40 to +125	3,000	101	●
	CGS	Low impedance,	6.3~100	1~4700	-55 to +125	1,000~2,000	103	●
	CGV	Low impedance,,Anti-vibration.	6.3~100	1~4700	-55 to +125	1,000~2,000	105	●
	CTS	Low impedance,Long life,125°C	16~50	33~2200	-40 to +125	2,000~5,000	107	●
	CTV	Low impedance,Long life,125°C,Anti-vibration	16~50	33~2200	-40 to +125	2,000~5,000	109	●
	CDS	Downsizing and Lower impedance,	6.3~50	22~2200	-55 to +105	2,000	111	●
CLL	Long life,Lower impedance,	6.3~50	10~1000	-25 to +105	7,000~10,000	113	●	

Aluminum Electrolytic Capacitor Radial Type



Series	Applications	Rated Voltage(V)	Capacitance Range(µF)	Temperature Range(°C)	Load Life (hrs)	Page	AEC-Q200 compliant	
Miniature	H5	5mm height, 105°C	4~50	0.1~220	-40 to +105	1,000	115	
	M5	5mm height, Low impedance	6.3~35	1~100	-40 to +105	1,000	117	
	SM	7mm height, 105°C	6.3~50	0.1~330	-40 to +105	1,000	119	
	MD	7mm height, Low impedance	6.3~35	6.8~220	-40 to +105	1,000	121	
	ST	7mm height, Long life	6.3~50	0.1~220	-40 to +105	5,000	123	
standard	SL	Standard, 85°C	6.3~250 350~500	0.1~33,000	-40 to +85 -25 to +85	2,000	125	
	LF	Long life, 85°C	400 450~500	10~150	-40 to +85 -25 to +85	8,000	128	
	SK	Standard, 105°C	6.3~250 350~500	0.1~22,000	-40 to +105 -25 to +105	2,000	130	
	SKA	High voltage, High ripple current	400 450~500	10~150	-40 to +105 -25 to +105	2,000	133	
	SKR	High ripple current	160~400 450	22~470	-40 to +105 -25 to +105	2,000	135	
	UK	High ripple current, 3000hrs	6.3~250 350~450	0.1~22,000	-40 to +105 -25 to +105	3,000	137	
High Reliability	SE	Long life, 5000hrs	6.3~250 350~450	0.47~22,000	-40 to +105 -25 to +105	3,000~5,000	139	
	SEA	High voltage, High ripple current	400 450~500	10~150	-40 to +105 -25 to +105	5,000	142	
	SER	Long life, High ripple current, 5000hrs	160~400 450	22~470	-40 to +105 -25 to +105	5,000	144	
	HE	Long life, 10000hrs	160~400 450	6.8~220	-40 to +105 -25 to +105	10,000	146	
	HU	Miniaturized and Long life	10~100	0.47~330	-25 to +105	10,000	149	
	HH	Long life, 12000hrs	160~400 450	6.8~680	-40 to +105 -25 to +105	10,000~12,000	151	
	SH	High reliability, 125°C	10~250 350~450	0.47~1,000	-40 to +125 -25 to +125	2,000	153	
	UH	High reliability, 130°C	10~250 350~450	1.8~4,700	-40 to +130 -25 to +130	2,000~3,000	155	
	HW	Long life, 20000hrs (ask engineering bulletin detail)	400~450	6.8~120	-25 to +105	15,000~20,000	-	
For ballast	HA	For ballast, 3000hrs	160~400 450	1~220	-40 to +105 -25 to +105	3,000	157	
	HB	For ballast, 5000hrs	160~400 450	1~220	-40 to +105 -25 to +105	5,000	159	
	HD	For ballast, 10000hrs	160~450	1~220	-25 to +105	10,000	161	
Low Impedance	NK	On the basis of SD series ripple promotion product	400~500	4.7~100	-40 to +105	3,000	163	
	SD	Low impedance	6.3~400 450	0.47~15,000	-40 to +105 -25 to +105	2,000	165	
	SDA	High voltage, High ripple current	400 450~500	10~150	-40 to +105 -25 to +105	2,000	168	
	MC	Low impedance, high ripple current	6.3~400 450	1~15,000	-40 to +105 -25 to +105	2,000~3,000	170	
	MF	Low impedance, high ripple current, than MC series	6.3~400 450	1~15,000	-40 to +105 -25 to +105	2,000~5,000	173	
	HF	Lower impedance	6.3~100	5.6~18,000	-40 to +105	4,000~8,000	176	
	SG	Lower impedance, high ripple current	6.3~50	22~6,800	-40 to +105	2,000~5,000	179	
	SX	Lower impedance, high ripple current	10~50	100~2,700	-40 to +105	4,000~5,000	181	
	MG	Lower impedance, high ripple current, than SG series	6.3~35	47~8,200	-40 to +105	5,000~6,000	183	
	HG	Low impedance, high ripple current, long life 10000hrs	6.3~100	6.8~18,000	-40 to +105	4,000~10,000	185	
	HX	Higher ripple current, long life 10000hrs	6.3~100	5.6~18,000	-40 to +105	6,000~10,000	190	
Non-Polarized	SN	Standard, 85°C	6.3~100	0.1~6,800	-40 to +85	2,000	193	
	HN	Standard, 105°C	6.3~160	0.1~1,000	-40 to +105	2,000	195	
	HR	Horizontal deflection current correction use	25, 35, 50, 100	2.2~10	-40 to +105	1,000	197	
Special	SA	Low Leakage current, 85°C	6.3~100	0.1~4,700	-40 to +85	2,000	198	
	SB	Low Leakage current, 105°C	6.3~100	0.1~4,700	-40 to +105	1,000	199	
	AK	For permissible abnormal voltage	200, 400	22~470	-25 to +105	2,000	200	
	YR	For audio equipment, 105°C	6.3~100	1~10,000	-40 to +105	2,000	202	

Aluminum Electrolytic Capacitor Anhydrous Type

Remark: Water content of Anhydrous Type
Low voltage: <1%
High voltage: <5%
Water content of electrolyte



Series	Applications	Rated Voltage(V)	Capacitance Range(uF)	Temperature Range(°C)	Load Life (hrs)	Page	AEC-Q200 compliant	
Anhydrous	SDN	Low impedance standard	6.3~100 160~400	0.47~15,000	-55 to +105 -40 to +105	2,000	204	●
	HFN	Lower impedance	6.3~50 63~100	5.6~18,000	-55 to +105 -40 to +105	4,000~8,000	207	●
	SGN	Lower impedance, high ripple current	6.3~50	22~6,800	-55 to +105	2,000~5,000	210	●
	HGN	Low impedance, high ripple current, long life 10000hrs	6.3~50 63~100	6.8~18,000	-55 to +105 -40 to +105	4,000~10,000	212	●
	SEN	High voltage, long life, 5000hrs	160~400	2.2~120	-25 to +105	3,000~5,000	217	●

Aluminum Electrolytic Capacitor Snap-in Type



Series	Applications	Rated Voltage(V)	Capacitance Range(uF)	Temperature Range(°C)	Load Life (hrs)	Page	AEC-Q200 compliant	
Snap-in Type	LX	Standard, 85°C	10~100 160~500	47~68,000	-40 to +85 -25 to +85	2,000	219	
	LXB	Standard, 85°C	"10~100 160~500"	47~68,000	-40 to +85	3000	222	
	LXA	Standard, 85°C	"10~100 160~500"	47~68,000	-40 to +85	5000	225	
	LZ	Standard, 105°C	10~250 350~500	68~68,000	-40 to +105 -25 to +105	2,000	228	
	HZ	Long life 3000hrs	16~250 350~450	47~47,000	-40 to +105 -25 to +105	3,000	232	
	MZ	Long life 5000hrs	10~100 160~450	82~47,000	-40 to +105 -25 to +105	5,000	235	
	TZ	Long life 10000hrs	200~450	220~1800	-25 to +105	10,000	240	
	AZ	For over voltage vent operation test	200, 400, 420	33~1,200	-25 to +105	2,000	242	
	AU	Snap-in Type, For audio equipment, 105°C	16~250 400~450	56~33,000	-40 to +105 -25 to +105	2,000	244	

Aluminum Electrolytic Capacitor LUG Terminal Type



Series	Applications	Rated Voltage(V)	Capacitance Range(uF)	Temperature Range(°C)	Load Life (hrs)	Page	AEC-Q200 compliant	
LUG Terminal	LM	Standard, 85°C	16~250 315~450	68~150,000	-40 to +85 -25 to +85	2,000	248	
	LG	Standard, 105°C	16~250 315~450	22~10,000	-40 to +105 -25 to +105	2,000	250	

Aluminum Electrolytic Capacitor Screw Terminal Type



Series	Applications	Rated Voltage(V)	Capacitance Range(uF)	Temperature Range(°C)	Load Life (hrs)	Page	AEC-Q200 compliant	
Screw Terminal	LP	Standard, 85°C	16~250 350~500	470~500,000	-40 to +85 -25 to +85	3,000	252	
	LS	85°C High ripple current	350~500	1,000~150,000	-25 to +85	5,000	255	
	LV	85°C High voltage	500~650	470~500,000	-25 to +85	5,000	257	
	LW	85°C Long life 10,000hrs	350~450	1,000~15,000	-25 to +85	10,000	259	
	HP	Long life, 105°C	10~100 160~450	220~1,000,000	-40 to +105 -25 to +105	2,000~5,000	261	

Remark:

1. Surface Mount Type, Polymer Hybrid Type, Anhydrous Type 符合 AEC-Q200 標準，適用於車載產品。
2. 規格料號，在末端加註 "A" 碼字樣，以表示車載專用料號。

Explanation of Parts Numbers

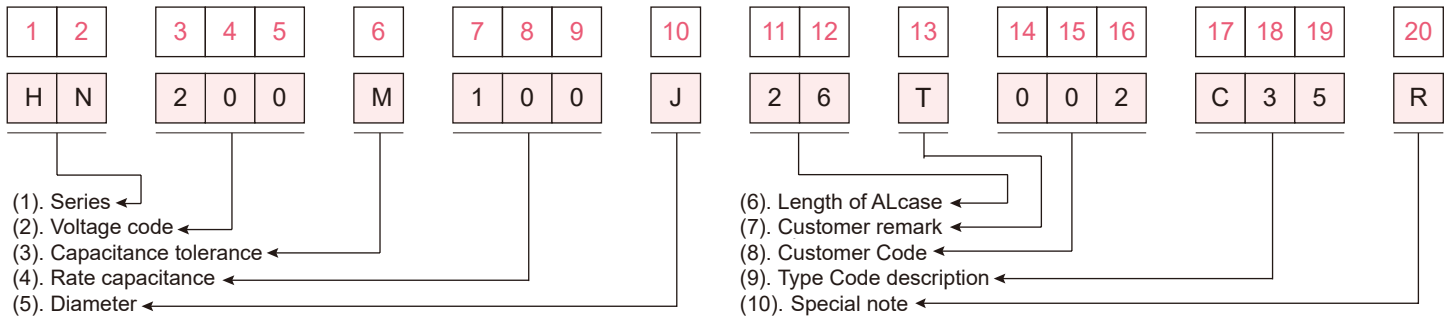

(1). Series Code:
For details, Please view Page 2, 3, 4 "Series index" table

(2). Voltage Code:

Voltage(V)	4	6.3	10	16	25	35	50	63	80	100	160
Code	004	006	010	016	025	035	050	063	080	100	160
Voltage(V)	180	200	250	315	330	350	400	420	450	500	
Code	180	200	250	315	330	350	400	420	450	500	

(3). Capacitance Tolerance

Tolerance(%)	-5~+15	±10	±20	-0~+20	-0~+40	-0~+50	-5~+20	-5~+5	-5~+10	-25~+20	-10~-30
Code	C	K	M	A	S	R	D	J	H	L	F
Tolerance(%)	-10~+20	-10~+30	-10~+50	-15~+20	-30~+20	+10~+30	+10~+25	-20~0	+5~+20	-20~+100	-6.5~+20
Code	V	Q	T	E	I	B	N	G	P	X	Y

(4). Capacitance Code

Capacitance	0.1	1	10	100	1000	10000	100000	22000
Code	0R1	1R0	100	101	102	103	104	223

(5). Diameter

Diameter	3	4	5	6.3	8	10	12	12.5	13	14.5	16	18
Code	B	C	D	E	F	G	H	X	I	Y	J	K
Diameter	20	22	25	30	35	40	51	64	76	90	100	
Code	L	M	N	O	P	Q	R	S	T	U	V	
Diameter	42	25.4	14	15.5	21	33	7.5	45	5.5			
Code	W	Z	1	2	3	4	7	8	5			

(6). Length rule for Aluminum case

Length	5	5.4	7	12	13.5	25	105	125	136	155	185	195	200
Code	05	5A	07	12	DB	25	A5	C5	D6	F5	I5	J5	K0

(7). Customer remark

This code to distinction when customers have special requirements.

(8). Customer Code

(9). Type Code Description

A. Radial and V-chip code:

Code 17 for processing method, code 18, 19: Refer to Page. "Lead Cutting and Forming".

Description	Long lead	Lead cut	Lead cut and Crimp	Lead cut, Crimp and Form	Lead cut and Form	Forming
Code	S	C	D	H	F	B
Description	Lead cut and bending (+)	Lead cut and bending (-)	Taping (Ammo pack)	Tape and Reel	V-chip type(SMD)	
Code	Z	L	P	R	V	

B. Terminal Diagram Code for Snap-in, LUG and Screw Terminal

Description	Snap-in long terminal	Snap-in short terminal	LG Type terminal	Straight type terminal	PC board pin-out straight terminal
Code	YL	YS	G	ST	PCS
Description	PC board pin-out terminal	PC board pin-out U-insert terminal	PC board pin-out bend terminal	5 pin straight terminal	screw terminal
Code	PCY	PCU	PCB	U	W

(10). Special note:

R: Generally component and RoHS compliance code
A: Automotive component and RoHS compliance code

■ 導電性高分子鋁電解電容使用注意事項 (Solid & Hybrid)



一、回路設計上的注意事項

1. 極性
導電性高分子鋁電解電容是有正極和負極。使用時，切勿錯置極性。若極性錯置，使用時將會增加漏電流或減少使用壽命。
2. 禁止使用的回路
導電性高分子鋁電解電容的漏電流在以下條件有可能會增大。
 - (a) 鍍焊錫時
 - (b) 經過無外加電壓的高溫無負荷、高溫高濕無負荷、冷熱沖擊試驗等，漏電流也有增大的可能。

以下回路有可能出現故障，請禁止使用

 - (a) 高阻抗回路
 - (b) 藕合回路
 - (c) 時間恆定回路
 - (d) 有關漏電流變化而影響回路工作的情況

▲為提高耐電壓而將兩個以上的導電性高分子鋁電解電容串聯連接使用時，請與我們聯絡。
3. 電路設計
請確認在以下內容的基礎上進行電路設計。
 - (a) 隨著溫度及頻率的變化，電容器的電氣特性會隨之變化。請確認在這些變化之後進行電路的設計。
 - (b) 當並聯2個以上的電容器時，請在設計電路時考慮電流的平衡
 - (c) 當串聯2個以上的電容器時，因載入電壓存在差異，有可能加載過電壓,請使用的時候另行諮詢我們。
4. 確認使用環境溫度、電壓和紋波電流
 - (a) 使用溫度應控制在出廠規格書規定的使用溫度範圍內
 - (b) 超過額定電壓的過電壓將會發生短，因此,即使是瞬間也不得外加過電壓
 - (c) 不得接通超過額定的紋波電流若接通過大的紋波電流，將會增高內部發熱，減少使用壽命

■ Precautions In Using(Solid & Hybrid)



一、Precautions for circuit designing

1. Polarity
Conductive Polymer Aluminum Electrolytic Capacitors have the positive and negative electrodes. Using reversed polarity may cause leakage current increased or life span decreased.
2. Prohibited circuits
Conductive Polymer Aluminum Electrolytic Capacitors leakage current may become larger as the following conditions.
 - (a) Soldering
 - (b) High temperature no-load test, high temperature and high humidity no-load test, rapidly changing temperature test, etc.

Avoid the use of Conductive Polymer Aluminum Electrolytic Capacitors in the following type of circuits because leakage current may increase.

 - (a) High-impedance circuits
 - (b) Coupling circuits
 - (c) Time constant circuits
 - (d) Other circuits that are significantly affected by leakage current

▲ If you plan to use 2 or more Conductive Polymer Aluminum Electrolytic Capacitors in a series connection, please contact us before use.
3. Circuit Design
Verify the following before designing the circuit:
 - (a) The electrical characteristics of the capacitor will vary depending on differences in temperature and frequency. Only design your after verifying the scope of these factors.
 - (b) When connecting two or more capacitors in parallel ensure that the design takes current balancing into account.
 - (c) When two or more capacitors are connected in series, variability in applied voltage may cause over-voltage conditions. Contact Su'scon before using capacitors connected in series.
4. Operating temperature、voltages and ripple current
 - (a) Operating temperature must be under the category temperature range of specification.
 - (b) Do not apply voltages exceeding the full rated voltage.
 - (c) Do not apply currents that excess the rated ripple current. When excessive ripple current is applied, the Conductive Polymer Aluminum Electrolytic Capacitors may result in shorter life due to the internal heat increase.

1. 快速充放電的限制

急速充放電所導致過大的衝擊電流將會造成短路或增加漏電流。以下條件時，應使用保護回路。

(a) 衝擊電流超過10A

(b) 超過所用導電性高分子鋁電解電容額定紋波電流值10倍

▲測試漏電流時，務必插入1kΩ的保護電阻，進行充電和放電。

2. 故障

最高使用溫度範圍、外加電壓範圍時，基於JIS C 5003標準(可信度水準60%) 0.5%/1000小時。以下為導電性高分子鋁電解電容的主要故障模式。

6-1. 偶發故障

1. 產品溫度上升引起的靜電容量減少及ESR的上升引起的開路模式磨損是主要的故障模式。有時候也會偶發因過大電壓和超大電流導致的短路模式

2. 通過降低周圍溫度、紋波電流、加載電壓可以減少故障率。

3. 由於加載超過額定電壓的電壓引起短路和通電電流過大的時候、會因內壓的上升而使得膠蓋膨脹或剝落，發出臭氣。

4. 構成產品的材質中含有可燃物質，短路部位有可能因為電火花等而起火。產品的安裝方法、位置、圖形設計等請考慮以下設計方面的注意點，以確認絕對的安全

A. 設置保護電路、保護裝置，確保絕對的安全

B. 設置備用電路等，以便設備不會因為單個的故障而不穩定。

6-2. 使用中的電氣特性變動及磨耗故障(使用壽命)

導電性高分子鋁電解電容即使在出廠規格書記載的額定，電性能和機械性能的範圍內使用，也會在各自性能規定的範圍內發生靜電容量減少，等效串聯電阻增大等電氣特性的變動，設計時應予以注意。至於磨耗故障，主要是超過信賴性和高溫高濕保障時間後，這類電氣特性的變動進而增大，最終形成電解質的絕緣化(劣化)，成為開放模式。

6-3. 壽命時間推算

A: $L_x = L_0 \times 10^{(T_0 - T_x)/20}$ B: $L_x = L_0 \times 2^{(T_0 - T_x)/10}$

LX：實際使用推算的壽命值

L0：保證壽命值

Tx：裝置內的電容器實際環境溫度

A	B
EA, EC, EL, EH, EP, VA, VC, VL, VH, VT, VP	PC, PL, PV, PH 與鋁電解電容壽命計算一樣
105°C ≥ 2,000hrs	105°C ≥ 2,000hrs
95°C ≥ 6,324hrs	95°C ≥ 4,000hrs
85°C ≥ 20,000hrs	85°C ≥ 8,000hrs
75°C ≥ 63,245hrs	75°C ≥ 16,000hrs

1. Sudden charge and discharge

An excessive surge current by sudden charge or discharge may result in a short circuit or a large leakage current. Protection circuits are recommended to retain high reliability in case of the following conditions.

(a) The surge current value exceeds 10A

(b) The value exceeds 10 times of the rated ripple current

▲ When you measure leakage current, a protection resistor of approximately 1k Ω must be inserted to the circuit before charge and discharge.

2. Failure

The failure rate is 0.5% / 1000h (with a 60% reliability standard) based on JIS C 5003.

The mainly failure modes are as follows.

6-1. Contingency failure

1. The product of electrostatic capacitance decrease caused by temperature rise and the rise of the ESR open mode caused by the wear that is the main failure mode. Sometimes accidental short-circuit caused by excessive voltage and large current mode

2. Decrease the failure rate we can reduce ambient temperature, ripple current and use voltage.

3. When the load voltage exceeds the rated voltage will cause a short circuit or ripple current is too large, internal pressure increased and the rubber expansion or peeling, smelliness

4. The installation method of products, Position, Graphic design please consider the following points to ensure the safety

A. Set the protection circuit and Protector to ensure the safety.

B. Setting a redundant circuit, so that the equipment will not be unstable because of a single fault.

6-2. Wear-out failure (life-span)

When life span exceeded the specified guarantee time of Endurance and Damp heat, electrolyte might insulate and cause electric characteristic changed. This is called an open circuit. The electric characteristics of capacitance and ESR may possibly change within the specified range in specifications when it is used under the condition of the rated voltage, electric and mechanical performance. Please note it when design.

Lifetime (hours) of the capacitor to be estimated:

A: $L_x = L_0 \times 10^{(T_0 - T_x)/20}$ B: $L_x = L_0 \times 2^{(T_0 - T_x)/10}$

Lifetime (hours) of the capacitor to be estimated. (15 Years Life is Maximum)

Base lifetime (hours) of the capacitor

Actual ambient temperature (°C) of the capacitor

A	B
EA, EC, EL, EH, EP, VA, VC, VL, VH, VT, VP	PC, PL, PV, PH is similar to the lifetime estimation of Al electroly capacitor
105°C ≥ 2,000hrs	105°C ≥ 2,000hrs
95°C ≥ 6,324hrs	95°C ≥ 4,000hrs
85°C ≥ 20,000hrs	85°C ≥ 8,000hrs
75°C ≥ 63,245hrs	75°C ≥ 16,000hrs

二、安裝的注意事項

1. 漏電流

漏電流因焊接的熱應力及輸送等機械性應力的影響而有增大的可能在這種情況下，若在導電性高分子鋁電解電容的最高使用溫度範圍以下外加電壓，則漏電流將會逐漸變小。在接近最高使用溫度範圍的狀態下，越是外加額定電壓以下的高電壓，越會加快漏電流的修復速度。

漏電流回升的原因

- a. 焊接
- b. 高溫無負荷、高溫高濕、溫度急劇變化等試驗。

2. 電容器的絕緣

- (a) 外殼和負極端子之間有不穩定的電阻，未經絕緣處理，應予以注意
- (b) 外殼，負極電極端子，正極電極端子及線路結構之間的電路應完全隔離

3. 使用環境的限制

不得在下列環境下使用

- (a) 直接濺水、鹽水、油或結露狀態下的環境
- (b) 充滿有害氣體(硫化氫，亞硫酸，亞硝酸，氯，氨等)的環境
- (c) 受臭氧，紫外線，放射線照射的環境

4. 印刷電路板的設計

- (a) 避免在導電性高分子鋁電解電容周圍及印刷電路板背面安裝發熱元件
- (b) 貼裝型應按照技術手冊或出廠規格書記載的建議條件，設計印刷電路板接合區結構的電路
- (c) 插裝型應按照技術手冊或出廠規格書記載的產品尺寸公差，設計安裝的基板孔及孔徑

5. 並聯連接

導電性高分子鋁電解電容與其他電容器並聯連接使用時，流入導電性高分子鋁電解電容的紋波電流將會增多，選購時應予以注意。

6. 其他

確認以下內容後，再設計電路

- (a) 電氣特性隨著溫度和頻率的變動而變化。設計前，應先掌握這一變化部份
- (b) 在雙面基板上安裝導電性高分子鋁電解電容時，多餘的基板孔和基板正反面連接用通孔不要位於導電性高分子鋁電解電容的下方

二、Caution For Assembling Capacitors

1. Leakage Current

Mechanical stress may cause Conductive Polymer Aluminum Electrolytic Capacitors leakage current increased. In such a case, leakage current will gradually decrease by applying voltage within the category voltage and the upper category temperature. Then, self-healing speed of leakage current is faster when it is near to the upper category temperature and the category voltage.

The cause of Leakage current rise again

- a. soldering
- b. High Temp shelf、High Temp High Humidity and Temp rapid change etc.

2. Capacitor insulation

- (a) The space between the case and the negative electrode terminal is insulated and has some resistance.
- (b) Be sure to completely separate the case, negative lead terminal, positive lead terminal and PC board patternst.

3. Operating environmental restrictions

Do not use the Conductive Polymer Aluminum Electrolytic Capacitors in the following environments.

- (a) Places where water, salt water or oil can directly fall on it, and places where condensation may form.
- (b) Places filled with noxious gas (hydrogen sulfide, sulfurous acid, nitrous acid, chlorine, ammonia, etc.)
- (c) Places susceptible to ozone, ultraviolet rays and radiation.

4. PCB design

- (a) Avoid locating heat-generating components around the Conductive Polymer Aluminum Electrolytic Capacitors and on the underside of the PC board.
- (b) For the surface mount capacitor, design the copper pads on the PC board in according with the recommended land pattern or dimensions in the series specifications.
- (c) For radial capacitor, design the terminal pitch and hole size after conforming the dimensional tolerance in the series specifications.

5. Parallel connection

A large amount of ripple current may be applied to the Conductive Polymer Aluminum Electrolytic Capacitors when it is used in parallel with another capacitor. Carefully select the type of capacitor.

6. Others

Design circuits after checking the following items.

- (a) Electric characteristics are affected by temperature or frequency fluctuations. Design circuits after checking the changes.
- (b) When mounting an Conductive Polymer Aluminum Electrolytic Capacitors on a double-sided PC board, extra PC board holes or the through holes for connecting the front and back of the PCB must not exist underneath the Conductive Polymer Aluminum Electrolytic Capacitors .

三、實際安裝時的注意事項

1. 焊接時的注意事項

焊接條件應控制在出廠規格書規定的範圍內。若採用規定以外的嚴格焊接條件，因電氣特性的劣化或在最壞的情況下，可導致外觀不良、漏電流增加及容量減少。

2. 安裝前的預備知識

(a) 導電性高分子鋁電解電容安裝在設備上開通電後，不得重新使用。除了定期檢修時為測試電氣性能而卸下的導電性高分子鋁電解電容以外，不得重新使用。

(b) 長期保存的導電性高分子鋁電解電容有時會增加漏電流。遇這種情況，應通過約1kΩ的電阻進行施加電壓處理。此時的電壓處理，推薦在約60~70°C下外加1小時額定電壓。

3. 安裝-1

(a) 先確認額定靜電容量和額定電壓後，再進行安裝。

(b) 小心操作，不要摔落。摔落的導電性高分子鋁電解電容不得使用。

(c) 安裝時不要使其變形。

(d) 安裝時不要破壞鋁殼表面皮膜。

4. 安裝-2

(a) 避免在導電性高分子鋁電解電容周圍及印刷電路板背面安裝發熱元件。

(b) 貼裝型應按照技術手冊或出廠規格書記載的建議條件，設計印刷電路板接合區結構的電路。

(c) 插裝型應用及技術手冊或出廠規格書記載的產品尺寸公差，設計安裝的基板孔及孔徑。

5. 使用電烙鐵時的焊接條件

(a) 請在以下焊接條件(溫度、時間)範圍內使用。

條件	電烙鐵溫度	時間
焊接條件	380±10°C	within 5s.

(b) 焊接插裝型時，若電極端子間距和印刷電路板孔間距不符而需要修整電極端子(引線端子)時，應在焊接前避免對導電性高分子鋁電解電容體施加應力的情況下修整。

(c) 使用電烙鐵焊接時，注意不要對導電性高分子鋁電解電容主體施加過度應力。

(d) 焊接後需要卸下導電性高分子鋁電解電容，用電烙鐵修正焊接狀態時，應先充分熔化焊料，防止對導電性高分子鋁電解電容的電極端子施加應力。

(e) 電烙鐵頭不得接觸導電性高分子鋁電解電容主體。

三、Precautions for mounting on-board

1. Considerations when soldering

The soldering conditions as soldering iron, flow soldering, reflow soldering should be under the range prescribed in specifications. If the specifications are not followed, there is a possibility of the cosmetic deflection, the intensive increase of leakage current or the capacitance reduction.

2. Capacitor insulation

(a) Do not reuse Conductive Polymer Aluminum Electrolytic Capacitors that have been assembled in a set and energized. Excluding Conductive Polymer Aluminum Electrolytic Capacitors that have been removed for measuring electrical characteristics during a periodic inspection, Conductive Polymer Aluminum Electrolytic Capacitors cannot be reused.

(b) Leakage current may increase when Conductive Polymer Aluminum Electrolytic Capacitors are stored for long term. In this case, we recommend that you apply the rated voltage for 1 hour at 60°C~70°C with a resistor load of 1kΩ.

3. Mounting-1

(a) Mount after checking the capacitance and the rated voltage.

(b) Do not drop Conductive Polymer Aluminum Electrolytic Capacitors on the floor and do not use it that is dropped.

(c) Do not mount Conductive Polymer Aluminum Electrolytic Capacitors that is deformed.

(d) Do not break aluminum case surface coating in mounting

4. Mounting-2

(a) Avoid locating heat-generating components around the Conductive Polymer Aluminum Electrolytic Capacitors and on the underside of the PC board.

(b) For the surface mount capacitor, design the copper pads on the PC board in according with the recommended land pattern or dimensions in the series specifications.

(c) For radial capacitor, design the terminal pitch and hole size after conforming the dimensional tolerance in the series specifications.

5. Soldering with a soldering iron

(a) Soldering condition should be under the following ranges.

Conditions	Soldering iron temperature	Time
Soldering condition	380±10°C	within 5s.

(b) When the lead terminal for radial lead type must be processed because the lead pitch and the PCB holes in spacing do not match, process it without any stresses to Conductive Polymer Aluminum Electrolytic Capacitors.

(c) Solder without any excessive stresses to Conductive Polymer Aluminum Electrolytic Capacitors itself.

(d) When an Conductive Polymer Aluminum Electrolytic Capacitors has been soldered once and needs to be removed, remove it after the solder has been completely melted.

(e) Do not let the tip of the soldering iron touch the Conductive Polymer Aluminum Electrolytic Capacitors itself.

1. 正流焊接條件

(a) 請在以下焊接條件(溫度、時間)範圍內使用。
正流焊推薦條件

條件	溫度	時間	次數
預熱	120°C以下(環境)	120秒以下	1次
焊接條件	260±5°C以下	10 + 1秒以下	2次以下 ※1

※1. 進行2次時，焊料的浸漬時間合計為10+1秒以下。

- (b) 貼裝型導電性高分子鋁電解電容不適用於波峰焊。
- (c) 不要將導電性高分子鋁電解電容主體浸漬在溶解焊料中。焊接部位只限於印刷電路板上與導電性高分子鋁電解電容相反的一側。
- (d) 松脂不要貼附在電極端子以外的部位。
- (e) 焊接時，注意不要碰倒其他元件，以免碰觸導電性高分子鋁電解電容。

2. 回流焊接條件

(a) 請在以下焊接條件(溫度、時間)範圍內使用。
回流焊推薦條件

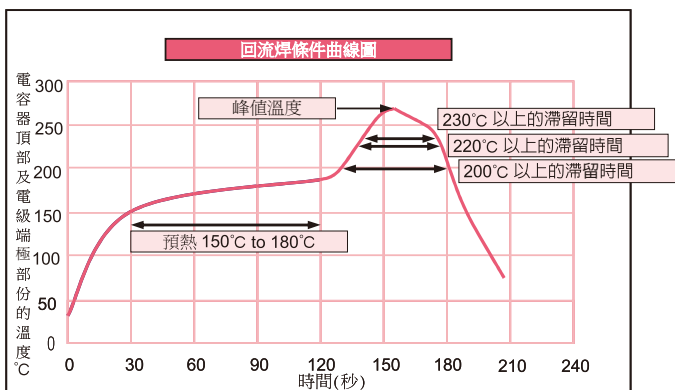

※峰值溫度:電容器頂部及電極端子部的溫度。

(b) 導電性高分子混合型鋁電解電容

電壓範圍(V)	16~63	80~125
峰值溫度	260°C, 5秒以下	250°C, 5秒以下
預熱溫度	120秒以內	120秒以內
200°C以上停留時間	100秒以內	100秒以內
220°C以上停留時間	80秒以內	80秒以內
230°C以上停留時間	40秒以內	40秒以內
回流次數	2次以下	2次以下

(c) 導電性高分子固態鋁電解電容

項目	Polymer系列	
峰值溫度	250°C以下	260°C以下
預熱溫度	150°C~180°C 90±3秒	
200°C以上停留時間	60秒以內	60秒以內
220°C以上停留時間	50秒以內	50秒以內
230°C以上停留時間	40秒以內	40秒以內
回流次數	2次以下	1次

※以上如需兩次回流焊，需在第一次回流焊後放置1小時以上讓部品恢復常溫(5~35°C)才可進行。

1. Flow soldering

(a) Soldering condition should be under the following ranges.
Recommended flow soldering condition

Conditions	Temperature	Time	Flow number
Preheating	120°C or less(ambient temperature)	120 sec. or less	1 time
Soldering conditions	260 + 5°C or less	10 + 1 sec. or less	2 times or less ※1

※1. When soldering 2 times, immersion time should be 10 + 1 sec. or less.

- (b) Do not apply flow soldering to SMD type.
- (c) Do not solder Conductive Polymer Aluminum Electrolytic Capacitors itself by submerging it in melted solder. Solder the opposite side that the Conductive Polymer Aluminum Electrolytic Capacitors is mounted on.
- (d) Note that flux does not adhere to anywhere expect the lead terminal.
- (e) Note that other components do not fall over and touch the Conductive Polymer Aluminum Electrolytic Capacitors when soldering.

2. Reflow soldering

(a) Soldering condition should be under the following ranges.
Recommended reflow soldering condition

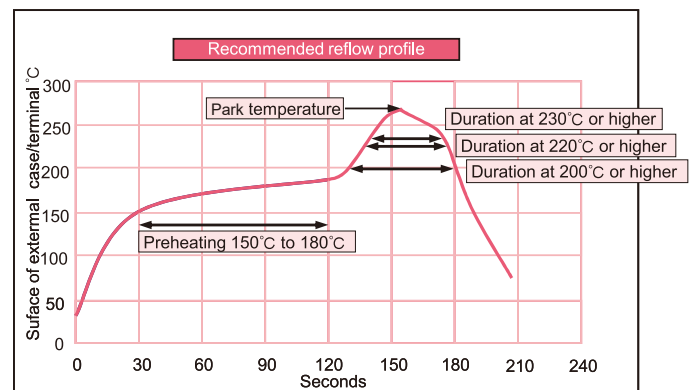

※All temperatures are measured on the topside of the Al-can and terminal surface.

(b) Conductive Polymer Hybrid Aluminum Electrolytic Capacitors

Voltage Range(V)	16~63	80~125
Peak Temperature	260°C, 5sec. max.	250°C, 5sec. max.
Preheat Temperature	120 sec. max.	120 sec. max.
Duration at 200°C or higher	100 sec. max.	100 sec. max.
Duration at 220°C or higher	80 sec. max.	80 sec. max.
Duration at 230°C or higher	40 sec. max.	40 sec. max.
Reflow number	twice or less	twice or less

(c) Conductive Polymer Aluminum Solid Capacitors

Item	Polymer系列	
Peak Temperature	250°C or less	260°C or less
Preheat Temperature	150°C~180°C 90±3sec.	
Duration at 200°C or higher	60 sec. max.	60 sec. max.
Duration at 220°C or higher	50 sec. max.	50 sec. max.
Duration at 230°C or higher	40 sec. max.	40 sec. max.
Reflow number	twice or less	only 1 time

※Reflow should be performed twice or less. Please ensure that the capacitor became cold enough to the room temperature (5 to 35°C) before the second reflow.

(d) 插裝(DIP)型導電性高分子鋁電解電容不適用於回流焊。

(e) 建議焊點尺寸。

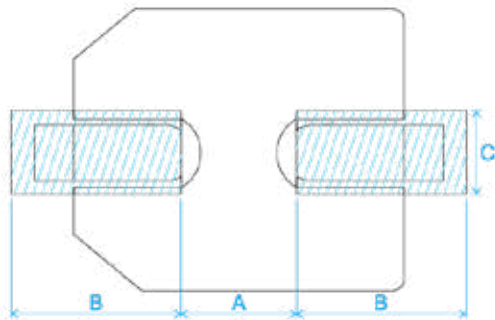

(d) Do not apply reflow soldering to Radial Lead type.

(e) RECOMMENDED LAND PATTEND DIMENSION OF PCB

ϕD	a	b	c
$\phi 5$	1.4	3.0	1.6
$\phi 6.3$	1.9	3.5	1.6
$\phi 8$	3.1	4.2	2.2
$\phi 10$	4.5	4.4	2.2
$\phi 10(G)$	3.8	4.8	4.1

"(G)" "Anti-vibration Structure".

3. 焊接後注意事項

- (a) 焊接在線路板上後，不得傾斜，扳倒，扭曲導電性高分子鋁電解電容。
- (b) 焊接在線路板上後，不得用導電性高分子鋁電解電容代替把手移動基板。
- (c) 焊接在線路板上後，注意不要碰撞導電性高分子鋁電解電容。堆放基板時，注意不要使導電性高分子鋁電解電容接觸基板或其他元件。
- (d) 焊接在線路板上後，不得對導電性高分子鋁電解電容施加過度應力。

4. 清洗基板

可使用Pine- α ST-00S、Clean thru750H、750L、710M、750K、Techno CareFRW14~17等高級乙醇類清洗劑或AK-225ES等氟利昂替代品，IPA等清洗劑清洗，清洗時，應確認以下內容。

- (a) 採用浸漬，超聲波等清洗方式時，清洗時間合計應控制在2分鐘以內。
- (b) 清洗液溫度請控制在60°C以下。
- (c) 要進行清洗液的防污染管理(導電度、PH值、比重、含水量等)。
- (d) 清洗後，不要在清洗液環境中或密封容器中保管。
- (e) 用熱風(請在使用溫度範圍以下進行)烘乾基板和導電性高分子鋁電解電容時，些許的清洗劑其液附在電容器表面上，若擦拭可抹去電容器上的標記，應予以注意。
- (f) 關於清洗劑和清洗方法等詳細情況以及使用其他種類的清洗劑時，請事先與本公司洽詢。

3. Handling after soldering

- (a) Do not tilt, bend or twist Conductive Polymer Aluminum Electrolytic Capacitors.
- (b) Do not move the PCB with catching Conductive Polymer Aluminum Electrolytic Capacitors itself.
- (c) When stacking PCBs, make sure that the Conductive Polymer Aluminum Electrolytic Capacitors does not touch other PCBs or components.
- (d) Do not dump the Conductive Polymer Aluminum Electrolytic Capacitors with objects.

4. Cleaning PCB

Check the following items before washing PC board with these detergents: high quality alcohol-based cleaning fluid such as Pine- α ST-100S, clean thru 750H, 750L, 710M, 750K or Techno Care FRW 14 through 17 or detergents including substitute Freon as AK-225AES or IPA.

- (a) Use immersion or ultrasonic waves to clean within 2 minutes on polymer conductive type.
- (b) The temperature of the cleaning fluid should be less than 60°C.
- (c) Watch the contamination of the detergent as conductivity, ph, specific gravity, water content, etc.
- (d) Do not store the Conductive Polymer Aluminum Electrolytic Capacitors in a location subject to gases from the cleaning fluid or in an airtight container after cleaning.
- (e) Dry the PCB or Conductive Polymer Aluminum Electrolytic Capacitors with hot air that should be less than the maximum operating temperature. Please note that Indication may disappear when rubbing print side after washing as a cleaner.
- (f) Please contact us for details about detergents, cleaning methods and about detergents other than those listed above.

10. 固定劑和塗層劑

- (a) 選擇適合於導電性高分子鋁電解電容外裝材質和封裝材質的材料。特別是固定劑和塗層劑或稀釋劑中不得含有丙酮。
- (b) 使用固定劑和塗層劑前，清除基板和導電性高分子鋁電解電容封裝部之間的焊裝劑殘渣和污垢。
- (c) 使用固定劑和塗層劑前，烘乾清洗劑等。
- (d) 請洽詢固定劑和塗層劑的熱固化條件。

10. Fixatives and coating materials

- (a) Select the appropriate covering and sealant materials for onductive Conductive Polymer Aluminum Electrolytic Capacitors. In particular, make sure the fixative, coating and thinner do not contain acetone.
- (b) Before applying a fixative or coating, completely remove any flux residue and foreign matter form the area where the board and Conductive Polymer Aluminum Electrolytic Capacitors will be jointed together.
- (c) Allow any detergent to dry before applying the fixative or coating.
- (d) Please contact us for fixative and coating heat curing conditions.

■ 環境物質對應 對應 RoHS 法規

環境管理物質名	化學物質記號	環境對應 (ppm)
鎘以及鎘化合物	Cd	100
鉛以及鉛化合物	Pb	1000
汞以及汞化合物	Hg	1000
六價鉻化合物	Cr6+	1000
聚溴聯苯	PBBs	1000
聚溴二苯醚	PBDEs	1000
鄰苯二甲酸二正丁酯	DBP	1000
鄰苯二甲酸苯基丁酯	BBP	1000
鄰苯二甲酸二(2-乙基己基)酯	DEHP	1000
鄰苯二甲酸二異丁酯	DIBP	1000

■ Environmental Consideration Compliance with RoHS Directive

Substance	Symbol	Maximum Limit (ppm)
Cadmiun and Cadmium Compounds	Cd	100
Lead and Lead Compounds	Pb	1000
Mercury and Mercury Compounds	Hg	1000
Hexavalent Chromium Compounds	Cr6+	1000
Polybrominated Biphenyls	PBBs	1000
Polybrominated Diphenyl Ethers	PBDEs	1000
Dibutyl phthalate	DBP	1000
Benzylbutyl phthalate	BBP	1000
Di-2-ethylhexyl phthalate	DEHP	1000
Diisobutyl phthalate	DIBP	1000

Series Chart

Radial Type

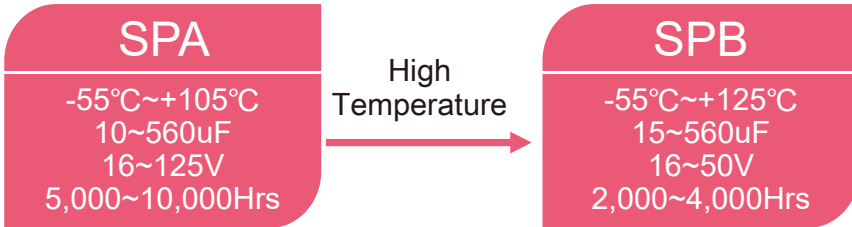

SMD Type

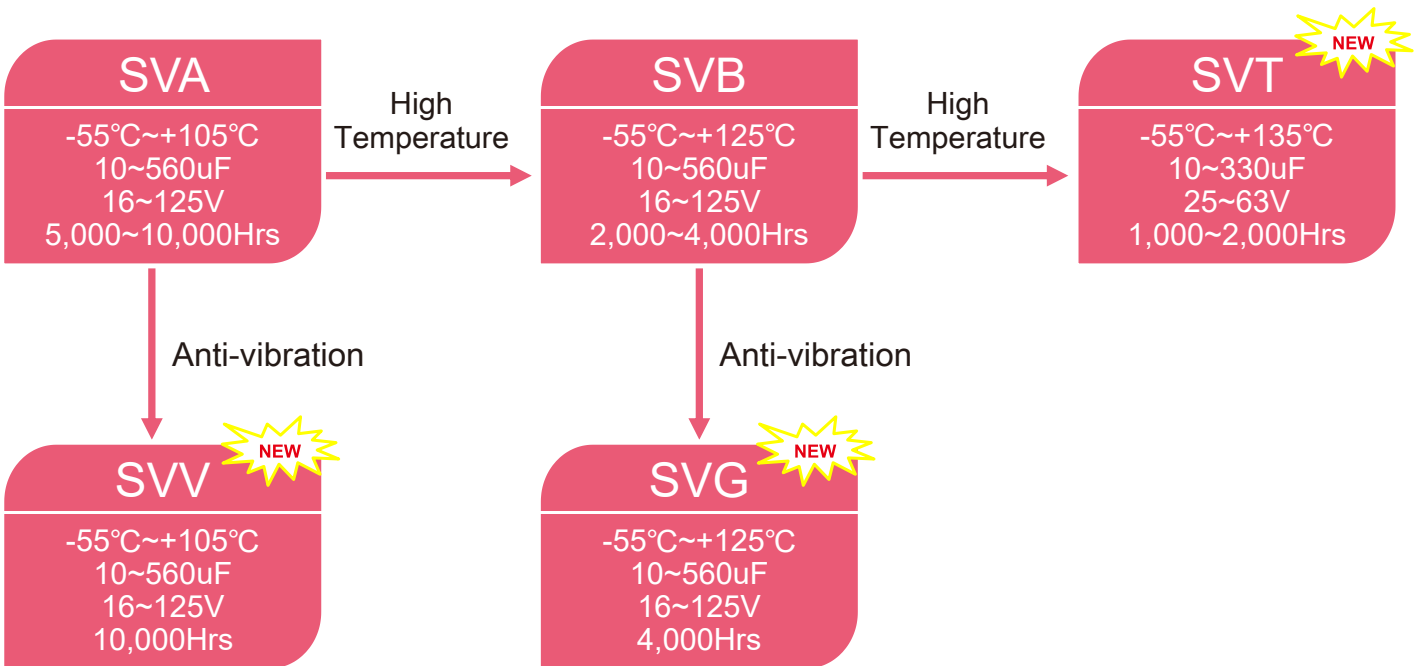

Basic structure

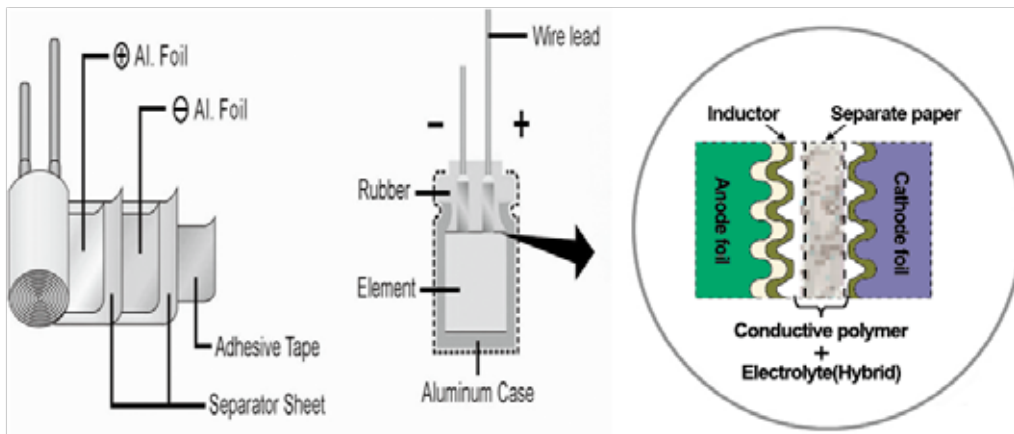

Manufacturing Method

Radial lead type

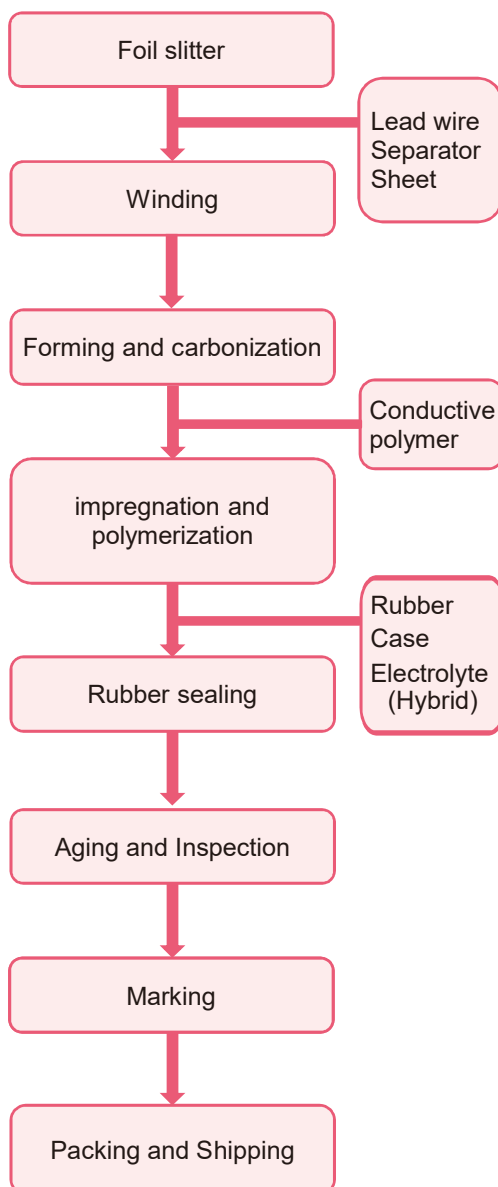

V-CHIP type

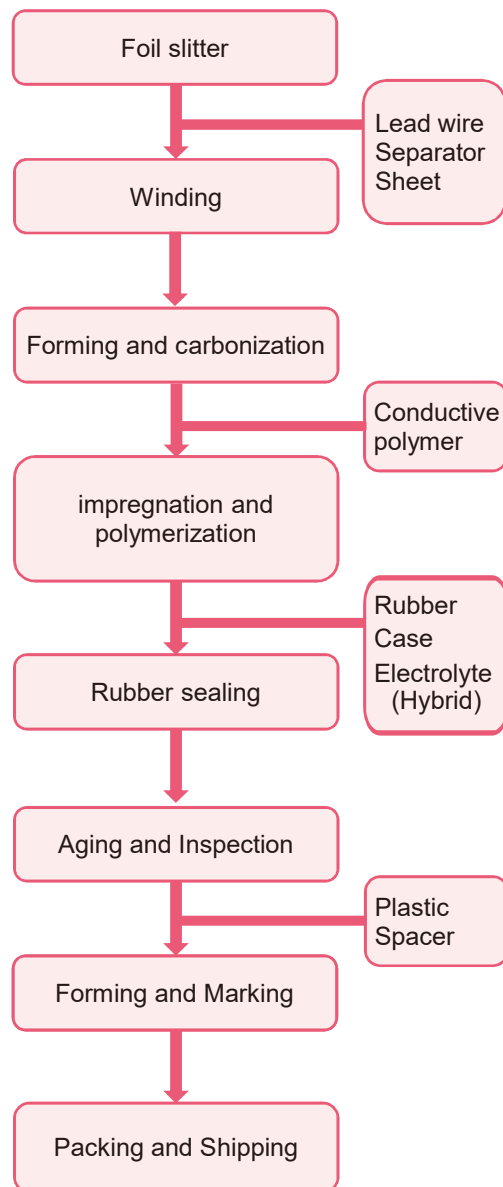

SPA series

SPA

- Low ESR.
- High Voltage, Long Life.
- 105°C, 5,000~10,000hrs.
- RoHS compliant
- For high reliability applications.(Automotive equipment, Base station equipment,etc.)



SPECIFICATIONS

Items	Conditions	Characteristics	
Category Temperature Range	—	-55 to +105°C	
Rated Voltage Range	—	16 ~ 125V	
Capacitance Tolerance	at 20°C, 120Hz	±20%(M)	
Surge Voltage	at 15 ~ 35°C	Rated voltage × 1.15V	
Leakage Current	at 20°C after 2 minutes	$I \leq 0.01CV$ or $3(\mu A)$ Whichever is greater measured,after 2 minutes application of rated working voltage at +20°C. Please see the attached characteristics list	
Dissipation Factor (tan δ)	at 20°C, 120Hz	Please see the attached characteristics list	
Endurance	The following specifications shall be satisfied when the capacitors are restored to 20°C after the rated voltage is applied for 5,000 to 10,000 hours at 105°C. Φ6.3=5,000hrs,D≥Φ8=10,000hrs.	Appearance	NO significant damage.
		Capacitance change	≤ ±30% of the initial value.
		DF (tan δ)	≤ 200% of the initial specified value.
		ESR	≤ 200% of the initial specified value.
		Leakage current	≤ The initial specified value.
Damp Heag (Steady State)	The following specifications shall be satisfied when the capacitors are restored to 20°C after subjecting them to store at 60°C, 90 to 95% RH for 1,000 hours, without DC applied.	Appearance	NO significant damage.
		Capacitance change	≤ ±30% of the initial value.
		DF (tan δ)	≤ 200% of the initial specified value.
		ESR	≤ 200% of the initial specified value.
		Leakage current	≤ The initial specified value.
Surge Voltage	The capacitors shall be subjected to 1,000 cycles each consisting of charge with the surge voltages specified at 15~35°C for 30 seconds through a protective resistor (R = 1 kΩ) and discharge for 5 minutes 30 seconds.	Appearance	NO significant damage.
		Capacitance change	≤ ±30% of the initial value.
		DF (tan δ)	≤ 200% of the initial specified value.
		ESR	≤ 200% of the initial specified value.
		Leakage current	≤ The initial specified value.

※ Note : If any doubt arises, measure the leakage current after following voltage treatment.
Voltage treatmen : DC rated voltage are applied to the capacitors for 120 minutes at 105°C.

MARKING AND DIMENSIONS

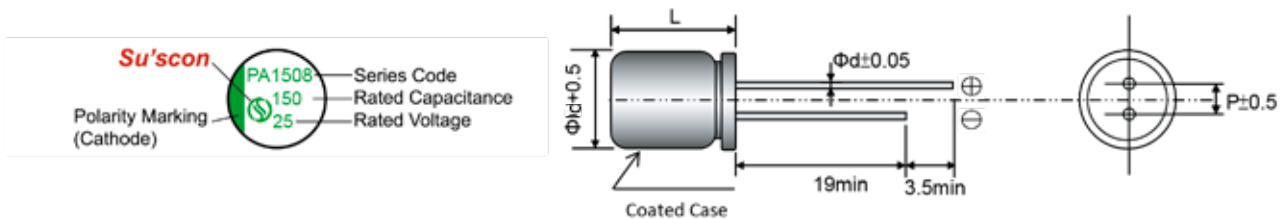

(Unit:mm)

Size Code	6.3x7.2	8x9.5	10x9.5	10x11.5
φ D	6.3	8	10	10
L	L+1.5max	L+1.5max	L+1.5max	L+1.5max
φ d	0.5	0.6	0.6	0.6
P	2.5	3.5	5.0	5.0

SPA

SPA SERIES STANDARD CHARACTERISTICS LIST

Rated voltage (S.V.)	Cap (μF)	Size Code DxL	Leakage current (μA) max.	ESR (mΩ) max. 100k to 300kHz / 20°C	Rated Ripple Current (mA rms) 100kHz / 105°C	D.F. (tanδ) max. 120Hz / 20°C
16 (18.4)	120	6.3x7.2	19	40	1,500	0.16
	270	8x9.5	43	26	2,000	0.16
	470	10x9.5	75	21	2,600	0.16
	560	10x11.5	90	15	3,000	0.16
25 (28.8)	68	6.3x7.2	17	45	1,400	0.16
	150	8x9.5	38	27	1,900	0.16
	270	10x9.5	68	22	2,500	0.16
	330	10x11.5	83	16	2,900	0.16
35 (40.3)	47	6.3x7.2	16	60	1,300	0.16
	100	8x9.5	35	30	1,800	0.16
	150	10x9.5	53	23	2,400	0.16
	220	10x11.5	77	17	2,800	0.16
40 (46.0)	27	6.3x7.2	11	70	1,200	0.16
	56	8x9.5	22	32	1,700	0.16
	100	10x9.5	40	24	2,400	0.16
	120	10x11.5	48	18	2,700	0.16
50 (57.5)	15	6.3x7.2	8	80	1,200	0.16
	33	8x9.5	17	35	1,600	0.16
	56	10x9.5	28	25	2,300	0.16
	82	10x11.5	41	19	2,600	0.16
63 (72.5)	10	6.3x7.2	6	100	1,000	0.16
	22	8x9.5	14	40	1,500	0.16
	33	8x9.5	21	40	1,500	0.16
		10x9.5	21	30	2,100	0.16
	47	10x9.5	30	30	2,100	0.16
80 (92.0)	56	10x11.5	35	22	2,400	0.16
	12	10x9.5	10	70	1,600	0.16
	15	10x9.5	12	70	1,600	0.16
100 (115.0)	18	10x11.5	14	50	1,800	0.16
	10	10x9.5	10	80	1,400	0.16
	12	10x9.5	12	80	1,400	0.16
125 (143.8)	15	10x11.5	15	60	1,600	0.16
	10	10x9.5	13	90	1,200	0.16

Frequency Coefficient of Permissible Ripple Current

Capacitance (μF)	Frequency (Hz)			
	$100 \leq F < 1K$	$1K \leq F < 10K$	$10K \leq F < 100K$	$100K \leq F$
$4.7 < C \leq 33$	0.05	0.32	0.67	1.00
$33 < C$	0.10	0.35	0.70	1.00

SPB series

- Low ESR.
- High Voltage, Long Life.
- 125°C, 2,000~4,000hrs.
- RoHS compliant
- For automotive mouldles and other high temperature applications



SPB

SPECIFICATIONS

Items	Conditions	Characteristics	
Category Temperature Range	—	-55 to +125°C	
Rated Voltage Range	—	16 ~ 50V	
Capacitance Tolerance	at 20°C, 120Hz	±20%(M)	
Surge Voltage	at 15 ~ 35°C	Rated voltage × 1.15V	
Leakage Current	at 20°C after 2 minutes	$I \leq 0.01CV$ or $3(\mu A)$ Whichever is greater measured, after 2 minutes application of rated working voltage at +20°C. Please see the attached characteristics list	
Dissipation Factor ($\tan \delta$)	at 20°C, 120Hz	Please see the attached characteristics list	
Endurance	The following specifications shall be satisfied when the capacitors are restored to 20°C after the rated voltage is applied for 2,000 to 4,000 hours at 125°C. $\Phi 6.3=2,000hrs, D \geq \Phi 8=4,000hrs.$	Appearance	NO significant damage.
		Capacitance change	$\leq \pm 30\%$ of the initial value.
		DF ($\tan \delta$)	$\leq 200\%$ of the initial specified value.
		ESR	$\leq 200\%$ of the initial specified value.
		Leakage current	\leq The initial specified value.
Damp Heag (Steady State)	The following specifications shall be satisfied when the capacitors are restored to 20°C after subjecting them to store at 60°C, 90 to 95% RH for 1,000 hours, without DC applied.	Appearance	NO significant damage.
		Capacitance change	$\leq \pm 30\%$ of the initial value.
		DF ($\tan \delta$)	$\leq 200\%$ of the initial specified value.
		ESR	$\leq 200\%$ of the initial specified value.
		Leakage current	\leq The initial specified value.
Surge Voltage	The capacitors shall be subjected to 1,000 cycles each consisting of charge with the surge voltages specified at 15~35°C for 30 seconds through a protective resistor (R = 1 kΩ) and discharge for 5 minutes 30 seconds.	Appearance	NO significant damage.
		Capacitance change	$\leq \pm 30\%$ of the initial value.
		DF ($\tan \delta$)	$\leq 200\%$ of the initial specified value.
		ESR	$\leq 200\%$ of the initial specified value.
		Leakage current	\leq The initial specified value.

※ Note : If any doubt arises, measure the leakage current after following voltage treatment.
Voltage treatmen : DC rated voltage are applied to the capacitors for 120 minutes at 125°C.

MARKING AND DIMENSIONS

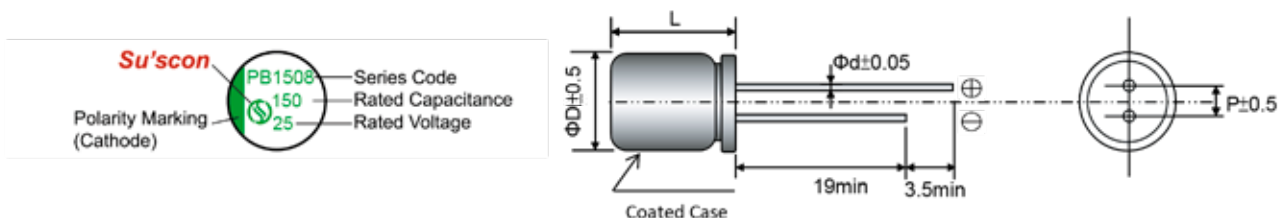

(Unit:mm)

Size Code	6.3x7.2	8x9.5	10x9.5	10x11.5
ϕD	6.3	8.0	10.0	10.0
L	L+1.5max	L+1.5max	L+1.5max	L+1.5max
ϕd	0.5	0.6	0.6	0.6
P	2.5	3.5	5.0	5.0

SPB

SPB SERIES STANDARD CHARACTERISTICS LIST

Rated voltage (S.V.)	Cap (μF)	Size Code DxL	Leakage current (μA) max.	ESR (mΩ) max. 100k to 300kHz / 20°C	Rated Ripple Current (mA rms) 100kHz / 125°C	D.F. (tanδ) max. 120Hz / 20°C
16 (18.4)	120	6.3x7.2	19	40	1,100	0.16
	270	8x9.5	43	26	1,500	0.16
	470	10x9.5	75	21	2,000	0.16
	560	10x11.5	90	15	2,300	0.16
25 (28.8)	68	6.3x7.2	17	45	1,000	0.16
	150	8x9.5	38	27	1,300	0.16
	270	10x9.5	68	22	1,500	0.16
	330	10x11.5	83	16	1,700	0.16
35 (43.3)	47	6.3x7.2	16	60	900	0.16
	100	8x9.5	35	30	1,200	0.16
	150	10x9.5	53	23	1,400	0.16
	220	10x11.5	77	17	1,600	0.16
40 (46.0)	27	6.3x7.2	11	70	900	0.16
	56	8x9.5	22	32	1,200	0.16
	100	10x9.5	40	24	1,400	0.16
	120	10x11.5	48	18	1,600	0.16
50 (57.5)	15	6.3x7.2	8	80	800	0.16
	33	8x9.5	17	35	1,100	0.16
	56	10x9.5	28	25	1,300	0.16
	82	10x11.5	41	19	1,500	0.16

Frequency Coefficient of Permissible Ripple Current

Capacitance (μF)	Frequency (Hz)			
	$100 \leq F < 1K$	$1K \leq F < 10K$	$10K \leq F < 100K$	$100K \leq F$
$4.7 < C \leq 33$	0.05	0.32	0.67	1.00
$33 < C$	0.10	0.35	0.70	1.00

SVA series

- Low ESR.
- High Voltage, Long Life.
- 105°C, 5,000 to 10,000hrs.
- RoHS compliant
- For high reliability applications.(Automotive equipment, Base station equipment,etc.)



SVA

SPECIFICATIONS

Items	Conditions	Characteristics	
Category Temperature Range	—	-55 to +105°C	
Rated Voltage Range	—	16 ~ 125V	
Capacitance Tolerance	at 20°C,120Hz	±20%(M)	
Surge Voltage	at 15 ~ 35°C	Rated voltage ×1.15V	
Leakage Current	at 20°C after 2 minutes	$I \leq 0.01CV$ or $3(\mu A)$ Whichever is greater measured,after 2 minutes application of rated working voltage at +20°C. Please see the attached characteristics list	
Dissipation Factor ($\tan \delta$)	at 20°C,120Hz	Please see the attached characteristics list	
Endurance	The following specifications shall be satisfied when the capacitors are restored to 20°C after the rated voltage is applied for 5,000 to 10,000 hours at 105°C. $\Phi 6.3=5,000hrs, D \geq \Phi 8=10,000hrs.$	Appearance	NO significant damage.
		Capacitance change	$\leq \pm 30\%$ of the initial value.
		DF ($\tan \delta$)	$\leq 200\%$ of the initial specified value.
		ESR	$\leq 200\%$ of the initial specified value.
		Leakage current	\leq The initial specified value.
Damp Heag (Steady State)	The following specifications shall be satisfied when the capacitors are restored to 20°C after subjecting them to store at 60°C, 90 to 95% RH for 1,000 hours, without DC applied.	Appearance	NO significant damage.
		Capacitance change	$\leq \pm 30\%$ of the initial value.
		DF ($\tan \delta$)	$\leq 200\%$ of the initial specified value.
		ESR	$\leq 200\%$ of the initial specified value.
		Leakage current	\leq The initial specified value.
Surge Voltage	The capacitors shall be subjected to 1,000 cycles each consisting of charge with the surge voltages specified at 15~35°C for 30 seconds through a protective resistor (R = 1 kΩ) and discharge for 5 minutes 30 seconds.	Appearance	NO significant damage.
		Capacitance change	$\leq \pm 30\%$ of the initial value.
		DF ($\tan \delta$)	$\leq 200\%$ of the initial specified value.
		ESR	$\leq 200\%$ of the initial specified value.
		Leakage current	\leq The initial specified value.

※ Note : If any doubt arises, measure the leakage current after following voltage treatment.
Voltage treatmen : DC rated voltage are applied to the capacitors for 120 minutes at 105°C.

MARKING AND DIMENSIONS

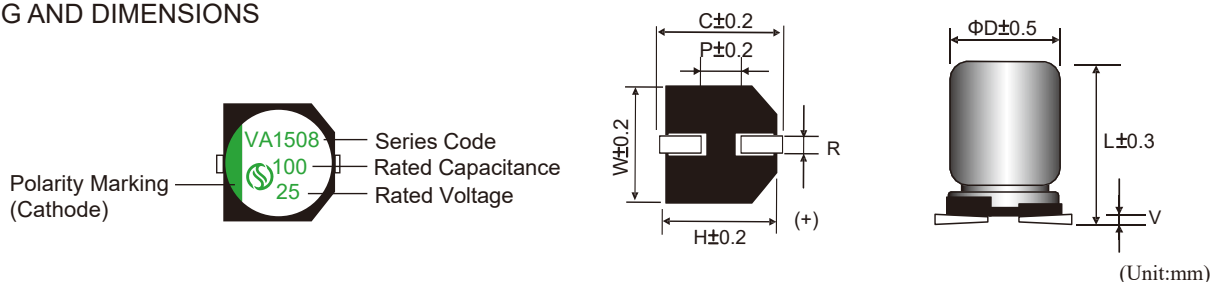

Size	ϕD	L	W	H	C	R	P	V max
6.3×7.7	6.3	7.7	6.6	6.6	7.3	0.5~0.8	2.1	0.3
8×10	8.0	10.5	8.3	8.3	9.0	0.7~1.1	3.2	0.3
10×10	10.0	10.5	10.3	10.3	11.0	0.7~1.3	4.5	0.3
10×12	10.0	12.5	10.3	10.3	11.0	0.7~1.3	4.5	0.3

SVA

SVA SERIES STANDARD CHARACTERISTICS LIST

Rated voltage (S.V.)	Cap (μF)	Size Code DxL	Leakage current (μA) max.	ESR (mΩ) max. 100k to 300kHz / 20°C	Rated Ripple Current (mA rms) 100kHz / 105°C	D.F. (tanδ) max. 120Hz / 20°C
16 (18.4)	120	6.3x7.7	19	40	1,500	0.16
	270	8x10	43	26	2,000	0.16
	470	10x10	75	21	2,600	0.16
	560	10x12	90	15	3,000	0.16
25 (28.8)	68	6.3x7.7	17	45	1,400	0.16
	150	8x10	38	27	1,900	0.16
	270	10x10	68	22	2,500	0.16
	330	10x12	83	16	2,900	0.16
35 (40.3)	47	6.3x7.7	16	60	1,300	0.16
	100	8x10	35	30	1,800	0.16
	150	10x10	53	23	2,400	0.16
	220	10x12	77	17	2,800	0.16
40 (46.0)	27	6.3x7.7	11	70	1,200	0.16
	56	8x10	22	32	1,700	0.16
	100	10x10	40	24	2,400	0.16
	120	10x12	48	18	2,700	0.16
50 (57.5)	15	6.3x7.7	8	80	1,200	0.16
	33	8x10	17	35	1,600	0.16
	56	10x10	28	25	2,300	0.16
	82	10x12	41	19	2,600	0.16
63 (72.5)	10	6.3x7.7	6	100	1,000	0.16
	22	8x10	14	40	1,500	0.16
	33	8x10	21	40	1,500	0.16
		10x10	21	30	2,100	0.16
	47	10x10	30	30	2,100	0.16
80 (92.0)	56	10x12	35	22	2,400	0.16
	12	10x10	10	70	1,600	0.16
	15	10x10	12	70	1,600	0.16
100 (115)	18	10x12	14	50	1,800	0.16
	10	10x10	10	80	1,400	0.16
	12	10x10	12	80	1,400	0.16
125 (143.8)	15	10x12	15	60	1,600	0.16
	10	10x10	13	90	1,200	0.16

Frequency Coefficient of Permissible Ripple Current

Capacitance (μF)	Frequency (Hz)			
	$100 \leq F < 1K$	$1K \leq F < 10K$	$10K \leq F < 100K$	$100K \leq F$
$4.7 < C \leq 33$	0.05	0.32	0.67	1.00
$33 < C$	0.10	0.35	0.70	1.00

SVB series

- Low ESR.
- High Voltage, Long Life.
- 125°C, 2,000 to 4,000hrs.
- RoHS compliant
- For automotive mouldes and other high temperature applications



SVB

SPECIFICATIONS

Items	Conditions	Characteristics	
Category Temperature Range	—	-55 to +125°C	
Rated Voltage Range	—	16 ~ 125V	
Capacitance Tolerance	at 20°C, 120Hz	±20%(M)	
Surge Voltage	at 15 ~ 35°C	Rated voltage × 1.15V	
Leakage Current	at 20°C after 2 minutes	$I \leq 0.01CV$ or $3(\mu A)$ Whichever is greater measured, after 2 minutes application of rated working voltage at +20°C. Please see the attached characteristics list	
Dissipation Factor ($\tan \delta$)	at 20°C, 120Hz	Please see the attached characteristics list	
Endurance	The following specifications shall be satisfied when the capacitors are restored to 20°C after the rated voltage is applied for 2,000 to 4,000 hours at 125°C. $\Phi 6.3=2,000hrs, D \geq \Phi 8=4,000hrs.$	Appearance	NO significant damage.
		Capacitance change	$\leq \pm 30\%$ of the initial value.
		DF ($\tan \delta$)	$\leq 200\%$ of the initial specified value.
		ESR	$\leq 200\%$ of the initial specified value.
		Leakage current	\leq The initial specified value.
Damp Heag (Steady State)	The following specifications shall be satisfied when the capacitors are restored to 20°C after subjecting them to store at 60°C, 90 to 95% RH for 1,000 hours, without DC applied.	Appearance	NO significant damage.
		Capacitance change	$\leq \pm 30\%$ of the initial value.
		DF ($\tan \delta$)	$\leq 200\%$ of the initial specified value.
		ESR	$\leq 200\%$ of the initial specified value.
		Leakage current	\leq The initial specified value.
Surge Voltage	The capacitors shall be subjected to 1,000 cycles each consisting of charge with the surge voltages specified at 15~35°C for 30 seconds through a protective resistor (R = 1 kΩ) and discharge for 5 minutes 30 seconds.	Appearance	NO significant damage.
		Capacitance change	$\leq \pm 30\%$ of the initial value.
		DF ($\tan \delta$)	$\leq 200\%$ of the initial specified value.
		ESR	$\leq 200\%$ of the initial specified value.
		Leakage current	\leq The initial specified value.

※ Note : If any doubt arises, measure the leakage current after following voltage treatment.
Voltage treatmen : DC rated voltage are applied to the capacitors for 120 minutes at 125°C.

MARKING AND DIMENSIONS

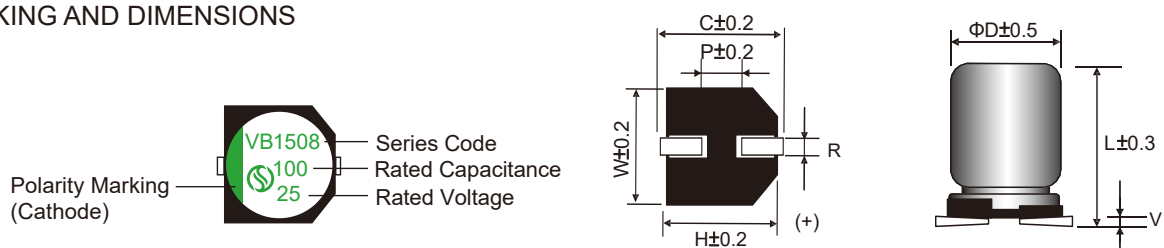

(Unit:mm)

Size	ϕD	L	W	H	C	R	P	V max
6.3×7.7	6.3	7.7	6.6	6.6	7.3	0.5~0.8	2.1	0.3
8×10	8.0	10.5	8.3	8.3	9.0	0.7~1.1	3.2	0.3
10×10	10.0	10.5	10.3	10.3	11.0	0.7~1.3	4.5	0.3
10×12	10.0	12.5	10.3	10.3	11.0	0.7~1.3	4.5	0.3

SVB

SVB SERIES STANDARD CHARACTERISTICS LIST

Rated voltage (S.V.)	Cap (μF)	Size Code DxL	Leakage current (μA) max.	ESR (mΩ) max. 100k to 300kHz / 20°C	Rated Ripple Current (mA rms) 100kHz / 125°C	D.F. (tanδ) max. 120Hz / 20°C
16 (18.8)	120	6.3x7.7	19	40	1,100	0.16
	270	8x10	43	26	1,500	0.16
	470	10x10	75	21	2,000	0.16
	560	10x12	90	15	2,300	0.16
25 (28.8)	68	6.3x7.7	17	45	1,000	0.16
	150	8x10	38	27	1,300	0.16
	270	10x10	68	22	1,500	0.16
	330	10x12	83	16	1,700	0.16
35 (40.3)	47	6.3x7.7	16	60	900	0.16
	100	8x10	35	30	1,200	0.16
	150	10x10	53	23	1,400	0.16
	220	10x12	77	17	1,700	0.16
40 (46)	27	6.3x7.7	11	70	900	0.16
	56	8x10	22	32	1,200	0.16
	100	10x10	40	24	1,400	0.16
	120	10x12	48	18	1,600	0.16
50 (57.5)	15	6.3x7.7	8	80	800	0.16
	33	8x10	17	35	1,100	0.16
	56	10x10	28	25	1,300	0.16
	82	10x12	41	19	1,500	0.16
63 (72.5)	10	6.3x7.7	6	100	700	0.16
	22	8x10	14	40	1,000	0.16
	33	8x10	21	40	1,000	0.16
		10x10	21	30	1,200	0.16
	47	10x10	30	30	1,200	0.16
80 (92.0)	56	10x12	35	22	1,400	0.16
	12	10x10	10	70	900	0.16
	15	10x10	12	70	900	0.16
100 (115)	18	10x12	14	50	1,100	0.16
	10	10x10	10	80	800	0.16
	12	10x10	12	80	800	0.16
125 (143.8)	15	10x12	15	60	1,000	0.16
	10	10x10	13	90	700	0.16

Frequency Coefficient of Permissible Ripple Current

Capacitance (μF)	Frequency (Hz)			
	100 ≤ F < 1K	1K ≤ F < 10K	10K ≤ F < 100K	100K ≤ F
4.7 < C ≤ 33	0.05	0.32	0.67	1.00
33 < C	0.10	0.35	0.70	1.00

SVV series

- Low ESR, Anti-vibration, Peak acceleration: 30G
- High Voltage, Long Life.
- 105°C, 10,000hrs.
- RoHS compliant
- For high reliability applications.(Automotive equipment,Base station equipment,etc.)



SVV

SPECIFICATIONS

Items	Conditions	Characteristics
Category Temperature Range	—	-55 to +105°C
Rated Voltage Range	—	16 ~ 125V
Capacitance Tolerance	at 20°C,120Hz	±20%(M)
Surge Voltage	at 15 ~ 35°C	Rated voltage × 1.15V
Leakage Current	at 20°C after 2 minutes	$I \leq 0.01CV$ or $3(\mu A)$ Whichever is greater measured,after 2 minutes application of rated working voltage at +20°C. Please see the attached characteristics list
Dissipation Factor (tan δ)	at 20°C,120Hz	Please see the attached characteristics list
Endurance	The following specifications shall be satisfied when the capacitors are restored to 20°C after the rated voltage is applied for 10,000 hours at 105°C.	Appearance NO significant damage.
		Capacitance change $\leq \pm 30\%$ of the initial value.
		DF (tan δ) $\leq 200\%$ of the initial specified value.
		ESR $\leq 200\%$ of the initial specified value.
		Leakage current \leq The initial specified value.
Damp Heag (Steady State)	The following specifications shall be satisfied when the capacitors are restored to 20°C after subjecting them to subjecting them to store at 60°C, 90 to 95% RH for 1,000 hours, without DC applied.	Appearance NO significant damage.
		Capacitance change $\leq \pm 30\%$ of the initial value.
		DF (tan δ) $\leq 200\%$ of the initial specified value.
		ESR $\leq 200\%$ of the initial specified value.
		Leakage current \leq The initial specified value.
Surge Voltage	The capacitors shall be subjected to 1,000 cycles each consisting of charge with the surge voltages specified at 15~35°C for 30 seconds through aprotective resistor (R = 1 kΩ) and discharge for 5 minutes 30 seconds.	Appearance NO significant damage.
		Capacitance change $\leq \pm 30\%$ of the initial value.
		DF (tan δ) $\leq 200\%$ of the initial specified value.
		ESR $\leq 200\%$ of the initial specified value.
		Leakage current \leq The initial specified value.

※ Note : If any doubt arises, measure the leakage current after following voltage treatment.
Voltage treatmen : DC rated voltage are applied to the capacitors for 120 minutes at 105°C.

MARKING AND DIMENSIONS

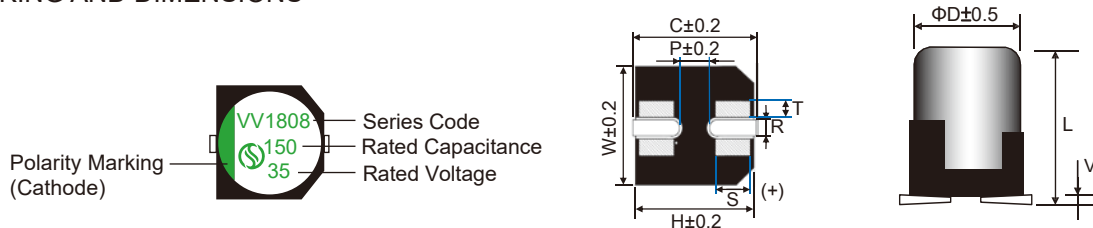

(Unit:mm)

Size	D ^{±0.5}	L ^{±0.5}	W ^{±0.2}	H ^{±0.2}	C ^{±0.2}	R	P ^{±0.2}	S ^{±0.2}	T ^{±0.2}	V ^{max}
10×10	10	10.5	10.3	10.3	11.0	1.0to1.4	4.5	0.7	1.3	0.3
10×12	10	12.5	10.3	10.3	11.0	1.0to1.4	4.5	0.7	1.3	0.3

SVV

SVV SERIES STANDARD CHARACTERISTICS LIST

Rated voltage (S.V.)	Cap (μF)	Size Code DxL	Leakage current (μA) max.	ESR (mΩ) max. 100k to 300kHz / 20°C	Rated Ripple Current (mA rms) 100kHz / 105°C	D.F. (tanδ) max. 120Hz / 20°C
16 (18.4)	470	10×10	75	21	2,600	0.16
	560	10×12	90	15	3,000	0.16
25 (28.8)	270	10×10	68	22	2,500	0.16
	330	10×12	83	16	2,900	0.16
35 (40.3)	150	10×10	53	23	2,400	0.16
	220	10×12	77	17	2,800	0.16
40 (46.0)	100	10×10	40	24	2,400	0.16
	120	10×12	48	18	2,700	0.16
50 (57.5)	56	10×10	28	25	2,300	0.16
	82	10×12	41	19	2,600	0.16
63 (72.5)	33	10×10	21	30	2,100	0.16
	47	10×10	30	30	2,100	0.16
	56	10×12	35	22	2,400	0.16
80 (92.0)	12	10×10	10	70	1,600	0.16
	15	10×10	12	70	1,600	0.16
	18	10×12	14	50	1,800	0.16
100 (115.0)	10	10×10	10	80	1,400	0.16
	12	10×10	12	80	1,400	0.16
	15	10×12	15	60	1,600	0.16
125 (143.8)	10	10×10	13	90	1,200	0.16

Frequency Coefficient of Permissible Ripple Current

Capacitance (μF)	Frequency (Hz)			
	100 ≦ F < 1K	1K ≦ F < 10K	10K ≦ F < 100K	100K ≦ F
4.7 < C ≦ 33	0.05	0.32	0.67	1.00
33 < C	0.10	0.35	0.70	1.00

SVG series

- Low ESR, Anti-vibration, Peak acceleration: 30G
- High Voltage, Long Life.
- 125°C, 4,000hrs.
- RoHS compliant
- For automotive mouldes and other high temperature applications



SVG

SPECIFICATIONS

Items	Conditions	Characteristics
Category Temperature Range	—	-55 to +125°C
Rated Voltage Range	—	16 ~ 125V
Capacitance Tolerance	at 20°C,120Hz	±20%(M)
Surge Voltage	at 15 ~ 35°C	Rated voltage × 1.15V
Leakage Current	at 20°C after 2 minutes	$I \leq 0.01CV$ or $3(\mu A)$ Whichever is greater measured,after 2 minutes application of rated working voltage at +20°C. Please see the attached characteristics list
Dissipation Factor (tan δ)	at 20°C,120Hz	Please see the attached characteristics list
Endurance	The following specifications shall be satisfied when the capacitors are restored to 20°C after the rated voltage is applied for 4,000 hours at 125°C.	Appearance NO significant damage.
		Capacitance change $\leq \pm 30\%$ of the initial value.
		DF (tan δ) $\leq 200\%$ of the initial specified value.
		ESR $\leq 200\%$ of the initial specified value.
		Leakage current \leq The initial specified value.
Damp Heag (Steady State)	The following specifications shall be satisfied when the capacitors are restored to 20°C after subjecting them to subjecting them to store at 60°C, 90 to 95% RH for 1,000 hours, without DC applied.	Appearance NO significant damage.
		Capacitance change $\leq \pm 30\%$ of the initial value.
		DF (tan δ) $\leq 200\%$ of the initial specified value.
		ESR $\leq 200\%$ of the initial specified value.
		Leakage current \leq The initial specified value.
Surge Voltage	The capacitors shall be subjected to 1,000 cycles each consisting of charge with the surge voltages specified at 15~35°C for 30 seconds through aprotective resistor (R = 1 kΩ) and discharge for 5 minutes 30 seconds.	Appearance NO significant damage.
		Capacitance change $\leq \pm 30\%$ of the initial value.
		DF (tan δ) $\leq 200\%$ of the initial specified value.
		ESR $\leq 200\%$ of the initial specified value.
		Leakage current \leq The initial specified value.

※ Note : If any doubt arises, measure the leakage current after following voltage treatment.
Voltage treatmen : DC rated voltage are applied to the capacitors for 120 minutes at 125°C.

MARKING AND DIMENSIONS

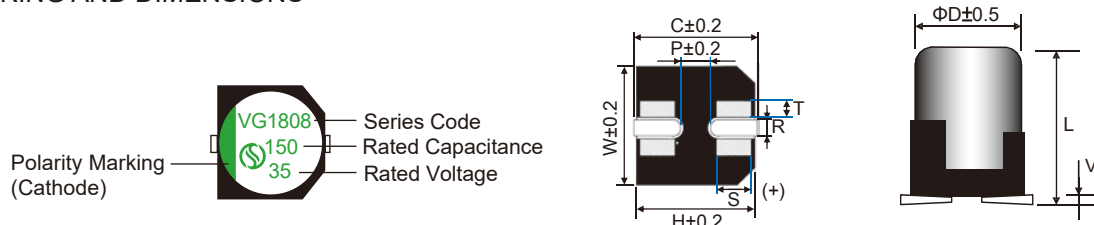

(Unit:mm)

Size	D ^{±0.5}	L ^{±0.5}	W ^{±0.2}	H ^{±0.2}	C ^{±0.2}	R	P ^{±0.2}	S ^{±0.2}	T ^{±0.2}	V ^{max}
10×10	10	10.5	10.3	10.3	11.0	1.0to1.4	4.5	0.7	1.3	0.3
10×12	10	12.5	10.3	10.3	11.0	1.0to1.4	4.5	0.7	1.3	0.3

SVG

SVG SERIES STANDARD CHARACTERISTICS LIST

Rated voltage (S.V.)	Cap (μF)	Size Code DxL	Leakage current (μA) max.	ESR (mΩ) max. 100k to 300kHz / 20°C	Rated Ripple Current (mA rms) 100kHz / 125°C	D.F. (tanδ) max. 120Hz / 20°C
16 (18.4)	470	10x10	75	21	2,000	0.16
	560	10x12	90	15	2,300	0.16
25 (28.8)	270	10x10	68	22	1,500	0.16
	330	10x12	83	16	1,700	0.16
35 (40.3)	150	10x10	53	23	1,400	0.16
	220	10x12	77	17	1,700	0.16
40 (46.0)	100	10x10	40	24	1,400	0.16
	120	10x12	48	18	1,600	0.16
50 (57.5)	56	10x10	28	25	1,300	0.16
	82	10x12	41	19	1,500	0.16
63 (72.5)	33	10x10	21	30	1,200	0.16
	47	10x10	30	30	1,200	0.16
	56	10x12	35	22	1,400	0.16
80 (92.0)	12	10x10	10	70	900	0.16
	15	10x10	12	70	900	0.16
	18	10x12	14	50	1,100	0.16
100 (115.0)	10	8x10	10	80	800	0.16
	12	10x10	12	80	800	0.16
	15	10x12	15	60	1,000	0.16
125 (143.8)	10	10x10	13	90	700	0.16

Frequency Coefficient of Permissible Ripple Current

Capacitance (μF)	Frequency (Hz)			
	100 ≦ F < 1K	1K ≦ F < 10K	10K ≦ F < 100K	100K ≦ F
4.7 < C ≦ 33	0.05	0.32	0.67	1.00
33 < C	0.10	0.35	0.70	1.00

SVT series

- Low ESR.High Temperature
- High Voltage, Long Life.
- 135°C, ,1,000 to 2,000hrs..
- RoHS compliant
- For automotive mouldles and other high temperature applications



SVT

SPECIFICATIONS

Items	Conditions	Characteristics
Category Temperature Range	—	-55 to +135°C
Rated Voltage Range	—	25 ~ 63V
Capacitance Tolerance	at 20°C,120Hz	±20%(M)
Surge Voltage	at 15 ~ 35°C	Rated voltage × 1.15V
Leakage Current	at 20°C after 2 minutes	$I \leq 0.01CV$ or $3(\mu A)$ Whichever is greater measured,after 2 minutes application of rated working voltage at +20°C. Please see the attached characteristics list
Dissipation Factor (tan δ)	at 20°C,120Hz	Please see the attached characteristics list
Endurance	The following specifications shall be satisfied when the capacitors are restored to 20°C after the rated voltage is applied for 1,000 to 2,000 hours at 135°C. Φ6.3=1,000hrs,D≥Φ8=2,000hrs.	Appearance NO significant damage.
		Capacitance change $\leq \pm 30\%$ of the initial value.
		DF (tan δ) $\leq 200\%$ of the initial specified value.
		ESR $\leq 200\%$ of the initial specified value.
		Leakage current \leq The initial specified value.
Damp Heag (Steady State)	The following specifications shall be satisfied when the capacitors are restored to 20°C after subjecting them to subjecting them to store at 60°C, 90 to 95% RH for 1,000 hours, without DC applied.	Appearance NO significant damage.
		Capacitance change $\leq \pm 30\%$ of the initial value.
		DF (tan δ) $\leq 200\%$ of the initial specified value.
		ESR $\leq 200\%$ of the initial specified value.
		Leakage current \leq The initial specified value.
Surge Voltage	The capacitors shall be subjected to 1,000 cycles each consisting of charge with the surge voltages specified at 15~35°C for 30 seconds through aprotective resistor (R = 1 kΩ) and discharge for 5 minutes 30 seconds.	Appearance NO significant damage.
		Capacitance change $\leq \pm 30\%$ of the initial value.
		DF (tan δ) $\leq 200\%$ of the initial specified value.
		ESR $\leq 200\%$ of the initial specified value.
		Leakage current \leq The initial specified value.

※ Note : If any doubt arises, measure the leakage current after following voltage treatment.
Voltage treatmen : DC rated voltage are applied to the capacitors for 120 minutes at 135°C.

MARKING AND DIMENSIONS

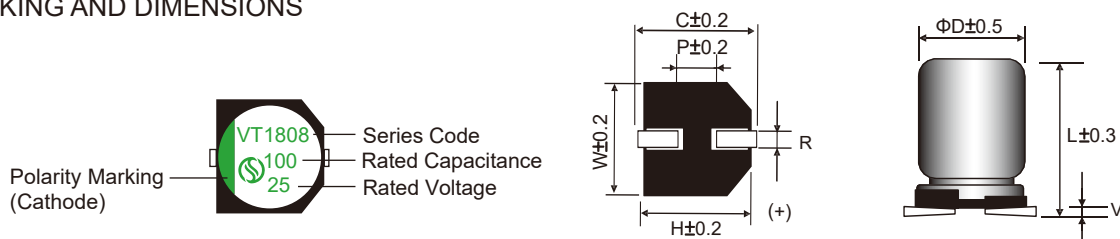

(Unit:mm)

Size	φ D	L	W	H	C	R	P	V max
6.3×7.7	6.3	7.7	6.6	6.6	7.3	0.5~0.8	2.1	0.3
8×10	8.0	10.5	8.3	8.3	9.0	0.7~1.1	3.2	0.3
10×10	10.0	10.5	10.3	10.3	11.0	0.7~1.3	4.5	0.3
10×12	10.0	12.5	10.3	10.3	11.0	0.7~1.3	4.5	0.3

SVT

SVT SERIES STANDARD CHARACTERISTICS LIST

Rated voltage (S.V.)	Cap (μF)	Size Code DxL	Leakage current (μA) max.	ESR (mΩ) max. 100k to 300kHz / 20°C	Rated Ripple Current (mA rms) 100kHz / 135°C	D.F. (tanδ) max. 120Hz / 20°C
25 (28.8)	68	6.3×7.7	17	45	750	0.16
	150	8x10	38	27	1,000	0.16
	270	10x10	68	22	1,200	0.16
	330	10x12	83	16	1,350	0.16
35 (40.3)	47	6.3×7.7	16	60	730	0.16
	100	8x10	35	30	1,000	0.16
	150	10x10	53	23	1,100	0.16
	220	10x12	77	17	1,300	0.16
40 (46)	27	6.3×7.7	11	70	700	0.16
	56	8x10	22	32	950	0.16
	100	10x10	40	24	1,100	0.16
	120	10x12	48	18	1,300	0.16
50 (57.5)	15	6.3×7.7	8	80	650	0.16
	33	8x10	17	35	900	0.16
	56	10x10	28	25	1,100	0.16
	82	10x12	41	19	1,250	0.16
63 (72.5)	10	6.3×7.7	6	100	550	0.16
	22	8x10	14	40	850	0.16
	33	8x10	21	40	850	0.16
		10x10	21	30	1,000	0.16
	47	10x10	30	30	1,000	0.16
	56	10x12	35	22	1,100	0.16

Frequency Coefficient of Permissible Ripple Current

Capacitance (μF)	Frequency (Hz)			
	100 ≦ F < 1K	1K ≦ F < 10K	10K ≦ F < 100K	100K ≦ F
4.7 < C ≦ 33	0.05	0.32	0.67	1.00
33 < C	0.10	0.35	0.70	1.00

Series Chart

Radial Type

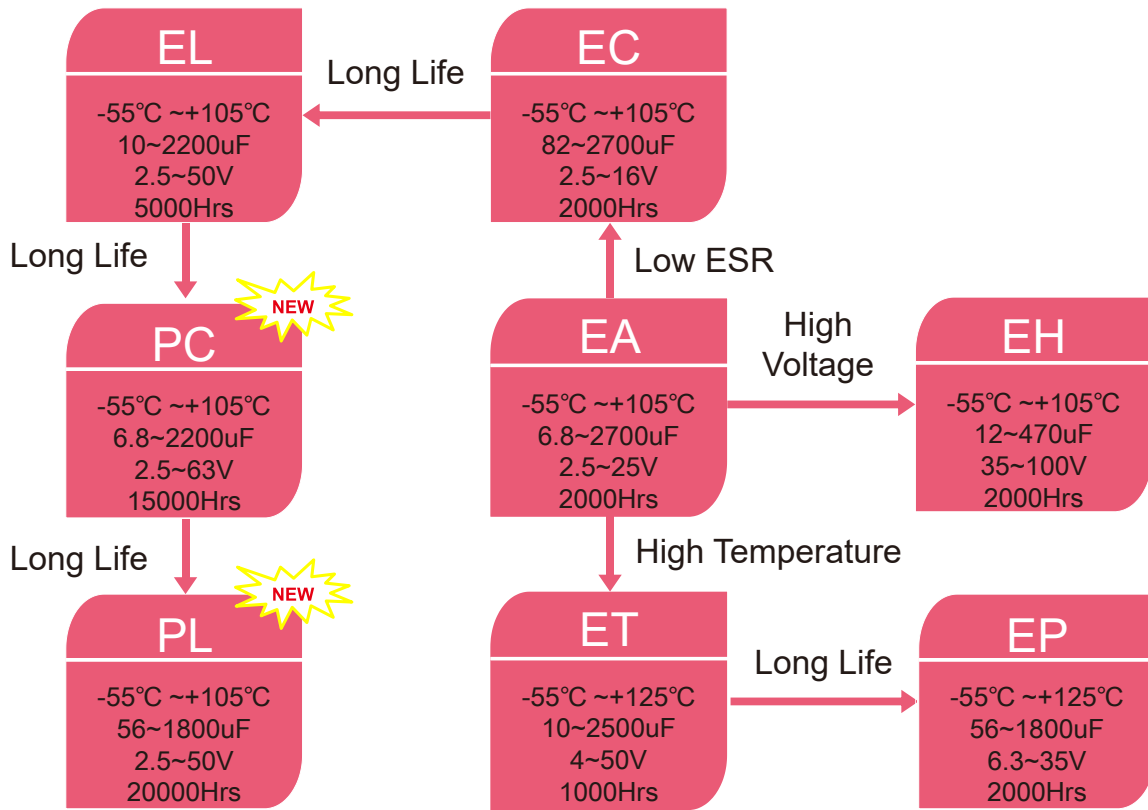

SMD Type

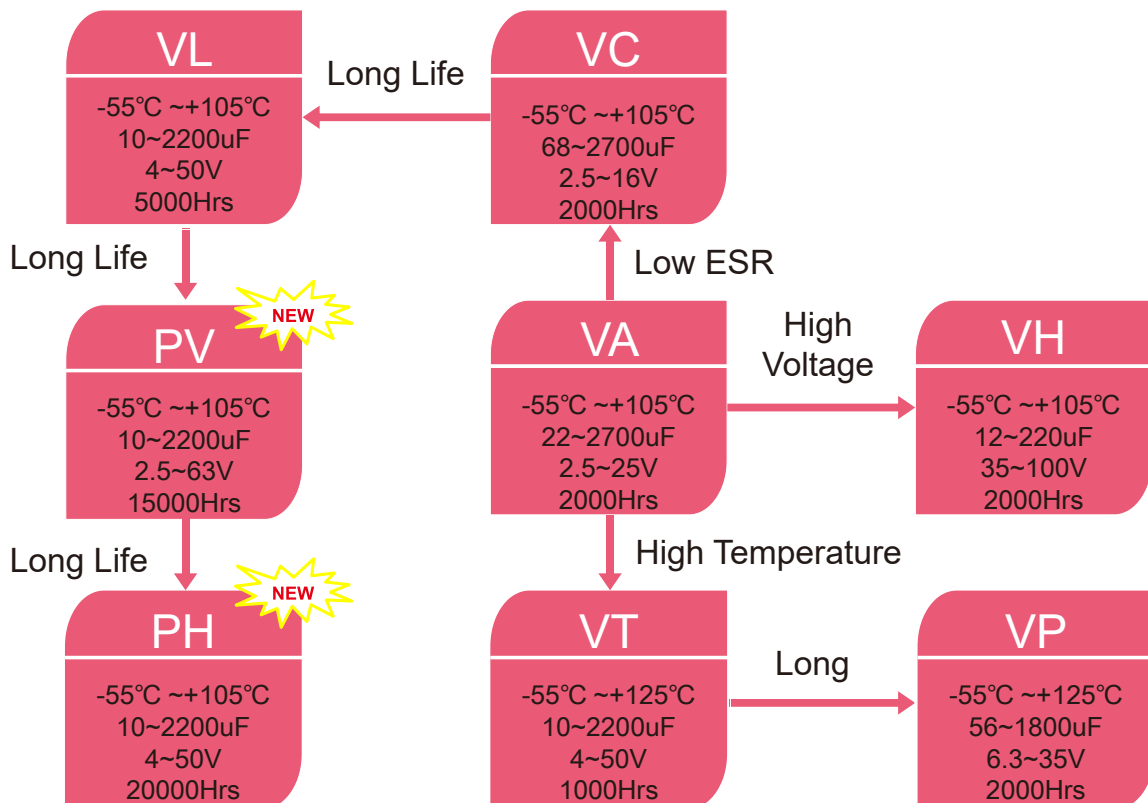

Basic structure

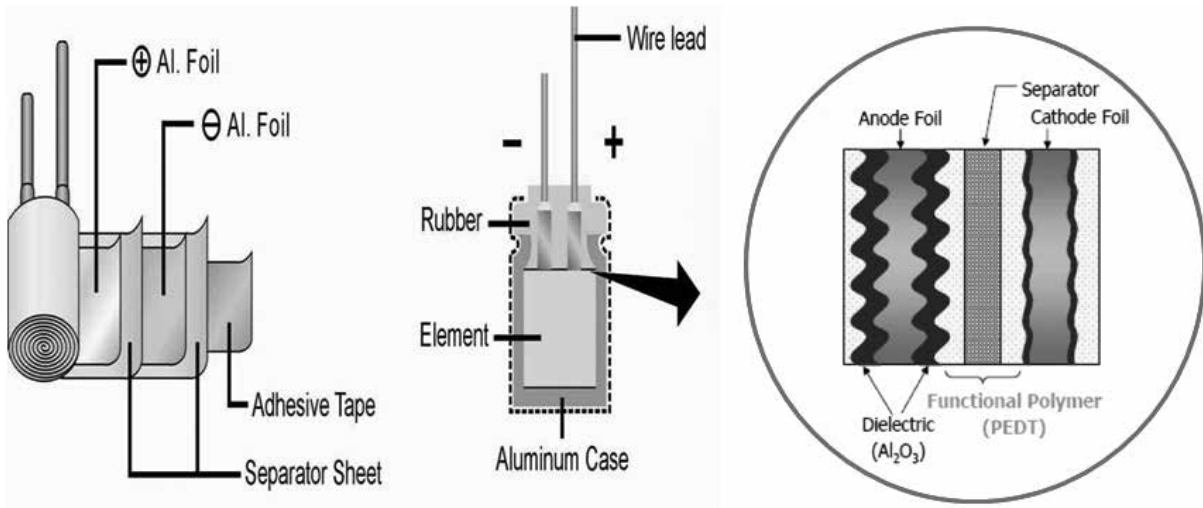

Manufacturing Method

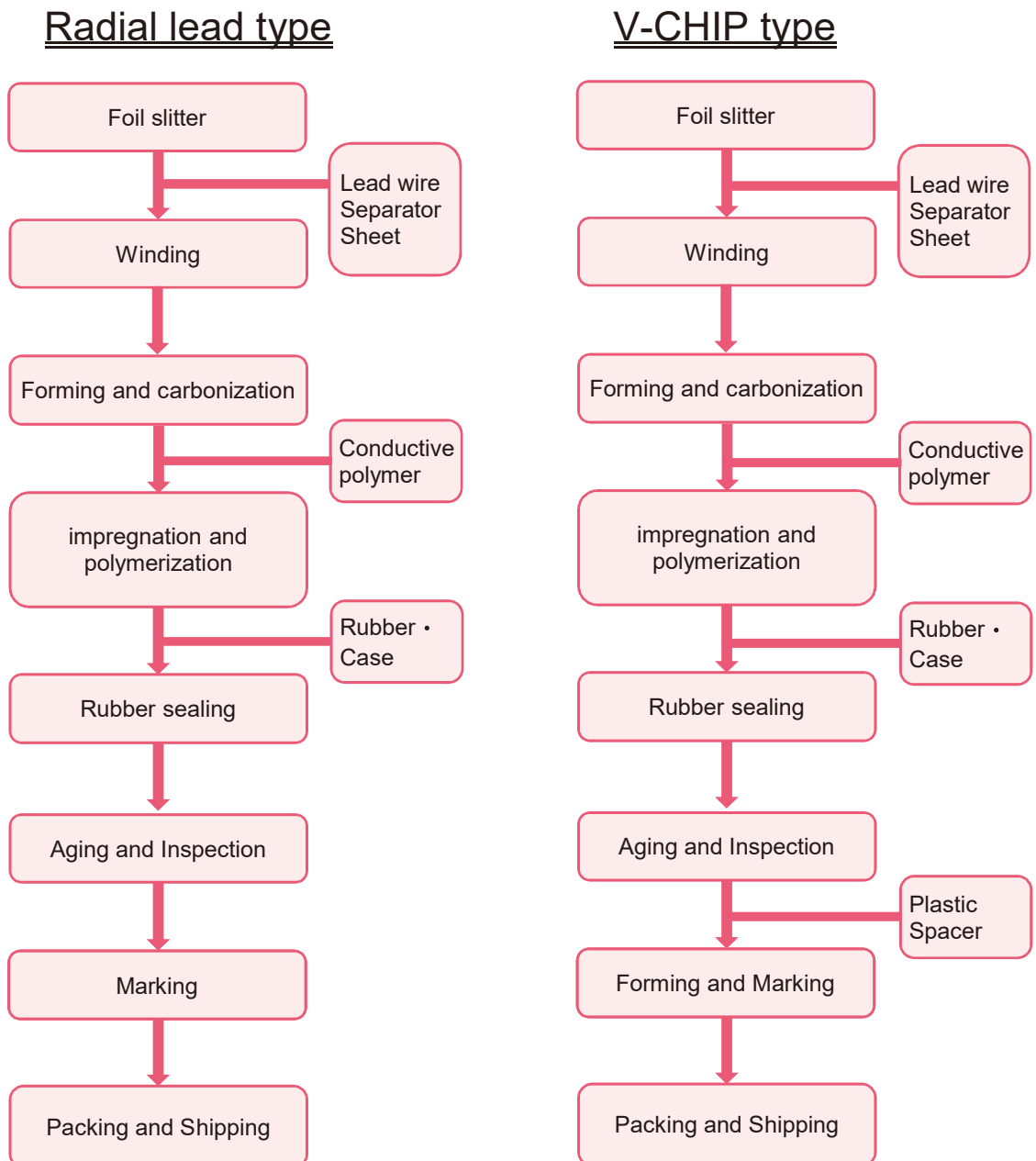

EA series

- Standard radial lead type.
- Rated voltage : 2.5~25V.
- Endurance : 2,000hours at 105°C
- Applications : motherboards, servers, VGA, etc.
- RoHS Compliance.
- Halogen Free compliant



SPECIFICATIONS

Items	Conditions	Characteristics
Category Temperature Range	—	-55 to +105°C
Rated Voltage Range	—	2.5 ~ 25V
Capacitance Tolerance	at 20°C, 120 Hz	±20% (M)
Surge Voltage	at 105°C	Rated voltage ×1.15V
Leakage Current	at 20°C after 2 minutes	$I \leq 0.2CV$ or $300(\mu A)$ Whichever is greater measured,after 2minutes application of rated working voltage at +20°C. Please see the attached characteristics list
Dissipation Factor (tan δ)	at 20°C, 120 Hz	Please see the attached characteristics list
Characteristics of Impedance at low, high temperature	at -55°C,100kHz	$Z(-55^{\circ}C) / Z(+20^{\circ}C) \leq 1.25$
	at -25°C,100kHz	$Z(-25^{\circ}C) / Z(+20^{\circ}C) \leq 1.15$
Endurance	The following specifications shall be satisfied when the capacitors are restored to 20°C after the rated voltage is applied for 2,000 hours at 105°C.	Appearance NO significant damage.
		Capacitance change $\leq \pm 20\%$ of the initial value.
		DF (tan δ) $\leq 150\%$ of the initial specified value.
		ESR $\leq 150\%$ of the initial specified value.
		Leakage current \leq The initial specified value.
Damp Heag (Steady State)	The following specifications shall be satisfied when the capacitors are restored to 20°C after subjecting them to store 60°C, 90 to 95% RH for 1,000 hours, without DC applied.	Appearance NO significant damage.
		Capacitance change $\leq \pm 20\%$ of the initial value.
		DF (tan δ) $\leq 150\%$ of the initial specified value.
		ESR $\leq 150\%$ of the initial specified value.
		Leakage current \leq The initial specified value.
Surge Voltage	The capacitors shall be subjected to 1,000 cycles each consisting of charge with the surge voltages specified at 105°C for 30 seconds through aprotective resistor (R = 1 kΩ) and discharge for 5 minutes 30 seconds.	Appearance NO significant damage.
		Capacitance change $\leq \pm 20\%$ of the initial value.
		DF (tan δ) $\leq 150\%$ of the initial specified value.
		ESR $\leq 150\%$ of the initial specified value.
		Leakage current \leq The initial specified value.

※ Note : If any doubt arises, measure the leakage current after following voltage treatment.
Voltage treatment : DC rated voltage are applied to the capacitors for 120 minutes at 105°C.

MARKING AND DIMENSIONS

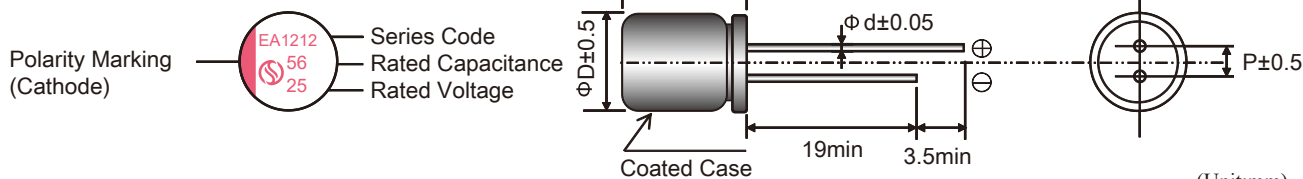

(Unit:mm)

Size	5x6	5x8	6.3x6	6.3x8	6.3x11	8x8	8x12	10x12、14
ϕD	5	5	6.3	6.3	6.3	8	8	10
L	L+1.0 max	L+1.0 max	L+1.0 max	L+1.5 max	L+1.0 max	L+1.0 max	L+1.0 max	L+1.0 max
ϕd	0.45	0.5	0.45	0.5	0.5	0.6	0.6	0.6
P	2	2	2.5	2.5	2.5	3.5	3.5	5.0

EA SERIES STANDARD CHARACTERISTICS LIST

Rated Voltage (S.V.)	Cap (μF)	Size DxL	Leakage current (μA) max. ※2	ESR (mΩ) max. 100k to 300kHz / 20°C	Rated Ripple Current (mA rms) 100kHz / 105°C	D.F. (tanδ) max. 120Hz / 20°C
2.5 (2.9)	390	6.3×6	300	35	2,100	0.12
	560	6.3×8	300	12	3,500	0.12
	560	8×8	300	12	4,320	0.12
	820	6.3×8	410	12	5,200	0.12
	1,200	8×8	600	12	5,200	0.12
	1,500	8×12	750	10	5,200	0.12
	2,700	10×12	1,350	10	5,230	0.12
4 (4.6)	270	6.3×6	300	35	2,000	0.12
	560	6.3×8	448	15	3,500	0.12
	680	6.3×8	544	15	3,500	0.12
	820	8×8	656	13	5,100	0.12
	1,000	8×12	800	12	5,100	0.12
	2,200	10×12	1,760	12	5,560	0.12
6.3 (7.2)	82	5×6	300	40	1,700	0.12
	100	6.3×6	300	35	1,900	0.12
	220	6.3×6	300	35	1,900	0.12
	470	6.3×8	592	15	3,630	0.12
	560	6.3×8	706	15	3,630	0.12
	560	8×8	706	15	4,210	0.12
	680	8×8	857	15	4,710	0.12
	1,000	8×12	1,260	14	5,100	0.12
	1,500	10×10	1,890	15	5,400	0.12
	2,200	10×12	2,772	15	5,400	0.12
10 (11.5)	47	5×8	300	25	2,200	0.12
	220	5×8	440	25	2,200	0.12
	330	6.3×8	660	25	3,560	0.12
	680	8×8	1,360	25	3,700	0.12
	820	8×12	1,640	12	4,500	0.12
	1,500	10×12	3,000	12	5,440	0.12
16 (18.4)	47	6.3×6	300	25	1,620	0.12
	82	6.3×6	300	25	1,890	0.12
	100	6.3×6	320	25	1,890	0.12
	270	6.3×8	864	15	2,680	0.12
	470	8×8	1,504	15	2,820	0.12
	560	8×12	1,792	20	3,640	0.12
	680	10×12	2,176	16	4,270	0.12
	820	10×12	2,624	16	4,270	0.12
1,000	10×12	3,200	16	4,270	0.12	

※ 1. Capacitance tolerance : ±20% (M)
 ※ 2. After 2 minutes

EA

EA SERIES STANDARD CHARACTERISTICS LIST

Rated Voltage (S.V.)	Cap (μF)	Size DxL	Leakage current (μA) max. ※2	ESR (mΩ) max. 100k to 300kHz / 20°C	Rated Ripple Current (mA rms) 100kHz / 105°C	D.F. (tanδ) max. 120Hz / 20°C
20 (23.0)	22	6.3×6	300	60	1,450	0.12
	82	6.3×6	328	60	1,450	0.12
	220	6.3×8	880	40	1,620	0.12
	330	8×8	1,320	40	2,400	0.12
	470	8×12	1,880	24	3,320	0.12
	820	10×12	3,280	20	3,800	0.12
25 (28.8)	6.8	6.3×6	300	80	1,200	0.12
	47	6.3×6	300	40	2,000	0.12
	100	6.3×8	500	30	2,150	0.12
	180	8×8	900	30	2,580	0.12
	220	8×12	1,100	25	3,200	0.12
	330	10×10	1,650	28	3,800	0.12
	470	10×12	2,350	25	4,100	0.12
	560	10×14	2,800	20	4,500	0.12
	680	8×16	3,400	20	4,600	0.12
	820	10×14	4,100	20	5,000	0.12

※ 1. Capacitance tolerance : ±20% (M)
 ※ 2. After 2 minutes

FREQUENCY COEFFICIENT FOR RIPPLE CURRENT

Frequency	120Hz ≤ f < 1kHz	1kHz ≤ f < 10kHz	10kHz ≤ f < 100kHz	100kHz ≤ f < 500kHz
Coefficient	0.05	0.3	0.7	1

EA

EC series

- Low ESR at high frequency range.
- Rated voltage : 2.5~16V
- Endurance : 2,000 hours at 105°C
- Applications : LCD Monitor, LCD-TV, D/A Inverter, SPS, D/D Converter, etc.
- RoHS Compliance.
- Halogen Free compliant



EC

SPECIFICATIONS

Items	Conditions	Characteristics
Category Temperature Range	—	-55 to +105°C
Rated Voltage Range	—	2.5 ~ 16V
Capacitance Tolerance	at 20°C, 120 Hz	±20% (M)
Surge Voltage	at 105°C	Rated voltage x 1.15v
Leakage Current	at 20°C after 2 minutes	$I \leq 0.2CV$ or $300(\mu A)$ Whichever is greater measured,after 2minutes application of rated working voltage at +20°C. Please see the attached characteristics list
Dissipation Factor (tan δ)	at 20°C, 120 Hz	Please see the attached characteristics list
Characteristics of Impedance at low, high temperature	at -55°C,100kHz	$Z(-55^{\circ}C) / Z(+20^{\circ}C) \leq 1.25$
	at -25°C,100kHz	$Z(-25^{\circ}C) / Z(+20^{\circ}C) \leq 1.15$
Endurance	The following specifications shall be satisfied when the capacitors are restored to 20°C after the rated voltage is applied for 2,000 hours at 105°C.	Appearance NO significant damage.
		Capacitance change $\leq \pm 20\%$ of the initial value.
		DF (tan δ) $\leq 150\%$ of the initial specified value.
		ESR $\leq 150\%$ of the initial specified value.
Damp Heag (Steady State)	The following specifications shall be satisfied when the capacitors are restored to 20°C after subjecting them to store 60°C, 90 to 95% RH for 1,000 hours, without DC applied.	Appearance NO significant damage.
		Capacitance change $\leq \pm 20\%$ of the initial value.
		DF (tan δ) $\leq 150\%$ of the initial specified value.
		ESR $\leq 150\%$ of the initial specified value.
Surge Voltage	The capacitors shall be subjected to 1,000 cycles each consisting of charge with the surge voltages specified at 105°C for 30 seconds through a protective resistor (R = 1kΩ) and discharge for 5 minutes 30 seconds.	Appearance NO significant damage.
		Capacitance change $\leq \pm 20\%$ of the initial value.
		DF (tan δ) $\leq 150\%$ of the initial specified value.
		ESR $\leq 150\%$ of the initial specified value.
		Leakage current \leq The initial specified value.

※ Note : If any doubt arises, measure the leakage current after following voltage treatment.
Voltage treatment : DC rated voltage are applied to the capacitors for 120 minutes at 105°C.

MARKING AND DIMENSIONS

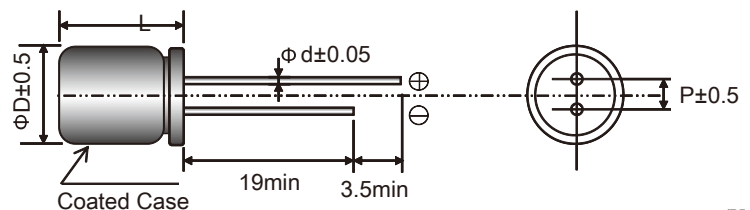

(Unit:mm)

Size	5x6 - 8	6.3x6	6.3x8	6.3x11	8x8	8x12	8x16	8x20	10x12	10x16 - 20
φD	5	6.3	6.3	6.3	8	8	8	8	10	10
L	L+1.0 max	L+1.0 max	L+1.5 max	L+1.0 max	L+1.5 max	L+1.0 max	L+1.0 max	L+1.5 max	L+1.0 max	L+1.5 max
φd	0.45	0.45	0.5	0.5	0.6	0.6	0.6	0.6	0.6	0.6
P	2	2.5	2.5	2.5	3.5	3.5	3.5	3.5	5.0	5.0

EC SERIES STANDARD CHARACTERISITICS LIST

Rated Voltage (S.V.)	Cap (μF)	Size DxL	Leakage current (μA) max. ※2	ESR (mΩ) max. 100k to 300kHz / 20°C	Rated Ripple Current (mA rms) 100kHz / 105°C	D.F. (tanδ) max. 120Hz / 20°C
2.5 (2.9)	560	6.3×8	300	8	5,080	0.12
	560	8×8	300	7	5,820	0.12
	820	6.3×8	410	8	5,080	0.12
	1,200	8×8	600	7	5,580	0.12
	1,500	8×12	750	7	5,820	0.12
	2,700	10×12	1,350	7	6,100	0.12
4 (4.6)	560	6.3×8	448	8	5,080	0.12
	560	8×8	448	7	5,580	0.12
	680	8×8	544	7	5,580	0.12
	820	8×12	656	7	5,820	0.12
	2200	10×12	1,760	7	6,100	0.12
6.3 (7.2)	100	5×6	300	13	1,500	0.12
	270	5×8	340	12	2,400	0.12
	470	6.3×8	592	10	4,500	0.12
	560	6.3×8	706	10	5,080	0.12
	560	8×8	706	10	5,580	0.12
	1,000	8×12	1,260	7	5,820	0.12
	1,000	10×12	1,260	7	6,200	0.12
	2,200	10×12	2,772	7	6,200	0.12
10 (11.5)	220	6.3×8	440	10	2,820	0.12
	270	6.3×8	540	10	3,580	0.12
	560	8×8	1,120	8	5,580	0.12
	680	8×8	1,360	9	5,580	0.12
	820	8×12	1,640	9	5,820	0.12
	1,000	10×12	2,000	9	6,100	0.12
	1,500	10×12	3,000	9	6,100	0.12

※ 1. Capacitance tolerance : ±20% (M)
 ※ 2. After 2 minutes



EC SERIES STANDARD CHARACTERISTICS LIST

Rated Voltage (S.V.)	Cap (μF)	Size DxL	Leakage current (μA) max. ※2	ESR (mΩ) max. 100k to 300kHz / 20°C	Rated Ripple Current (mA rms) 100kHz / 105°C	D.F. (tanδ) max. 120Hz / 20°C
16 (18.4)	82	6.3×6	300	30	2,200	0.12
	100	6.3×6	320	30	2,200	0.12
	220	6.3×8	704	15	3,500	0.12
	270	6.3×8	864	15	3,500	0.12
	330	6.3×11	1,056	15	3,500	0.12
	470	8×8	1,504	13	4,500	0.12
	470	8×12	1,504	13	5,400	0.12
	470	10×12	1,504	13	6,100	0.12
	560	8×12	1,792	16	5,400	0.12
	680	10×12	2,176	16	6,100	0.12
	820	10×12	2,624	10	6,100	0.12
	1000	8×16	3,200	10	6,100	0.10
	1000	10×12	3,200	10	6,100	0.10
	1500	8×20	4,800	8	6,100	0.10
	1500	10×16	4,800	8	6,500	0.10
	1800	10×20	5,760	8	6,800	0.10
2200	10×20	7,040	8	6,800	0.10	

※ 1. Capacitance tolerance : ±20% (M)

※ 2. After 2 minutes

FREQUENCY COEFFICIENT FOR RIPPLE CURRENT

Frequency	120Hz ≤ f < 1kHz	1kHz ≤ f < 10kHz	10kHz ≤ f < 100kHz	100kHz ≤ f < 500kHz
Coefficient	0.05	0.3	0.7	1

EC

EL series

- Super low ESR, High ripple current capability
- Rated voltage : 2.5~50V
- Endurance : 5,000 hours at 105°C
- Applications : Servers, LCD-TV power, Inverter, etc.
- RoHS Compliance.
- Halogen Free compliant



SPECIFICATIONS

Items	Conditions	Characteristics
Category Temperature Range	—	-55 to +105°C
Rated Voltage Range	—	2.5 ~ 50V
Capacitance Tolerance	at 20°C, 120 Hz	±20% (M)
Surge Voltage	at 105°C	Rated voltage x 1.15v
Leakage Current	at 20°C after 2 minutes	$I \leq 0.2CV$ or $300(\mu A)$ Whichever is greater measured,after 2minutes application of rated working voltage at +20°C. Please see the attached characteristics list
Dissipation Factor (tan δ)	at 20°C, 120 Hz	Please see the attached characteristics list
Characteristics of Impedance at low, high temperature	at -55°C,100kHz	$Z(-55^{\circ}C) / Z(+20^{\circ}C) \leq 1.25$
	at -25°C,100kHz	$Z(-25^{\circ}C) / Z(+20^{\circ}C) \leq 1.15$
Endurance	The following specifications shall be satisfied when the capacitors are restored to 20°C after the rated voltage is applied for 5,000 hours at 105°C.	Appearance NO significant damage.
		Capacitance change $\leq \pm 20\%$ of the initial value.
		DF (tan δ) $\leq 150\%$ of the initial specified value.
		ESR $\leq 150\%$ of the initial specified value.
		Leakage current \leq The initial specified value.
Damp Heag (Steady State)	The following specifications shall be satisfied when the capacitors are restored to 20°C after subjecting them to store 60°C, 90 to 95% RH for 1,000 hours, without DC applied.	Appearance NO significant damage.
		Capacitance change $\leq \pm 20\%$ of the initial value.
		DF (tan δ) $\leq 150\%$ of the initial specified value.
		ESR $\leq 150\%$ of the initial specified value.
		Leakage current \leq The initial specified value.
Surge Voltage	The capacitors shall be subjected to 1,000 cycles each consisting of charge with the surge voltages specified at 105°C for 30 seconds through aprotective resistor (R = 1 kΩ) and discharge for 5 minutes 30 seconds.	Appearance NO significant damage.
		Capacitance change $\leq \pm 20\%$ of the initial value.
		DF (tan δ) $\leq 150\%$ of the initial specified value.
		ESR $\leq 150\%$ of the initial specified value.
		Leakage current \leq The initial specified value.

※ Note : If any doubt arises, measure the leakage current after following voltage treatment.
Voltage treatment : DC rated voltage are applied to the capacitors for 120 minutes at 105°C.

MARKING AND DIMENSIONS

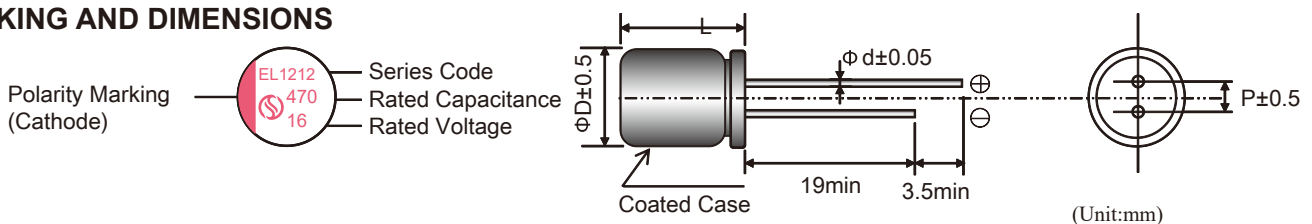

Size	6.3×6	6.3×8	8×8	8×12	10×10	10×12
φ D	6.3	6.3	8	8	10	10
L	L+1.0 max	L+1.5 max	L+1.0 max	L+1.0 max	L+1.0 max	L+1.0 max
φ d	0.45	0.5	0.6	0.6	0.6	0.6
P	2.5	2.5	3.5	3.5	5.0	5.0



EL SERIES STANDARD CHARACTERISTICS LIST

Rated Voltage (S.V.)	Cap (μF)	Size DxL	Leakage current (μA) max. $\times 2$	ESR (mΩ) max. 100k to 300kHz / 20°C	Rated Ripple Current (mA rms) 100kHz / 105°C	D.F. (tanδ) max. 120Hz / 20°C
2.5 (2.9)	220	6.3x6	300	24	2,400	0.12
	560	6.3x8	300	15	3,200	0.12
	1,000	8x8	500	15	3,640	0.12
	1,200	8x12	600	10	5,200	0.12
	1,800	10x12	900	10	5,200	0.12
	2,200	10x12	1,100	10	5,500	0.12
6.3 (7.2)	100	6.3x6	300	24	2,400	0.12
	180	6.3x6	300	24	2,400	0.12
	470	6.3x8	592	15	3,500	0.12
	560	6.3x8	706	15	3,500	0.12
	560	8x8	706	15	4,100	0.12
	680	8x8	856	15	4,300	0.12
	1,000	8x12	1,260	12	5,000	0.12
	1,200	10x10	1,512	15	5,200	0.12
10 (11.5)	120	6.3x6	300	24	2,400	0.12
	330	6.3x8	660	15	3,500	0.12
	560	8x8	1,120	15	4,000	0.12
	680	8x12	1,360	15	4,800	0.12
	1,000	10x10	2,000	15	4,800	0.12
	1,200	10x12	2,400	12	5,500	0.12
16 (18.4)	82	6.3x6	300	24	2,400	0.12
	100	6.3x8	320	15	3,500	0.12
	220	6.3x8	704	15	3,500	0.12
	330	8x8	1,056	15	4,200	0.12
	470	8x12	1,504	12	4,500	0.12
	470	10x12	1,504	10	5,100	0.12
	680	10x10	2,176	15	5,100	0.12
	820	10x12	2,624	15	5,400	0.12
	1,000	10x12	3,200	15	5,400	0.12
25 (28.8)	47	6.3x6	300	40	1,500	0.12
	100	6.3x9	500	30	2,500	0.12
	180	8x8	900	30	3,260	0.12
	220	8x12	1,100	30	3,520	0.12
	330	10x10	1,650	20	3,850	0.12
	470	10x12	2,350	25	4,020	0.12
35 (40.3)	22	6.3x6	300	70	1,450	0.12
	68	6.3x8	476	60	1,520	0.12
	120	8x8	840	30	2,100	0.12
	150	8x12	1,050	26	2,800	0.12
	220	10x10	1,540	30	3,050	0.12
	270	10x12	1,890	26	3,650	0.12

EL

EL SERIES STANDARD CHARACTERISTICS LIST

Rated Voltage (S.V.)	Cap (μF)	Size DxL	Leakage current (μA) max. ※2	ESR (mΩ) max. 100k to 300kHz / 20°C	Rated Ripple Current (mA rms) 100kHz / 105°C	D.F. (tanδ) max. 120Hz / 20°C
50 (57.5)	10	6.3x6	300	90	900	0.12
	33	6.3x8	330	60	1,500	0.12
	47	8x8	470	32	2,000	0.12
	68	8x12	680	28	2,200	0.12
	100	10x10	1,000	32	2,350	0.12
	100	10x12	1,000	28	2,550	0.12

※ 1. Capacitance tolerance : ±20% (M)
 ※ 2. After 2 minutes

FREQUENCY COEFFICIENT FOR RIPPLE CURRENT

Frequency	120Hz ≤ f < 1kHz	1kHz ≤ f < 10kHz	10kHz ≤ f < 100kHz	100kHz ≤ f < 500kHz
Coefficient	0.05	0.3	0.7	1



EH series

- Low ESR, High Voltage, High ripple current capability
- Rated voltage : 35~100V
- Endurance : 2,000hours at 105°C
- Applications : LED Driver, LED Power Supply, etc.
- RoHS compliant
- Halogen Free compliant



EH

SPECIFICATIONS

Items	Conditions	Characteristics
Category Temperature Range	—	-55 to +105°C
Rated Voltage Range	—	35 ~ 100V
Capacitance Tolerance	at 20°C, 120Hz	±20%(M)
Surge Voltage	at 105°C	Rated voltage ×1.15V
Leakage Current	at 20°C after 2 minutes	$I \leq 0.2CV$ or $300(\mu A)$ Whichever is greater measured, after 2 minutes application of rated working voltage at +20°C. Please see the attached characteristics list
Dissipation Factor (tan δ)	at 20°C, 120Hz	Please see the attached characteristics list
Characteristics of Impedance at low, high temperature	at -55°C, 100kHz	$Z(-55^\circ C)/Z(+20^\circ C) \leq 1.25$
	at -25°C, 100kHz	$Z(-25^\circ C)/Z(+20^\circ C) \leq 1.15$
Endurance	The following specifications shall be satisfied when the capacitors are restored to 20°C after the rated voltage is applied for 2,000 hours at 105°C.	Appearance NO significant damage.
		Capacitance change $\leq \pm 20\%$ of the initial value.
		DF(tanδ) $\leq 150\%$ of the initial specified value.
		ESR $\leq 150\%$ of the initial specified value.
Damp Heag (Steady State)	The following specifications shall be satisfied when the capacitors are restored to 20°C after subjecting them to store 60°C, 90 to 95% RH for 1,000 hours, without DC applied.	Appearance NO significant damage.
		Capacitance change $\leq \pm 20\%$ of the initial value.
		DF(tanδ) $\leq 150\%$ of the initial specified value.
		ESR $\leq 150\%$ of the initial specified value.
Surge Voltage	The capacitors shall be subjected to 1,000 cycles each consisting of charge with the surge voltages specified at 105°C for 30 seconds through a protective resistor (R = 1 kΩ) and discharge for 5 minutes 30 seconds.	Appearance NO significant damage.
		Capacitance change $\leq \pm 20\%$ of the initial value.
		DF(tanδ) $\leq 150\%$ of the initial specified value.
		ESR $\leq 150\%$ of the initial specified value.
		Leakage current \leq The initial specified value.

※ Note : If any doubt arises, measure the leakage current after following voltage treatment.
Voltage treatment : DC rated voltage are applied to the capacitors for 120 minutes at 105°C.

MARKING AND DIMENSIONS

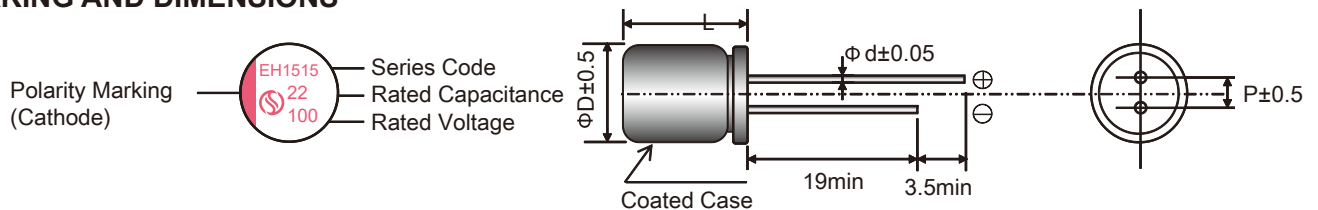

Size	6.3x6	6.3x8	8x7	8x8	8x12	10x10	10x12	10x16
φ D	6.3	6.3	8	8	8	10	10	10
L	L+1 max	L+1.5 max	L+1.0 max	L+1.0 max	L+1.0 max	L+1.0 max	L+1.0 max	L+1.0 max
φ d	0.45	0.5	0.5	0.6	0.6	0.6	0.6	0.6
P	2.5	2.5	3.5	3.5	3.5	5.0	5.0	5.0

EH SERIES STANDARD CHARACTERISTICS LIST

Rated Voltage (S.V.)	Cap (μF)	Size DxL	Leakage current (μA) max. ※2	ESR (mΩ) max. 100k to 300kHz / 20°C	Rated Ripple Current (mA rms) 100kHz / 105°C	D.F. (tanδ) max. 120Hz / 20°C
35 (40.3)	22	6.3x6	300	70	1,450	0.12
	68	6.3x8	476	40	1,500	0.12
	82	8x7	574	60	1,800	0.12
	100	8x8	700	30	2,100	0.12
	100	8x12	700	26	2,300	0.12
	100	10x12	700	24	3,000	0.12
	150	8x8	1,050	30	2,500	0.12
	180	8x12	1,260	26	2,800	0.12
	220	10x10	1,540	26	3,000	0.12
	220	10x12	1,540	24	3,200	0.12
	330	10x12	2,310	24	3,600	0.12
	470	10x16	3,290	20	5,000	0.12
50 (57.5)	12	6.3x8	300	60	1,500	0.12
	33	6.3x8	330	60	1,500	0.12
	33	8x7	330	60	1,500	0.12
	47	8x8	470	32	1,850	0.12
	68	8x12	680	30	2,250	0.12
	47	8x12	470	30	2,250	0.12
	100	10x12	1,000	28	2,560	0.12
	150	10x12	1,500	28	2,620	0.12
63 (72.5)	22	6.3x8	300	60	1,500	0.12
	33	8x8	415	32	2,050	0.12
	33	10x10	415	32	2,200	0.12
	47	8x12	592	26	2,200	0.12
	56	10x10	705	30	2,300	0.12
	82	10x12	1,033	26	2,350	0.12
	100	10x12	1,260	25	2,550	0.12
80 (92.0)	22	8x8	352	35	1,850	0.12
	33	8x12	528	32	1,950	0.12
	47	10x10	752	33	2,200	0.12
	68	10x12	1,088	28	2,350	0.12
100 (115.0)	15	8x12	300	40	1,850	0.12
	22	10x12	440	38	2,250	0.12
	27	10x12	540	38	2,250	0.12

※ 1. Capacitance tolerance : ±20% (M)
 ※ 2. After 2 minutes

FREQUENCY COEFFICIENT FOR RIPPLE CURRENT

Frequency	120Hz ≤ f < 1kHz	1kHz ≤ f < 10kHz	10kHz ≤ f < 100kHz	100kHz ≤ f < 500kHz
Coefficient	0.05	0.3	0.7	1

EH

ET series

- High temperature, low ESR, High ripple current capability
- Rated voltage : 4~50V
- Endurance : 1,000hours at 125°C
- Applications : DC-DC Converters, Voltage Regulators, Decoupling Applications for Computer Motherboards, etc.
- RoHS compliant
- Halogen Free compliant



ET

SPECIFICATIONS

Items	Conditions	Characteristics
Category Temperature Range	—	-55 to +125°C
Rated Voltage Range	—	4 ~ 50V
Capacitance Tolerance	at 20°C, 120Hz	±20%(M)
Surge Voltage	at 125°C	Rated voltage × 1.15V
Leakage Current	at 20°C after 2 minutes	$I \leq 0.2CV$ or $300(\mu A)$ Whichever is greater measured, after 2 minutes application of rated working voltage at +20°C. Please see the attached characteristics list
Dissipation Factor (tan δ)	at 20°C, 120Hz	Please see the attached characteristics list
Characteristics of Impedance at low, high temperature	at -55°C, 100kHz	$Z(-55^\circ C)/Z(+20^\circ C) \leq 1.25$
	at -25°C, 100kHz	$Z(-25^\circ C)/Z(+20^\circ C) \leq 1.15$
Endurance	The following specifications shall be satisfied when the capacitors are restored to 20°C after the rated voltage is applied for 1,000 hours at 125°C.	Appearance NO significant damage.
		Capacitance change $\leq \pm 20\%$ of the initial value.
		DF(tanδ) $\leq 150\%$ of the initial specified value.
		ESR $\leq 150\%$ of the initial specified value.
		Leakage current \leq The initial specified value.
Damp Heat (Steady State)	The following specifications shall be satisfied when the capacitors are restored to 20°C after subjecting them to store at 60°C, 90 to 95% RH for 1,000 hours, without DC applied.	Appearance NO significant damage.
		Capacitance change $\leq \pm 20\%$ of the initial value.
		DF(tanδ) $\leq 150\%$ of the initial specified value.
		ESR $\leq 150\%$ of the initial specified value.
		Leakage current \leq The initial specified value.
Surge Voltage	The capacitors shall be subjected to 1,000 cycles each consisting of charge with the surge voltages specified at 105°C for 30 seconds through a protective resistor (R=1kΩ) and discharge for 5 minutes 30 seconds.	Appearance NO significant damage.
		Capacitance change $\leq \pm 20\%$ of the initial value.
		DF(tanδ) $\leq 150\%$ of the initial specified value.
		ESR $\leq 150\%$ of the initial specified value.
		Leakage current \leq The initial specified value.

※ Note: If any doubt arises, measure the leakage current after following voltage treatment.
Voltage treatment : DC rated voltage are applied to the capacitors for 120 minutes at 125°C.

MARKING AND DIMENSIONS

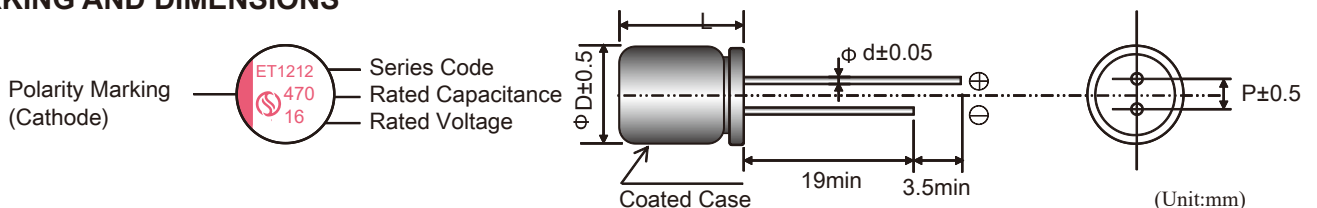

Size	6.3x6	6.3x8	8x7	8x8	8x12	10x10	10x12
φD	6.3	6.3	8	8	8	10	10
L	L+1.0 max	L+1.5 max	L+1.0 max	L+1.5 max	L+1.0 max	L+1.0 max	L+1.0 max
φd	0.45	0.5	0.5	0.6	0.6	0.6	0.6
P	2.5	2.5	3.5	3.5	3.5	5.0	5.0

ET SERIES STANDARD CHARACTERISTICS LIST

Rated voltage (S.V.)	Cap (μF)	Size DxL	Leakage current (uA) max. ※2	ESR (mΩ) max. 100k to 300kHz / 20°C	Rated Ripple Current (mA rms)		D.F. (tanδ) max. 120Hz / 20°C
					105°C 100kHz	125°C 100kHz	
4 (4.6)	100	6.3×6	300	40	2390	797	0.12
	330	6.3×8	300	20	3200	1067	0.12
	560	6.3×8	448	20	3200	1067	0.12
	1,000	8×8	800	20	3800	1267	0.12
	1,200	8×12	960	16	4200	1400	0.12
	2,500	10×12	2,000	16	5460	1820	0.12
6.3 (7.2)	100	6.3×6	300	40	2100	700	0.12
	470	6.3×8	592	20	3100	1033	0.12
	560	8×8	705	20	4300	1433	0.12
	1,000	8×12	1,260	16	5100	1700	0.12
	1,200	8×12	1,512	16	5100	1700	0.12
	1,500	10×10	1,890	20	5200	1733	0.12
	1,800	10×12	2,268	16	5440	1813	0.12
10 (11.5)	100	6.3×6	300	40	1800	600	0.12
	330	6.3×8	660	20	2360	787	0.12
	330	8×7	660	40	2560	853	0.12
	560	8×8	1,120	20	3200	1067	0.12
	820	8×12	1,640	16	4200	1400	0.12
	1,000	10×10	2,000	20	5120	1707	0.12
	1,200	10×12	2,400	16	5600	1867	0.12
16 (18.4)	47	6.3×6	300	30	1620	540	0.12
	82	6.3×6	300	30	1620	540	0.12
	100	6.3×8	320	20	2120	707	0.12
	330	8×8	1,056	20	4300	1433	0.12
	470	8×12	1,504	16	4500	1500	0.12
	560	10×12	1,792	16	4700	1567	0.12
	820	10×12	2,624	16	4700	1567	0.12
25 (28.8)	47	6.3×6	300	50	2000	667	0.12
	100	6.3×8	500	30	2000	667	0.12
	180	8×8	900	28	3100	1033	0.12
	220	8×12	1,100	26	3600	1200	0.12
	330	10×12	1,650	24	4250	1417	0.12
	470	10×12	2,350	24	4200	1400	0.12
35 (40.3)	22	6.3×6	300	70	1450	483	0.12
	68	6.3×8	476	60	1500	500	0.12
	120	8×8	840	30	2200	733	0.12
	150	8×12	1,050	28	2600	867	0.12
	220	10×10	1,540	28	2950	983	0.12
	270	10×12	1,890	28	3200	1067	0.12
50 (57.5)	10	6.3×6	300	60	1400	467	0.12
	33	6.3×8	330	60	1500	500	0.12
	47	8×8	470	30	2000	667	0.12
	68	8×12	680	28	2200	733	0.12
	100	10×10	1,000	28	2300	767	0.12
	100	10×12	1,000	28	2500	833	0.12

※ 1. Capacitance tolerance : ±20%(M)
 ※ 2. After 2 minutes

FREQUENCY COEFFICIENT FOR RIPPLE CURRENT

Frequency	120Hz ≤ f < 1kHz	1kHz ≤ f < 10kHz	10kHz ≤ f < 100kHz	100kHz ≤ f < 500kHz
Coefficient	0.05	0.3	0.7	1

ET

EP series

- High temperature, low ESR, High ripple current capability
- Rated voltage : 6.3~35V
- Endurance : 2,000hours at 125°C
- Applications : Lamps Power, LED Power, Server Equipment.
- RoHS compliant
- Halogen Free compliant



EP

SPECIFICATIONS

Items	Conditions	Characteristics
Category Temperature Range	—	-55 to +125°C
Rated Voltage Range	—	6.3 ~ 35V
Capacitance Tolerance	at 20°C,120Hz	±20%(M)
Surge Voltage	at 125°C	Rated voltage ×1.15V
Leakage Current	at 20°C after 2 minutes	I ≤ 0.2CV or 300(μA) Whichever is greater measured,after 2minutes application of rated working voltage at +20°C. Please see the attached characteristics list
Dissipation Factor (tan δ)	at 20°C,120Hz	Please see the attached characteristics list
Characteristics of Impedance at low, high temperature	at -55°C,100kHz	Z(-55°C)/Z(+20°C) ≤ 1.25
	at +25°C,100kHz	Z(-25°C)/Z(+20°C) ≤ 1.15
Endurance	The following specifications shall be satisfied when the capacitors are restored to 20°C after the rated voltage is applied for 2,000 hours at 125°C.	Appearance NO significant damage.
		Capacitance change ≤ ±20% of the initial value.
		DF(tanδ) ≤ 150% of the initial specified value.
		ESR ≤ 150% of the initial specified value.
		Leakage current ≤ The initial specified value.
Damp Heag (Steady State)	The following specifications shall be satisfied when the capacitors are restored to 20°C after subjecting them to store at 60°C, 90 to 95% RH for 1,000 hours ,without DC applied.	Appearance NO significant damage.
		Capacitance change ≤ ±20% of the initial value.
		DF(tanδ) ≤ 150% of the initial specified value.
		ESR ≤ 150% of the initial specified value.
		Leakage current ≤ The initial specified value.
Surge Voltage	The capacitors shall be subjected to 1,000 cycles each consisting of charge with the surge voltages specified at 105°C for 30 seconds through aprotective resistor (R=1kΩ) and discharge for 5 minutes 30 seconds	Appearance NO significant damage.
		Capacitance change ≤ ±20% of the initial value.
		DF(tanδ) ≤ 150% of the initial specified value.
		ESR ≤ 150% of the initial specified value.
		Leakage current ≤ The initial specified value.

※ Note:If any doubt arises,measure the leakage current after following voltage treatment.
Voltage treatment :DC rated voltage are applied to the capacitors for 120 minutes at 125°C.

MARKING AND DIMENSIONS

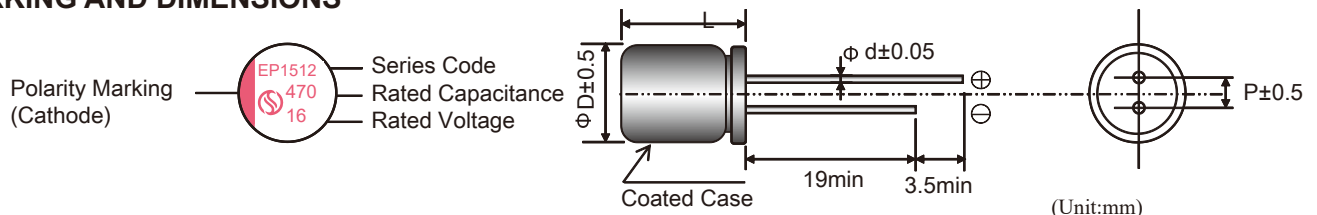

Size	6.3x8	8x8	8x12	10x10	10x12
φ D	6.3	8.0	8.0	10.0	10.0
L	L+1.5 max	L+1.5 max	L+1.0 max	L+1.0 max	L+1.0 max
φ d	0.5	0.6	0.6	0.6	0.6
P	2.5	3.5	3.5	5.0	5.0

EP SERIES STANDARD CHARACTERISTICS LIST

Rated Voltage (S.V.)	Cap (μF)	Size DxL	Leakage current (μA) max. ※2	ESR (mΩ) max. 100k to 300kHz / 20°C	Rated Ripple Current (mA rms)		D.F. (tanδ) max. 120Hz / 20°C
					105°C 100kHz	125°C 100kHz	
6.3 (7.2)	470	6.3x8	592	25	3,800	1,267	0.12
	680	8x8	857	25	4,000	1,333	0.12
	1,000	8x12	1,260	20	4,200	1,400	0.12
	1,200	10x10	1,512	25	5,500	1,833	0.12
	1,800	10x12	2,268	20	6,100	2,033	0.12
10 (11.5)	330	6.3x8	660	25	3,700	1,233	0.12
	560	8x8	1,120	25	4,000	1,333	0.12
	680	8x12	1,360	20	4,500	1,500	0.12
	820	10x10	1,640	25	4,200	1,400	0.12
	1,000	10x10	2,000	25	4,500	1,500	0.12
	1,200	10x12	2,400	20	5,600	1,867	0.12
16 (18.4)	220	6.3x8	704	25	2,850	950	0.12
	330	8x8	1,056	25	4,000	1,333	0.12
	470	8x12	1,504	20	4,500	1,500	0.12
	680	10x10	2,176	25	5,100	1,700	0.12
	820	10x12	2,624	20	5,600	1,867	0.12
20 (23.0)	120	6.3x8	480	25	2,510	837	0.12
	220	8x8	880	25	2,750	917	0.12
	270	8x12	1,080	20	2,950	983	0.12
	330	10x10	1,320	25	4,700	1,567	0.12
	470	10x12	1,880	20	4,950	1,650	0.12
25 (28.8)	100	6.3x8	500	40	2,380	793	0.12
	180	8x8	900	30	2,900	967	0.12
	220	8x8	1,100	28	3,500	1,167	0.12
	330	10x10	1,650	30	4,250	1,417	0.12
	470	10x12	2,350	28	4,500	1,500	0.12
35 (40.3)	56	6.3x8	392	60	2,300	767	0.12
	100	8x8	700	50	2,500	833	0.12
	120	8x12	840	30	2,950	983	0.12
	150	10x10	1,050	30	2,950	983	0.12
	220	10x12	1,540	28	3,400	1,133	0.12

※ 1. Capacitance tolerance : ±20% (M)
 ※ 2. After 2 minutes

FREQUENCY COEFFICIENT FOR RIPPLE CURRENT

Frequency	120Hz ≤ f < 1kHz	1kHz ≤ f < 10kHz	10kHz ≤ f < 100kHz	100kHz ≤ f < 500kHz
Coefficient	0.05	0.3	0.7	1

EP

PC series

- Low ESR at high frequency range.
- Rated voltage :2.5~63V.
- Endurance:15,000hours at 105°C
- Applications:LCD Monitor,LCD-TV,D/A Inverter,SPS,D/D Converter.etc.
- ROHS compliant
- Halogen Free compliant



PC

SPECIFICATIONS

Items	Conditions	Characteristics
Category Temperature Range	—	-55 to +105°C
Rated Voltage Range	—	2.5~63V
Capacitance Tolerance	at 20°C,120HZ	±20%(M)
Surge Voltage	at 105°C	Rated voltage ×1.15V
Leakage Current	at 20°CAfter 2 minutes	I≤0.2CV or 300(μA) Whichever is greater measured,after 2minutes application of rated working voltage at +20°C.
Dissipation Factor (tan δ)	at 20°C,120Hz	Please see the attached characteristics list
Characteristics of Impedance at low, high temperature	at -55°C,100kHz	Z(-55°C)/Z(+20°C) ≤ 1.25
	at -25°C,100kHz	Z(-25°C)/Z(+20°C) ≤ 1.15
Endurance	The following specifications shall be satisfied when the capacitors are restored to 20°Cafter the rated voltage is applied for 15,000 hours at 105°C.	Appearance NO significant damage.
		Capacitance change ≤±20% of the initial value.
		DF(tanδ) ≤150% of the initial specified value.
		ESR ≤150% of the initial specified value.
		Leakage current ≤The initial specified value.
Damp Heag (Steady State)	The following specifications shall be satisfied when the capacitors are restored to 20°C after subjecting them to store at 60°C, 90 to 95% RH for 1,000 hours ,without DC applied.	Appearance NO significant damage.
		Capacitance change ≤±20% of the initial value.
		DF(tanδ) ≤150% of the initial specified value.
		ESR ≤150% of the initial specified value.
		Leakage current ≤The initial specified value.
Surge Voltage	The capacitors shall be subjected to 1,000 cycles each consisting of charge with the surge voltages specified at 105°C for 30 seconds through aprotective resistor (R=1kΩ) and discharge for 5 minutes 30seconds	Appearance NO significant damage.
		Capacitance change ≤±20% of the initial value.
		DF(tanδ) ≤150% of the initial specified value.
		ESR ≤150% of the initial specified value.
		Leakage current ≤The initial specified value.

※ Note:If any doubt arises,measure the leakage current after following voltage treatment.
Voltage treatment :DC rated voltage are applied to the capacitors for 120 minutes at 105°C.

MARKING AND DIMENSIONS

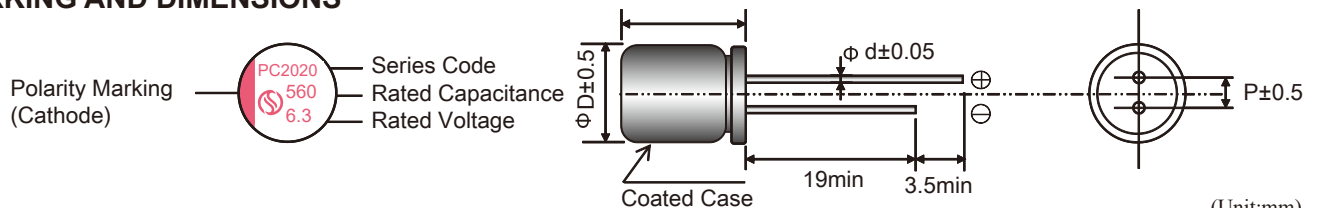

Size Code	5X6	6.3X6	6.3X9	6.3X11	8X8	8X12	8X14	8X16	8X20	10X12	10X14	10X16
φ D	5	6.3	6.3	6.3	8	8	8	8	8	10.0	10.0	10.0
L	L+1.0 max	L+1.0 max	L+1 max	L+1.0 max	L+1.5 max	L+1.0 max	L+1.0 max	L+1.0 max	L+1.5 max	L+1.0 max	L+1.0 max	L+1.5 max
φ d	0.45	0.45	0.5	0.5	0.6	0.6	0.6	0.6	0.6	0.6	0.6	0.6
P	2	2.5	2.5	2.5	3.5	3.5	3.5	3.5	3.5	5.0	5.0	5.0

(Unit:mm)

PC SERIES STANDARD CHARACTERISTICS LIST

Rated Voltage (S.V.)	Cap (μF)	Size DxL	Leakage current (μA) max. ※2	ESR (mΩ) max. 100k to 300kHz / 20°C	Rated Ripple Current (mA rms) 100kHz / 105°C	D.F. (tanδ) max. 120Hz / 20°C
2.5 (2.9)	560	6.3×9	300	8	5,080	0.12
	560	8×8	300	7	5,820	0.12
	820	6.3×9	410	8	5,080	0.12
	1200	8×8	600	7	5,580	0.12
	1500	8×12	750	7	5,820	0.12
	2,700	10×12	1,350	7	6,100	0.12
4 (4.6)	560	6.3×9	448	8	5,080	0.12
	560	8×8	448	7	5,580	0.12
	680	8×8	544	7	5,580	0.12
	820	8×12	656	7	5,820	0.12
	2200	10×12	1,760	7	6,100	0.12
6.3 (7.2)	100	5×6	300	13	1,500	0.12
	220	5×8	300	12	2,400	0.12
	470	6.3×9	592	10	4,500	0.12
	560	6.3×9	706	10	5,080	0.12
	560	8×8	706	10	5,580	0.12
	1,000	8×12	1,260	7	5,820	0.12
	1,000	10×12	1,260	7	6,200	0.12
	2,200	10×12	2,772	7	6,200	0.12
10 (11.5)	220	6.3×9	440	10	2,820	0.12
	270	6.3×9	540	10	5,580	0.12
	560	8×8	1,120	8	5,580	0.12
	680	8×8	1,360	9	5,580	0.12
	820	8×12	1,640	9	5,820	0.12
	1,000	10×12	2,000	9	6,100	0.12
	1500	10×12	3,000	9	6,100	0.12
16 (18.4)	82	6.3×6	300	30	2,200	0.12
	100	6.3×6	320	30	2,200	0.12
	220	6.3×9	704	15	3,500	0.12
	270	6.3×9	864	15	3,500	0.12
	330	6.3×11	1,056	15	3,500	0.12
	470	8×8	1,504	13	4,500	0.12
	470	8×12	1,504	13	5,400	0.12
	470	10×12	1,504	13	6,100	0.12
	560	8×12	1,792	16	5,400	0.12
	680	10×12	2,176	16	6,100	0.12
	820	10×12	2,624	10	6,100	0.12
	1000	8×16	3,200	10	6,100	0.12
	1000	10×12	3,200	10	6,100	0.12
	1500	8×20	4,800	8	6,100	0.12
	1500	10×16	4,800	8	6,500	0.12
1800	10×20	5,760	8	6,800	0.12	
2200	10×20	7,040	8	6,800	0.12	

※ 1. Capacitance tolerance : ±20%(M)
 ※ 2. After 2 minutes

PC

PC SERIES STANDARD CHARACTERISTICS LIST

Rated Voltage (S.V.)	Cap (μF)	Size DxL	Leakage current (μA) max. ※2	ESR (mΩ) max. 100k to 300kHz / 20°C	Rated Ripple Current (mA rms) 100kHz / 105°C	D.F. (tanδ) max. 120Hz / 20°C
20 (23)	22	6.3×6	300	60	1,450	0.12
	82	6.3×6	328	60	1,450	0.12
	220	6.3×9	880	40	1,620	0.12
	330	8×8	1,320	40	2,400	0.12
	470	8×12	1,880	24	3,320	0.12
	820	10×12	3,280	20	3800	0.12
25 (28.8)	6.8	6.3×6	300	80	1,200	0.12
	47	6.3×6	300	40	2,000	0.12
	100	6.3×9	500	30	2150	0.12
	180	8×8	900	30	2580	0.12
	220	8×12	1100	25	3200	0.12
	330	10×10	1650	28	3800	0.12
	470	10×12	2350	25	4100	0.12
	560	10×14	2800	16	4500	0.12
	680	8×16	3400	16	4600	0.12
820	10×14	4100	16	5000	0.12	
35 (40.3)	22	6.3×6	300	70	1,450	0.12
	68	6.3×9	476	40	1,500	0.12
	82	8×7	574	60	1,800	0.12
	100	8×8	700	30	2,100	0.12
	100	8×12	700	26	2,300	0.12
	100	10×12	700	24	3,000	0.12
	150	8×8	1,050	30	2,500	0.12
	180	8×12	1,260	26	2,800	0.12
	220	10×10	1,540	26	3,000	0.12
	220	10×12	1,540	24	3,200	0.12
	330	10×12	2,310	24	3,600	0.12
	470	10×16	3,290	20	5,000	0.12
	50 (57.5)	12	6.3×9	300	60	1,500
33		6.3×9	330	60	1,500	0.12
33		8×7	330	60	1,500	0.12
47		8×8	470	32	1,850	0.12
68		8×12	680	30	2,250	0.12
47		8×12	470	30	2,250	0.12
100		10×12	1,000	28	2,560	0.12
150		10×12	1,500	28	2,620	0.12
63 (72.5)	22	6.3×9	300	60	1,500	0.12
	33	8×8	415	32	2,050	0.12
	33	10×10	415	32	2,200	0.12
	47	8×12	592	26	2,200	0.12
	56	10×10	705	30	2,300	0.12
	82	10×12	1,033	26	2,350	0.12
	100	10×12	1,260	25	2,550	0.12

※ 1. Capacitance tolerance : ±20%(M)

※ 2. After 2 minutes

FREQUENCY COEFFICIENT FOR RIPPLE CURRENT

Frequency	120Hz ≤ f < 1kHz	1kHz ≤ f < 10kHz	10kHz ≤ f < 100kHz	100kHz ≤ f < 500kHz
Coefficient	0.05	0.3	0.7	1

PC

PL series

- Super low ESR, High ripple current capability
- Rated voltage :2.5~50V
- Endurance:20,000hours at 105°C
- Applications: Servers, LCD-TV power, Inverter etc.
- ROHS compliant
- Halogen Free compliant



SPECIFICATIONS

Items	Conditions	Characteristics	
Category Temperature Range	—	-55 to +105°C	
Rated Voltage Range	—	2.5~50V	
Capacitance Tolerance	at 20°C, 120HZ	±20%(M)	
Surge Voltage	at 105°C	Rated voltage ×1.15V	
Leakage Current	at 20°C After 2 minutes	$I \leq 0.2CV$ or $300(\mu A)$ Whichever is greater measured, after 2 minutes application of rated working voltage at +20°C.	
Dissipation Factor (tan δ)	at 20°C, 120Hz	Please see the attached characteristics list	
Characteristics of Impedance at low, high temperature	at -55°C, 100kHz	$Z(-55^\circ C)/Z(+20^\circ C) \leq 1.25$	
	at -25°C, 100kHz	$Z(-25^\circ C)/Z(+20^\circ C) \leq 1.15$	
Endurance	The following specifications shall be satisfied when the capacitors are restored to 20°C after the rated voltage is applied for 20,000 hours at 105°C.	Appearance	NO significant damage.
		Capacitance change	$\leq \pm 20\%$ of the initial value.
		DF(tanδ)	$\leq 150\%$ of the initial specified value.
		ESR	$\leq 150\%$ of the initial specified value.
		Leakage current	\leq The initial specified value.
Damp Heat (Steady State)	The following specifications shall be satisfied when the capacitors are restored to 20°C after subjecting them to store at 60°C, 90 to 95% RH for 1,000 hours, without DC applied.	Appearance	NO significant damage.
		Capacitance change	$\leq \pm 20\%$ of the initial value.
		DF(tanδ)	$\leq 150\%$ of the initial specified value.
		ESR	$\leq 150\%$ of the initial specified value.
		Leakage current	\leq The initial specified value.
Surge Voltage	The capacitors shall be subjected to 1,000 cycles each consisting of charge with the surge voltages specified at 105°C for 30 seconds through a protective resistor (R=1kΩ) and discharge for 5 minutes 30seconds	Appearance	NO significant damage.
		Capacitance change	$\leq \pm 20\%$ of the initial value.
		DF(tanδ)	$\leq 150\%$ of the initial specified value.
		ESR	$\leq 150\%$ of the initial specified value.
		Leakage current	\leq The initial specified value.

※ Note: If any doubt arises, measure the leakage current after following voltage treatment.
Voltage treatment :DC rated voltage are applied to the capacitors for 120 minutes at 105°C.

MARKING AND DIMENSIONS

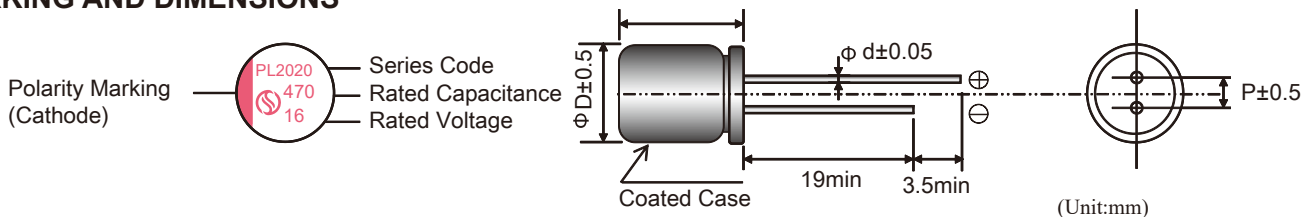

Size Code	6.3×6	6.3×9	8×8	8×12	10×10	10×12
φ D	6.3	6.3	8	8	10	10
L	L+1.0 max	L+1.0 max	L+1.5 max	L+1.0 max	L+1.0 max	L+1.0 max
φ d	0.5	0.5	0.6	0.6	0.6	0.6
P	2.5	2.5	3.5	3.5	5.0	5.0

PL

PL SERIES STANDARD CHARACTERISTICS LIST

Rated Voltage (S.V.)	Cap (μF)	Size DxL	Leakage current (μA) max. ※2	ESR (mΩ) max. 100k to 300kHz / 20°C	Rated Ripple Current (mA rms) 100kHz / 105°C	D.F. (tanδ) max. 120Hz / 20°C
2.5 (2.9)	220	6.3×6	300	24	2,400	0.12
	560	6.3×9	300	15	3,200	0.12
	1000	8×8	500	15	3,640	0.12
	1200	8×12	600	10	5,200	0.12
	1800	10×12	900	10	5,200	0.12
	2,200	10×12	1,100	10	5,500	0.12
6.3 (7.2)	100	6.3×6	300	24	2,400	0.12
	180	6.3×6	300	24	2,400	0.12
	470	6.3×9	592	20	3,500	0.12
	560	6.3×9	706	20	3,500	0.12
	560	8×8	706	15	4,100	0.12
	680	8×8	856	15	4,300	0.12
	1000	8×12	1,260	12	5,000	0.12
	1,200	10×10	1,512	15	5,200	0.12
	1800	10×12	2,268	12	5,500	0.12
10 (11.5)	120	6.3×6	300	24	2,400	0.12
	330	6.3×9	660	15	3,500	0.12
	560	8×8	1,120	15	4,000	0.12
	680	8×12	1,360	15	4,800	0.12
	1000	10×10	2,000	15	4,800	0.12
	1200	10×12	2,400	12	5,500	0.12
16 (18.4)	82	6.3×6	300	24	2,400	0.12
	100	6.3×9	320	15	3500	0.12
	220	6.3×9	704	15	3500	0.12
	330	8×8	1056	15	4200	0.12
	470	8×12	1504	12	4500	0.12
	470	10×12	1504	10	5100	0.12
	680	10×10	2176	15	5100	0.12
	820	10×12	2624	15	5400	0.12
	1000	10×12	3200	15	5400	0.12
25 (28.8)	47	6.3×6	300	40	1500	0.12
	100	6.3×9	500	30	2500	0.12
	180	8×8	900	30	3260	0.12
	220	8×12	1100	30	3520	0.12
	330	10×10	1650	20	3850	0.12
	470	10×12	2350	25	4020	0.12
35 (40.3)	22	6.3×6	300	70	1450	0.12
	68	6.3×9	476	60	1520	0.12
	120	8×8	840	30	2100	0.12
	150	8×12	1050	26	2800	0.12
	220	10×10	1540	30	3050	0.12
	270	10×12	1890	26	3650	0.12
50 (57.5)	10	6.3×6	300	90	900	0.12
	33	6.3×9	330	60	1500	0.12
	47	8×8	470	32	2000	0.12
	68	8×12	680	28	2200	0.12
	100	10×10	1000	32	2350	0.12
	100	10×12	1000	28	2550	0.12

※ 1. Capacitance tolerance : ±20%(M)

※ 2. After 2 minutes

FREQUENCY COEFFICIENT FOR RIPPLE CURRENT

Frequency	120Hz ≤ f < 1kHz	1kHz ≤ f < 10kHz	10kHz ≤ f < 100kHz	100kHz ≤ f < 500kHz
Coefficient	0.05	0.3	0.7	1

VA series

- Standard SMD type
- Rated voltage : 2.5~25V
- Endurance : 2,000 hours at 105°C
- Applications : motherboards, server, VGA, etc.
- RoHS compliance
- Halogen Free compliant



SPECIFICATIONS

Items	Conditions	Characteristics
Category Temperature Range	—	-55 to +105°C
Rated Voltage Range	—	2.5 ~ 25V
Capacitance Tolerance	at 20°C, 120Hz	±20%(M)
Surge Voltage	at 105°C	Rated voltage × 1.15V
Leakage Current	at 20°C after 2 minutes	$I \leq 0.2CV$ or $300(\mu A)$ Whichever is greater measured, after 2 minutes application of rated working voltage at +20°C. Please see the attached characteristics list
Dissipation Factor ($\tan \delta$)	at 20°C, 120Hz	Please see the attached characteristics list
Characteristics of Impedance at low, high temperature	at -55°C, 100kHz	$Z(-55^\circ C)/Z(+20^\circ C) \leq 1.25$
	at -25°C, 100kHz	$Z(-25^\circ C)/Z(+20^\circ C) \leq 1.15$
Endurance	The following specifications shall be satisfied when the capacitors are restored to 20°C after the rated voltage is applied for 2,000 hours at 105°C.	Appearance NO significant damage.
		Capacitance change $\leq \pm 20\%$ of the initial value.
		DF ($\tan \delta$) $\leq 150\%$ of the initial specified value.
		ESR $\leq 150\%$ of the initial specified value.
		Leakage current \leq The initial specified value.
Damp Heat (Steady State)	The following specifications shall be satisfied when the capacitors are restored to 20°C after subjecting them to store at 60°C, 90 to 95% RH for 1,000 hours, without DC applied.	Appearance NO significant damage.
		Capacitance change $\leq \pm 20\%$ of the initial value.
		DF ($\tan \delta$) $\leq 150\%$ of the initial specified value.
		ESR $\leq 150\%$ of the initial specified value.
		Leakage current \leq The initial specified value.
Surge Voltage	The capacitors shall be subjected to 1,000 cycles each consisting of charge with the surge voltages specified at 105°C for 30 seconds through a protective resistor (R=1kΩ) and discharge for 5 minutes 30 seconds.	Appearance NO significant damage.
		Capacitance change $\leq \pm 20\%$ of the initial value.
		DF ($\tan \delta$) $\leq 150\%$ of the initial specified value.
		ESR $\leq 150\%$ of the initial specified value.
		Leakage current \leq The initial specified value.

※ Note: If any doubt arises, measure the leakage current after following voltage treatment.
Voltage treatment : DC rated voltage are applied to the capacitors for 120 minutes at 105°C.

MARKING AND DIMENSIONS

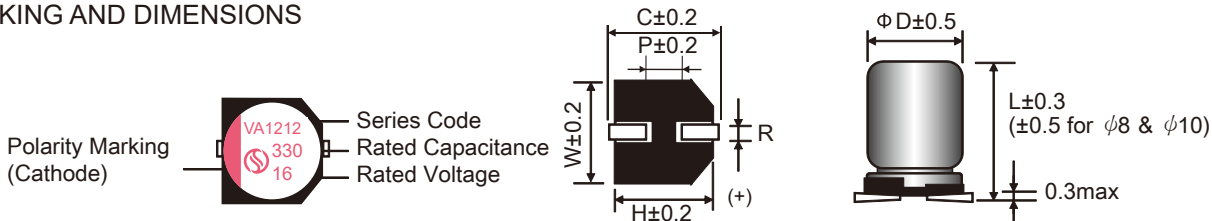

(Unit:mm)

φ D×L	φ D	L	W	H	C	R	P
5×6	5.0	6.0	5.3	5.3	6.0	0.5~0.8	1.4
6.3×6	6.3	6.0	6.6	6.6	7.3	0.5~0.8	2.1
6.3×7	6.3	7.0	6.6	6.6	7.3	0.5~0.8	2.1
6.3×9.5	6.3	9.5	6.6	6.6	7.3	0.5~0.8	2.1
8×7	8.0	7.0	8.3	8.3	9.0	0.5~0.8	3.2
8×9.5	8.0	9.5	8.3	8.3	9.0	0.8~1.1	3.2
8×12	8.0	12.0	8.3	8.3	9.0	0.8~1.1	3.2
10×10.5	10.0	10.5	10.3	10.3	11.0	0.8~1.1	4.6
10×12.5	10.0	12.5	10.3	10.3	11.0	0.8~1.1	4.6

VA

VA SERIES STANDARD CHARACTERISITICS LIST

Rated Voltage (S.V.)	Cap (μF)	Size DxL	Leakage current (μA) max. ※2	ESR (mΩ) max. 100k to 300kHz / 20°C	Rated Ripple Current (mA rms) 100kHz / 105°C	D.F. (tanδ) max. 120Hz / 20°C
2.5 (2.9)	220	6.3×6	300	25	2,390	0.12
	330	6.3×6	300	25	2,390	0.12
	560	6.3×7	300	25	2,390	0.12
	820	6.3×9.5	410	20	3,000	0.12
	1,200	8×9.5	600	20	4,520	0.12
	1,500	8×9.5	750	20	4,520	0.12
	1,800	8×12	900	13	4,520	0.12
	2,200	10×10.5	1,100	18	4,520	0.12
	2,700	10×12.5	1,350	15	5,200	0.12
4 (4.6)	220	6.3×6	300	25	2,000	0.12
	560	6.3×9.5	448	20	4,500	0.12
	820	8×9.5	656	20	4,500	0.12
	1,000	8×9.5	800	20	4,500	0.12
	1,200	8×12	960	15	4,820	0.12
	1,500	10×10.5	1,200	15	4,820	0.12
	2,200	10×12.5	1,760	15	5,200	0.12
6.3 (7.2)	100	6.3×6	300	25	2,400	0.12
	220	6.3×6	300	25	2,400	0.12
	220	8×7	300	25	3,020	0.12
	560	6.3×9.5	705	20	3,020	0.12
	820	8×9.5	1,033	20	4,500	0.12
	1,000	8×9.5	1,260	20	4,500	0.12
	1,200	8×12	1,512	15	4,800	0.12
	1,500	10×10.5	1,890	15	4,950	0.12
	2,200	10×12.5	2,772	15	5,200	0.12
10 (11.5)	33	5×6	300	45	1,100	0.12
	100	6.3×6	300	30	1,700	0.12
	150	6.3×6	300	45	1,700	0.12
	330	6.3×9.5	660	45	2,050	0.12
	560	8×9.5	1,120	35	2,560	0.12
	680	8×9.5	1,360	35	2,560	0.12
	820	8×12	1,640	17	3,950	0.12
	1,000	10×10.5	2,000	15	3,950	0.12
	1,500	10×12.5	3,000	13	5,230	0.12
16 (18.4)	22	5×6	300	40	1,000	0.12
	100	6.3×6	320	35	1,620	0.12
	270	6.3×9.5	864	20	2,500	0.12
	270	8×9.5	864	20	3,200	0.12
	330	8×9.5	1,056	20	3,690	0.12
	470	8×9.5	1,504	20	3,890	0.12
	560	8×12	1,792	20	3,940	0.12
	680	10×10.5	2,176	20	4,220	0.12
	820	10×12.5	2,624	16	4,720	0.12
1,000	10×12.5	3,200	16	5,200	0.12	

※ 1. Capacitance tolerance : ±20% (M)
 ※ 2. After 2 minutes

VA SERIES STANDARD CHARACTERISTICS LIST

Rated Voltage (S.V.)	Cap (μF)	Size DxL	Leakage current (μA) max. ※2	ESR (mΩ) max. 100k to 300kHz / 20°C	Rated Ripple Current (mA rms) 100kHz / 105°C	D.F. (tanδ) max. 120Hz / 20°C
20 (23.0)	68	6.3x6	300	38	1,450	0.12
	180	6.3x9.5	720	30	2,450	0.12
	330	8x9.5	1,320	30	3,000	0.12
	470	8x12	1,880	28	3,320	0.12
	560	10x10.5	2,240	28	3,320	0.12
	680	10x12.5	2,720	28	4,220	0.12
25 (28.8)	47	6.3x6	300	40	1,200	0.12
	100	6.3x9.5	500	30	2,000	0.12
	100	8x7	500	40	2,000	0.12
	150	8x9.5	750	35	3,000	0.12
	220	8x12	1,100	28	3,500	0.12
	330	10x10.5	1,650	30	3,800	0.12
	470	10x12.5	2,350	28	4,000	0.12

※ 1. Capacitance tolerance : ±20% (M)

※ 2. After 2 minutes

FREQUENCY COEFFICIENT FOR RIPPLE CURRENT

Frequency	120Hz ≤ f < 1kHz	1kHz ≤ f < 10kHz	10kHz ≤ f < 100kHz	100kHz ≤ f < 500kHz
Coefficient	0.05	0.3	0.7	1.0

VA

VC series

- Super low ESR, High ripple current capability
- Rated voltage : 2.5~16V.
- Endurance : 2,000hours at 105°C
- Applications : motherboards, servers, VGA, etc.
- RoHS compliant
- Halogen Free compliant



VC

SPECIFICATIONS

Items	Conditions	Characteristics
Category Temperature Range	—	-55 to +105°C
Rated Voltage Range	—	2.5 ~ 16V
Capacitance Tolerance	at 20°C, 120 Hz	±20% (M)
Surge Voltage	at 105°C	Rated voltage x1.15V
Leakage Current	at 20°C after 2 minutes	$I \leq 0.2CV$ or $300(\mu A)$ Whichever is greater measured,after 2minutes application of rated working voltage at +20°C. Please see the attached characteristics list
Dissipation Factor (tan δ)	at 20°C, 120 Hz	Please see the attached characteristics list
Characteristics of Impedance at low, high temperature	at -55°C,100kHz	$Z(-55^{\circ}C) / Z(+20^{\circ}C) \leq 1.25$
	at -25°C,100kHz	$Z(-25^{\circ}C)/Z(+20^{\circ}C) \leq 1.15$
Endurance	The following specifications shall be satisfied when the capacitors are restored to 20°C after the rated voltage is applied for 2,000 hours at 105°C.	Appearance NO significant damage.
		Capacitance change $\leq \pm 20\%$ of the initial value.
		DF (tan δ) $\leq 150\%$ of the initial specified value.
		ESR $\leq 150\%$ of the initial specified value.
		Leakage current \leq The initial specified value.
Damp Heag (Steady State)	The following specifications shall be satisfied when the capacitors are restored to 20°C after subjecting them to store 60°C, 90 to 95% RH for 1,000 hours, without DC applied.	Appearance NO significant damage.
		Capacitance change $\leq \pm 20\%$ of the initial value.
		DF (tan δ) $\leq 150\%$ of the initial specified value.
		ESR $\leq 150\%$ of the initial specified value.
		Leakage current \leq The initial specified value.
Surge Voltage	The capacitors shall be subjected to 1,000 cycles each consisting of charge with the surge voltages specified at 105°C for 30 seconds through aprotective resistor (R = 1 kΩ) and discharge for 5 minutes 30 seconds.	Appearance NO significant damage.
		Capacitance change $\leq \pm 20\%$ of the initial value.
		DF (tan δ) $\leq 150\%$ of the initial specified value.
		ESR $\leq 150\%$ of the initial specified value.
		Leakage current \leq The initial specified value.

※ Note : If any doubt arises, measure the leakage current after following voltage treatment.
Voltage treatmen : DC rated voltage are applied to the capacitors for 120 minutes at 105°C.

MARKING AND DIMENSIONS

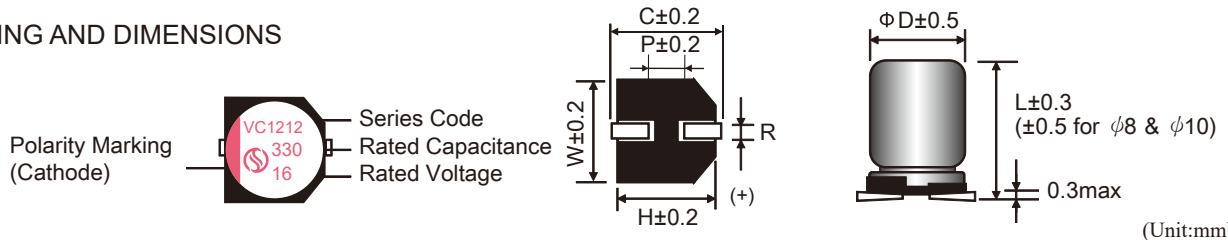

φ DxL	φ D	L	W	H	C	R	P
5x6	5.0	6.0	5.3	5.3	6.0	0.5~0.8	1.4
6.3x6	6.3	6.0	6.6	6.6	7.3	0.5~0.8	2.1
6.3x9.5	6.3	9.5	6.6	6.6	7.3	0.5~0.8	2.1
8x7	8.0	7.0	8.3	8.3	9.0	0.5~0.8	3.2
8x9.5	8.0	9.5	8.3	8.3	9.0	0.8~1.1	3.2
8x12	8.0	12.0	8.3	8.3	9.0	0.8~1.1	3.2
10x10.5	10.0	10.5	10.3	10.3	11.0	0.8~1.1	4.6
10x12.5	10.0	12.5	10.3	10.3	11.0	0.8~1.1	4.6

VC SERIES STANDARD CHARACTERISTICS LIST

Rated Voltage (S.V.)	Cap (μF)	Size DxL	Leakage current (μA) max. ※2	ESR (mΩ) max. 100k to 300kHz / 20°C	Rated Ripple Current (mA rms) 100kHz / 105°C	D.F. (tanδ) max. 120Hz / 20°C
2.5 (2.9)	220	5×6	300	40	1,620	0.12
	330	6.3×6	300	20	2,690	0.12
	820	6.3×9.5	410	18	3,200	0.12
	820	8×9.5	410	18	4,520	0.12
	1,500	8×9.5	750	18	4,520	0.12
	1,800	8×12	900	12	5,200	0.12
	2,700	10×12.5	1,350	12	5,500	0.12
4 (4.6)	68	5×6	300	40	1,500	0.12
	150	6.3×6	300	24	2,200	0.12
	680	6.3×9.5	544	16	3,200	0.12
	680	8×7	544	20	3,400	0.12
	1,000	8×9.5	800	16	4,500	0.12
	1,500	8×12	1,200	14	5,100	0.12
	1,800	10×12.5	1,440	12	5,500	0.12
	2,200	10×12.5	2,000	12	5,500	0.12
6.3 (7.2)	100	5×6	300	40	1,500	0.12
	220	5×7	300	20	1,600	0.12
	220	6.3×6	300	20	2,400	0.12
	560	6.3×9.5	705	20	3,200	0.12
	560	8×7	705	20	3,300	0.12
	820	8×9.5	1,033	15	4,450	0.12
	1,000	8×9.5	1,260	15	4,520	0.12
	1,200	8×12	1,512	12	5,020	0.12
	1,500	10×10.5	1,890	15	5,020	0.12
	1,800	10×12.5	2,268	12	5,400	0.12
	2,200	10×12.5	2,772	12	5,500	0.12
10 (11.5)	68	5×6	300	40	1,500	0.12
	120	6.3×6	300	25	2,420	0.12
	150	8×7	300	22	2,450	0.12
	330	6.3×9.5	660	20	3,200	0.12
	560	8×9.5	1,120	16	4,450	0.12
	680	8×9.5	1,360	16	4,450	0.12
	820	8×12	1,640	14	4,850	0.12
	1,000	10×10.5	2,000	15	5,020	0.12
	1,200	10×10.5	2,400	15	5,200	0.12
	1,500	10×12.5	3,000	14	5,400	0.12
16 (18.4)	100	6.3×6	320	24	2,400	0.12
	180	6.3×9.5	576	20	3,200	0.12
	220	6.3×9.5	704	20	3,200	0.12
	270	6.3×9.5	864	20	3,200	0.12
	270	8×7	864	20	3,400	0.12
	270	8×9.5	864	20	4,400	0.12
	470	8×9.5	1,504	20	4,400	0.12
	560	8×12	1,792	16	4,820	0.12
	680	10×10.5	2,176	18	5,200	0.12
	1,000	10×12.5	3,200	16	5,400	0.12

※ 1. Capacitance tolerance : ±20% (M)
 ※ 2. After 2 minutes

FREQUENCY COEFFICIENT FOR RIPPLE CURRENT

Frequency	120Hz ≤ f < 1kHz	1kHz ≤ f < 10kHz	10kHz ≤ f < 100kHz	100kHz ≤ f < 500kHz
Coefficient	0.05	0.3	0.7	1

VC

VL series

- Super low ESR, Long Life capability
- Rated voltage : 4~50V.
- Endurance : 5,000hours at 105°C
- Applications : DC/DC Converter, Voltage Regulators, Decoupling Applications for Computer Motherboards, etc.
- RoHS compliant
- Halogen Free compliant



VL

SPECIFICATIONS

Items	Conditions	Characteristics
Category Temperature Range	—	-55 to +105°C
Rated Voltage Range	—	4 ~ 50V
Capacitance Tolerance	at 20°C, 120Hz	±20%(M)
Surge Voltage	at 105°C	Rated voltage ×1.15V
Leakage Current	at 20°C after 2 minutes	$I \leq 0.2CV$ or $300(\mu A)$ Whichever is greater measured, after 2 minutes application of rated working voltage at +20°C. Please see the attached characteristics list
Dissipation Factor (tan δ)	at 20°C, 120Hz	Please see the attached characteristics list
Characteristics of Impedance at low, high temperature	at -55°C, 100kHz	$Z(-55^\circ C)/Z(+20^\circ C) \leq 1.25$
	at -25°C, 100kHz	$Z(-25^\circ C)/Z(+20^\circ C) \leq 1.15$
Endurance	The following specifications shall be satisfied when the capacitors are restored to 20°C after the rated voltage is applied for 5,000 hours at 105°C.	Appearance NO significant damage.
		Capacitance change $\leq \pm 20\%$ of the initial value.
		DF (tan δ) $\leq 150\%$ of the initial specified value.
		ESR $\leq 150\%$ of the initial specified value.
		Leakage current \leq The initial specified value.
Damp Heag (Steady State)	The following specifications shall be satisfied when the capacitors are restored to 20°C after subjecting them to store 60°C, 90 to 95% RH for 1,000 hours, without DC applied.	Appearance NO significant damage.
		Capacitance change $\leq \pm 20\%$ of the initial value.
		DF (tan δ) $\leq 150\%$ of the initial specified value.
		ESR $\leq 150\%$ of the initial specified value.
		Leakage current \leq The initial specified value.
Surge Voltage	The capacitors shall be subjected to 1,000 cycles each consisting of charge with the surge voltages specified at 105°C for 30 seconds through a protective resistor (R = 1 kΩ) and discharge for 5 minutes 30 seconds.	Appearance NO significant damage.
		Capacitance change $\leq \pm 20\%$ of the initial value.
		DF (tan δ) $\leq 150\%$ of the initial specified value.
		ESR $\leq 150\%$ of the initial specified value.
		Leakage current \leq The initial specified value.

※ Note : If any doubt arises, measure the leakage current after following voltage treatment.
Voltage treatment : DC rated voltage are applied to the capacitors for 120 minutes at 105°C.

MARKING AND DIMENSIONS

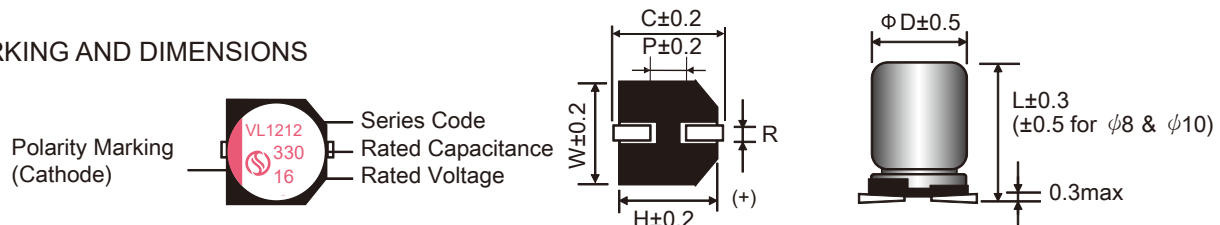

(Unit:mm)

φ DxL	φ D	L	W	H	C	R	P
6.3×6	6.3	6.0	6.6	6.6	7.3	0.5~0.8	2.1
6.3×7	6.3	7.0	6.6	6.6	7.3	0.5~0.8	2.1
6.3×9.5	6.3	9.5	6.6	6.6	7.3	0.5~0.8	2.1
8×7	8.0	7.0	8.3	8.3	9.0	0.5~0.8	3.2
8×9.5	8.0	9.5	8.3	8.3	9.0	0.8~1.1	3.2
8×12	8.0	12.0	8.3	8.3	9.0	0.8~1.1	3.2
10×10.5	10.0	10.5	10.3	10.3	11.0	0.8~1.1	4.6
10×12.5	10.0	12.5	10.3	10.3	11.0	0.8~1.1	4.6

VL SERIES STANDARD CHARACTERISTICS LIST

Rated Voltage (S.V.)	Cap (μF)	Size DxL	Leakage current (μA) max. ※2	ESR (mΩ) max. 100k to 300kHz / 20°C	Rated Ripple Current (mA rms) 100kHz / 105°C	D.F. (tanδ) max. 120Hz / 20°C
4 (4.6)	220	6.3X6	300	20	2,800	0.12
	560	6.3x9.5	448	20	3,500	0.12
	560	8x7	448	18	3,700	0.12
	820	8x9.5	656	15	4,000	0.12
	1,200	8x12	960	15	4,450	0.12
	1,500	10x10.5	1,200	13	4,500	0.12
	2,200	10x12.5	1,760	13	5,400	0.12
6.3 (7.2)	100	6.3x6	300	22	2,400	0.12
	220	6.3x6	300	22	2,600	0.12
	470	6.3x9.5	592	22	3,200	0.12
	560	6.3x9.5	705	22	3,200	0.12
	820	8x9.5	1,033	20	3,850	0.12
	1,000	8x12	1,260	20	4,250	0.12
	1,200	10x10.5	1,512	18	4,350	0.12
	1,800	10x12.5	2,268	18	5,200	0.12
10 (11.5)	68	6.3x6	300	30	2,400	0.12
	100	6.3x6	300	30	2,400	0.12
	220	6.3x7	440	30	2,500	0.12
	330	6.3x9.5	660	30	3,150	0.12
	560	8x9.5	1,120	25	3,850	0.12
	680	8x12	1,360	25	4,150	0.12
	820	10x10.5	1,640	20	4,250	0.12
	1,000	10x10.5	2,000	20	4,250	0.12
	1,200	10x12.5	2,400	20	5,100	0.12
16 (18.4)	100	6.3x6	320	30	2,200	0.12
	220	6.3x9.5	704	30	3,050	0.12
	330	8x9.5	1,056	20	3,450	0.12
	470	8x12	1,504	20	4,050	0.12
	680	10x10.5	2,176	20	4,150	0.12
	820	10x12.5	2,624	20	5,100	0.12
25 (28.8)	47	6.3x6	300	40	1,500	0.12
	100	6.3x9.5	500	35	2,800	0.12
	180	8x9.5	900	30	3,250	0.12
	220	8x12	1,100	30	3,900	0.12
	330	10x10.5	1,650	20	4,100	0.12
	470	10x12.5	2,350	25	4,500	0.12
35 (40.3)	22	6.3x6	300	70	1,450	0.12
	68	6.3x9.5	476	60	1,500	0.12
	120	8x9.5	840	50	1,800	0.12
	150	8x12	1,050	50	2,850	0.12
	220	10x10.5	1,540	40	2,950	0.12
	270	10x12.5	1,890	40	3,200	0.12
50 (57.5)	10	6.3x6	300	60	1,400	0.12
	33	6.3x9.5	330	30	1,700	0.12
	47	8x9.5	470	30	2,000	0.12
	68	8x12	680	28	2,200	0.12
	100	10x10.5	1,000	30	2,300	0.12
	100	10x12.5	1,000	26	2,650	0.12

※ 1. Capacitance tolerance : ±20% (M)
 ※ 2. After 2 minutes

FREQUENCY COEFFICIENT FOR RIPPLE CURRENT

Frequency	120Hz ≤ f < 1kHz	1kHz ≤ f < 10kHz	10kHz ≤ f < 100kHz	100kHz ≤ f < 500kHz
Coefficient	0.05	0.3	0.7	1

VL

VH series

- Low ESR, High Voltage, High ripple current capability
- Rated voltage : 35~100V.
- Endurance : 2,000hours at 105°C
- Applications : LED Driver, LED Power Supply, etc.
- RoHS compliant
- Halogen Free compliant



VH

SPECIFICATIONS

Items	Conditions	Characteristics
Category Temperature Range	—	-55 to +105°C
Rated Voltage Range	—	35 ~ 100V
Capacitance Tolerance	at 20°C, 120Hz	±20%(M)
Surge Voltage	at 105°C	Rated voltage ×1.15V
Leakage Current	at 20°C after 2 minutes	$I \leq 0.2CV$ or $300(\mu A)$ Whichever is greater measured, after 2 minutes application of rated working voltage at +20°C. Please see the attached characteristics list
Dissipation Factor (tan δ)	at 20°C, 120Hz	Please see the attached characteristics list
Characteristics of Impedance at low, high temperature	at -55°C, 100kHz	$Z(-55^\circ C)/Z(+20^\circ C) \leq 1.25$
	at -25°C, 100kHz	$Z(-25^\circ C)/Z(+20^\circ C) \leq 1.15$
Endurance	The following specifications shall be satisfied when the capacitors are restored to 20°C after the rated voltage is applied for 2,000 hours at 105°C.	Appearance NO significant damage.
		Capacitance change $\leq \pm 20\%$ of the initial value.
		DF (tan δ) $\leq 150\%$ of the initial specified value.
		ESR $\leq 150\%$ of the initial specified value.
		Leakage current \leq The initial specified value.
Damp Heag (Steady State)	The following specifications shall be satisfied when the capacitors are restored to 20°C after subjecting them to store at 60°C, 90 to 95% RH for 1,000 hours, without DC applied.	Appearance NO significant damage.
		Capacitance change $\leq \pm 20\%$ of the initial value.
		DF (tan δ) $\leq 150\%$ of the initial specified value.
		ESR $\leq 150\%$ of the initial specified value.
		Leakage current \leq The initial specified value.
Surge Voltage	The capacitors shall be subjected to 1,000 cycles each consisting of charge with the surge voltages specified at 105°C for 30 seconds through a protective resistor (R = 1 kΩ) and discharge for 5 minutes 30 seconds.	Appearance NO significant damage.
		Capacitance change $\leq \pm 20\%$ of the initial value.
		DF (tan δ) $\leq 150\%$ of the initial specified value.
		ESR $\leq 150\%$ of the initial specified value.
		Leakage current \leq The initial specified value.

※ Note : If any doubt arises, measure the leakage current after following voltage treatment.
Voltage treatment : DC rated voltage are applied to the capacitors for 120 minutes at 105°C.

MARKING AND DIMENSIONS

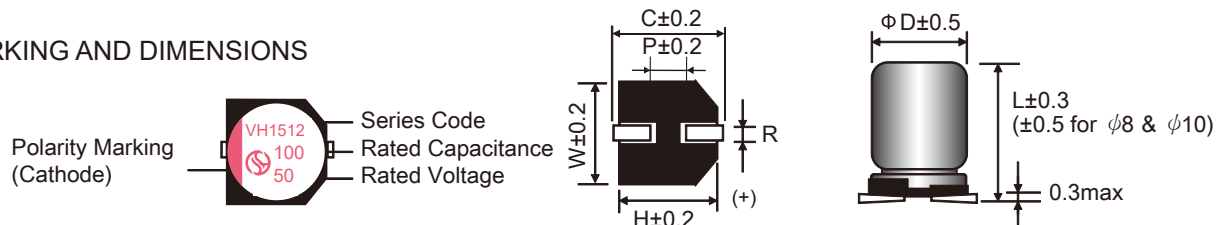

(Unit:mm)

φ DxL	φ D	L	W	H	C	R	P
6.3x6	6.3	6.0	6.6	6.6	7.3	0.5~0.8	2.1
6.3x9.5	6.3	9.5	6.6	6.6	7.3	0.5~0.8	2.1
8x7	8.0	7.0	8.3	8.3	9.0	0.5~0.8	3.2
8x9.5	8.0	9.5	8.3	8.3	9.0	0.8~1.1	3.2
8x12	8.0	12.0	8.3	8.3	9.0	0.8~1.1	3.2
10x10.5	10.0	10.5	10.3	10.3	11.0	0.8~1.1	4.6
10x12.5	10.0	12.5	10.3	10.3	11.0	0.8~1.1	4.6

VH SERIES STANDARD CHARACTERISITICS LIST

Rated Voltage (S.V.)	Cap (μF)	Size DxL	Leakage current (μA) max. ※2	ESR (mΩ) max. 100k to 300kHz / 20°C	Rated Ripple Current (mA rms) 100kHz / 105°C	D.F. (tanδ) max. 120Hz / 20°C
35 (40.3)	22	6.3x6	300	80	1,450	0.12
	56	6.3x9.5	392	50	2,300	0.12
	68	6.3x9.5	476	50	2,300	0.12
	68	8x7	476	60	2,500	0.12
	100	8x12	700	28	2,750	0.12
	220	10x12.5	1,540	28	3,200	0.12
50 (57.5)	12	6.3x6	300	100	1,450	0.12
	33	6.3x9.5	330	50	1,800	0.12
	47	8x9.5	470	45	2,100	0.12
	100	10x12.5	1,000	28	2,560	0.12
	180	10x12.5	1,800	28	2,750	0.12
63 (72.5)	22	6.3x9.5	300	50	1,800	0.12
	33	6.3x9.5	416	50	1,800	0.12
	47	8x12	592	36	2,200	0.12
	56	10x10.5	705	32	2,350	0.12
	100	10x12.5	1,260	28	2,550	0.12
	150	10x12.5	1,890	28	2,550	0.12
80 (92.0)	22	8x9.5	352	45	2,100	0.12
	33	8x12	528	45	2,100	0.12
	47	10x10.5	752	45	2,250	0.12
	68	10x12.5	1,088	38	2,550	0.12
100 (115.0)	15	8x12	300	40	2,050	0.12
	22	10x12.5	440	38	2,250	0.12
	27	10x12.5	540	38	2,250	0.12

- ※ 1. Capacitance tolerance : ±20% (M)
- ※ 2. After 2 minutes

FREQUENCY COEFFICIENT FOR RIPPLE CURRENT

Frequency	120Hz ≤ f < 1kHz	1kHz ≤ f < 10kHz	10kHz ≤ f < 100kHz	100kHz ≤ f < 500kHz
Coefficient	0.05	0.3	0.7	1

VH

VT series

- Super low ESR, High ripple current capability
- Rated voltage : 4~50V.
- Endurance : 1,000hours at 125°C
- Applications : Motherboard, DC/DC Converter, Adapter, SPS, VCR, Camcorder, DSC, PDA, HD Drive, MO Drive, etc.
- RoHS compliant
- Halogen Free compliant



VT

SPECIFICATIONS

Items	Conditions	Characteristics
Category Temperature Range	—	-55 to +125°C
Rated Voltage Range	—	4 ~ 50V
Capacitance Tolerance	at 20°C, 120Hz	±20%(M)
Surge Voltage	at 105°C	Rated voltage ×1.15V
Leakage Current	at 20°C after 2 minutes	$I \leq 0.2CV$ or $300(\mu A)$ Whichever is greater measured, after 2 minutes application of rated working voltage at +20°C. Please see the attached characteristics list
Dissipation Factor (tan δ)	at 20°C, 120Hz	Please see the attached characteristics list
Characteristics of Impedance at low, high temperature	at -55°C, 100kHz	$Z(-55^\circ C)/Z(+20^\circ C) \leq 1.25$
	at -25°C, 100kHz	$Z(-25^\circ C)/Z(+20^\circ C) \leq 1.15$
Endurance	The following specifications shall be satisfied when the capacitors are restored to 20°C after the rated voltage is applied for 1,000 hours at 125°C.	Appearance NO significant damage.
		Capacitance change $\leq \pm 20\%$ of the initial value.
		DF (tan δ) $\leq 150\%$ of the initial specified value.
		ESR $\leq 150\%$ of the initial specified value.
		Leakage current \leq The initial specified value.
Damp Heag (Steady State)	The following specifications shall be satisfied when the capacitors are restored to 20°C after subjecting them to store 60°C, 90 to 95% RH for 1,000 hours, without DC applied.	Appearance NO significant damage.
		Capacitance change $\leq \pm 20\%$ of the initial value.
		DF (tan δ) $\leq 150\%$ of the initial specified value.
		ESR $\leq 150\%$ of the initial specified value.
		Leakage current \leq The initial specified value.
Surge Voltage	The capacitors shall be subjected to 1,000 cycles each consisting of charge with the surge voltages specified at 105°C for 30 seconds through a protective resistor (R = 1 kΩ) and discharge for 5 minutes 30 seconds.	Appearance NO significant damage.
		Capacitance change $\leq \pm 20\%$ of the initial value.
		DF (tan δ) $\leq 150\%$ of the initial specified value.
		ESR $\leq 150\%$ of the initial specified value.
		Leakage current \leq The initial specified value.

※ Note : If any doubt arises, measure the leakage current after following voltage treatment.
Voltage treatment : DC rated voltage are applied to the capacitors for 120 minutes at 125°C.

MARKING AND DIMENSIONS

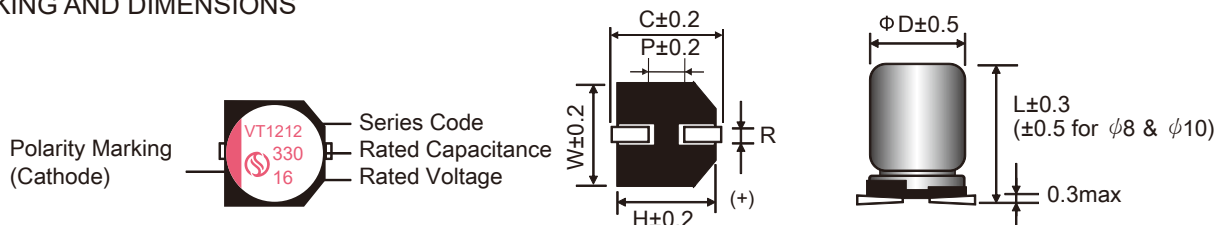

φ DxL	φ D	L	W	H	C	R	P
6.3×6	6.3	6.0	6.6	6.6	7.3	0.5~0.8	2.1
6.3×7	6.3	7.0	6.6	6.6	7.3	0.5~0.8	2.1
6.3×9.5	6.3	9.5	6.6	6.6	7.3	0.5~0.8	2.1
8×7	8.0	7.0	8.3	8.3	9.0	0.5~0.8	3.2
8×9.5	8.0	9.5	8.3	8.3	9.0	0.8~1.1	3.2
8×12	8.0	12.0	8.3	8.3	9.0	0.8~1.1	3.2
10×10.5	10.0	10.5	10.3	10.3	11.0	0.8~1.1	4.6
10×12.5	10.0	12.5	10.3	10.3	11.0	0.8~1.1	4.6

(Unit:mm)

VT SERIES STANDARD CHARACTERISITICS LIST

Rated Voltage (S.V.)	Cap (μF)	Size DxL	Leakage current (μA) max. ※2	ESR (mΩ) max. 100k to 300kHz / 20°C	Rated Ripple Current (mA rms)		D.F. (tanδ) max. 120Hz / 20°C
					105°C 100kHz	125°C 100kHz	
4 (4.6)	150	6.3x6	300	35	2,450	700	0.12
	220	6.3x6	300	20	2,800	800	0.12
	560	6.3x9.5	448	20	3,000	857	0.12
	560	8x7	448	20	3,000	857	0.12
	820	8x9.5	656	15	3,500	1,000	0.12
	1,200	8x12	960	15	3,800	1,086	0.12
	1,500	10x10.5	1,200	12	4,500	1,286	0.12
	2,200	10x12.5	1,760	12	5,500	1,571	0.12
6.3 (7.2)	100	6.3x6	300	40	2,400	686	0.12
	150	6.3x6	300	40	2,400	686	0.12
	330	6.3x7	415	30	2,800	800	0.12
	470	6.3x9.5	592	25	2,800	800	0.12
	680	8x9.5	856	25	2,800	800	0.12
	820	8x12	1,033	20	3,000	857	0.12
	1,000	8x12	1,260	20	3,000	857	0.12
	1,200	10x10.5	1,512	20	3,000	857	0.12
	1,800	10x12.5	2,268	18	3,000	857	0.12
10 (11.5)	100	6.3x6	300	35	2,800	800	0.12
	330	6.3x9.5	660	25	2,800	800	0.12
	470	8x9.5	940	25	3,000	857	0.12
	560	8x9.5	1,120	25	3,000	857	0.12
	680	8x12	1,360	20	3,500	1,000	0.12
	820	10x10.5	1,640	20	3,500	1,000	0.12
	1,000	10x10.5	2,000	20	3,500	1,000	0.12
	1,200	10x12.5	2,400	12	5,200	1,486	0.12
16 (18.4)	100	6.3x6	320	35	2,050	586	0.12
	220	6.3x9.5	704	25	2,050	586	0.12
	330	8x9.5	1,056	25	2,700	771	0.12
	470	8x12	1,504	20	3,930	1,123	0.12
	680	10x10.5	2,176	18	4,520	1,291	0.12
	820	10x12.5	2,624	18	4,900	1,400	0.12
25 (28.8)	47	6.3x6	300	60	1,650	471	0.12
	100	6.3x9.5	500	30	1,650	471	0.12
	220	8x12	1,100	28	3,310	946	0.12
	330	10x10.5	1,650	30	4,320	1,234	0.12
	470	10x12.5	2,350	28	4,500	1,286	0.12
35 (40.3)	22	6.3x6	300	70	1,450	414	0.12
	68	6.3x9.5	476	40	1,450	414	0.12
	120	8x9.5	840	40	1,800	514	0.12
	150	8x12	1,050	30	2,000	571	0.12
	220	10x10.5	1,540	30	2,200	629	0.12
	270	10x12.5	1,890	30	2,500	714	0.12

VT

VT SERIES STANDARD CHARACTERISITICS LIST

Rated Voltage (S.V.)	Cap (μF)	Size DxL	Leakage current (μA) max. ※2	ESR (mΩ) max. 100k to 300kHz / 20°C	Rated Ripple Current (mA rms)		D.F. (tanδ) max. 120Hz / 20°C
					105°C 100kHz	125°C 100kHz	
50 (57.5)	10	6.3x6	300	60	1,400	400	0.12
	33	6.3x9.5	330	40	1,500	429	0.12
	47	8x9.5	470	40	2,000	571	0.12
	68	8x12	680	35	2,300	657	0.12
	100	10x10.5	1,000	35	2,200	629	0.12
	100	10x12.5	1,000	35	2,500	714	0.12

※ 1. Capacitance tolerance : ±20% (M)

※ 2. After 2 minutes

FREQUENCY COEFFICIENT FOR RIPPLE CURRENT

Frequency	120Hz ≤ f < 1kHz	1kHz ≤ f < 10kHz	10kHz ≤ f < 100kHz	100kHz ≤ f < 500kHz
Coefficient	0.05	0.3	0.7	1

VT

VP series

- High temperature Low ESR,High ripple current capability
- Rated voltage : 6.3~35V
- Endurance : 2,000 hours at 125°C
- Applications : Lamps Power,LED Driver,Serving Equipment.
- RoHS compliance
- Halogen Free compliant



SPECIFICATIONS

Items	Conditions	Characteristics
Category Temperature Range	—	-55 to +125°C
Rated Voltage Range	—	6.3 ~ 35V
Capacitance Tolerance	at 20°C,120Hz	±20%(M)
Surge Voltage	at 125°C	Rated voltage ×1.15V
Leakage Current	at 20°C after 2 minutes	$I \leq 0.2CV$ or $300(\mu A)$ Whichever is greater measured,after 2minutes application of rated working voltage at +20°C. Please see the attached characteristics list
Dissipation Factor (tan δ)	at 20°C,120Hz	Please see the attached characteristics list
Characteristics of Impedance at low, high temperature	at -55°C,100kHz	$Z(-55^{\circ}C)/Z(+20^{\circ}C) \leq 1.25$
	at -25°C,100kHz	$Z(-25^{\circ}C)/Z(+20^{\circ}C) \leq 1.15$
Endurance	The following specifications shall be satisfied when the capacitors are restored to 20°C after the rated voltage is applied for 2,000 hours at 125°C.	Appearance NO significant damage.
		Capacitance change $\leq \pm 20\%$ of the initial value.
		DF (tan δ) $\leq 150\%$ of the initial specified value.
		ESR $\leq 150\%$ of the initial specified value.
		Leakage current \leq The initial specified value.
Damp Heag (Steady State)	The following specifications shall be satisfied when the capacitors are restored to 20°C after subjecting them to store at 60°C, 90 to 95% RH for 1,000 hours ,without DC applied.	Appearance NO significant damage.
		Capacitance change $\leq \pm 20\%$ of the initial value.
		DF (tan δ) $\leq 150\%$ of the initial specified value.
		ESR $\leq 150\%$ of the initial specified value.
		Leakage current \leq The initial specified value.
Surge Voltage	The capacitors shall be subjected to 1,000 cycles each consisting of charge with the surge voltages specified at 105°C for 30 seconds through aprotective resistor (R=1kΩ) and discharge for 5 minutes 30 seconds.	Appearance NO significant damage.
		Capacitance change $\leq \pm 20\%$ of the initial value.
		DF (tan δ) $\leq 150\%$ of the initial specified value.
		ESR $\leq 150\%$ of the initial specified value.
		Leakage current \leq The initial specified value.

※ Note:If any doubt arises,measure the leakage current after following voltage treatment.
Voltage treatment :DC rated voltage are applied to the capacitors for 120 minutes at 125°C.

MARKING AND DIMENSIONS

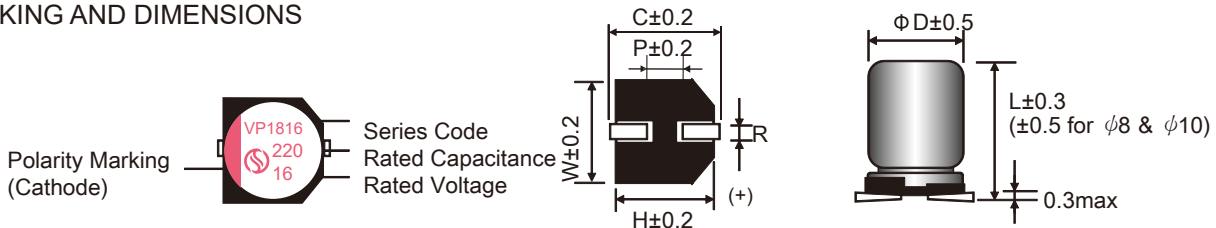

(Unit:mm)

φ D×L	φ D	L	W	H	C	R	P
6.3×9.5	6.3	9.5	6.6	6.3	7.3	0.5~0.8	2.1
8×9.5	8.0	9.5	8.3	8.3	9.0	0.8~1.1	3.2
8×12	8.0	12.0	8.3	8.3	9.0	0.8~1.1	3.2
10×10.5	10.0	10.5	10.3	10.3	11.0	0.8~1.1	4.6
10×12.5	10.0	12.5	10.3	10.3	11.0	0.8~1.1	4.6

VP

VP SERIES STANDARD CHARACTERISTICS LIST

Rated Voltage (S.V.)	Cap (μF)	Size DxL	Leakage current (μA) max. ※2	ESR (mΩ) max. 100k to 300kHz / 20°C	Rated Ripple Current (mA rms/100kHz)		D.F. (tanδ) max. 120Hz / 20°C
					-55°C ≤ 環境溫度 ≤ 105°C	105°C ≤ 環境溫度 ≤ 125°C	
6.3 (7.2)	470	6.3x9.5	592	25	3,800	1,267	0.12
	680	8x9.5	857	25	4,000	1,333	0.12
	1000	8x12	1,260	20	4,200	1,400	0.12
	1200	10x10.5	1,512	25	5,500	1,833	0.12
	1800	10x12.5	2,268	20	6,100	2,033	0.12
10 (11.5)	330	6.3x9.5	660	25	3,700	1,233	0.12
	560	8x9.5	1,120	25	4,000	1,333	0.12
	680	8x12	1,360	20	4,500	1,500	0.12
	820	10x10.5	1,640	25	4,200	1,400	0.12
	1000	10x10.5	2,000	25	4,500	1,500	0.12
	1200	10x12.5	2,400	20	5,600	1,867	0.12
16 (18.4)	220	6.3x9.5	704	25	2,850	950	0.12
	330	8x9.5	1,056	25	4,000	1,333	0.12
	470	8x12	1,504	20	4,500	1,500	0.12
	680	10x10.5	2,176	25	5,100	1,700	0.12
	820	10x12.5	2,624	20	5,600	1,867	0.12
20 (23.0)	120	6.3x9.5	480	25	2,510	837	0.12
	220	8x9.5	880	25	2,750	917	0.12
	270	8x12	1,080	20	2,950	983	0.12
	330	10x10.5	1,320	25	4,700	1,567	0.12
	470	10x12.5	1,880	20	4,950	1,650	0.12
25 (28.8)	100	6.3x9.5	500	40	2,380	793	0.12
	180	8x9.5	900	30	2,900	967	0.12
	220	8x9.5	1,100	28	3,500	1,167	0.12
	330	10x10.5	1,650	30	4,250	1,417	0.12
	470	10x12.5	2,350	28	4,500	1,500	0.12
35 (40.3)	56	6.3x9.5	392	60	2,300	767	0.12
	100	8x9.5	700	50	2,500	833	0.12
	120	8x12	840	30	2,950	983	0.12
	150	10x10.5	1,050	30	2,950	983	0.12
	220	10x12.5	1,540	28	3,400	1,133	0.12

※ 1. Capacitance tolerance : ±20% (M)

※ 2. After 2 minutes

FREQUENCY COEFFICIENT FOR RIPPLE CURRENT

Frequency	120Hz ≤ f < 1kHz	1kHz ≤ f < 10kHz	10kHz ≤ f < 100kHz	100kHz ≤ f < 500kHz
Coefficient	0.05	0.3	0.7	1

PV series

- Super low ESR, High ripple current capability
- Rated voltage :2.5~63V.
- Endurance:15,000hours at 105°C
- Applications:motherboards, servers,VGA ,etc.
- ROHS compliant
- Halogen Free compliant



SPECIFICATIONS

Items	Conditions	Characteristics
Category Temperature Range	—	-55 to +105°C
Rated Voltage Range	—	2.5~63V
Capacitance Tolerance	at 20°C,120HZ	±20%(M)
Surge Voltage	at 105°C	Rated voltage ×1.15V
Leakage Current	at 20°Cafter 2 minutes	I≤0.2CV or 300(μA) Whichever is greater measured,after 2minutes application of rated working voltage at +20°C.
Dissipation Factor (tan δ)	at 20°C,120Hz	Please see the attached characteristics list
Characteristics of Impedance at low, high temperature	at -55°C,100kHz	Z(-55°C)/Z(+20°C) ≤ 1.25
	at -25°C,100kHz	Z(-25°C)/Z(+20°C) ≤ 1.15
Endurance	The following specifications shall be satisfied when the capacitors are restored to 20°Cafter the rated voltage is applied for 15,000 hours at 105°C.	Appearance NO significant damage.
		Capacitance change ≤±20% of the initial value.
		DF(tanδ) ≤150% of the initial specified value.
		ESR ≤150% of the initial specified value.
		Leakage current ≤The initial specified value.
Damp Heag (Steady State)	The following specifications shall be satisfied when the capacitors are restored to 20°C after subjecting them to subjecting them to store at 60°C, 90 to 95% RH for 1,000 hours ,without DC applied.	Appearance NO significant damage.
		Capacitance change ≤±20% of the initial value.
		DF(tanδ) ≤150% of the initial specified value.
		ESR ≤150% of the initial specified value.
		Leakage current ≤The initial specified value.
Surge Voltage	The capacitors shall be subjected to 1,000 cycles each consisting of charge with the surge voltages specified at 105°C for 30 seconds through aprotective resistor (R=1kΩ) and discharge for 5 minutes 30seconds	Appearance NO significant damage.
		Capacitance change ≤±20% of the initial value.
		DF(tanδ) ≤150% of the initial specified value.
		ESR ≤150% of the initial specified value.
		Leakage current ≤The initial specified value.

※ Note:If any doubt arises,measure the leakage current after following voltage treatment.
Voltage treatment :DC rated voltage are applied to the capacitors for 120 minutes at 105°C.

MARKING AND DIMENSIONS

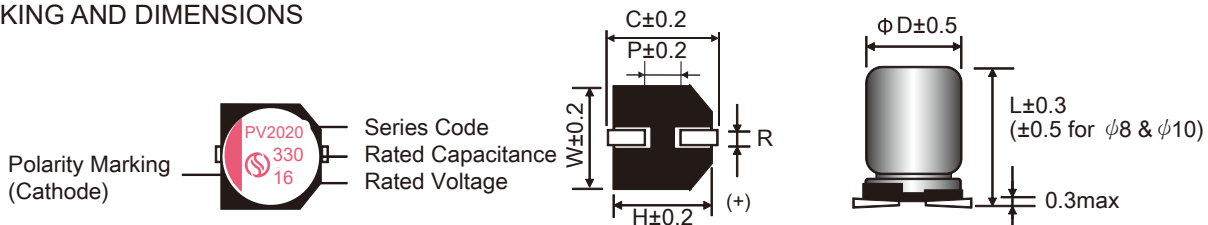

(Unit:mm)

Size Code	φ D	L	W	H	C	R	P
5×6	5.0	6.0	5.3	5.3	6.0	0.5~0.8	1.4
6.3×6	6.3	6.0	6.6	6.6	7.3	0.5~0.8	2.1
6.3×9.5	6.3	9.5	6.6	6.6	7.3	0.5~0.8	2.1
8×7	8.0	7.0	8.3	8.3	9.3	0.5~0.8	3.2
8×9.5	8.0	9.5	8.3	8.3	9.3	0.8~1.1	3.2
8×12	8.0	12.0	8.3	8.3	9.0	0.8~1.1	3.2
10×8	10.0	8.0	10.3	10.3	11.0	0.8~1.1	4.6
10×10.5	10.0	10.5	10.3	10.3	11.0	0.8~1.1	4.6
10×12.5	10.0	12.5	10.3	10.3	11.0	0.8~1.1	4.6

PV

PV SERIES STANDARD CHARACTERISTICS LIST

Rated Voltage (S.V.)	Cap (μF)	Size DxL	Leakage current (μA) max. ※2	ESR (mΩ) max. 100k to 300kHz / 20°C	Rated Ripple Current (mA rms) 100kHz / 105°C	D.F. (tanδ) max. 120Hz / 20°C
2.5 (2.9)	220	5×6	300	40	1,620	0.12
	330	6.3×6	300	20	2,690	0.12
	820	6.3×9.5	410	18	3200	0.12
	820	8×9.5	410	18	4520	0.12
	1500	8×9.5	750	18	4520	0.12
	1800	8×12	900	12	5200	0.12
	2700	10×12.5	1,350	12	5,500	0.12
4 (4.6)	68	5×6	300	40	1,500	0.12
	150	6.3×6	300	24	2,200	0.12
	680	6.3×9.5	544	16	3,200	0.12
	680	8×7	544	20	3,400	0.12
	1000	8×9.5	800	16	4,500	0.12
	1500	8×12	1,200	14	5,100	0.12
	1800	10×12.5	1,440	12	5,500	0.12
6.3 (7.2)	2200	10×12.5	2,000	12	5,500	0.12
	100	5×6	300	40	1500	0.12
	220	5×7	300	20	1600	0.12
	220	6.3×6	300	20	2400	0.12
	560	6.3×9.5	705	20	3200	0.12
	560	8×7	705	20	3300	0.12
	820	8×9.5	1,033	15	4450	0.12
	1000	8×9.5	1,260	15	4520	0.12
	1200	8×12	1,512	12	5020	0.12
	1500	10×10.5	1,890	15	5020	0.12
10 (11.5)	1800	10×12.5	2,268	12	5400	0.12
	2200	10×12.5	2,772	12	5,500	0.12
	68	5×6	300	40	1,500	0.12
	120	6.3×6	300	25	2,420	0.12
	150	8×7	300	22	2,450	0.12
	330	6.3×9.5	660	20	3,200	0.12
	560	8×9.5	1,120	16	4,450	0.12
	680	8×9.5	1,360	16	4,450	0.12
	820	8×12	1,640	14	4,850	0.12
	1000	10×10.5	2,000	15	5,020	0.12
16 (18.4)	1200	10×10.5	2,400	15	5,200	0.12
	1500	10×12.5	3,000	14	5,400	0.12
	100	6.3×6	320	24	2,400	0.12
	180	6.3×9.5	576	15	3,200	0.12
	220	6.3×9.5	704	15	3,200	0.12
	270	6.3×9.5	864	15	3,200	0.12
	270	8×7	864	20	3,400	0.12
	270	8×9.5	864	20	4,400	0.12
	470	8×9.5	1,504	25	4,400	0.12
	560	8×12	1,792	16	4,820	0.12
16 (18.4)	680	10×10.5	2,176	18	5,200	0.12
	1000	10×12.5	3,200	16	5,400	0.12

※ 1. Capacitance tolerance : ±20%(M)
 ※ 2. After 2 minutes

PV SERIES STANDARD CHARACTERISITICS LIST

Rated Voltage (S.V.)	Cap (μF)	Size DxL	Leakage current (μA) max. ※2	ESR (mΩ) max. 100k to 300kHz / 20°C	Rated Ripple Current (mA rms) 100kHz / 105°C	D.F. (tanδ) max. 120Hz / 20°C
20 (23.0)	68	6.3×6	300	38	1,450	0.12
	180	6.3×9.5	720	30	1,450	0.12
	330	8×9.5	1320	30	1,890	0.12
	470	8×12	1880	28	3,320	0.12
	560	10×10.5	2240	28	3,320	0.12
	680	10×12.5	2720	28	4,220	0.12
25 (28.8)	47	6.3×6	300	40	1,200	0.12
	100	6.3×9.5	500	30	2,000	0.12
	100	8×7	500	40	2,000	0.12
	150	8×9.5	750	35	3,000	0.12
	220	8×12	1100	32	3,500	0.12
	330	10×10.5	1650	35	3,800	0.12
35 (40.3)	22	6.3×6	300	80	1,450	0.12
	56	6.3×9.5	392	50	2,300	0.12
	68	6.3×9.5	476	50	2,300	0.12
	68	8×7	476	60	2,500	0.12
	100	8×12	700	28	2,750	0.12
	220	10×12.5	1,540	28	3,200	0.12
50 (57.5)	12	6.3×6	300	100	660	0.12
	33	6.3×9.5	330	50	900	0.12
	47	8×9.5	470	45	1,850	0.12
	100	10×12.5	1,000	28	2,560	0.12
	180	10×12.5	1,800	28	2,560	0.12
63 (72.5)	22	6.3×9.5	300	50	1,800	0.12
	33	6.3×9.5	416	50	1,800	0.12
	47	8×12	592	36	2,200	0.12
	56	10×10.5	705	32	2,350	0.12
	100	10×12.5	1,260	28	2,550	0.12
	150	10×12.5	1,890	28	2,550	0.12

※ 1. Capacitance tolerance : ±20%(M)
 ※ 2. After 2 minutes

FREQUENCY COEFFICIENT FOR RIPPLE CURRENT

Frequency	120Hz ≤ f < 1kHz	1kHz ≤ f < 10kHz	10kHz ≤ f < 100kHz	100kHz ≤ f < 500kHz
Coefficient	0.05	0.3	0.7	1

PV

PH series

- Super low ESR, Long Life capability
- Rated voltage :4.0~50V.
- Endurance:20,000hours at 105°C
- Applications:DC/DC Converter, Voltage Regulators, Decoupling Applications for Computer Motherboards, etc.
- ROHS compliant
- Halogen Free compliant



PH

SPECIFICATIONS

Items	Conditions	Characteristics	
Category Temperature Range	—	-55 to +105°C	
Rated Voltage Range	—	4.0~50V	
Capacitance Tolerance	at 20°C, 120HZ	±20%(M)	
Surge Voltage	at 105°C	Rated voltage ×1.15V	
Leakage Current	at 20°C after 2 minutes	I ≤ 0.2CV or 300(μA) Whichever is greater measured, after 2 minutes application of rated working voltage at +20°C.	
Dissipation Factor (tan δ)	at 20°C, 120Hz	Please see the attached characteristics list	
Characteristics of Impedance at low, high temperature	at -55°C, 100kHz	Z(-55°C)/Z(+20°C) ≤ 1.25	
	at -25°C, 100kHz	Z(-25°C)/Z(+20°C) ≤ 1.15	
Endurance	The following specifications shall be satisfied when the capacitors are restored to 20°C after the rated voltage is applied for 20,000 hours at 105°C.	Appearance	NO significant damage.
		Capacitance change	±20% of the initial value.
		DF(tanδ)	≤150% of the initial specified value.
		ESR	≤150% of the initial specified value.
		Leakage current	≤The initial specified value.
Damp Heat (Steady State)	The following specifications shall be satisfied when the capacitors are restored to 20°C after subjecting them to store at 60°C, 90 to 95% RH for 1,000 hours, without DC applied.	Appearance	NO significant damage.
		Capacitance change	±20% of the initial value.
		DF(tanδ)	≤150% of the initial specified value.
		ESR	≤150% of the initial specified value.
		Leakage current	≤The initial specified value.
Surge Voltage	The capacitors shall be subjected to 1,000 cycles each consisting of charge with the surge voltages specified at 105°C for 30 seconds through a protective resistor (R=1kΩ) and discharge for 5 minutes 30seconds	Appearance	NO significant damage.
		Capacitance change	±20% of the initial value.
		DF(tanδ)	≤150% of the initial specified value.
		ESR	≤150% of the initial specified value.
		Leakage current	≤The initial specified value.

※ Note: If any doubt arises, measure the leakage current after following voltage treatment.
Voltage treatment :DC rated voltage are applied to the capacitors for 120 minutes at 105°C.

MARKING AND DIMENSIONS

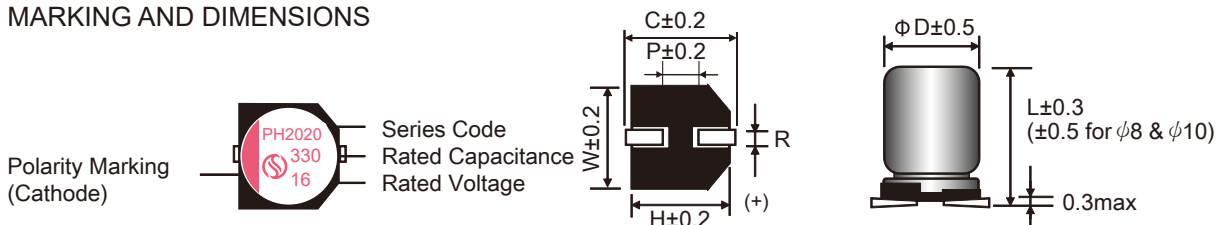

(Unit:mm)

Size Code	φD	L	W	H	C	R	P
6.3×6	6.3	6.0	6.6	6.6	7.3	0.5~0.8	2.1
6.3×7	6.3	7.0	6.6	6.6	7.3	0.5~0.8	2.1
6.3×9.5	6.3	9.5	6.6	6.6	7.3	0.5~0.8	2.1
8×7	8.0	7.0	8.3	8.3	9.3	0.5~0.8	3.2
8×9.5	8.0	9.5	8.3	8.3	9.3	0.8~1.1	3.2
8×12	8.0	12.0	8.3	8.3	9.0	0.8~1.1	3.2
10×10.5	10.0	10.5	10.3	10.3	11.0	0.8~1.1	4.6
10×12.5	10.0	12.5	10.3	10.3	11.0	0.8~1.1	4.6

PH SERIES STANDARD CHARACTERISTICS LIST

Rated Voltage (S.V.)	Cap (μF)	Size DxL	Leakage current (μA) max. ※2	ESR (mΩ) max. 100k to 300kHz / 20°C	Rated Ripple Current (mA rms) 100kHz / 105°C	D.F. (tanδ) max. 120Hz / 20°C
4 (4.6)	220	6.3X6	300	20	2,800	0.12
	560	6.3X9.5	448	20	3,500	0.12
	560	8X7	448	18	3,700	0.12
	820	8X9.5	656	15	3,500	0.12
	1200	8X12	960	15	4,450	0.12
	1500	10×10.5	1,200	13	4,200	0.12
	2200	10X12.5	1,760	13	5,400	0.12
6.3 (7.2)	100	6.3X6	300	35	2,400	0.12
	220	6.3X6	300	22	2,600	0.12
	470	6.3X9.5	592	22	3,200	0.12
	560	6.3X9.5	705	22	3,200	0.12
	820	8X9.5	1,033	20	3,850	0.12
	1000	8X12	1,260	20	4,250	0.12
	1200	10×10.5	1,512	18	4,350	0.12
	1800	10X12.5	2,268	18	5,200	0.12
10 (11.5)	68	6.3X6	300	30	2,400	0.12
	100	6.3X6	300	30	2,400	0.12
	220	6.3X7	440	30	2,500	0.12
	330	6.3X9.5	660	30	3,150	0.12
	560	8X9.5	1,120	25	3,850	0.12
	680	8x12	1,360	25	4,150	0.12
	820	10×10.5	1,640	20	4,250	0.12
	1000	10×10.5	2,000	20	4,250	0.12
	1200	10x12.5	2,400	20	5,100	0.12
16 (18.4)	100	6.3X6	320	30	2,200	0.12
	220	6.3X9.5	704	30	3,050	0.12
	330	8X9.5	1,056	20	3,450	0.12
	470	8x12	1,504	22	4,050	0.12
	680	10×10.5	2,176	20	4,150	0.12
	820	10x12.5	2,624	20	5,100	0.12
25 (28.8)	47	6.3×6	300	40	1,500	0.12
	100	6.3×9.5	500	40	2,800	0.12
	180	8×9.5	900	30	3,250	0.12
	220	8×12	1100	30	3,900	0.12
	330	10×10.5	1650	20	4,100	0.12
	470	10×12.5	2350	25	4,500	0.12
35 (40.3)	22	6.3×6	300	70	1,450	0.12
	68	6.3×9.5	476	60	1,500	0.12
	120	8×9.5	840	50	1,800	0.12
	150	8×12	1050	50	2,850	0.12
	220	10×10.5	1540	40	2,950	0.12
	270	10×12.5	1890	40	3,200	0.12
50 (57.5)	10	6.3×6	300	60	1,400	0.12
	33	6.3×9.5	330	30	1,700	0.12
	47	8×9.5	470	30	2,000	0.12
	68	8×12	680	28	2,200	0.12
	100	10×10.5	1000	30	2,300	0.12
	100	10×12.5	1000	28	2,650	0.12

※ 1. Capacitance tolerance : ±20%(M)
 ※ 2. After 2 minutes

FREQUENCY COEFFICIENT FOR RIPPLE CURRENT

Frequency	120Hz ≤ f < 1kHz	1kHz ≤ f < 10kHz	10kHz ≤ f < 100kHz	100kHz ≤ f < 500kHz
Coefficient	0.05	0.3	0.7	1

PH

Packing specifications(Lead type)

ϕ DxL	Bags / Inner Box	Layer Quantity	Quantity (pcs/bag)	Total Quantity (pcs/carton)	Size of Inner Box	Size of Out Box (L)x(W)x(H)
5x6	15	2	1000	30,000	267 X 260 X 135	546 X 279 X 160
6.3x6	10	2	1000	20,000		
6.3x (7 ~ 12)	9	2	1000	18,000		
8x (7 ~ 12)	10	2	500	10,000		
10x (8 ~ 12)	11	2	200	4,400		
10x (16 ~ 20)	9	2	200	3,600		

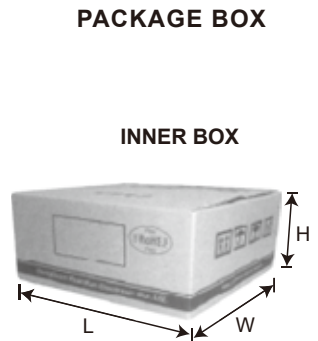

Inner Box Size:
(L) X (W) X (H)

TAPING PACKAGE

Item	Taping packing						Size of Out Box (L)x(W)x(H)
ϕ D (mm)	W \pm 5 (mm)	L \pm 5 (mm)	H \pm 5 (mm)	Qty. (pcs)	Inner Box (pcs)	Total (pcs)	
5x6	235	320	54	2000	10	20,000	490x330x293
6.3x (6 ~ 9.5)	235	320	54	1500		15,000	490x330x293
8x (7 ~ 12)	235	320	51	1000		10,000	490x330x285
8x (16 ~ 20)	255	320	63	1000	8	8,000	490x330x275
10x (8 ~ 20)	218	325	57	600	5	3,000	340x223x305

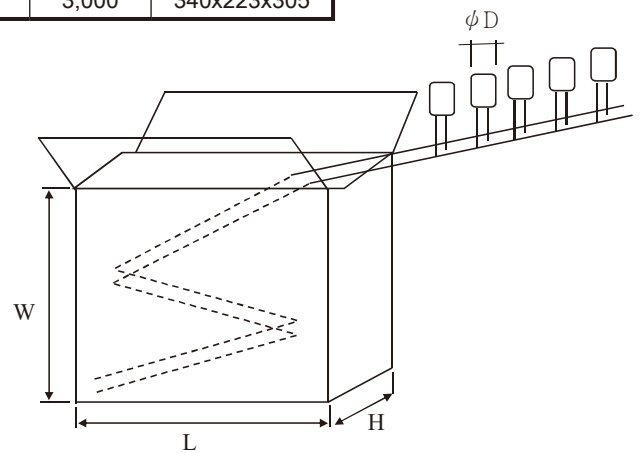

Carrier Tape

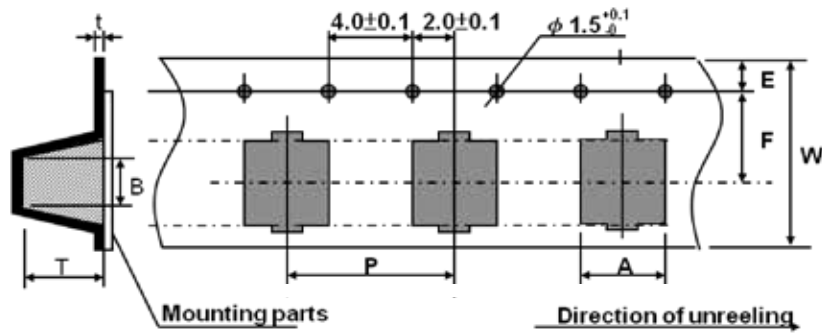

(Unit:mm)

ΦDxL	A	B	W	F	E	P	t	T
5×6	5.7±0.2	5.7±0.2	12.0±0.3	6.5±0.1	1.75±0.1	12.0±0.1	0.4±0.1	7.5±0.2
6.3×6	7.0±0.2	7.0±0.2	16.0±0.3	7.5±0.1	1.75±0.1	12.0±0.1	0.4±0.1	8.0±0.2
6.3x(7~8)	7.0±0.2	7.0±0.2	16.0±0.3	7.5±0.1	1.75±0.1	12.0±0.1	0.4±0.1	8.0±0.2
6.3×9.5	7.0±0.2	7.0±0.2	16.0±0.3	7.5±0.1	1.75±0.1	12.0±0.1	0.4±0.1	10.0±0.2
8×7	8.7±0.2	8.7±0.2	24.0±0.3	11.5±0.1	1.75±0.1	16.0±0.1	0.4±0.1	8.8±0.2
8x(9.5~10)	8.7±0.2	8.7±0.2	24.0±0.3	11.5±0.1	1.75±0.1	16.0±0.1	0.4±0.1	11.0±0.2
8x12	8.7±0.2	8.7±0.2	24.0±0.3	11.5±0.1	1.75±0.1	16.0±0.1	0.4±0.1	13.0±0.2
10X8	10.7±0.2	10.7±0.2	24.0±0.3	11.5±0.1	1.75±0.1	16.0±0.1	0.4±0.1	8.5±0.2
10x10.5	10.7±0.2	10.7±0.2	24.0±0.3	11.5±0.1	1.75±0.1	16.0±0.1	0.4±0.1	11.0±0.2
10x(12~12.5)	10.7±0.2	10.7±0.2	24.0±0.3	11.5±0.1	1.75±0.1	16.0±0.1	0.4±0.1	(13~13.5)±0.2

Reel

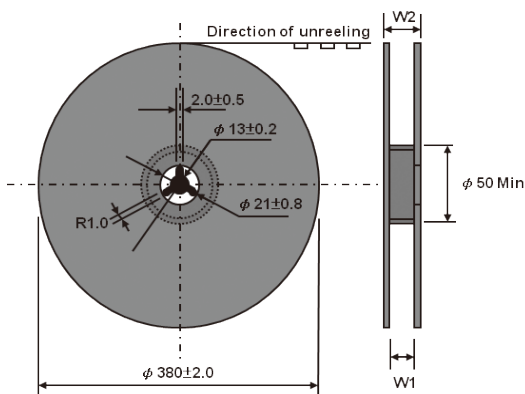

Polarity

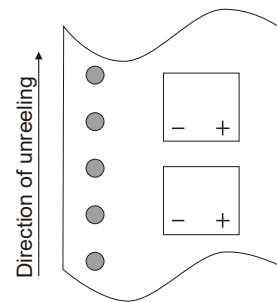

PACKAGE BOX

(Unit:mm)

Size Code ΦDxL	W1	W2	Q'ty / Reel	Size of Inner Box (L)x(W)x(H)	Size of Out Box (L)x(W)x(H)
5×6	14.0±1.0	18.0±1.0	1000 pcs.	385x385x106	412x403x255
6.3×(6~8)	18.0±1.0	22.0±1.0	1000 pcs.	385x385x125	412x403x293
6.3×9.5	18.0±1.0	22.0±1.0	800 pcs.	385x385x125	412x403x293
8×(7~10)	26.0±1.0	30.0±1.0	500 pcs.	385x385x106	412x403x255
10×(8~10.5)	26.0±1.0	30.0±1.0	500 pcs.	385x385x106	412x403x255
(8~10)×12.5	26.0±1.0	30.0±1.0	400 pcs.	385x385x106	412x403x255

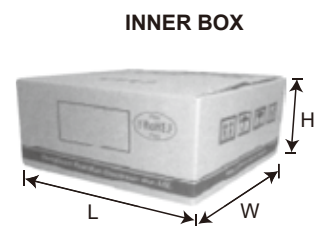

Inner Box Size:
(L) X (W) X (H)

Series Chart

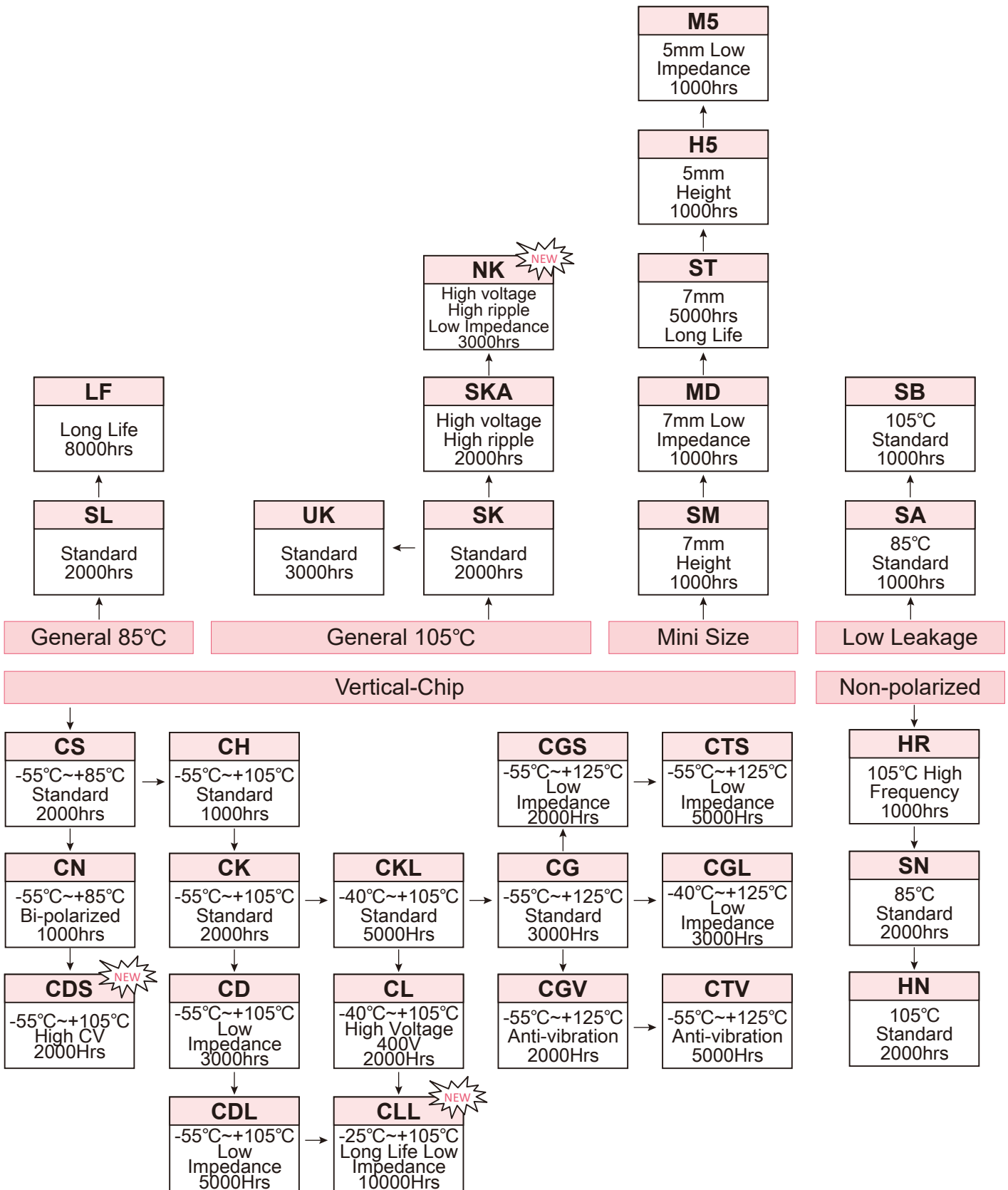

Series Chart

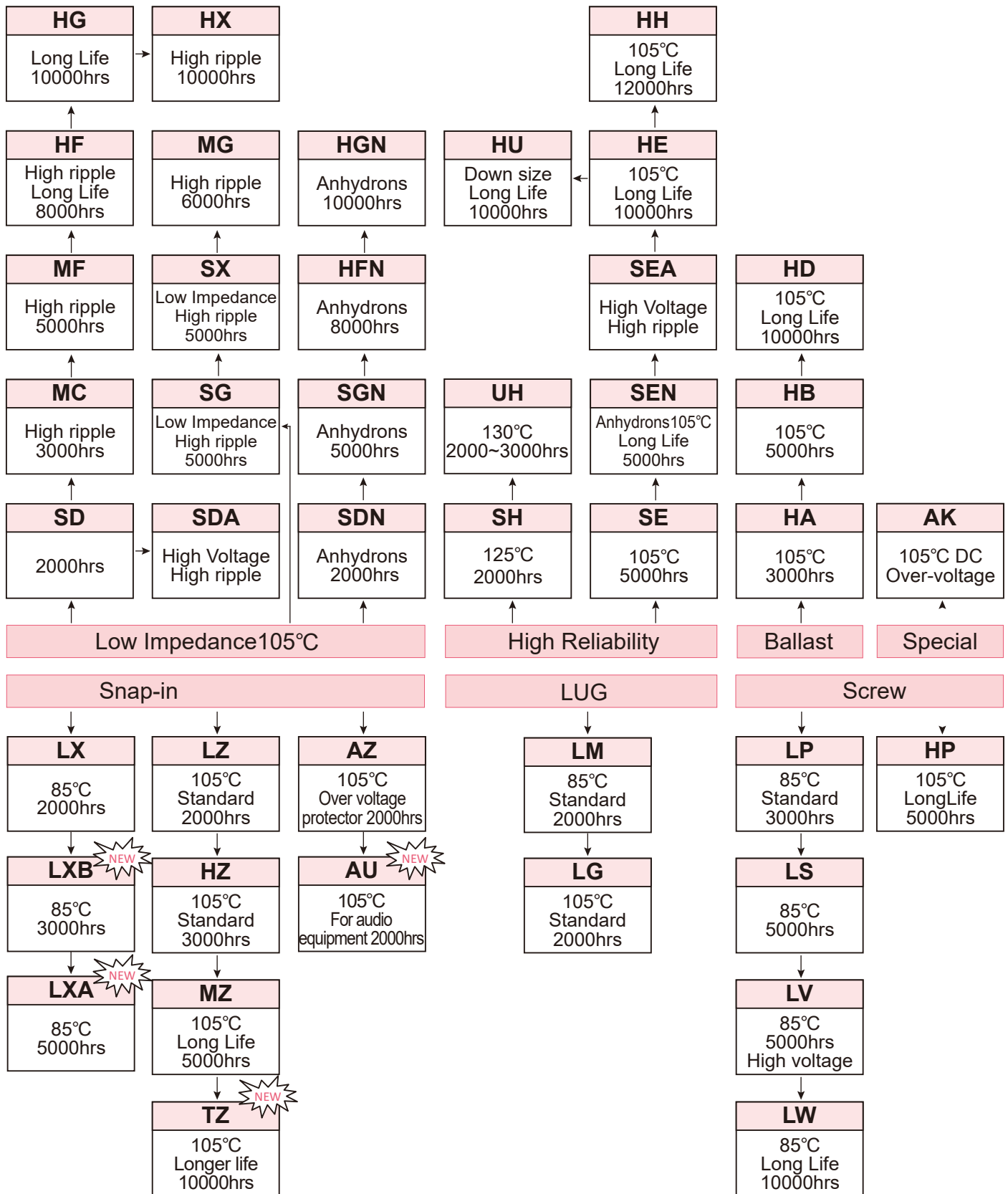

Application Guidelines For Aluminum Electrolytic Capacitors

鋁電解電容器使用需知

一、電路設計的注意事項

1. 在確認使用環境及安裝環境的基礎上，在電容器的產品目錄及規格書上所規定的性能範圍內進行設計。
2. 在設計上，應該避免在下述情況下使用：
 - (1) 不可超過電容器的最高使用溫度。
 - (2) 不可有超過額定紋波電流的電流通過。
 - (3) 不可有超過額定電壓的電壓通過電容器。
 - a. 要注意紋波電壓(交流部分)重疊到直流電壓上時的峰值不可超過額定電壓。
 - b. 當兩個電容器串聯時，通過各個電容器的電壓不可超過額定電壓。此時，要在各個電容器上並聯用於防止漏損電流的分壓電阻器。
 - (4) 電容器為極性電容器。要確認有無連接反向電壓或交流電壓。在極性反轉電路中請用雙極性電容器，但是雙極性電容器也不可以用於交流電路。
3. 進行電路設計時，請選用與機器壽命相符的電容器。
4. 在需要重複進行急速充放電的電路中請選用與條件相符的電容器。
5. 電容器的外殼、輔助引出端子與正、負極以及電路板間必須完全隔離。
6. 當電容器套管的絕緣不能保證時，在有絕緣性能特定要求的地方請不要使用。需要外套具有絕緣功能時請諮詢我們。
7. 電容器如果在以下環境中使用，可能會發生故障。
 - (1) 直接與水、油類、鹽水相接觸的環境或高溫高濕或結露的環境。
 - (2) 充滿有毒氣體(硫化物、亞硫酸、亞硝酸、氯氣、氨水等)的環境。
 - (3) 不能置於日照、O₃、紫外線及有放射性物質環境下使用。
 - (4) 有酸性及鹼性溶劑濺落的環境。
 - (5) 振動或衝擊條件超過交貨仕様書規定範圍的惡劣環境。

一、Caution During Circuit Design

1. Please make sure the application and mounting conditions to which the capacitor will be exposed are within the conditions specified in the catalog or alternate product specification (Referred as to specification here after).
2. Design Aluminum Electrolytic Capacitors, please pay attention to the points listed below:
 - (1) The capacitor shall not be used in an ambient temperature which exceeds the operating temperature specified in the specification.
 - (2) Do not apply excessive current which exceeds the allowable ripple current.
 - (3) Make sure that no excess voltage (that is higher than the rated voltage) is applied to the capacitor.
 - a. Please pay attention that the peak voltage, which is DC voltage overlapped by ripple current, should not exceed the rated voltage.
 - b. In the case where more than 2 aluminum electrolytic capacitors are used in series, please make sure that applied voltage will be lower than rated voltage and the voltage be will applied to each capacitor equally using a balancing resistor in parallel with the capacitors.
 - (4) Aluminum electrolytic capacitors are polarized. Make sure that no reverse voltage or AC voltage is applied to the capacitors. Please apply bi-polarized capacitor to reverse polarity circuit but bi-polarized capacitors can not be applied to AC circuit.
3. Appropriate capacitors which comply with the life requirement of the products should be selected when designing the circuit.
4. For a circuit that repeats rapid charging/discharging of electricity, an appropriate capacitor that is capable of enduring such a condition must be used.
5. Aluminum case, cathode lead wire, anode lead wire and circuit pattern must be isolated .
6. The sleeve of capacitors is not recognized as an insulator, and therefore, the standard capacitor should not be used in a place where insulation function is needed. If you require a higher grade of insulating sleeve, please consult us.
7. Capacitors may fail if they are used under the following conditions:
 - (1) Damp conditions such as water, saltwater spray, or oil spray or fumes. High humidity or humidity condensation situations.
 - (2) In an atmosphere filled with toxic gasses (such as hydrogen sulfide, sulfurous acid, nitrous acid, chlorine, ammonia, etc.)
 - (3) Being exposed to direct sunlight, ozone, ultraviolet ray, or radiation.
 - (4) Being exposed to acidic or alkaline solutions.
 - (5) Under severe conditions where vibration and / or mechanical shock exceed the applicable ranges of the specification.

Application Guidelines For Aluminum Electrolytic Capacitors

鋁電解電容器使用需知

- | | |
|---|---|
| <p>8. 在設計電容器的安裝時，必須確認下述內容：</p> <p>(1) 电路板的孔距必須與電容器兩端子的間距相吻合。</p> <p>(2) 在電容器防爆閥的上方盡量不要安裝配線及其它元件，應在防爆閥的上方保留一定的空間。</p> <p>∅</p> <p> $\phi 8(6.3) \sim \phi 16 : 2\text{mm}$以上
 $\phi 18 \sim \phi 35 : 3\text{mm}$以上
 $\geq \phi 40 : 5\text{mm}$以上</p> <p>(3) 請勿在電容器的四周及电路板的背面(電容器下面)配置發熱元件。</p> <p>(4) 請勿在電容器的封口部下方進行电路配線。如果在電容器附近配線，請確保線路間隔在2mm以上。</p> <p>(5) 螺栓型電容器在主體安裝螺絲時，鎖緊的扭力不要超過產品目錄或規格說明書規定的範圍。此外，橫放時，防爆閥的位置不可居於下方。</p> <p>9. 電容器的電氣特性根據溫度及頻率的變動而變化，請在確認該變化量的基礎上進行电路設計。</p> <p>10. 在雙面印刷板上安裝電容器時，電容器的安裝位置避免多餘的基板孔和過孔。</p> <p>11. 並聯兩個以上的電容器時，要充分考慮電流平衡。</p> <p>12. 串聯兩個以上的電容器時，要充分考慮電壓平衡和插入並聯用分壓相抗。</p> | <p>8. In designing a circuit, the following matters should be ensured in advance to the capacitor assembly on the P.C. board.</p> <p>(1) Design the appropriate hole spacing to match the lead pitch of capacitors.</p> <p>(2) Do not locate any wiring and circuit patterns directly above the capacitor vent. Ensure enough free space above the capacitor vent.</p> <p> $\phi 8(6.3) \sim \phi 16 : 2\text{mm}$以上
 $\phi 18 \sim \phi 35 : 3\text{mm}$以上
 $\geq \phi 40 : 5\text{mm}$以上</p> <p>(3) Do not design a circuit board so that heat generating components are placed near an aluminum electrolytic capacitor or reverse side of P.C. board (under the capacitor).</p> <p>(4) Do not print any copper trace under the seal (terminal) side of a capacitor. Copper traces should be 2mm spaced apart from the side of the capacitor body.</p> <p>(5) For a screw terminal type capacitor. Tightening the terminal screws and the mounting clamp should be within the maximum torque specified in the catalogs or product specifications. Do not mount a screw terminal type capacitor with the terminal facing downward. Also, if the body of a capacitor is installed horizontally such as being laid on its side. Do not position the pressure relief vent downward.</p> <p>9. Electrical characteristics may vary depending on changes in temperature and frequency. Please consider this variation when you design circuits.</p> <p>10. When you mount capacitors on the double-sided P.C. boards, avoid excess substrate holes and vias to capacitor location.</p> <p>11. When you install more than 2 capacitors in parallel, consider the balance of current flowing through the capacitors.</p> <p>12. If more than 2 aluminum electrolytic capacitors are used in series, make sure the applied voltage will be lower than the rated voltage and that voltage will be applied to each capacitor equally using a balancing resistor in parallel with each capacitor.</p> |
|---|---|

二、安裝的注意事項

- 除了定期點檢時為檢測電氣性能而拆卸的電容器外，對組裝到設備上已經通電的電容器，拆除後均不能再使用。
- 當電容器產生再生電壓時，請通過約1K Ω 的電阻器進行放電。
- 長期保存的電容器，需通過約1K Ω 的電阻加壓處理。
- 請確認電容器的規格(靜電容量及額定電壓)及極性後，才可進行安裝。
- 掉落在地上的電容器及本體已經變形的電容器，請勿再使用。

二、Caution For Assembling Capacitors

- Once a capacitor has been assembled in the set and power applied, even if a capacitor is discharged, an electric potential (restricting voltage) may exist between the terminals.
- Electric potential between positive and negative terminal may exist as a result of returned electromotive force, so please discharge the capacitor using a 1K Ω resistor.
- Leakage current of aluminum electrolytic capacitors may be increased during long storage time. In this case, the capacitors should be subjected to voltage treatment a 1K Ω resistor before using.
- Please confirm ratings (voltage and capacitance) and polarity before in stalling capacitors on the P.C. board.
- Do not drop capacitors on the floors and damage, nor use a capacitors that was dropped.

Application Guidelines For Aluminum Electrolytic Capacitors

鋁電解電容器使用需知

- | | |
|---|--|
| <p>6. 安裝時請確認電路板的孔距是否與電容器兩端子的間距吻合。</p> <p>7. 自動插入機扭結固定電容器引線的強度不可過大。</p> <p>8. 焊接時請注意以下內容：</p> <p>(1) 焊接條件(溫度、時間)不可超出承認書中所規定的範圍。</p> <p>(2) 請勿讓烙鐵的烙鐵頭接觸到電容器的本體及不要將電容器本體浸入焊錫溶液中。</p> <p>(3) 在進行焊接時，避免其它物件倒下碰到電容器。</p> <p>(4) 在進行焊接時，除端子外電容器其它部位不可附著有焊劑。</p> <p>9. 電容器焊接在電路板後，請注意以下內容：</p> <p>(1) 不可將電容器本體傾斜、扭轉等。</p> <p>(2) 不可讓其它物體碰到電容器。</p> <p>10. 電解電容器不得以鹵化化學藥品類似溶劑，作為電容器洗滌用。</p> <p>11. 在使用固定劑與塗層劑時，電路板與電容器的封口部之間須乾淨，不可留有焊劑殘渣及污垢。</p> | <p>6. Please confirm that lead spacing of the capacitor matches the hole spacing of the P.C. board prior to installation.</p> <p>7. Please pay attention that the clinch force is not too strong when capacitors are placed and fixed by an automatic insertion machine.</p> <p>8. Soldering</p> <p>(1) Soldering condition (temperature and times) must be confirmed to be within Su'scon specification.</p> <p>(2) Soldering iron should never touch the capacitors body and do not dip capacitors body into melted solder.</p> <p>(3) Please avoid contact between other components and the aluminum capacitor.</p> <p>(4) Please avoid having flux adhere to any portion except the terminal.</p> <p>9. After Soldering</p> <p>(1) Do not bend or twist the capacitors body after soldering on P.C. board.</p> <p>(2) Do not hit the capacitors and isolate capacitors from the P.C. board or other device when stacking P.C. boards in store.</p> <p>10. Standard Aluminum Electrolytic Capacitors should be free from halogenated solvents during P.C. board cleaning after soldering.</p> <p>11. Do not use halogenated adhesives and coating materials to fix aluminum electrolytic capacitors.</p> |
|---|--|

三、組裝使用注意事項

1. 不可直接觸摸電容器的端子，有導致觸電的危險。
2. 不可有導電體靠近電容器的兩端子，避免電容器端子之間短路。
3. 裝配了電容器的設備請不要在以下環境中使用：
 - (1) 直接與水、油類、鹽水相接觸的環境或高溫高濕或結露的環境。
 - (2) 充滿有毒氣體(硫化物、亞硫酸、亞硝酸、氯氣、氨水等)的環境。
 - (3) 不能置於日照、O₃、紫外線及有放射性物質環境下使用。
 - (4) 有酸性及鹼性溶劑濺落的環境。
 - (5) 振動或衝擊條件超過交貨仕様書規定範圍的惡劣環境。

四、電容器的保養與檢修

電容器在工業機器中使用時要進行定期檢修，檢修時請注意電容器的外觀及電氣性能是否符合產品的標準。

五、安全注意事項

1. 在設備使用過程中，電容器的防爆閥開裂，並冒出氣體時，應切斷設備的主電源或從設備上拔下電線插頭。

三、Caution For Assembling Capacitors

1. Do not directly touch terminal by hand.
2. Keep electric conductor off terminals to avoid short circuit.
3. Do not use following conditions for assembling capacitors.
 - (1) Damp conditions such as water, saltwater spray, or oil spray or fumes. High humidity or humidity condensation situations.
 - (2) In an atmosphere filled with toxic gasses (such as hydrogen sulfide, sulfurous acid, nitrous acid, chlorine, ammonia, etc.)
 - (3) Being exposed to direct sunlight, ozone, ultraviolet ray, or radiation.
 - (4) Being exposed to acidic or alkaline solutions.
 - (5) Under severe conditions where vibration and / or mechanical shock exceed the applicable ranges of the specification.

四、Maintenance Inspection

Please periodically inspect the capacitors that are installed in industrial equipment. Remarkable abnormality such as vent operating, leaking electrolyte, etc. Capacitance, dielectric loss tangent, leakage current, and items specified in the specification.

五、Safe Precautions

1. If you see smoke due to operation of safety vent, turn off the main switch or pull out the plug from the outlet.

Application Guidelines For Aluminum Electrolytic Capacitors

鋁電解電容器使用需知

2. 電容器的防爆閥開裂時，因為超過100°C高溫氣體噴出，臉不要接近。噴出的氣體進入眼睛時，立即用清水清洗眼睛。如果噴出的電解液濺到皮膚上，請立即使用肥皂進行沖洗。

2. Do not bring your face near the capacitor when the pressure relief vent operates, because the gases emitted from that are over 100°C. If the gas gets into your eyes, please flush your eyes immediately with pure water. If electrolyte exposed on your skin, please wash it with soap and water.

六、儲存條件

1. 電容器建議在環境溫度5 ~ 35°C、相對濕度低於75%的條件下存放。
2. 請勿儲存於下列所述的環境中。
 - (1) 直接與水、油類、鹽水相接觸的環境或高溫高濕或結露的環境。
 - (2) 充滿有毒氣體(硫化物、亞硫酸、亞硝酸、氯氣、氨水等)的環境。
 - (3) 不能置於日照、O₃、紫外線及有放射性物質環境下使用。
 - (4) 有酸性及鹼性溶劑濺落的環境。
 - (5) 振動或衝擊條件超過交貨仕様書規定範圍的惡劣環境。

六、Storage

1. It is recommended to keep capacitors between the ambient temperatures of 5°C to 35°C and a relative humidity of 75% or below.
2. Confirm that the environment does not have any of the following conditions:
 - (1) Damp conditions such as water, saltwater spray, or oil spray or fumes. High humidity or humidity condensation situations.
 - (2) In an atmosphere filled with toxic gasses (such as hydrogen sulfide, sulfurous acid, nitrous acid, chlorine, ammonia, etc.)
 - (3) Being exposed to direct sunlight, ozone, ultraviolet ray, or radiation.
 - (4) Being exposed to acidic or alkaline solutions.
 - (5) Under severe conditions where vibration and / or mechanical shock exceed the applicable ranges of the specification.

3.

分類	規格	儲存壽命
中高壓產品	160V(含)以上	2年; 一年以上, 需要做特性檢驗, 如果特性異常, 需要再次充電老化
低壓產品	120V(含)以下	2年

註：再次老化的條件視規定而定

3.

Category	Description	Storage life
Mid-High Voltage	160V and above	2yrs; after 1yr, needs to check characteristics; if NG, needs to do aging
Low Voltage	120V and below	2yrs

Remark: Re-aging condition depends on its own spec.

七、廢棄處理

1. 在電容器上開孔或壓碎後焚燒。
2. 電容器不焚燒時，請交給專業的工業廢棄物處理廠處理。

七、Disposal

1. Make a hole the in the capacitor body or crush capacitors and incinerate them.
2. If incineration is not applicable, hand them over to a waste disposal agent and have them buried in a landfill.

八、特別注意事項

在選用電容器時，如果在產品目錄及規格書中沒有找到符合要求的系列或規格時，請直接與我們的業務部或研發部聯繫，我們可根據客戶的要求開發特殊性能產品。上述鋁電解電容器的使用注意事項依據EIAJRCR-2367B 2002年3月發行的《電子機器用固定鋁電解電容器使用注意事項指南》製作而成，詳情請參照該指南。

八、Special Notice

When choosing capacitors, if clients couldn't find the series or specification in catalogue and data sheet, please contact with our Sales or RD department, we are able to base on clients' needs to develop product with special functions. For further details, please refer to EAIJ RCR-2367B-Guideline of notabilia for fix for use in electronic equipment [Technical Standardization Committee on Passive Components (established in March 1995, revised in March 2002)]

Environment Protection Policy

We are reducing environmentally harmful substances to do our capacitors in global environmental protection activities. Products compatible with Pb-free and products with non-PVC encasing and ROHS Compliance materials are available.

● ROHS Compliance

Our capacitors do not use any of the materials specifically identified and restricted hazardous material under ROHS Prohibited

Pb : Lead, **Cr6+**: Hexavalent chromium, **Hg**:Mercury, **Cd**:Cadmium, **PBB**:Polybrominated biphenyls, **PBDE** : Polybrominated diphenylethers, **PVC**:Polyvinyl chloride

Application Guidelines For Aluminum Electrolytic Capacitors

鋁電解電容器使用需知

● PVC free Capacitors

We use PET (Polyethylene Terephthalate) sleeve to instead of PVC (Polyvinyl Chloride) sleeve since 2005 January. As there is a size limitation for this counter measure, Please consult our sales representative their availability in big size capacitors.

● Pb-Free Capacitors

Our Capacitors lead wire and terminal doesn't contain lead.

We follow up those conditions as rule and standards to use right materials to production capacitors for maintain earth environment everlasting for human.

Effects of ambient temperature to life (for reference)

Because an aluminum electrolytic capacitor is essentially an electrochemical component, increase temperatures accelerate the chemical reaction producing gas within the capacitor, diffuse the gas to outside through the end seal, and consequently accelerate a gradual decrease in capacitance and a gradual increase in $t_{en\delta}$ and ESR, the following equation has been experimentally found to express the relationship between the temperature acceleration factor and the deterioration of the capacitor.

- Where : $L_x = L_o \cdot K_{temp} = L_o \cdot B^{(T_o - T_x)/10}$
 $K_{temp} = B^{(T_o - T_x)/10}$
 L_x = Life time (hour) of capacitor to be estimated
 L_o = Base life time (hour) of capacitor
 T_o = Maximum rated operating temperature (°C) of capacitor shown in catalog
 T_x = Actual ambient temperature (°C) of capacitor
 B = Temperature acceleration factor (=2)

This equations is similar to Arrhenius equation that express a relationship between chemical reaction rates and temperature and called Arrhenius rule of aluminum electrolytic capacitors.

The temperature acceleration factor (B) is approximately 2 over an ambient temperature range (T_x) from 40°C to the maximum rated operating temperature of the capacitor, and it means that the lifetime is approximately halved with every 10°C rise in ambient temperature and can be extended by using the capacitors at low temperatures.

For an ambient temperature range (T_x) of 20°C to 40°C, the factor B will be close to 2, and the lifetime will be actually extended. However, the environment where the devices are placed and their operating conditions influence ambient temperature, and in particular the ambient temperature in this range will be very inconstant. Therefore, a minimum lifetime should be estimated from the above formula by using the 40°C as T_x .

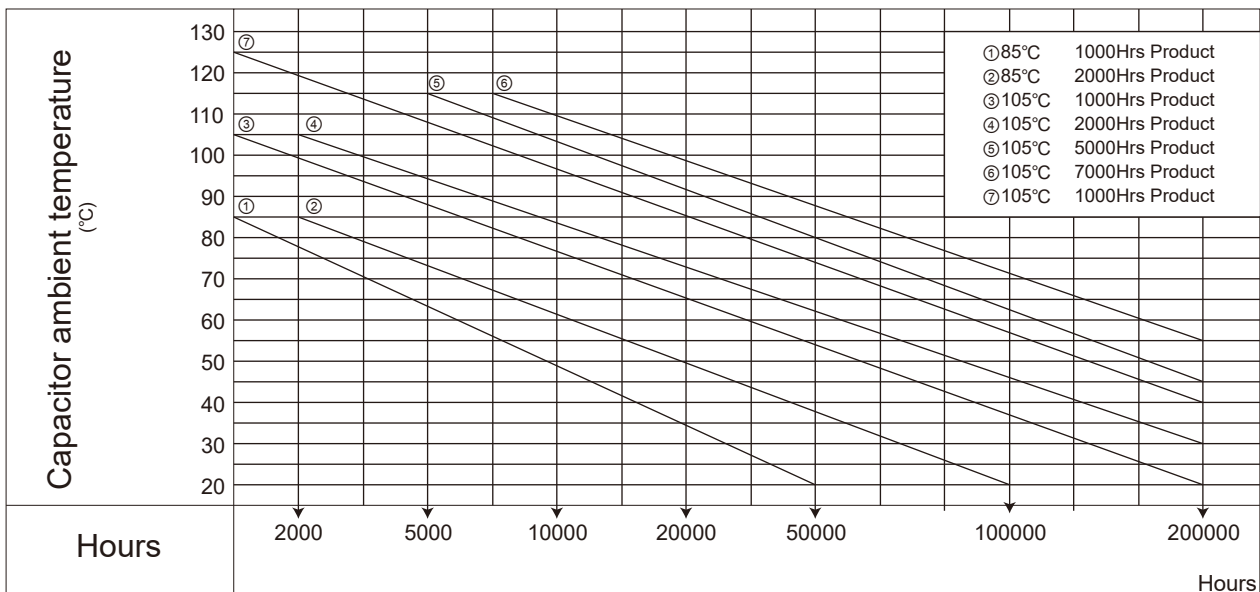

※ 1. A guide limit of the calculated like Aimo is 15 years max
 2. $T_x \geq 40^\circ\text{C}$

Application Guidelines For Aluminum Electrolytic Capacitors

鋁電解電容器使用需知

RECOMMENDED PB-FREE REFLOW SOLDERING CONDITIONS

The following conditions are recommended for air or infrared reflow soldering of the surface mount capacitors onto a glass epoxy circuit board of 95 x 50 x 0.8mm (with resist) by cream solder (eutectic solder). The temperatures shown are the surface temperature values of the top of the capacitor.

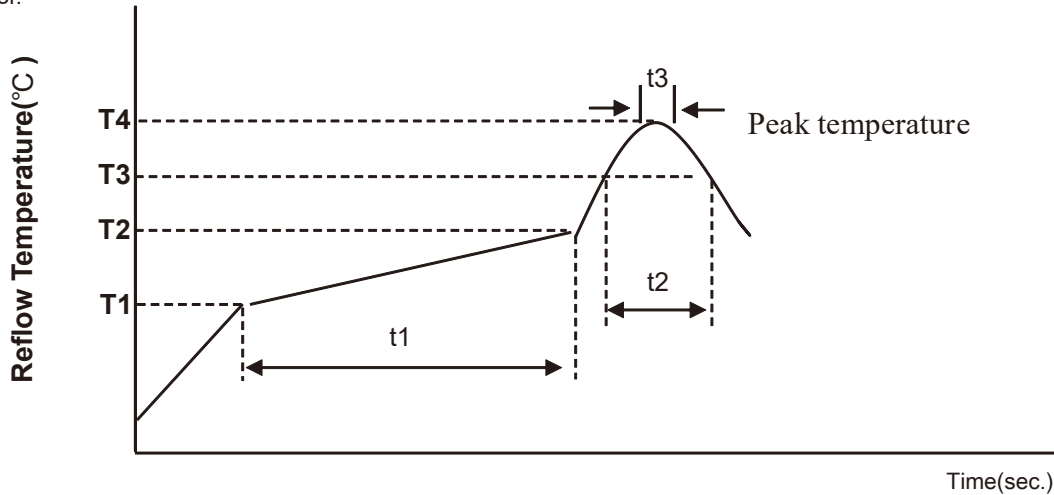

TEMPERATURE PROFILE

Profile Feature	Pb Free Assembly	
	4~6.3Ø	8~16Ø
Average Ramp-up Rate	3°C/second max.	3°C/second max.
Preheat		
Temperature Min(T1 min)	150°C	150°C
Temperature Max(T2 max)	180°C	180°C
Time (t1 Max)	120sec.	120sec.
Ramp-up Rate (T2 ~T3)	3°C/second max.	3°C/second max.
Time maintained above Temperature(T3)	217°C	217°C
Time(t2 Max)	90sec.	40sec.
Peak Temperature(T4)	260°C	245°C
Time(t3 Max)	5sec.	5sec.
Reflow cycles	1	2 or less

RECOMMENDED LAND PATTEND DIMENSION OF PCB

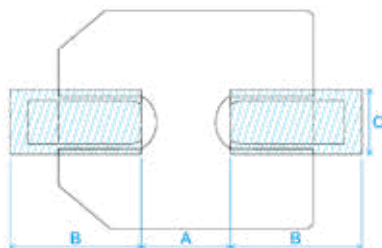

DxL	a	b	c
Φ4	1.0	2.6	1.6
Φ5	1.4	3.0	1.6
Φ6.3	1.9	3.5	1.6
Φ8	3.0	3.5	2.5
Φ10	4.0	4.0	2.5
Φ12.5	4.3	5.8	2.5
Φ16	6.6	6.5	5.0
Φ8(G)	2.5	4.5	4.7
Φ10(G)	3.8	4.8	4.7
Φ12.5(G)	3.8	6.1	6.9
Φ16(G)	5.0	8.0	9.5

“(G)” “Anti-vibration Structure”.

Application Guidelines For Aluminum Electrolytic Capacitors

鋁電解電容器使用需知

PRECAUTIONS FOR USERS**Soldering method**

The capacitors of Alchip-series have no capability to withstand such dip or wave soldering as totally immerses components into a solder bath.

Reflow soldering

Reflow the capacitors within recommended reflow soldering conditions. Verify no temperature stress to the capacitors because the following differences might degrade capacitors electrically and mechanically. Please consult us if other reflow conditions are employed.

1. Location of components : Temperature increases at the edge of PC board more than the center.
2. Population of PC board : The less the component population is the more temperature rises.
3. Material of PC board : A ceramic made board needs more heat than a glass epoxy made board. The heat increase may cause damage of the capacitors.
4. Thickness of PC board : A thicker board needs more heat than a thinner board. The heat increase may damage the capacitors.
5. Size of PC board : A larger board needs more heat than a smaller board. The heat increase may damage the capacitors.
6. Location of infrared ray lamps : IR reflow as well as hot plate reflow applies heat only on the reverse side of the PC board to lessen heat stress to the capacitors.
7. Vapor heat transfer systems (VPS) are not recommended.

Rework of soldering

Avoid reflow soldering more than once. Use a soldering iron for rework. Do not exceed an iron tip temperature of $380 \pm 10^{\circ}\text{C}$ and an exposure time of 3 ± 0.5 seconds.

Mechanical stress

Do not use the capacitors for lifting the PC board and give stress to the capacitor. Avoid bending the PC board. These may damage the capacitors.

Cleaning assembly board

Immediately after solvent cleaning, remove residual solvent for at least 10 minutes with an air knife. The solvent is so insufficiently dry for a long period of time that the capacitors may be cored.

Coating on assembly board

1. Before curing coating material remove the cleaning solvents from the assembly board.
2. Before conformal coating, a chloride free pre-coat material is recommended to use for lessening stress to the capacitors.

Molding with resin

Internal chemical reaction gradually produces gas in the capacitor; then, internal pressure is increasing. If the end seal of the capacitor is completely molded with a resin. The gas stays inside the capacitor. It will face dangerous situation. The chlorine contained resin will penetrate into the end seal, reach the inside element, and cause damage of the capacitor.

Others

Precautions and Guidelines for Aluminum Electrolytic Capacitors shall be referred.

Application Guidelines For Aluminum Electrolytic Capacitors

鋁電解電容器使用需知

Analysis of Failure Mode

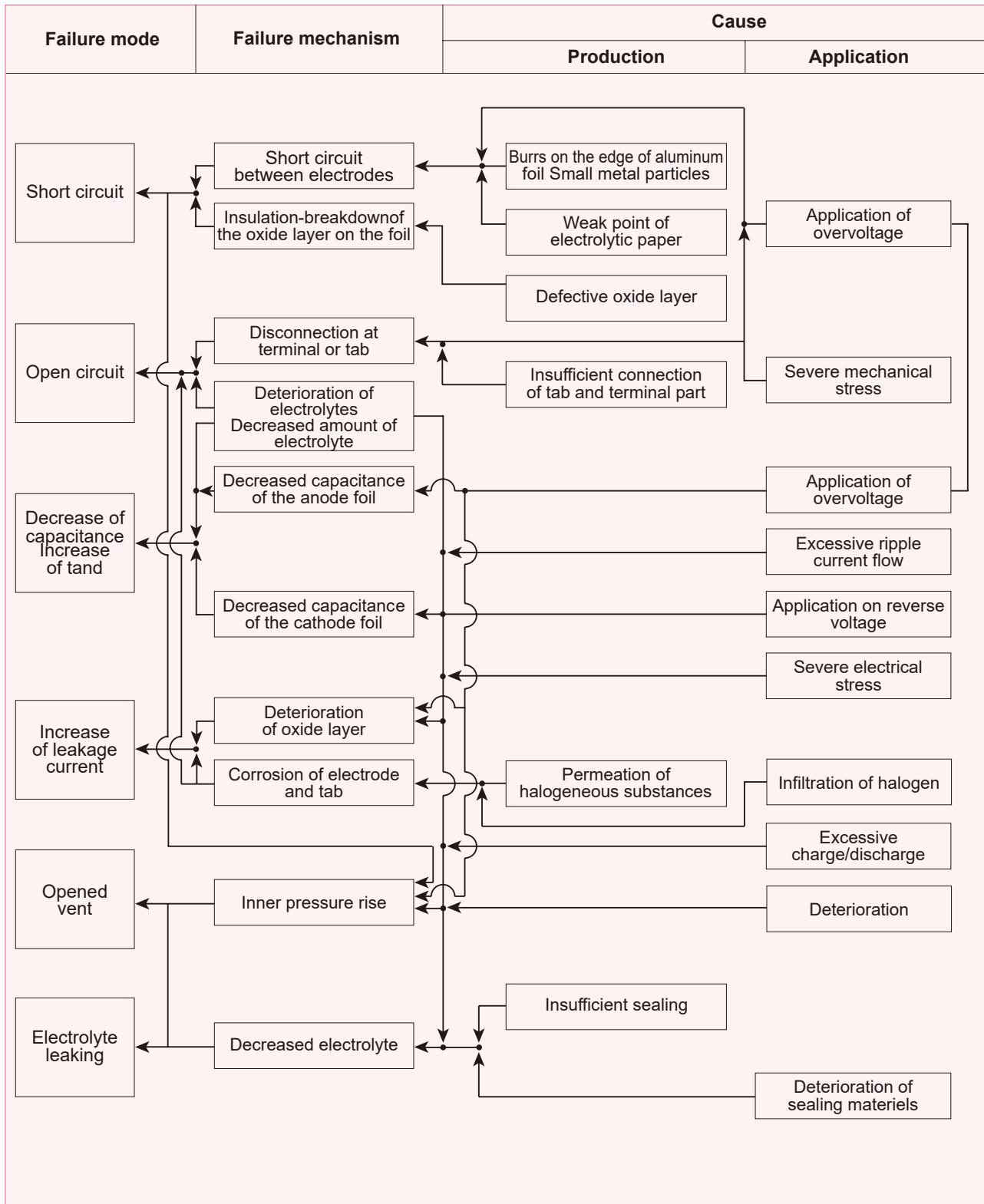

Application Guidelines For Aluminum Electrolytic Capacitors

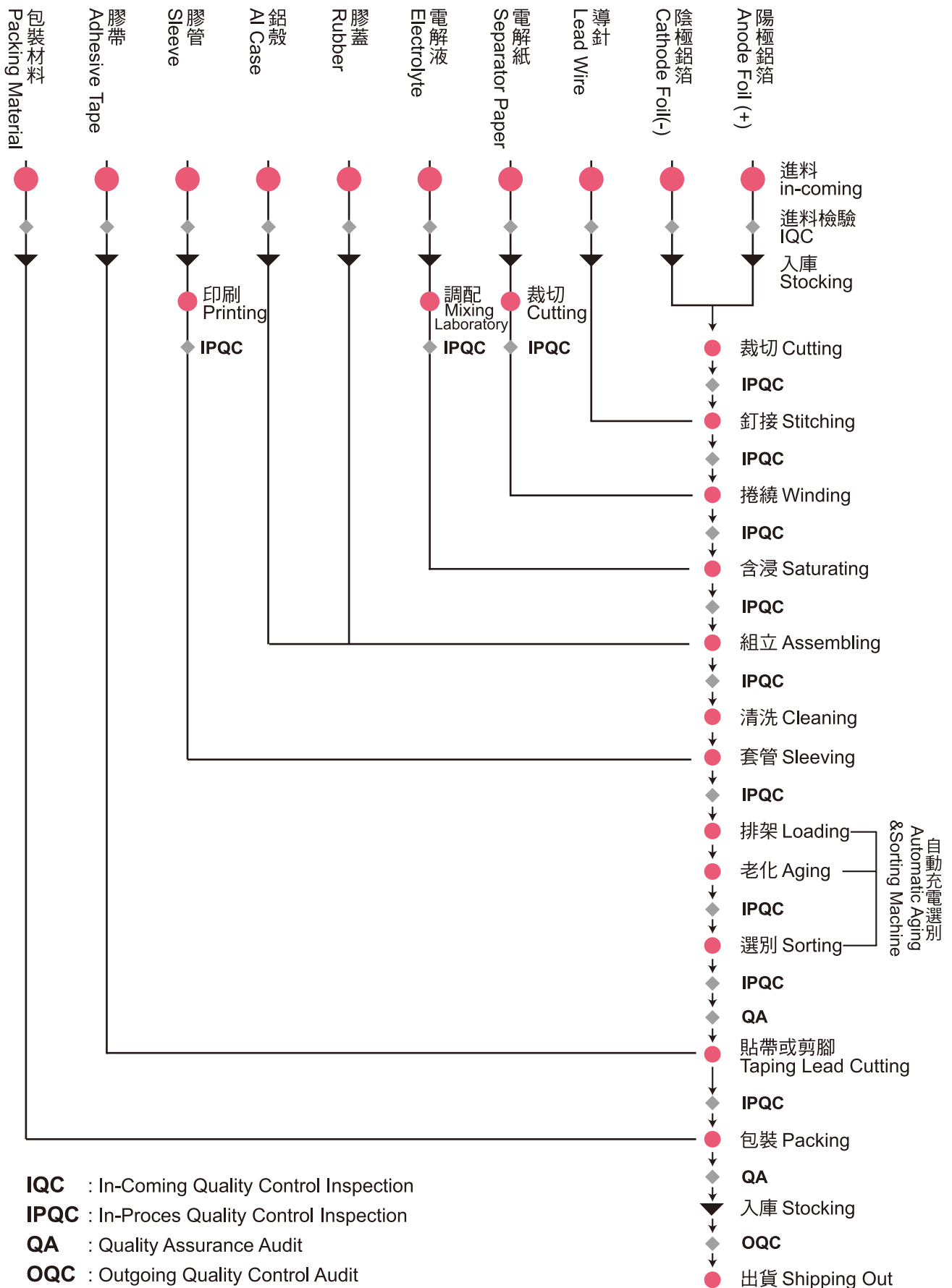

IQC : In-Coming Quality Control Inspection
IPQC : In-Process Quality Control Inspection
QA : Quality Assurance Audit
OQC : Outgoing Quality Control Audit

CS series

- Standard type of V-chip, -55 ~ +85°C.
- Applicable to SMT process.
- RoHS Compliance.
- -55 ~ +85°C V-Chip型標準品。
- 適用於SMT製程。



SPECIFICATIONS

Items 項目	Characteristics 特性								
Capacitance Tolerance 靜電容量誤差	± 20%(120Hz,20°C)								
Operating Temperature Range 適用溫度範圍	-55 ~ +85°C								
Rated Voltage Range 額定電壓範圍	4 ~ 100VDC								
Capacitance Range 靜電容量範圍	0.1 ~ 1500μF								
Leakage Current 洩漏電流	$I \leq 0.01CV$ or $3(\mu A)$, which is greater. (After 2 minutes application of DC rated voltage, at 20°C)								
Dissipation Factor 散逸因素(tan δ)	Measurement Frequency: 120Hz. Temperature: 20°C								
	Rated Voltage(V)	4	6.3	10	16	25	35	50	63~100
	tan δ(Max)	0.42	0.30	0.26	0.22	0.16	0.14	0.14	0.12
Low Temperature Stability 低溫特性 Impedance Ratio(Max) 阻抗比率(最大值)	Measurement Frequency: 120Hz.								
	Rated Voltage(V)	4	6.3	10	16	25	35	50	63~100
	Z(-25°C)/Z(20°C)	7	4	3	2	2	2	2	2
	Z(-55°C) / Z(20°C)	15	8	8	4	4	3	3	3
Load Life 負荷壽命	2000hours,with application of rated voltage at 85°C								
	Capacitance Change	Within ± 20% of Initial Value (Within±25% for 4V)							
	tan δ	200% or less of Initial Specified Value							
	Leakage Current	Initial Specified Value or less							
Shelf Life 放置壽命	The following specifications shall be satisfied when the capacitors are restored to 20°C after exposing them for 1,000 hours 85°C without voltage applied. Before the measurement, the capacitor shall be preconditioned by applying voltage according to them 4.1 of JIS C5101-4.								
	Capacitance Change	Within ± 20% of Initial Value							
	tan δ	200% or less of Initial Specified Value							
	Leakage Current	Initial Specified Value or less							
Resistance to Soldering Heat 焊錫耐熱性	The capacitors shall be kept on the hot plate maintained at 250°C for 30 seconds. After removing from the hot plate and restored at room temperature they meet the characteristics requirements listed at right.				Capacitance Change	Within ± 10% of Initial Value			
					tan δ	Initial Specified Value			
					Leakage Current	Initial Specified Value or less			
Marking 標識	Black print on the case top								

Frequency Coefficient of Permissible Ripple Current

Frequency (Hz)	50	120	300	1K	≧10K
Coefficient	0.70	1.00	1.17	1.36	1.50

The endurance of capacitors is reduced with internal heating produced by ripple current at the rate of halving the lifetime with every 10°C rise. When long life performance is required in actual use , the rms ripple current has to be reduced.



CS series

DIMENSIONS(mm)

Chip Type

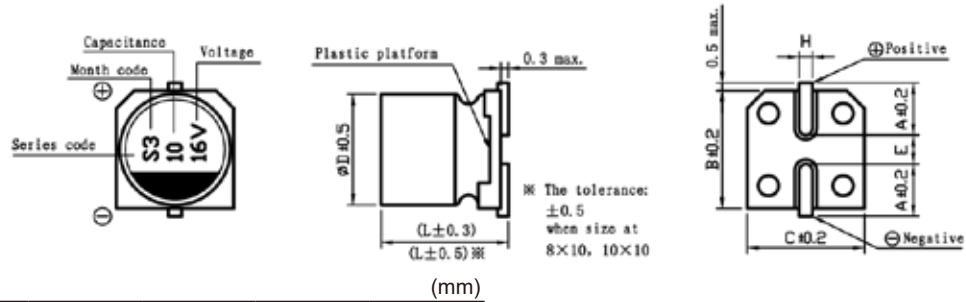

(mm)

ϕ D x L	4x5.4	5x5.4	6.3x5.4	6.3x7.7	8x10	10x10
A	1.8	2.1	2.4	2.4	2.9	3.2
B	4.3	5.3	6.6	6.6	8.3	10.3
C	4.3	5.3	6.6	6.6	8.3	10.3
E	1.0	1.3	2.2	2.2	3.1	4.5
L	5.4	5.4	5.4	7.7	10	10
H	0.5~0.8	0.5~0.8	0.5~0.8	0.5~0.8	0.8~1.1	0.8~1.1

STANDARD RATINGS

D x L (mm) ; R.C. (mA rms) at 85°C 120Hz.

Cap (μF)	V	4		6.3		10		16		25	
	Item	D x L	R.C.	D x L	R.C.	D x L	R.C.	D x L	R.C.	D x L	R.C.
4.7											
10						4x5.4	28	4x5.4	23	4x5.4	23
22		4x5.4	28	4x5.4	28	5x5.4	33	5x5.4	37	5x5.4	34
33		4x5.4	28	4x5.4	28	5x5.4	41	5x5.4	49	6.3x5.4	47
47		4x5.4	33	5x5.4	45	5x5.4	52	6.3x5.4	58	6.3x5.4	57
56		5x5.4	42	6.3x5.4	52	6.3x5.4	57	6.3x5.4	63	6.3x5.4	62
100		5x5.4	56	6.3x5.4	65	6.3x5.4	76	6.3x5.4	86	6.3x7.7	130
150		6.3x5.4	79	6.3x5.4	71	6.3x7.7	130	6.3x7.7	130		
220		6.3x5.4	96	6.3x5.4	105	6.3x7.7	130	6.3x7.7	130	8x10	250
		6.3x7.7	130	6.3x7.7	130			8x10	250		
330		6.3x7.7	130	6.3x7.7	130	8x10	250	8x10	250	10x10	310
470		6.3x7.7	130	8x10	280	8x10	280	10x10	280		
		8x10	250								
680		8x10	300	8x10	300	10x10	350	10x10	350		
1000		10x10	430	10x10	430	10x10	430				
1500		10x10	480	10x10	480						

Cap (μF)	V	35		50		63		100	
	Item	D x L	R.C.	D x L	R.C.	D x L	R.C.	D x L	R.C.
0.1				4x5.4	3.0	4x5.4	2.0		
0.22				4x5.4	5.0	4x5.4	3.0		
0.33				4x5.4	6.0	4x5.4	4.0		
0.47				4x5.4	7.0	4x5.4	5.0		
1				4x5.4	10	4x5.4	8.0	4x5.4	6.0
2.2		4x5.4	12	4x5.4	14	5x5.4	12	5x5.4	10
3.3		4x5.4	16	4x5.4	19	5x5.4	17		
4.7		4x5.4	18	4x5.4	26	5x5.4	23		
10		5x5.4	29	5x5.4	31	6.3x5.4	42		
22		6.3x5.4	46	6.3x5.4	59	6.3x7.7	60	10x10	90
33		6.3x5.4	51	6.3x7.7	75	8x10	110	10x10	90
47		6.3x5.4	63	6.3x7.7	75	8x10	130		
56		6.3x7.7	70	8x10	175	10x10	160		
100		6.3x7.7	70	8x10	175	10x10	170		
		8x10	175						
220		10x10	320	10x10	320				
330		10x10	360						

CH series

- Standard type of V-chip, -55 ~ +105°C.
- Applicable to SMT process.
- RoHS Compliance.
- -55 ~ +105°C V-Chip型標準品。
- 適用於SMT製程。



SPECIFICATIONS

Items 項目	Characteristics 特性								
Capacitance Tolerance 靜電容量誤差	± 20%(120Hz,20°C)								
Operating Temperature Range 適用溫度範圍	-55 ~ +105°C								
Rated Voltage Range 額定電壓範圍	4 ~ 50VDC								
Capacitance Range 靜電容量範圍	0.1 ~ 1500µF								
Leakage Current 洩漏電流	I ≤ 0.01CV or 3(µA) , which is greater. (After 2 minutes application of DC rated voltage, at 20°C)								
Dissipation Factor 散逸因素(tan δ)	Measurement Frequency: 120Hz. Temperature: 20°C								
	Rated Voltage(V)	4	6.3	10	16	25	35	50	
	tan δ(Max)	0.42	0.30	0.26	0.22	0.16	0.14	0.14	
Low Temperature Stability 低溫特性	Measurement Frequency: 120Hz.								
	Rated Voltage(V)	4	6.3	10	16	25	35	50	
	Impedance Ratio(Max) 阻抗比率(最大值)	Z(-25°C)/Z(20°C)	7	4	3	2	2	2	2
	Z(-55°C)/Z(20°C)	15	8	8	4	4	3	3	
Load Life 負荷壽命	1000hours,with application of rated voltage at 105°C								
	Capacitance Change	Within ± 25% of Initial Value							
	tan δ	200% or less of Initial Specified Value							
	Leakage Current	Initial Specified Value or less							
Shelf Life 放置壽命	The following specifications shall be satisfied when the capacitors are restored to 20°C after exposing them for 1,000 hours 105°C without voltage applied. Before the measurement, the capacitor shall be preconditioned by applying voltage according to them 4.1 of JIS C5101-4.								
	Capacitance Change	Within ± 20% of Initial Value							
	tan δ	200% or less of Initial Specified Value							
	Leakage Current	Initial Specified Value or less							
Resistance to Soldering Heat 焊錫耐熱性	The capacitors shall be kept on the hot plate maintained at 250°C for 30 seconds.				Capacitance Change	Within ± 10% of Initial Value			
	After removing from the hot plate and restored at room temperature they meet the characteristics requirements listed at right.				tan δ	Initial Specified Value			
					Leakage Current	Initial Specified Value or less			
Marking 標識	Black print on the case top								

Frequency Coefficient of Permissible Ripple Current

Frequency (Hz)	50	120	300	1K	≧10K
Coefficient	0.70	1.00	1.17	1.36	1.50

The endurance of capacitors is reduced with internal heating produced by ripple current at the rate of halving the lifetime with every 5°C rise. When long life performance is required in actual use , the rms ripple current has to be reduced.

CH

CH series

DIMENSIONS(mm)

Chip Type

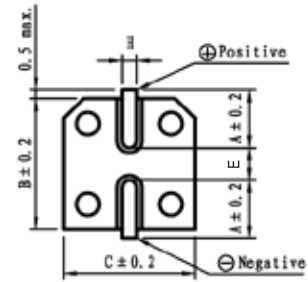
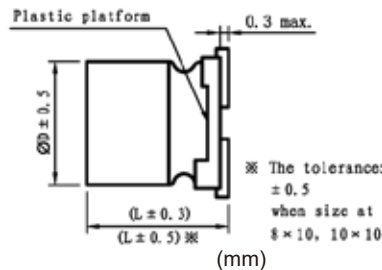
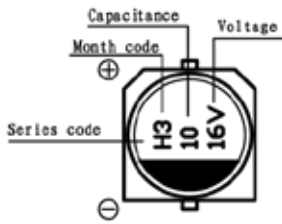

ϕ D x L	4x5.4	5x5.4	6.3x5.4	6.3x7.7	8x10	10x10
A	1.8	2.1	2.4	2.4	2.9	3.2
B	4.3	5.3	6.6	6.6	8.3	10.3
C	4.3	5.3	6.6	6.6	8.3	10.3
E	1.0	1.3	2.2	2.2	3.1	4.5
L	5.4	5.4	5.4	7.7	10	10
H	0.5~0.8	0.5~0.8	0.5~0.8	0.5~0.8	0.8~1.1	0.8~1.1

STANDARD RATINGS

D x L (mm) ; R.C. (mA rms) at 105°C 120Hz.

Cap (μF)	V	4		6.3		10		16	
	Item	D x L	R.C.	D x L	R.C.	D x L	R.C.	D x L	R.C.
10								4x5.4	18
22		4x5.4	22	4x5.4	24	5x5.4	27	5x5.4	30
33		5x5.4	30	5x5.4	33	5x5.4	35	6.3x5.4	40
47		5x5.4	36	5x5.4	40	5x5.4	40	6.3x5.4	50
100		6.3x5.4	60	6.3x5.4	66	6.3x5.4	79	6.3x5.4	90
150		6.3x5.4	65	6.3x5.4	75	6.3x7.7	121	8x10	210
220		6.3x5.4	79	6.3x5.4	79	6.3x7.7	121	8x10	210
330		6.3x7.7	121	6.3x7.7	121	8x10	210	8x10	210
470		8x10	210	8x10	210	8x10	210	10x10	250
680		8x10	210	8x10	210	10x10	310	10x10	310
1000		8x10	230	10x10	350	10x10	410		
1500		10x10	410	10x10	410				

Cap (μF)	V	25		35		50	
	Item	D x L	R.C.	D x L	R.C.	D x L	R.C.
0.1						4x5.4	1.0
0.22						4x5.4	2.6
0.33						4x5.4	3.2
0.47						4x5.4	3.8
1						4x5.4	6.3
2.2						4x5.4	11
3.3						4x5.4	14
4.7		4x5.4	13	4x5.4	15	4x5.4	18
10		4x5.4	22	5x5.4	25	6.3x5.4	30
22		6.3x5.4	32	6.3x5.4	42	6.3x5.4	39
33		6.3x5.4	48	6.3x5.4	47	6.3x7.7	60
47		6.3x5.4	58	6.3x5.4	56	8x10	70
100		6.3x7.7	84	6.3x7.7	84	6.3x7.7	60
150		8x10	140	8x10	155	8x10	110
220		8x10	155	8x10	190	8x10	140
330		8x10	190	10x10	300	10x10	180
470		10x10	300			10x10	220

CK series

- Standard type of V-chip, 2000 hours, 105°C.
- Applicable to SMT process.
- RoHS Compliance.
- 105°C 2000hours V-Chip型標準品。
- 適用於SMT製程。



SPECIFICATIONS

Items 項目	Characteristics 特性							
Capacitance Tolerance 靜電容量誤差	± 20%(120Hz,20°C)							
Operating Temperature Range 適用溫度範圍	-55 ~ +105°C							
Rated Voltage Range 額定電壓範圍	6.3 ~ 50VDC							
Capacitance Range 靜電容量範圍	0.1 ~ 1000μF							
Leakage Current 洩漏電流	I ≤ 0.01CV or 3 (μA) , which is greater. (After 2 minutes application of DC rated voltage, at 20°C)							
Dissipation Factor 散逸因素(tan δ)	Measurement Frequency: 120Hz. Temperature: 20°C							
	Rated Voltage(V)	6.3	10	16	25	35	50	63~100
	tan δ(Max)	0.32	0.28	0.24	0.18	0.15	0.14	0.12
Low Temperature Stability 低溫特性 Impedance Ratio(Max) 阻抗比率(最大值)	Measurement Frequency: 120Hz.							
	Rated Voltage(V)	6.3	10	16	25	35	50	63~100
	Z(-25°C)/Z(20°C)	4	3	2	2	2	2	2
	Z(-55°C)/Z(20°C)	8	8	4	4	3	3	3
Load Life 負荷壽命	2000hours,with application of rated voltage at 105°C							
	Capacitance Change	Within ± 20% of Initial Value						
	tan δ	200% or less of Initial Specified Value						
	Leakage Current	Initial Specified Value or less						
Shelf Life 放置壽命	The following specifications shall be satisfied when the capacitors are restored to 20°C after exposing them for 1,000 hours 105°C without voltage applied. Before the measurement, the capacitor shall be preconditioned by applying voltage according to them 4.1 of JIS C5101-4.							
	Capacitance Change	Within ± 20% of Initial Value						
	tan δ	200% or less of Initial Specified Value						
	Leakage Current	Initial Specified Value or less						
Resistance to Soldering Heat 焊錫耐熱性	The capacitors shall be kept on the hot plate maintained at 250°C for 30 seconds. After removing from the hot plate and restored at room temperature they meet the characteristics requirements listed at right.					Capacitance Change	Within ± 10% of Initial Value	
						tan δ	Initial Specified Value	
						Leakage Current	Initial Specified Value or less	
Marking 標識	Black print on the case top							

Frequency Coefficient of Permissible Ripple Current

Frequency (Hz)	50	120	300	1K	≥ 10K
Coefficient	0.70	1.00	1.17	1.36	1.50

The endurance of capacitors is reduced with internal heating produced by ripple current at the rate of halving the lifetime with every 5°C rise. When long life performance is required in actual use , the rms ripple current has to be reduced.

CK series

DIMENSIONS(mm)

Chip Type

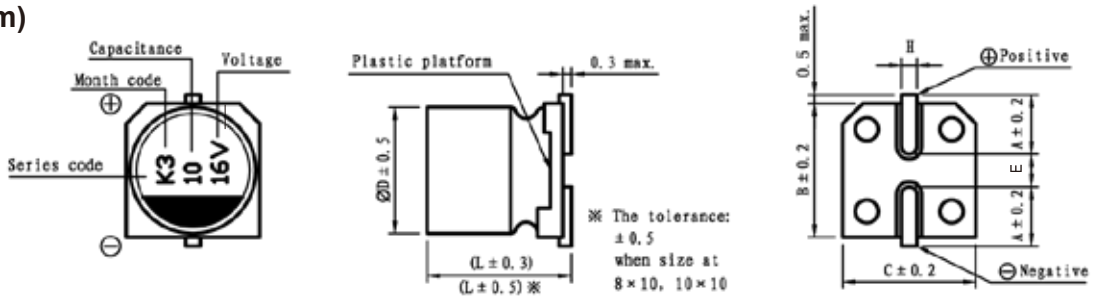

(mm)

ϕ D×L	4x5.4	5x5.4	6.3x5.4	6.3x7.7	8x10	10x10
A	1.8	2.1	2.4	2.4	2.9	3.2
B	4.3	5.3	6.6	6.6	8.3	10.3
C	4.3	5.3	6.6	6.6	8.3	10.3
E	1.0	1.3	2.2	2.2	3.1	4.5
L	5.4	5.4	5.4	7.7	10	10
H	0.5~0.8	0.5~0.8	0.5~0.8	0.5~0.8	0.8~1.1	0.8~1.1

CK

STANDARD RATINGS

D×L(mm) ; R.C.(mA rms) at 105°C 120Hz.

Cap (μF)	V	6.3		10		16		25		35		50	
	Item	D x L	R.C.	D x L	R.C.	D x L	R.C.	D x L	R.C.	D x L	R.C.	D x L	R.C.
0.1												4x5.4	1.0
0.22												4x5.4	2.6
0.33												4x5.4	3.2
0.47												4x5.4	3.8
1												4x5.4	8
2.2								4x5.4	6.6	4x5.4	8	4x5.4	11
3.3						4x5.4	7	4x5.4	12	4x5.4	13	4x5.4	16
4.7				4x5.4	7	4x5.4	9	4x5.4	13	4x5.4	15	5x5.4	19
10		4x5.4	10	4x5.4	13	4x5.4	28	5x5.4	28	5x5.4	28	6.3x5.4	35
22		4x5.4	26	5x5.4	35	5x5.4	39	6.3x5.4	45	6.3x5.4	70	6.3x7.7	65
33		4x5.4	29	6.3x5.4	43	6.3x5.4	51	6.3x5.4	65	6.3x5.4	70	8x10	140
47		5x5.4	45	6.3x5.4	62	6.3x5.4	70	6.3x5.4	70	6.3x7.7	80	8x10	170
100		6.3x5.4	71	6.3x5.4	90	6.3x7.7	100	6.3x7.7	100	8x10	305	8x10	315
220		6.3x7.7	100	6.3x7.7	120	6.3x7.7	125	8x10	355	10x10	450	10x10	450
330				8x10	215	10x10	440	10x10	450				
470		10x10	310	10x10	440	10x10	460	10x10	490				
1000		10x10	495										

CN series

- Non-polarity V-chip.
- Applicable to SMT process.
- RoHS Compliance.
- V-Chip 無極性產品。
- 適用於SMT製程。



SPECIFICATIONS

Items 項目	Characteristics 特性							
Capacitance Tolerance 靜電容量誤差	± 20%(120Hz,20°C)							
Operating Temperature Range 適用溫度範圍	-55 ~ +85°C							
Rated Voltage Range 額定電壓範圍	6.3 ~ 50VDC							
Capacitance Range 靜電容量範圍	0.1 ~ 100μF							
Leakage Current 洩漏電流	I ≤ 0.03CV or 5 (μA) , which is greater. (After 2 minutes application of DC rated voltage, at 20°C)							
Dissipation Factor 散逸因素(tan δ)	Measurement Frequency: 120Hz. Temperature: 20°C							
	Rated Voltage(V)	6.3	10	16	25	35	50	
	tan δ(Max)	0.30	0.25	0.20	0.17	0.15	0.15	
Low Temperature Stability 低溫特性	Measurement Frequency: 120Hz.							
	Rated Voltage(V)	6.3	10	16	25	35	50	
	Impedance Ratio(Max) 阻抗比率(最大值)	Z(-25°C)/Z(20°C)	4	3	2	2	2	2
	Z(-55°C)/Z(20°C)	8	6	4	4	3	3	
Load Life 負荷壽命	1000hours,with application of rated voltage at 85°C							
	Capacitance Change	Within ± 20% of Initial Value						
	tan δ	200% or less of Initial Specified Value						
	Leakage Current	Initial Specified Value or less						
Shelf Life 放置壽命	The following specifications shall be satisfied when the capacitors are restored to 20°C after exposing them for 1,000 hours 85°C without voltage applied. Before the measurement, the capacitor shall be preconditioned by applying voltage according to them 4.1 of JIS C5101-4.							
	Capacitance Change	Within ± 20% of Initial Value						
	tan δ	200% or less of Initial Specified Value						
	Leakage Current	Initial Specified Value or less						
Resistance to Soldering Heat 焊錫耐熱性	The capacitors shall be kept on the hot plate maintained at 250°C for 30 seconds. After removing from the hot plate and restored at room temperature they meet the characteristics requirements listed at right.				Capacitance Change	Within ± 10% of Initial Value		
					tan δ	Initial Specified Value		
					Leakage Current	Initial Specified Value or less		
Marking 標識	Black print on the case top							

Frequency Coefficient of Permissible Ripple Current

Frequency (Hz)	50	120	300	1K	≥ 10K
Coefficient	0.70	1.00	1.17	1.36	1.50

The endurance of capacitors is reduced with internal heating produced by ripple current at the rate of halving the lifetime with every 10°C rise. When long life performance is required in actual use , the rms ripple current has to be reduced.

CN series

DIMENSIONS(mm)

Chip Type

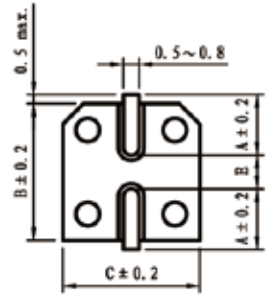
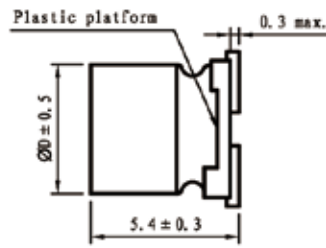
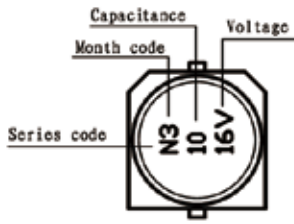

φ D×L	(mm)		
	4x5.4	5x5.4	6.3x5.4
A	1.8	2.1	2.4
B	4.3	5.3	6.6
C	4.3	5.3	6.6
E	1.0	1.3	2.2

STANDARD RATINGS

D×L(mm) ; R.C.(mA rms) at 85°C 120Hz.

Cap (μF)	V	6.3		10		16		25		35		50	
		Item	D x L	R.C.	D x L	R.C.	D x L	R.C.	D x L	R.C.	D x L	R.C.	D x L
0.1												4x5.4	1.0
0.22												4x5.4	2.0
0.33												4x5.4	2.8
0.47												4x5.4	4.0
1												4x5.4	8.4
2.2										4x5.4	8.4	5x5.4	13
3.3								5x5.4	12	5x5.4	16	5x5.4	17
4.7						4x5.4	12	5x5.4	16	5x5.4	18	6.3x5.4	20
10				4x5.4	17	5x5.4	23	6.3x5.4	27	6.3x5.4	29	6.3x5.4	40
22		4x5.4	28	4x5.4	33	5x5.4	37	6.3x5.4	50				
33		6.3x5.4	37	6.3x5.4	41	6.3x5.4	49						
47		6.3x5.4	45	6.3x5.4	54								
100		6.3x5.4	65										

CN

CD series

- Low impedance, 105°C V-chip.
- Applicable to SMT process.
- RoHS Compliance.
- 105°C低阻抗、V-Chip型產品。
- 適用於SMT製程。



SPECIFICATIONS

Items 項目	Characteristics 特性										
Capacitance Tolerance 靜電容量誤差	± 20%(120Hz,20°C)										
Operating Temperature Range 適用溫度範圍	-55 ~ +105°C										
Rated Voltage Range 額定電壓範圍	6.3 ~ 100VDC										
Capacitance Range 靜電容量範圍	1 ~ 1500μF										
Leakage Current 洩漏電流	I ≤ 0.01CV or 3(μA) , which is greater. (After 2 minutes application of DC rated voltage, at 20°C)										
Dissipation Factor 散逸因素(tan δ)	Measurement Frequency: 120Hz. Temperature: 20°C										
	Rated Voltage(V)	6.3	10	16	25	35	50	63	80	100	
	tan δ(Max)	0.30	0.26	0.22	0.16	0.13	0.10	0.08	0.08	0.07	
Low Temperature Stability 低溫特性	Measurement Frequency: 120Hz.										
	Rated Voltage(V)	6.3	10	16	25	35	50	63	80	100	
	Impedance Ratio(Max) 阻抗比率(最大值)	Z(-25°C)/Z(20°C)	4	3	2	2	2	2	2	2	2
	Z(-55°C)/Z(20°C)	8	5	4	3	3	3	3	3	3	
Load Life 負荷壽命	3000hours,with application of rated voltage 105°C(L < 10mm : 2000hrs)										
	Capacitance Change	Within ± 30% of Initial Value									
	tan δ	300% or less of Initial Specified Value									
	Leakage Current	Initial Specified Value or less									
Shelf Life 放置壽命	The following specifications shall be satisfied when the capacitors are restored to 20°C after exposing them for 1,000 hours 105°C without voltage applied. Before the measurement, the capacitor shall be preconditioned by applying voltage according to them 4.1 of JIS C5101-4.										
	Capacitance Change	Within ± 30% of Initial Value									
	tan δ	300% or less of Initial Specified Value									
	Leakage Current	Initial Specified Value or less									
Resistance to Soldering Heat 焊錫耐熱性	The capacitors shall be kept on the hot plate maintained at 250°C for 30 seconds. After removing from the hot plate and restored at room temperature they meet the characteristics requirements listed at right.					Capacitance Change	Within ± 10% of Initial Value				
						tan δ	Initial Specified Value				
						Leakage Current	Initial Specified Value or less				
Marking 標識	Black print on the case top										

Frequency Coefficient of Permissible Ripple Current

Frequency (Hz)	120 ≤ F < 1K	1K ≤ F < 10K	10K ≤ F < 100K	100K ≤ F
≤ 33	0.35	0.70	0.90	1.00
33 ~ 150	0.40	0.85	0.92	1.00
> 150	0.60	0.85	0.95	1.00

The endurance of capacitors is reduced with internal heating produced by ripple current at the rate of halving the lifetime with every 5°C rise. When long life performance is required in actual use , the rms ripple current has to be reduced.

CD series

DIMENSIONS(mm)

Chip Type

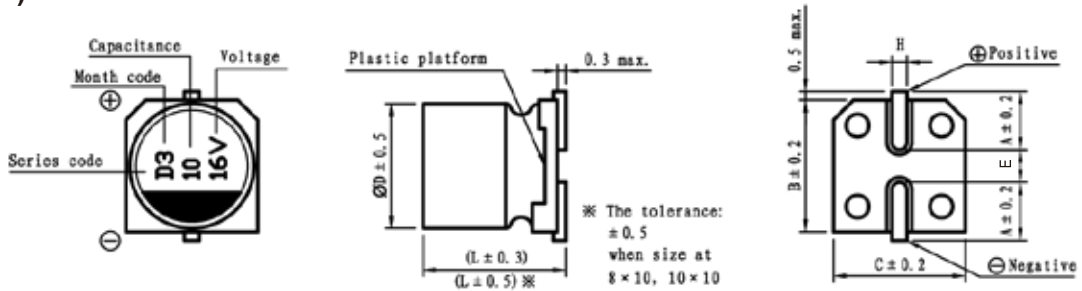

(mm)

ϕ D x L	4x5.4	5x5.4	6.3x5.4	6.3x6.0	6.3x7.7	8x6.5	8x10	10x10
A	1.8	2.1	2.4	2.4	2.4	3.3	2.9	3.2
B	4.3	5.3	6.6	6.6	6.6	8.3	8.3	10.3
C	4.3	5.3	6.6	6.6	6.6	8.3	8.3	10.3
E	1.0	1.3	2.2	2.2	2.2	2.3	3.1	4.5
L	5.4	5.4	5.4	6.0	7.7	6.5	10	10
H	0.5~0.8	0.5~0.8	0.5~0.8	0.5~0.8	0.5~0.8	0.5~0.8	0.8~1.1	0.8~1.1

STANDARD RATINGS

D x L (mm) ; R.C. (mA rms) at 105°C 100KHz, IMP (Ω max) at 20°C 100KHz.

Cap (μ F)	V	6.3			10			16			25			35		
		Item	D x L	R.C.	IMP	D x L	R.C.	IMP	D x L	R.C.	IMP	D x L	R.C.	IMP	D x L	R.C.
4.7														4x5.4	80	2.0
10								4x5.4	80	2.0	4x5.4	80	2.0	5x5.4	150	1.20
22		4x5.4	80	2.0	4x5.4	80	2.0	5x5.4	150	1.20	5x5.4	150	1.20	6.3x5.4	230	0.80
33		4x5.4	80	2.0	5x5.4	150	1.20	5x5.4	150	1.20	6.3x5.4	230	0.80	6.3x5.4	230	0.80
47		5x5.4	150	1.20	5x5.4	150	1.20	5x5.4	150	1.20	6.3x5.4	230	0.80	6.3x5.4	230	0.80
100		6.3x5.4	230	0.80	6.3x5.4	230	0.80	6.3x5.4	230	0.80	6.3x7.7	280	0.58	8x10	450	0.22
150		6.3x5.4	230	0.80	6.3x5.4	230	0.80	6.3x7.7	280	0.58	8x10	450	0.22	8x10	450	0.22
220		6.3x5.4	230	0.80	6.3x7.7	280	0.58	6.3x7.7	280	0.58	8x10	450	0.22	10x10	670	0.15
330		8x10	450	0.22	8x10	450	0.22	8x10	450	0.22	8x10	450	0.22			
470		8x10	450	0.22	8x10	450	0.22	8x10	450	0.22	10x10	670	0.15			
								10x10	670	0.15						
680		8x10	450	0.22	10x10	670	0.15	10x10	670	0.15						
1000		8x10	450	0.22	10x10	670	0.15									
1500		10x10	670	0.15												

Cap (μ F)	V	50			63			80			100		
		Item	D x L	R.C.	IMP	D x L	R.C.	IMP	D x L	R.C.	IMP	D x L	R.C.
1		4x5.4	60	9.0									
2.2		4x5.4	60	9.0									
3.3		4x5.4	60	9.0	5x5.4	85	5.0	5x5.4	50	5.3			
4.7		5x5.4	85	5.0	5x5.4	85	5.0	6.3x5.4	60	4.8			
10		6.3x5.4	165	2.2	6.3x5.4	165	2.2				8x10	130	1.88
22		6.3x5.4	165	2.2	6.3x7.7	185	1.4	8x10	130	1.88	10x10	200	0.90
33		6.3x7.7	185	1.4	8x10	369	0.85	10x10	200	0.90	10x10	200	0.90
47		6.3x7.7	185	1.4	8x10	369	0.85	10x10	200	0.90	10x10	200	0.90
68		8x10	369	0.68	10x10	450	0.48	10x10	200	0.90			
100		8x10	369	0.68	10x10	553	0.48						
		10x10	553	0.48									
150		10x10	553	0.48									

CG series

- Wide range of -55~+125°C, long life product.
- Applicable to SMT process.
- RoHS Compliance.
- -55 ~ +125°C廣溫度、長壽命產品。
- 適用於SMT製程。



SPECIFICATIONS

Items 項目	Characteristics 特性									
Capacitance Tolerance 靜電容量誤差	± 20%(120Hz,20°C)									
Operating Temperature Range 適用溫度範圍	-55 ~ +125°C					-40 ~ +125°C				
Rated Voltage Range 額定電壓範圍	10 ~ 63VDC					80 ~ 160VDC				
Capacitance Range 靜電容量範圍	10 ~ 470µF					2.2 ~ 4.7µF				
Leakage Current 洩漏電流	I ≤ 0.01CV or 3(µA) , which is greater. (After 2 minutes application of DC rated voltage, at 20°C)									
Dissipation Factor 散逸因素(tan δ)	Measurement Frequency: 120Hz. Temperature: 20°C									
	Rated Voltage(V)	10	16	25	35	50	63	80	100	160
	tan δ(Max)	0.32	0.24	0.21	0.18	0.18	0.15	0.15	0.12	0.20
Low Temperature Stability 低溫特性 Impedance Ratio(Max) 阻抗比率(最大值)	Measurement Frequency: 120Hz.									
	Rated Voltage(V)	10	16	25	35	50	63	80	100	160
	Z(-25°C)/Z(20°C)	3	2	2	2	2	2	2	2	-
	Z(-40°C)/Z(20°C)	-	-	-	-	-	-	3	3	-
	Z(-55°C)/Z(20°C)	6	4	4	3	3	3	-	-	-
Load Life 負荷壽命	3000hours,with application of rated voltage at 125°C (ØD=4~6.3x5.4mm : 1000hrs;6.3x7.7mm : 2000hrs)									
	Capacitance Change	Within ± 30% of Initial Value								
	tan δ	300% or less of Initial Specified Value								
	Leakage Current	Initial Specified Value or less								
Shelf Life 放置壽命	The following specifications shall be satisfied when the capacitors are restored to 20°C after exposing them for 1,000 hours 125°C without voltage applied. Before the measurement, the capacitor shall be preconditioned by applying voltage according to them 4.1 of JIS C5101-4.									
	Capacitance Change	Within ± 30% of Initial Value								
	tan δ	300% or less of Initial Specified Value								
	Leakage Current	500% or less of Initial Specified Value								
Resistance to Soldering Heat 焊錫耐熱性	The capacitors shall be kept on the hot plate maintained at 250°C for 30 seconds. After removing from the hot plate and restored at room temperature they meet the characteristics requirements listed at right.					Capacitance Change	Within ± 10% of Initial Value			
						tan δ	Initial Specified Value			
						Leakage Current	Initial Specified Value or less			
Marking 標識	Black print on the case top									

Frequency Coefficient of Permissible Ripple Current

Frequency (Hz)	50	60	120	1K	≧10K
Coefficient	0.64	0.64	1.00	1.36	1.50

The endurance of capacitors is reduced with internal heating produced by ripple current at the rate of halving the lifetime with every 5°C rise. When long life performance is required in actual use , the rms ripple current has to be reduced.

CG series

DIMENSIONS(mm)

Chip Type

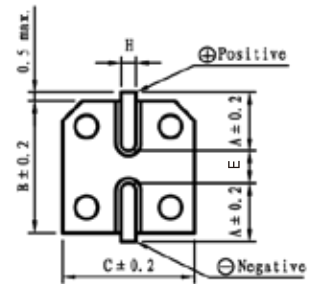
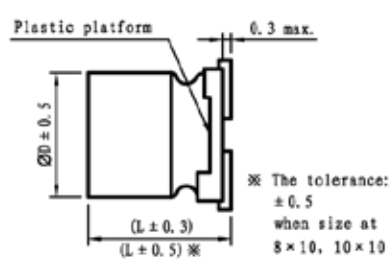
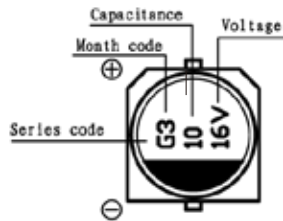

(mm)

ψ D×L	6.3x5.4	6.3x7.7	8x10	10x10
A	2.4	2.4	2.9	3.2
B	6.6	6.6	8.3	10.3
C	6.6	6.6	8.3	10.3
E	2.2	2.2	3.1	4.5
L	5.4	7.7	10	10
H	0.5~0.8	0.5~0.8	0.8~1.1	0.8~1.1

STANDARD RATINGS

D×L(mm) ; R.C.(mA rms) at 125°C 120Hz.

Cap (μF)	V	10		16		25		35		50	
	Item	D x L	R.C.	D x L	R.C.	D x L	R.C.	D x L	R.C.	D x L	R.C.
10								6.3x5.4	46	6.3x7.7	34
22								6.3x5.4	46	6.3x7.7	55
33						6.3x5.4	46	6.3x7.7	73	8x10	106
47				6.3x5.4	40	6.3x7.7	73	6.3x7.7	73	8x10	106
										10x10	164
100	6.3x7.7	58		6.3x7.7	73	6.3x7.7	73	8x10	131	10x10	164
						8x10	131	10x10	164		
220	6.3x7.7	58		8x10	131	8x10	131	10x10	164		
				10x10	164	10x10	164				
330	8x10	90		10x10	164	10x10	164				
	10x10	112									
470	10x10	130									

Cap (μF)	V	63		80		100		160	
	Item	D x L	R.C.	D x L	R.C.	D x L	R.C.	D x L	R.C.
2.2								8x10	22
3.3								8x10	22
4.7								10x10	70
10	6.3x7.7	40		8x10	46	8x10	46		
22	8x10	66		8x10	46	8x10	46		
				10x10	76	10x10	76		
33	8x10	66		8x10	46	10x10	76		
	10x10	113		10x10	76				
47	8x10	66							
	10x10	113							

CL series

- 105°C 2000hours Life.
- Suitable for lighting and power charger.
- RoHS Compliance.
- 105°C 2000hours產品。
- 適用於照明設備及電源充電器。



SPECIFICATIONS

Items 項目	Characteristics 特性				
Capacitance Tolerance 靜電容量誤差	± 20%(120Hz,20°C)				
Operating Temperature Range 適用溫度範圍	-40 ~ +105°C				
Rated Voltage Range 額定電壓範圍	160~400VDC				
Capacitance Range 靜電容量範圍	2.2 ~ 82μF				
Leakage Current 洩漏電流	$I \leq 0.04CV + 100(\mu A)$ (After 2 minutes application of DC rated voltage, at 20°C)				
Dissipation Factor 散逸因素(tan δ)	Measurement Frequency: 120Hz. Temperature: 20°C				
	Rated Voltage(V)	160~250			400
	tan δ(Max)	0.2			0.25
Low Temperature Stability 低溫特性 Impedance Ratio(Max) 阻抗比率(最大值)	Measurement Frequency: 120Hz.				
	Rated Voltage(V)	160	200	250	400
	Z(-25°C)/Z(20°C)	3	3	3	6
	Z(-40°C)/Z(20°C)	6	6	6	10
Load Life 負荷壽命	2000hours,with application of rated voltage at 105°C				
	Capacitance Change	Within ± 20% of Initial Value			
	tan δ	200% or less of Initial Specified Value			
	Leakage Current	Initial Specified Value or less			
Shelf Life 放置壽命	The following specifications shall be satisfied when the capacitors are restored to 20°C after exposing them for 500 hours 105°C without voltage applied. Before the measurement, the capacitor shall be preconditioned by applying voltage according to them 4.1 of JIS C5101-4.				
	Capacitance Change	Within ± 20% of Initial Value			
	tan δ	200% or less of Initial Specified Value			
	Leakage Current	Initial Specified Value or less			
Resistance to Soldering Heat 焊錫耐熱性	The capacitors shall be kept on the hot plate maintained at 250°C for 30 seconds. After removing from the hot plate and restored at room temperature they meet the characteristics requirements listed at right.			Capacitance Change	Within ± 10% of Initial Value
				tan δ	Initial Specified Value
				Leakage Current	Initial Specified Value or less
Marking 標識	JIS C 5101-4-1 (IEC 60384)				

Frequency Coefficient of Permissible Ripple Current

Frequency (Hz)	50	120	300	1K	≥10K
Capacitance (μF)					
2.2 ~ 6.8	0.70	1.00	1.17	1.36	1.50

The endurance of capacitors is reduced with internal heating produced by ripple current at the rate of halving the lifetime with every 5°C rise. When long life performance is required in actual use , the rms ripple current has to be reduced.

CL series

DIMENSIONS(mm)

Chip Type

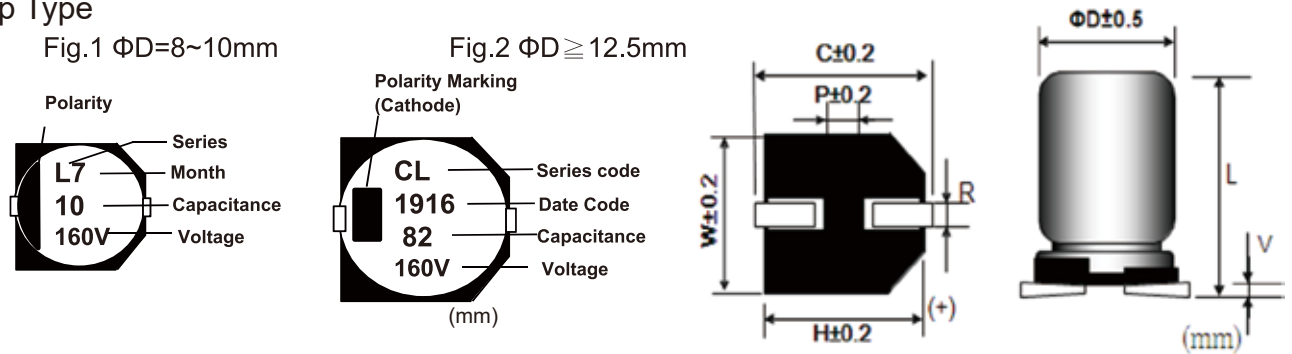

(mm)

Size	ΦD	$L \pm 0.5$	W	H	C	R	P	Vmax
8x10	8.0	10.5	8.3	8.3	9.0	0.7~1.1	3.1	0.3
10x10	10.0	10.5	10.3	10.3	11.0	1.0~1.3	4.5	0.3
12.5x13.5	12.5	13.5	13.0	13.0	13.7	1.1~1.4	4.5	0.4
16x16.5	16.0	16.5	17.0	17.0	18.0	1.4~1.8	7.0	0.4

STANDARD RATINGS

DxL(mm) ; R.C.(mA rms) at 105°C 120Hz.

Cap (μF)	V	160		200		250		400	
		Item	D x L	R.C.	DxL	R.C.	D x L	R.C.	D x L
2.2								8x10.5	25
3.3						8x10.5	31	10x10.5	36
4.7						8x10.5	37	10x10.5	38
6.8						8x10.5	44	12.5x13.5	47
10		8x10.5	57	10x10.5	64	10x10.5	64	12.5x13.5	57
22		12.5x13.5	112	12.5x13.5	112	12.5x13.5	112	16x16.5	115
33		12.5x13.5	137	12.5x13.5	137	16x16.5	150		
47		16x16.5	180	16x16.5	180	16x16.5	180		
68		16x16.5	215	16x16.5	215				
82		16x16.5	235						

CKL series

- 105°C 5000 hours Long Life.
- Applicable to SMT process.
- RoHS Compliance.
- 105°C 5000hour長壽命產品。
- 適用於SMT製程。



SPECIFICATIONS

Items 項目	Characteristics 特性							
Capacitance Tolerance 靜電容量誤差	± 20%(120Hz,20°C)							
Operating Temperature Range 適用溫度範圍	-40 ~ +105°C							
Rated Voltage Range 額定電壓範圍	6.3 ~ 50VDC							
Capacitance Range 靜電容量範圍	22 ~ 1000μF							
Leakage Current 洩漏電流	I ≤ 0.01CV or 3 (μA) , which is greater. (After 2 minutes application of DC rated voltage, at 20°C)							
Dissipation Factor 散逸因素(tan δ)	Measurement Frequency: 120Hz. Temperature: 20°C							
	Rated Voltage(V)	6.3	10	16	25	35	50	
	tan δ(Max)	0.32	0.28	0.22	0.16	0.13	0.12	
Low Temperature Stability 低溫特性	Measurement Frequency: 120Hz.							
	Rated Voltage(V)	6.3	10	16	25	35	50	
	Impedance Ratio(Max) 阻抗比率(最大值)	Z(-25°C)/Z(20°C)	4	3	2	2	2	2
	Z(-40°C)/Z(20°C)	10	7	5	3	3	3	
Load Life 負荷壽命	5000hours,with application of rated voltage at 105°C							
	Capacitance Change	Within ± 30% of Initial Value						
	tan δ	300% or less of Initial Specified Value						
	Leakage Current	Initial Specified Value or less						
Shelf Life 放置壽命	The following specifications shall be satisfied when the capacitors are restored to 20°C after exposing them for 1,000 hours 105°C without voltage applied. Before the measurement, the capacitor shall be preconditioned by applying voltage according to them 4.1 of JIS C5101-4.							
	Capacitance Change	Within ± 30% of Initial Value						
	tan δ	300% or less of Initial Specified Value						
	Leakage Current	Initial Specified Value or less						
Resistance to Soldering Heat 焊錫耐熱性	The capacitors shall be kept on the hot plate maintained at 250°C for 30 seconds. After removing from the hot plate and restored at room temperature they meet the characteristics requirements listed at right.				Capacitance Change	Within ± 10% of Initial Value		
					tan δ	Initial Specified Value		
					Leakage Current	Initial Specified Value or less		
Standards 參照標準	JIS C 5101-4-1 (IEC 60384)							

Frequency Coefficient of Permissible Ripple Current

Frequency (Hz)	100 ≤ F < 1K	1K ≤ F < 10K	10K ≤ F < 100K	100K ≤ F
Capacitance (μF)				
4.7 ~ 33	1.00	1.20	1.30	1.45
>33	1.00	1.10	1.20	1.30

The endurance of capacitors is reduced with internal heating produced by ripple current at the rate of halving the lifetime with every 5°C rise. When long life performance is required in actual use , the rms ripple current has to be reduced.

CKL series

DIMENSIONS(mm)

Chip Type

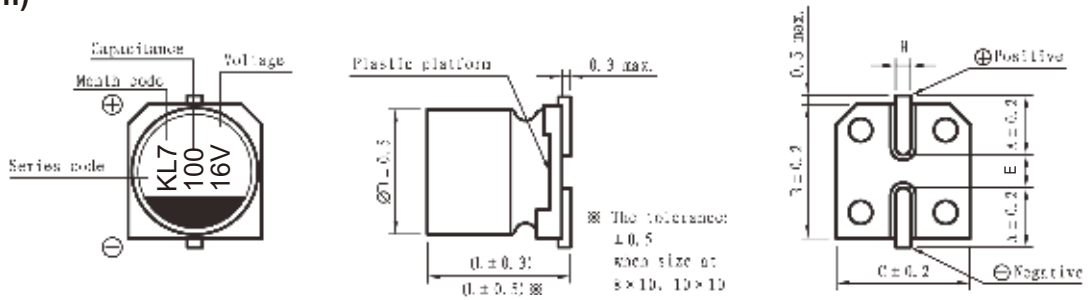

CKL

	(mm)	
ϕ D×L	8x10	10x10
A	2.9	3.2
B	8.3	10.3
C	8.3	10.3
E	3.1	4.5
L	10	10
H	0.8~1.1	0.8~1.1

STANDARD RATINGS

D×L(mm) : R.C.(mA rms) at 105°C 120Hz

Cap (μF)	V	6.3		10		16		25		35		50	
	Item	D x L	R.C.	D x L	R.C.	D x L	R.C.	D x L	R.C.	D x L	R.C.	D x L	R.C.
22													
33												8x10	80
47										8x10	92	8x10	95
100								8x10	116	10x10	150	10x10	160
220				8x10	140	10x10	216	10x10	240	10x10	280		
330	8x10	160	10x10	240	10x10	300	10x10	375					
470	10x10	260	10x10	280	10x10	320							
1000	10x10	340											

CDL series

- Low impedance, 105°C 5000 hour.
- Applicable to SMT process.
- RoHS Compliance.
- 105°C低阻抗、5000hours長壽命產品。
- 適用於SMT製程。



SPECIFICATIONS

Items 項目	Characteristics 特性										
Capacitance Tolerance 靜電容量誤差	± 20%(120Hz,20°C)										
Operating Temperature Range 適用溫度範圍	-55 ~ +105°C										
Rated Voltage Range 額定電壓範圍	6.3~100VDC										
Capacitance Range 靜電容量範圍	22~1500µF										
Leakage Current 洩漏電流	I ≤ 0.01CV or 3 (µA), which is greater. (After 2 minutes application of DC rated voltage, at 20°C)										
Dissipation Factor 散逸因素(tan δ)	Measurement Frequency: 120Hz. Temperature: 20°C										
	Rated Voltage(V)	6.3	10	16	25	35	50	63	80	100	
	tan δ(Max)	0.3	0.26	0.22	0.16	0.14	0.14	0.08	0.08	0.07	
Low Temperature Stability 低溫特性 Impedance Ratio(Max) 阻抗比率(最大值)	Measurement Frequency: 120Hz.										
	Rated Voltage(V)	6.3	10	16	25	35	50	63	80	100	
	Z(-25°C)/Z(20°C)	4	3	2	2	2	2	2	2	2	
	Z(-55°C)/Z(20°C)	8	5	4	3	3	3	3	3	3	
Load Life 負荷壽命	5000hours,with application of rated voltage at 105°C										
	Capacitance Change	Within ±30% of Initial Value									
	tan δ	300% or less of Initial Specified Value									
	Leakage Current	Initial Specified Value or less									
Shelf Life 放置壽命	The following specifications shall be satisfied when the capacitors are restored to 20°C after exposing them for 1000 hours 105°C without voltage applied. Before the measurement, the capacitor shall be preconditioned by applying voltage according to them 4.1 of JIS C5101-4.										
	Capacitance Change	Within ±30% of Initial Value									
	tan δ	300% or less of Initial Specified Value									
	Leakage Current	Initial Specified Value or less									
Resistance to Soldering Heat 焊錫耐熱性	The capacitors shall be kept on the hot plate maintained at 250°C for 30 seconds. After removing from the hot plate and restored at room temperature they meet the characteristics requirements listed at right.							Capacitance Change	Within ± 10% of Initial Value		
								tan δ	Initial Specified Value		
								Leakage Current	Initial Specified Value or less		
Standards 參照標準	JIS C 5101-4-1 (IEC 60384)										

Frequency Coefficient of Permissible Ripple Current

Frequency (Hz)	120 ≤ F < 1K	1K ≤ F < 10K	10K ≤ F < 100K	100K ≤ F
≤ 33	0.35	0.70	0.90	1.00
33 ~ 150	0.40	0.85	0.92	1.00
> 150	0.60	0.85	0.95	1.00

The endurance of capacitors is reduced with internal heating produced by ripple current at the rate of halving the lifetime with every 5°C rise. When long life performance is required in actual use , the rms ripple current has to be reduced.

CDL

CDL series

DIMENSIONS(mm)

Chip Type

Fig.1 $\varnothing D=8\sim 10\text{mm}$

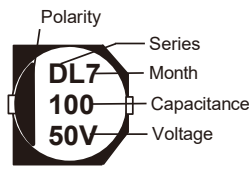
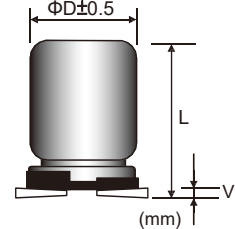
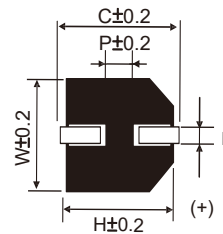
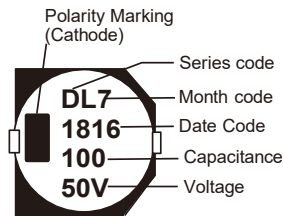

Fig.2 $\varnothing D \geq 12.5\text{mm}$



(mm)

Size	$\varnothing D$	$L \pm 0.5$	W	H	C	R	P	Vmax
8x10	8.0	10.0	8.3	8.3	9.0	0.7~1.1	3.2	0.3
10x10	10.0	10.0	10.3	10.3	11.0	0.7~1.3	4.5	0.3
12.5x13.5	12.5	13.5	13.0	13.0	13.7	1.1~1.4	4.5	0.4
16x16.5	16.0	16.5	17.0	17.0	18.0	1.4~1.8	6.4	0.4

CDL

STANDARD RATINGS

DxL(mm) ; R.C.(mA rms) at 105°C 100KHz, IMP(Ω max) at 20°C 100KHz.

Cap (μF)	V	6.3			10			16			25			35				
		Item	D x L	R.C.	IMP	D x L	R.C.	IMP	D x L	R.C.	IMP	D x L	R.C.	IMP	D x L	R.C.	IMP	
100																		
150											8x10	600	0.17	8x10	600	0.17		
220											8x10	600	0.17	10x10	850	0.09		
330					8x10	600	0.17	8x10	600	0.17	8x10	600	0.17					
470	8x10	600	0.17	8x10	600	0.17	8x10	600	0.17	10x10	850	0.09	12.5x13.5	1100	0.06			
680	8x10	600	0.17	10x10	850	0.09	10x10	850	0.09	12.5x13.5	1100	0.06	12.5x13.5	1100	0.06			
1000	8x10	600	0.17	10x10	850	0.09	10x10	850	0.09	12.5x13.5	1100	0.06	16x16.5	1800	0.035			
								12.5x13.5	1100	0.06	12.5x13.5	1100	0.06	16x16.5	1800	0.035		
1500	10x10	850	0.09	12.5x13.5	1100	0.06	12.5x13.5	1100	0.06	16x16.5	1800	0.035	16x16.5	1800	0.035			
2200	12.5x13.5	1100	0.06	12.5x13.5	1100	0.06				16x16.5	1800	0.035						
3300								16x16.5	1800	0.035								
4700				16x16.5	1800	0.035												
6800	16x16.5	1800	0.035															

Cap (μF)	V	50			63			80			100						
		Item	D x L	R.C.	IMP	D x L	R.C.	IMP	D x L	R.C.	IMP	D x L	R.C.	IMP			
22											8x10	130	1.88				
33								8x10	130	1.88	10x10	200	0.65				
47					8x10	200	0.70	10x10	200	0.90	12.5x13.5	500	0.32				
56	8x10	330	0.34	10x10	369	0.48											
68	8x10	330	0.34								12.5x13.5	500	0.32				
100	8x10	330	0.34	12.5x13.5	800	0.16	12.5x13.5	500	0.32	16x16.5	793	0.17					
150	10x10	670	0.18	12.5x13.5	800	0.16	12.5x13.5	500	0.32	16x16.5	793	0.17					
220	10x10	670	0.18	12.5x13.5	800	0.16											
330	12.5x13.5	900	0.12	16x16.5	1410	0.082	16x16.5	793	0.17								
470	16x16.5	1610	0.073	16x16.5	1410	0.082											
680	16x16.5	1610	0.073														
1000	16x16.5	1610	0.073														

CGL series

- Low impedance, 125°C 3000 hours Long Life.
- Applicable to SMT process.
- RoHS Compliance.
- 125°C低阻抗、3000hours長壽命產品。
- 適用於SMT製程。



SPECIFICATIONS

Items 項目	Characteristics 特性				
Capacitance Tolerance 靜電容量誤差	± 20%(120Hz,20°C)				
Operating Temperature Range 適用溫度範圍	-40 ~ +125°C				
Rated Voltage Range 額定電壓範圍	16~50VDC				
Capacitance Range 靜電容量範圍	33~330μF				
Leakage Current 洩漏電流	I ≤ 0.01CV or 3 (μA), which is greater. (After 2 minutes application of DC rated voltage, at 20°C)				
Dissipation Factor 散逸因素(tan δ)	Measurement Frequency: 120Hz. Temperature: 20°C				
	Rated Voltage(V)	16	25	35	50
	tan δ(Max)	0.23	0.18	0.16	0.14
Low Temperature Stability 低溫特性 Impedance Ratio(Max) 阻抗比率(最大值)	Measurement Frequency: 120Hz.				
	Rated Voltage(V)	16	25	35	50
	Z(-25°C)/Z(20°C)	3	3	2	2
	Z(-40°C)/Z(20°C)	4	4	3	3
Load Life 負荷壽命	3000hours,with application of rated voltage at 125°C				
	Capacitance Change	Within ±30% of Initial Value			
	tan δ	300% or less of Initial Specified Value			
	Leakage Current	Initial Specified Value or less			
Shelf Life 放置壽命	The following specifications shall be satisfied when the capacitors are restored to 20°C after exposing them for 1000 hours 125°C without voltage applied. Before the measurement, the capacitor shall be preconditioned by applying voltage according to them 4.1 of JIS C5101-4.				
	Capacitance Change	Within ±30% of Initial Value			
	tan δ	300% or less of Initial Specified Value			
	Leakage Current	Initial Specified Value or less			
Resistance to Soldering Heat 焊錫耐熱性	The capacitors shall be kept on the hot plate maintained at 250°C for 30 seconds. After removing from the hot plate and restored at room temperature they meet the characteristics requirements listed at right.			Capacitance Change	Within ± 10% of Initial Value
				tan δ	Initial Specified Value
				Leakage Current	Initial Specified Value or less
Standards 參照標準	JIS C 5101-4-1 (IEC 60384)				

Frequency Coefficient of Permissible Ripple Current

Frequency (Hz)	120 ≤ F < 1K	1K ≤ F < 10K	10K ≤ F < 100K	100K ≤ F
Capacitance (μF)				
33~330	0.4	0.75	0.9	1.00

The endurance of capacitors is reduced with internal heating produced by ripple current at the rate of halving the lifetime with every 5°C rise. When long life performance is required in actual use , the rms ripple current has to be reduced.

CGL series

DIMENSIONS(mm)

Chip Type

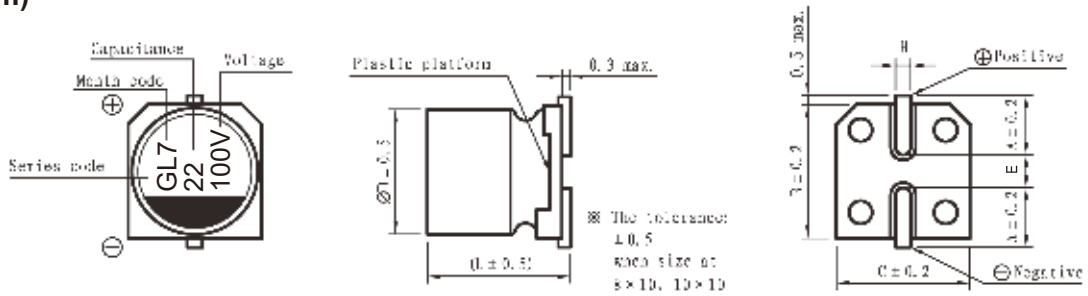

(mm)

ϕ D×L	8x10	10x10
A	2.9	3.2
B	8.3	10.3
C	8.3	10.3
E	3.1	4.5
L	10	10
H	0.8~1.1	0.8~1.1

CGL

STANDARD RATINGS

D×L(mm) ; R.C.(mA rms) at 125°C 100KHz, ESR (Ω max)

Cap (μ F)	V	16				25				35				50				
		Item	D x L	R.C.	ESR		D x L	R.C.	ESR		D x L	R.C.	ESR		D x L	R.C.	ESR	
					20°C	-40°C			20°C	-40°C			20°C	-40°C			20°C	-40°C
33														8x10	250	0.36	4.5	
47														8x10	250	0.36	4.5	
									8x10	300	0.30	4.5	10x10	350	0.25	3		
100									8x10	300	0.30	4.5	10x10	350	0.25	3		
		8x10	300	0.30	4.5	8x10	300	0.30	4.5	10x10	500	0.20	3					
220		8x10	300	0.30	4.5	8x10	300	0.30	4.5	10x10	500	0.20	3					
		10x10	500	0.20	3	10x10	500	0.20	3									
330		10x10	500	0.20	3	10x10	500	0.20	3									

CGS series

- Chip type with 6.3Ø~16Ø, 125°C, 2,000 hours, long life product.
- Designed For automobile modules and other high temperature applications.
- RoHS Compliance.
- 6.3Ø~16ØV-Chip型, 125°C, 2,000小時長壽命產品。
- 專為汽車模組和其它高溫應用設計。



SPECIFICATIONS

Items 項目	Characteristics 特性									
Capacitance Tolerance 靜電容量誤差	± 20%(120Hz,20°C)									
Operating Temperature Range 適用溫度範圍	-55 ~ +125°C									
Rated Voltage Range 額定電壓範圍	6.3 ~ 100VDC									
Capacitance Range 靜電容量範圍	1 ~ 4700µF									
Leakage Current 洩漏電流	$I \leq 0.01CV$ or $3(\mu A)$, which is greater. (After 3 minutes application of DC rated voltage, at 20°C)									
Dissipation Factor 散逸因素(tan δ)	Measurement Frequency: 120Hz. Temperature: 20°C									
	Rated Voltage(V)	6.3	10	16	25	35	50	63	100	
	tan δ(Max)	0.30	0.24	0.20	0.16	0.14	0.14	0.12	0.10	
Low Temperature Stability 低溫特性 Impedance Ratio(Max) 阻抗比率(最大值)	Measurement Frequency: 120Hz.									
	Rated Voltage(V)	6.3	10	16	25	35	50	63	100	
	Z(-25°C)/Z(20°C)	4	3	2	2	2	2	2	2	2
	Z(-40°C)/Z(20°C)	8	6	4	3	3	3	3	3	3
Load Life 負荷壽命	6.3V~50V:2,000hours (ΦD =6.3mm1,000hours);63V~100V:1,500 hours with application of rated voltage at 125°C									
	Capacitance Change	within ±30% of Initial Value								
	tan δ	300% or less of Initial Specified Value								
	Leakage Current	Initial Specified Value or less								
Shelf Life 放置壽命	The following specifications shall be satisfied when the capacitors are restored to 20°C after exposing them for 1,000 hours 125°C without voltage applied. Before the measurement, the capacitor shall be preconditioned by applying voltage according to them 4.1 of JIS C5101-4.									
	Capacitance Change	Within ± 30% of Initial Value								
	tan δ	300% or less of Initial Specified Value								
	Leakage Current	Initial Specified Value or less								
Resistance to Soldering Heat 焊錫耐熱性	The capacitors shall be kept on the hot plate maintained at 250°C for 30 seconds. After removing from the hot plate and restored at room temperature they meet the characteristics requirements listed at right.					Capacitance Change	Within ± 10% of Initial Value			
						tan δ	Initial Specified Value			
						Leakage Current	Initial Specified Value or less			
Standards 參照標準	Black print on the case top									

Frequency Coefficient of Permissible Ripple Current

Frequency (Hz)	100 ≤ F < 1K	1K ≤ F < 10K	10K ≤ F < 100K	100K ≤ F
Capacitance (µF)				
C ≤ 22	0.50	0.80	0.90	1.00
22 < C ≤ 150	0.65	0.85	0.92	1.00
150 < C	0.70	0.85	0.95	1.00

The endurance of capacitors is reduced with internal heating produced by ripple current at the rate of halving the lifetime with every 5°C rise. When long life performance is required in actual use, the rms ripple current has to be reduced.

CGS

CGS series

DIMENSIONS(mm)

Chip Type

Fig.1 ØD=6~10mm

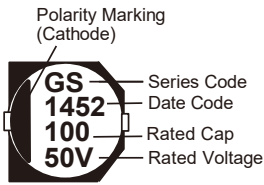
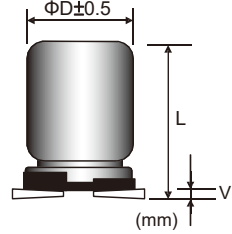
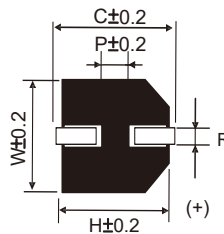
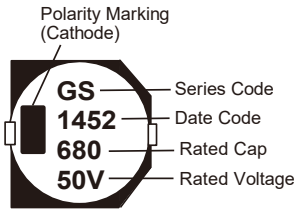

Fig.2 ØD ≥ 12.5mm



Size	ØD	L±0.5	W	H	C	R	P	Vmax
6.3×6	6.3	6.0	6.6	6.6	7.3	0.5~0.8	2.1	0.3
6.3×7.7	6.3	7.7	6.6	6.6	7.3	0.5~0.8	2.1	0.3
8×10	8.0	10.0	8.3	8.3	9.0	0.7~1.1	3.2	0.3
10×10	10.0	10.0	10.3	10.3	11.0	0.7~1.3	4.5	0.3
12.5×13.5	12.5	13.5	13.0	13.0	13.7	1.1~1.4	4.5	0.4
16×16.5	16.0	16.5	17.0	17.0	18.0	1.4~1.8	6.4	0.4

STANDARD RATINGS

D×L(mm) ; R.C.(mA rms) at 125°C 100KHz, IMP(Ω max) at 20°C 100KHz.

Cap (µF)	V	6.3			10			16			25		
		D x L	R.C.	IMP	DxL	R.C.	IMP	D x L	R.C.	IMP	D x L	R.C.	IMP
33											6.3x6.0	70	1.6
47					6.3x6.0	70	1.6	6.3x6	70	1.6	6.3x7.7	110	0.90
100		6.3x6.0	70	1.6	6.3x7.7	110	0.90	8x10	160	0.40	6.3x7.7	110	0.90
220		6.3x7.7	110	0.90	6.3x7.7	110	0.90	8x10	160	0.40	8x10	160	0.40
					8x10	160	0.40				10x10	220	0.30
330		8x10	160	0.40	8x10	160	0.40	10x10	220	0.30	10x10	220	0.30
											12.5x13.5	550	0.12
470		8x10	160	0.40	10x10	220	0.30	12.5x13.5	550	0.12	12.5x13.5	550	0.12
680		10x10	220	0.30	12.5x13.5	550	0.12	12.5x13.5	550	0.12	12.5x13.5	550	0.12
1000		12.5x13.5	550	0.12	12.5x13.5	550	0.12	12.5x13.5	550	0.12	16x16.5	900	0.080
1500		12.5x13.5	550	0.12	12.5x13.5	550	0.12	16x16.5	900	0.080	16x16.5	900	0.080
2200		12.5x13.5	550	0.12	16x16.5	900	0.080	16x16.5	900	0.080			
3300		16x16.5	900	0.08	16x16.5	900	0.080						
4700		16x16.5	900	0.08									

Cap (µF)	V	35			50			63			100		
		D x L	R.C.	IMP	DxL	R.C.	IMP	D x L	R.C.	IMP	D x L	R.C.	IMP
1					6.3x6.0	45	3.5						
2.2					6.3x6.0	45	3.5						
3.3					6.3x6.0	45	3.5						
4.7		6.3x6.0	60	2.0	6.3x6.0	45	3.5						
10		6.3x6.0	70	1.6	6.3x6.0	50	2.8				8x10	70	1.00
22		6.3x6.0	70	1.6	6.3x7.7	80	2.0	8x10	100	1.00	8x10	70	1.00
33		6.3x7.7	110	0.90	6.3x7.7	80	2.0	8x10	100	1.00	10x10	115	0.80
					8x10	140	0.70						
47		6.3x7.7	110	0.90	8x10	140	0.70	8x10	100	1	12.5x13.5	350	0.33
		8x10	160	0.40	10x10	240	0.50	10x10	150	0.5			
100		8x10	160	0.40	10x10	240	0.50	10x10	150	0.5	16x16.5	500	0.240
		10x10	220	0.30	12.5x13.5	490	0.23	12.5x13.5	350	0.250			
220		10x10	220	0.30	12.5x13.5	490	0.23	12.5x13.5	350	0.250			
		12.5x13.5	550	0.12				16x16.5	500	0.18			
330		12.5x13.5	550	0.12	12.5x13.5	490	0.23	16x16.5	500	0.18			
					16x16.5	800	0.15						
470.0		12.5x13.5	550	0.12	16x16.5	800	0.15	16x16.5	500	0.18			
		16x16.5	900	0.080									
680.0		16x16.5	900	0.080	16x16.5	800	0.15						
1000.0		16x16.5	900	0.080									

CGV series

- Chip type with 8Ø~16Ø, 125°C, 2,000 hours, long life product.
- Peak acceleration: 30G
- RoHS Compliance.
- 8Ø~16ØV-Chip型, 125°C, 2,000小時長壽命產品。
- 專為汽車模組和其它高溫應用設計。
- 峰值加速度：30G。



SPECIFICATIONS

Items 項目	Characteristics 特性								
Capacitance Tolerance 靜電容量誤差	± 20%(120Hz,20°C)								
Operating Temperature Range 適用溫度範圍	-55 ~ +125°C								
Rated Voltage Range 額定電壓範圍	6.3 ~ 100VDC								
Capacitance Range 靜電容量範圍	1 ~ 4700µF								
Leakage Current 洩漏電流	I ≤ 0.01CV or 3(µA) , which is greater. (After 3 minutes application of DC rated voltage, at 20°C)								
Dissipation Factor 散逸因素(tan δ)	Measurement Frequency: 120Hz. Temperature: 20°C								
	Rated Voltage(V)	6.3	10	16	25	35	50	63	100
	tan δ(Max)	0.30	0.24	0.20	0.16	0.14	0.14	0.12	0.10
Low Temperature Stability 低溫特性 Impedance Ratio(Max) 阻抗比率(最大值)	Measurement Frequency: 120Hz.								
	Rated Voltage(V)	6.3	10	16	25	35	50	63	100
	Z(-25°C)/Z(20°C)	4	3	2	2	2	2	2	2
	Z(-40°C)/Z(20°C)	8	6	4	3	3	3	3	3
Load Life 負荷壽命	6.3V~50V:2,000hours;63V~100V:1,500 hours with application of rated voltage at 125°C								
	Capacitance Change	within ±30% of Initial Value							
	tan δ	300% or less of Initial Specified Value							
	Leakage Current	Initial Specified Value or less							
Shelf Life 放置壽命	The following specifications shall be satisfied when the capacitors are restored to 20°C after exposing them for 1,000 hours 125°C without voltage applied. Before the measurement, the capacitor shall be preconditioned by applying voltage according to them 4.1 of JIS C5101-4.								
	Capacitance Change	Within ± 30% of Initial Value							
	tan δ	300% or less of Initial Specified Value							
	Leakage Current	Initial Specified Value or less							
Resistance to Soldering Heat 焊錫耐熱性	The capacitors shall be kept on the hot plate maintained at 250°C for 30 seconds.					Capacitance Change		Within ± 10% of Initial Value	
	After removing from the hot plate and restored at room temperature they meet the characteristics requirements listed at right.					tan δ		Initial Specified Value	
						Leakage Current		Initial Specified Value or less	
Standards 參照標準	Black print on the case top								

Frequency Coefficient of Permissible Ripple Current

Frequency (Hz)	100 ≤ F < 1K	1K ≤ F < 10K	10K ≤ F < 100K	100K ≤ F
Capacitance (µF)				
C ≤ 22	0.50	0.80	0.90	1.00
22 < C ≤ 150	0.65	0.85	0.92	1.00
150 < C	0.70	0.85	0.95	1.00

The endurance of capacitors is reduced with internal heating produced by ripple current at the rate of halving the lifetime with every 5°C rise. When long life performance is required in actual use , the rms ripple current has to be reduced.

CGV series

DIMENSIONS(mm)

Chip Type

Fig.1 ØD=8~10mm

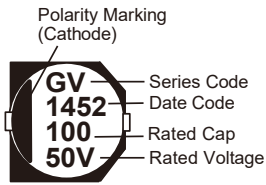
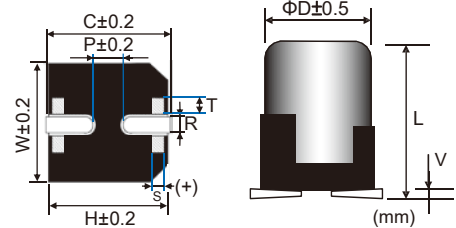
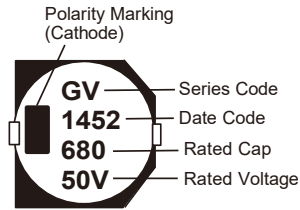

Fig.2 ØD ≥ 12.5mm



(mm)

Size	ØD	L	W	H	C	R	P	S	T	Vmax
8×10.5	8.0	10.5±0.5	8.3	8.3	9.0	0.7~1.1	3.2	0.7	1.3	0.3
10×10.5	10.0	10.5±0.5	10.3	10.3	11.0	1.0~1.4	4.5	0.7	1.3	0.3
12.5×13.5	12.5	13.5±1	13.5	13.5	14.2	1.0~1.4	4.5	2.2	2.4	0.4
16×16.5	16.0	16.5±1	17.0	17.0	18.0	1.4~1.8	6.4	3.0	2.0	0.4

STANDARD RATINGS

D×L(mm) ; R.C.(mA rms) at 125°C 100KHz, IMP(Ω max) at 20°C 100KHz.

Cap (µF)	V	6.3			10			16			25		
		Item	D x L	R.C.	IMP	DxL	R.C.	IMP	D x L	R.C.	IMP	D x L	R.C.
100								8x10.5	160	0.40	8x10.5	160	0.40
220					8x10.5	160	0.40	8x10.5	160	0.40	8x10.5	160	0.40
				10x10.5							220	0.30	
330		8x10.5	160	0.40	8x10.5	160	0.40	10x10.5	220	0.30	10x10.5	220	0.30
				12.5x13.5							550	0.12	
470		8x10.5	160	0.40	10x10.5	220	0.30	12.5x13.5	550	0.12	12.5x13.5	550	0.12
680		10x10.5	220	0.30	12.5x13.5	550	0.12	12.5x13.5	550	0.12	12.5x13.5	550	0.12
1000		12.5x13.5	550	0.12	12.5x13.5	550	0.12	12.5x13.5	550	0.12	16x16.5	900	0.080
1500		12.5x13.5	550	0.12	12.5x13.5	550	0.12	16x16.5	900	0.080	16x16.5	900	0.080
2200		12.5x13.5	550	0.12	16x16.5	900	0.080	16x16.5	900	0.080			
3300		16x16.5	900	0.08	16x16.5	900	0.080						
4700		16x16.5	900	0.08									

Cap (µF)	V	35			50			63			100		
		Item	D x L	R.C.	IMP	DxL	R.C.	IMP	D x L	R.C.	IMP	D x L	R.C.
10											8x10.5	70	1.00
22								8x10.5	100	1.00	8x10.5	70	1.00
33					8x10.5	140	0.70	8x10.5	100	1.00	10x10.5	115	0.80
47					8x10.5	140	0.70	8x10.5	100	1.00	12.5x13.5	350	0.33
		8x10.5	160	0.40									
100		8x10.5	160	0.40	10x10.5	240	0.50	10x10.5	150	0.50	16x16.5	500	0.24
		10x10.5	220	0.30	12.5x13.5	490	0.23	12.5x13.5	350	0.25			
220		10x10.5	220	0.30	12.5x13.5	490	0.23	12.5x13.5	350	0.25			
		12.5x13.5	550	0.12							16x16.5	500	0.18
330		12.5x13.5	550	0.12	12.5x13.5	490	0.23	16x16.5	500	0.18			
				16x16.5	800	0.15							
470.0		12.5x13.5	550	0.12	16x16.5	800	0.15	16x16.5	500	0.18			
		16x16.5	900	0.080									
680.0		16x16.5	900	0.080	16x16.5	800	0.15						
1000.0		16x16.5	900	0.080									

CTS series

- Chip type with 8Ø~16Ø, 125°C, 5,000 hours, long life product.
- Designed For automobile modules and other high temperature applications.
- RoHS Compliance.
- 8Ø~16ØV-Chip型，125°C，5000小時長壽命產品。
- 專為汽車模組和其它高溫應用設計。



SPECIFICATIONS

Items 項目	Characteristics 特性				
Capacitance Tolerance 靜電容量誤差	± 20%(120Hz,20°C)				
Operating Temperature Range 適用溫度範圍	-40 ~ +125°C				
Rated Voltage Range 額定電壓範圍	16~50VDC				
Capacitance Range 靜電容量範圍	33~2200µF				
Leakage Current 洩漏電流	$I \leq 0.01CV$ or $3(\mu A)$, which is greater. (After 2 minutes application of DC rated voltage, at 20°C)				
Dissipation Factor 散逸因素($\tan \delta$)	Measurement Frequency: 120Hz. Temperature: 20°C				
	Rated Voltage(V)	16	25	35	50
	$\tan \delta$ (Max)	0.20	0.20	0.14	0.14
Low Temperature Stability 低溫特性 Impedance Ratio(Max) 阻抗比率(最大值)	Measurement Frequency: 120Hz.				
	Rated Voltage(V)	16	25	35	50
	Z(-25°C)/Z(20°C)	5	2	2	2
	Z(-40°C)/Z(20°C)	8	4	3	3
Load Life 負荷壽命	$\Phi 8 \sim \Phi 10$:2000hours; $\Phi 12.5$:3000hours ; $\Phi 16$: 5000hours with application of rated voltage at 125°C				
	Capacitance Change	Within ±30% of Initial Value			
	$\tan \delta$	300% or less of Initial Specified Value			
	Leakage Current	Initial Specified Value or less			
Shelf Life 放置壽命	The following specifications shall be satisfied when the capacitors are restored to 20°C after exposing them for 1000 hours 125°C without voltage applied. Before the measurement, the capacitor shall be preconditioned by applying voltage according to them 4.1 of JIS C5101-4.				
	Capacitance Change	Within ±30% of Initial Value			
	$\tan \delta$	300% or less of Initial Specified Value			
	Leakage Current	Initial Specified Value or less			
Resistance to Soldering Heat 焊錫耐熱性	The capacitors shall be kept on the hot plate maintained at 250°C for 30 seconds. After removing from the hot plate and restored at room temperature they meet the characteristics requirements listed at right.			Capacitance Change	Within ± 10% of Initial Value
				$\tan \delta$	Initial Specified Value
				Leakage Current	Initial Specified Value or less
Standards 參照標準	Black print on the case top				

Frequency Coefficient of Permissible Ripple Current

Frequency (Hz)	100 ≤ F < 1K	1K ≤ F < 10K	10K ≤ F < 100K	100K ≤ F
Capacitance (µF)				
全系列	0.60	0.85	0.93	1.00

The endurance of capacitors is reduced with internal heating produced by ripple current at the rate of halving the lifetime with every 5°C rise. When long life performance is required in actual use , the rms ripple current has to be reduced.

CTS series

DIMENSIONS(mm)

Chip Type

Fig.1 $\varnothing D=8\sim 10\text{mm}$

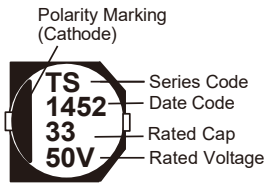
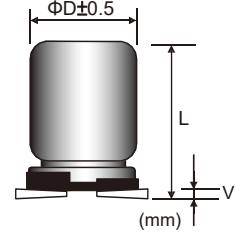
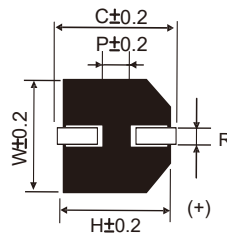
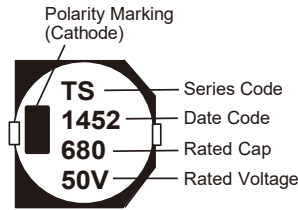

Fig.2 $\varnothing D \geq 12.5\text{mm}$



Size	$\varnothing D$	$L \pm 0.5$	W	H	C	R	P	Vmax
8×10	8.0	10.0	8.3	8.3	9.0	0.7~1.1	3.2	0.3
10×10	10.0	10.0	10.3	10.3	11.0	0.7~1.3	4.5	0.3
12.5×13.5	12.5	13.5	13.0	13.0	13.7	1.1~1.4	4.5	0.4
16×16.5	16.0	16.5	17.0	17.0	18.0	1.4~1.8	6.4	0.4

STANDARD RATINGS

D×L(mm) ; R.C.(mA rms) at 105°C 100KHz, IMP(Ω max) at 20°C 100KHz.

Cap (μF)	V Item	16.0			25			35			50		
		D x L	R.C.	IMP	D x L	R.C.	IMP	D x L	R.C.	IMP	D x L	R.C.	IMP
47											8x10	250	0.5
100								8x10	300	0.18	10x10	350	0.30
160								8x10	300	0.18			
220					8x10	300	0.18	10x10	500	0.11	12.5x13.5	700	0.15
270					8x10	300	0.18						
300								10x10	500	0.11			
330		8x10	300	0.18	10x10	500	0.11	12.5x13.5	1200	0.08			
390		8x10	300	0.18									
470		10x10	500	0.11	10x10	500	0.11	12.5x13.5	1200	0.08	16x16.5	1000	0.09
620								12.5x13.5	1200	0.08			
680		10x10	500	0.11	12.5x13.5	1200	0.08	16x16.5	1800	0.05			
910					12.5x13.5	1200	0.08						
1000		12.5x13.5	1200	0.08	16x16.5	1800	0.05						
1500		12.5x13.5	1200	0.08	16x16.5	1800	0.05						
2200		16x16.5	1800	0.05									

CTV series

- Chip type with 8Ø~16Ø, 125°C, 5,000 hours, long life product.
- Designed For automobile modules and other high temperature applications.
- Peak acceleration: 30G
- RoHS Compliance.
- 8Ø~16ØV-Chip型，125°C，5000小時長壽命產品。
- 專為汽車模組和其它高溫應用設計。
- 峰值加速度：30G。



SPECIFICATIONS

Items 項目	Characteristics 特性				
Capacitance Tolerance 靜電容量誤差	± 20%(120Hz,20°C)				
Operating Temperature Range 適用溫度範圍	-40 ~ +125°C				
Rated Voltage Range 額定電壓範圍	16~50VDC				
Capacitance Range 靜電容量範圍	33~2200µF				
Leakage Current 洩漏電流	$I \leq 0.01CV$ or $3(\mu A)$, which is greater. (After 2 minutes application of DC rated voltage, at 20°C)				
Dissipation Factor 散逸因素($\tan \delta$)	Measurement Frequency: 120Hz. Temperature: 20°C				
	Rated Voltage(V)	16	25	35	50
	$\tan \delta$ (Max)	0.20	0.20	0.14	0.14
Low Temperature Stability 低溫特性 Impedance Ratio(Max) 阻抗比率(最大值)	Measurement Frequency: 120Hz.				
	Rated Voltage(V)	16	25	35	50
	Z(-25°C)/Z(20°C)	5	2	2	2
	Z(-40°C)/Z(20°C)	8	4	3	3
Load Life 負荷壽命	$\Phi 8 \sim \Phi 10$:2000hours; $\Phi 12.5$:3000hours ; $\Phi 16$: 5000hours with application of rated voltage at 125°C				
	Capacitance Change	Within ±30% of Initial Value			
	$\tan \delta$	300% or less of Initial Specified Value			
	Leakage Current	Initial Specified Value or less			
Shelf Life 放置壽命	The following specifications shall be satisfied when the capacitors are restored to 20°C after exposing them for 1000 hours 125°C without voltage applied. Before the measurement, the capacitor shall be preconditioned by applying voltage according to them 4.1 of JIS C5101-4.				
	Capacitance Change	Within ±30% of Initial Value			
	$\tan \delta$	300% or less of Initial Specified Value			
	Leakage Current	Initial Specified Value or less			
Resistance to Soldering Heat 焊錫耐熱性	The capacitors shall be kept on the hot plate maintained at 250°C for 30 seconds. After removing from the hot plate and restored at room temperature they meet the characteristics requirements listed at right.	Capacitance Change	Within ± 10% of Initial Value		
		$\tan \delta$	Initial Specified Value		
		Leakage Current	Initial Specified Value or less		
Standards 參照標準	Black print on the case top				

Frequency Coefficient of Permissible Ripple Current

Frequency (Hz)	100 ≤ F < 1K	1K ≤ F < 10K	10K ≤ F < 100K	100K ≤ F
Capacitance (µF)				
全系列	0.60	0.85	0.93	1.00

The endurance of capacitors is reduced with internal heating produced by ripple current at the rate of halving the lifetime with every 5°C rise. When long life performance is required in actual use , the rms ripple current has to be reduced.

CTV series

DIMENSIONS(mm)

Chip Type

Fig.1 $\varnothing D=8\sim 10\text{mm}$

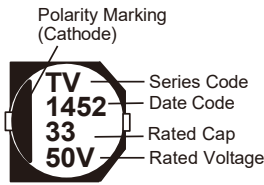
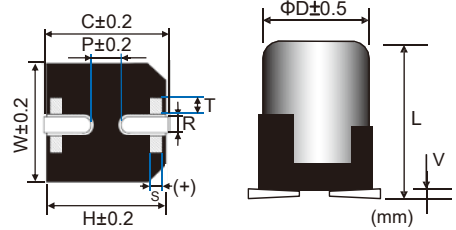
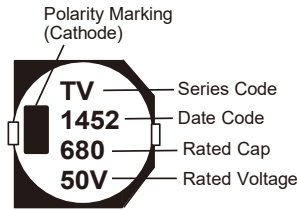

Fig.2 $\varnothing D \geq 12.5\text{mm}$



(mm)

Size	$\varnothing D$	L	W	H	C	R	P	S	T	Vmax
8×10.5	8.0	10.5±0.5	8.3	8.3	9.0	0.7~1.1	3.2	0.7	1.3	0.3
10×10.5	10.0	10.5±0.5	10.3	10.3	11.0	1.0~1.4	4.5	0.7	1.3	0.3
12.5×13.5	12.5	13.5±1	13.5	13.5	14.2	1.0~1.4	4.5	2.2	2.4	0.4
16×16.5	16.0	16.5±1	17.0	17.0	18.0	1.4~1.8	6.4	3.0	2.0	0.4

STANDARD RATINGS

D×L(mm) ; R.C.(mA rms) at 125°C 100KHz, IMP(Ω max) at 20°C 100KHz.

Cap (μF)	V	16.0			25			35			50		
		Item	D x L	R.C.	IMP	D x L	R.C.	IMP	D x L	R.C.	IMP	D x L	R.C.
47											8x10.5	250	0.5
100								8x10.5	300	0.18	10x10.5	350	0.30
160								8x10.5	300	0.18			
220					8x10.5	300	0.18	10x10.5	500	0.11	12.5x13.5	700	0.15
270					8x10.5	300	0.18						
300								10x10.5	500	0.11			
330		8x10.5	300	0.18	10x10.5	500	0.11	12.5x13.5	1200	0.08			
390		8x10.5	300	0.18									
470		10x10.5	500	0.11	10x10.5	500	0.11	12.5x13.5	1200	0.08	16x16.5	1000	0.09
620								12.5x13.5	1200	0.08			
680		10x10.5	500	0.11	12.5x13.5	1200	0.08	16x16.5	1800	0.05			
910					12.5x13.5	1200	0.08						
1000		12.5x13.5	1200	0.08	16x16.5	1800	0.05						
1500		12.5x13.5	1200	0.08	16x16.5	1800	0.05						
2200		16x16.5	1800	0.05									

CTV

CDS series

- Low impedance, 105°C 2000 hours High CV.
- Applicable to SMT process.
- RoHS Compliance.
- 105°C 低阻抗、2000hours 高比容產品。
- 適用於SMT制程。



SPECIFICATIONS

Items 項目	Characteristics 特性						
Capacitance Tolerance 靜電容量誤差	± 20%(120Hz,20°C)						
Operating Temperature Range 適用溫度範圍	-55°C ~ + 105°C						
Rated Voltage Range 額定電壓範圍	6.3~50VDC						
Capacitance Range 靜電容量範圍	10~2200μF						
Leakage Current 洩漏電流	I _{leak} ≤ 0.01CV or 3 (μA) , which is greater. (After 2 minutes application of DC rated voltage, at 20°C)						
Dissipation Factor 散逸因素(tan δ)	Measurement Frequency:120Hz. Temperature: 20°C						
	Rated Voltage(V)	6.3	10	16	25	35	50
	tan δ(Max)	0.26	0.19	0.16	0.14	0.12	0.10
Low Temperature Stability 低溫特性 Impedance Ratio(Max) 阻抗比率(最大值)	Measurement Frequency: 120Hz.						
	Rated Voltage(V)	6.3	10	16	25	35	50
	Z(-25°C)/Z(20°C)	4	3	2	2	2	2
	Z(-40°C)/Z(20°C)	8	5	4	3	3	3
Load Life 負荷壽命	2000hours,with application of rated voltage at 105°C						
	Capacitance Change	within ±30% of Initial Value					
	tan δ	200% or less of Initial Specified Value					
	Leakage Current	Initial Specified Value or less					
Shelf Life 放置壽命	The following specifications shall be satisfied when the capacitors are restored to 20°C after exposing them for 1000hours 105°C without voltage applied. Before the measurement. The Capacitance shall be preconditioned by applying voltage according to them 4.1 of JIS C5101-4.						
	Capacitance Change	within ±30% of Initial Value					
	tan δ	200% or less of Initial Specified Value					
	Leakage Current	Initial Specified Value or less					
Resistance to Soldering Heat 焊錫耐熱性	The capacitors shall be kept on the hot plate maintained at 250°C for 30 seconds. After removing from the hot plate and restored at room temperature they meet the characteristics requirements listed at right.					Capacitance Change	Within ± 10% of Initial Value
						tan δ	Initial Specified Value
						Leakage Current	Initial Specified Value or less
Standards 參照標準	JIS C 5101-4-1 (IEC 60384)						

Frequency Coefficient of Permissible Ripple Current

Frequency (Hz)	120 ≤ F < 1K	1K ≤ F < 10K	10K ≤ F < 100K	100K ≤ F
Capacitance (μF)				
≤ 470	0.65	0.85	0.95	1.00
>470	0.70	0.90	0.95	1.00

The endurance of capacitors is reduced with internal heating produced by ripple current at the rate of halving the lifetime with every 5°C rise. when long life performance is required in actual use. The rms ripple current has to be reduced.

CDS series

DIMENSIONS(mm)

Chip Type

Fig.1 $\Phi D=6.3\sim 10\text{mm}$

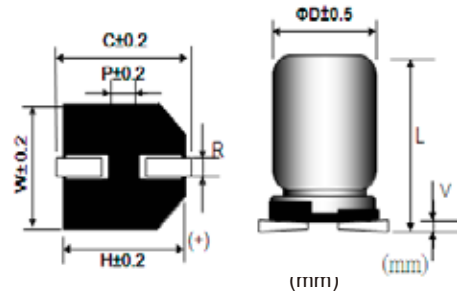
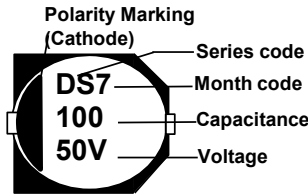

Size	∅D	L	W	H	C	R	P	Vmax
4×6.0	4.0	6.0±0.3	4.3	4.3	5.1	0.5~0.8	1.0	0.3
5×6.0	5.0	6.0±0.3	5.3	5.3	5.9	0.5~0.8	1.5	0.3
6.3×6.0	6.3	6.0±0.3	6.6	6.6	7.2	0.5~0.8	2.1	0.3
6.3×7.7	6.3	7.7±0.3	6.6	6.6	7.2	0.5~0.8	2.1	0.3
8×10	8.0	10±0.5	8.4	8.4	9.0	0.7~1.1	3.2	0.3
10×10	10.0	10±0.5	10.4	10.4	11.0	0.7~1.3	4.5	0.3

STANDARD RATINGS

D×L(mm) ; R.C.(mA rms) at 105°C 100KHz, IMP(Ω max) at 20°C 100KHz.

Cap (μF)	V	6.3			10			16			25			35			50			
		Item	D x L	R.C.	IMP	D x L	R.C.	IMP	D x L	R.C.	IMP	D x L	R.C.	IMP	D x L	R.C.	IMP	D x L	R.C.	IMP
10																		4x6.0	85	2.30
																		5x6.0	165	0.88
22											4x6.0	160	0.85	4x6.0	160	0.85	5x6.0	165	0.88	
33											4x6.0	160	0.85	5x6.0	240	0.40				
47								4x6.0	160	0.85	5x6.0	240	0.36	5x6.0	240	0.36	6.3x6.0	195	0.68	
68					4x6.0	160	0.85	5x6.0	240	0.36	5x6.0	240	0.36	6.3x6.0	300	0.26				
100	4x6.0	160	0.85					5x6.0	240	0.36	6.3x6.0	300	0.26	6.3x6.0	300	0.26	6.3x7.7	350	0.34	
150					5x6.0	240	0.36	6.3x6.0	300	0.26	6.3x7.7	600	0.16	6.3x7.7	600	0.16				
220	5x6.0	240	0.36	6.3x6.0	300	0.26	6.3x6.0	300	0.26	6.3x7.7	600	0.16					8x10	670	0.18	
330	6.3x6.0	300	0.26	6.3x7.7	600	0.16	6.3x7.7	600	0.160					8x10			10x10	900	0.12	
470	6.3x7.7	600	0.16	6.3x7.7	600	0.16					8x10	850	0.08							
560														10x10						
680	6.3x7.7	600	0.16					8x10	850	0.08										
820											10x10	1190	0.06							
1000					8x10	850	0.08	10x10	1190	0.06										
1500	8x10	850	0.08	10x10	1190	0.060														
2200	10x10	1190	0.06																	

CLL series

- Low impedance, 105°C 7000~10000 hours Long Life.
- Applicable to SMT process.
- RoHS Compliance.
- 105°C 低阻抗、7000~10000hours 長壽命產品。
- 適用於SMT制程。



SPECIFICATIONS

Items 項目	Characteristics 特性						
Capacitance Tolerance 靜電容量誤差	± 20%(120Hz,20°C)						
Operating Temperature Range 適用溫度範圍	-25°C ~ + 105°C						
Rated Voltage Range 額定電壓範圍	6.3~50VDC						
Capacitance Range 靜電容量範圍	10~1000μF						
Leakage Current 洩漏電流	I ≤ 0.01CV or 3 (μA) , which is greater. (After 2 minutes application of DC rated voltage, at 20°C)						
Dissipation Factor 散逸因素(tan δ)	Measurement Frequency:120Hz. Temperature: 20°C						
	Rated Voltage(V)	6.3	10	16	25	35	50
	tan δ(Max)	0.32	0.28	0.26	0.16	0.14	0.14
Low Temperature Stability 低溫特性 Impedance Ratio(Max) 阻抗比率(最大值)	Measurement Frequency:120Hz						
	Rated Voltage(V)	6.3	10	16	25	35	50
	Z(-25°C)/Z(20°C)	4	3	2	2	2	2
Load Life 負荷壽命	Φ ≤ 6.3 : 7000hours, Φ ≥ 8 : 10000 with application of rated voltage at 105°C						
	Capacitance Change	within ±30% of Initial Value					
	tan δ	300% or less of Initial Specified Value					
	Leakage Current	Initial Specified Value or less					
Shelf Life 放置壽命	The following specifications shall be satisfied when the capacitors are restored to 20°C after exposing them for 1000hours 105°C without voltage applied. Before the measurement. The Capacitance shall be preconditioned by applying voltage according to them 4.1 of JIS C5101-4.						
	Capacitance Change	within ±30% of Initial Value					
	tan δ	300% or less of Initial Specified Value					
	Leakage Current	Initial Specified Value or less					
Resistance to Soldering Heat 焊錫耐熱性	The capacitors shall be kept on the hott plate maintained at 250°C for 30seconds. After removing from the hot plate and restored at room temperature they meet the characteristics requirements listed at right.					Capacitance Change	Within ± 10% of Initial Value
						tan δ	Initial Specified Value
						Leakage Current	Initial Specified Value or less
Standards 參照標準	JIS C 5101-4-1 (IEC 60384)						

Frequency Coefficient of Permissible Ripple Current

Frequency (Hz) Capacitance (μF)	120 ≤ F < 1K	1K ≤ F < 10K	10K ≤ F < 100K	100K ≤ F
C ≤ 22	0.50	0.80	0.90	1.00
22 < C ≤ 150	0.65	0.85	0.92	1.00
C > 150	0.70	0.85	0.95	1.00

The endurance of capacitors is reduced with internal heating produced by ripple current at the rate of halving the lifetime with every 5°C rise. when long life performance is required in actual use. The rms ripple current has to be reduced.

CLL

CLL series

DIMENSIONS(mm)

Chip Type

Fig.1 $\Phi D=6.3\sim 10\text{mm}$

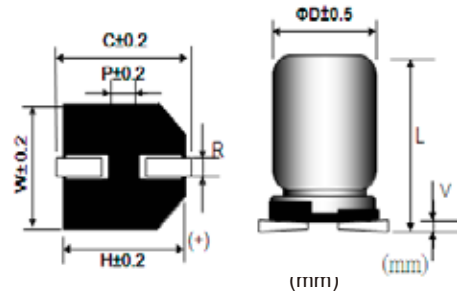
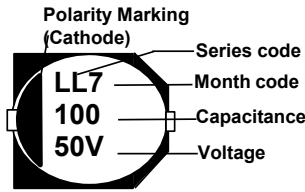

Size	ØD	L	W	H	C	R	P	Vmax
4×7	4.0	7.0±0.3	4.3	4.3	5.1	0.5~0.8	1.0	0.3
5×7	5.0	7.0±0.3	5.3	5.3	5.9	0.5~0.8	1.4	0.3
6.3×7	6.3	7.0±0.3	6.6	6.6	7.2	0.5~0.8	2.1	0.3
6.3×8.4	6.3	8.4±0.3	6.6	6.6	7.2	0.5~0.8	2.1	0.3
8×10	8.0	10±0.5	8.4	8.4	9.0	0.7~1.1	3.2	0.3
10×10	10.0	10±0.5	10.4	10.4	11.0	0.7~1.3	4.5	0.3

STANDARD RATINGS

D×L(mm) ; R.C.(mA rms) at 105°C 100KHz, IMP(Ω max) at 20°C 100KHz.

Cap (µF)	V	6.3			10			16			25			35			50			
		Item	D x L	R.C.	IMP	D x L	R.C.	IMP	D x L	R.C.	IMP	D x L	R.C.	IMP	D x L	R.C.	IMP	D x L	R.C.	IMP
10								4x7.0	27	4.00				5x7.0	95	2.20				
								5x7.0	95	2.20	5x7.0	95	2.20	5x7.0	95	2.20	6.3x8.4	100	1.80	
22											6.3x7.0	140	1.10	6.3x8.4	230	1.00	8x10	350	0.53	
33					5x7.0	95	2.20	6.3x7.0	140	1.10	6.3x7.0	140	1.10	6.3x8.4	230	1.00	8x10	350	0.53	
47	5x7.0	95	2.20					6.3x7.0	140	1.10	6.3x8.4	230	1.00	8x10	600	0.22	10x10	670	0.35	
100	6.3x7.0	140	1.10					6.3x8.4	230	1.00	8x10	600	0.22							
150					6.3x7.0	140	1.10	6.3x8.4	230	1.00	8x10	600	0.22	10x10	850	0.16				
220	6.3x8.4	230	1.00					8x10	600	0.220	10x10	850	0.16	10x10	850	0.16				
330	6.3x8.4	230	1.00					10x10	850	0.160										
470	8x10	600	0.22																	
1000	10x10	850	0.16																	

CLL

H5 series

- Subminiature product, 105°C.
- Applicable to small electronic devices.
- Height : 5mm.
- RoHS Compliance
- 105°C超小型產品。
- 適用於小型電子設備。
- 高度：5mm系列。



SPECIFICATIONS

Items 項目	Characteristics 特性							
Capacitance Tolerance 靜電容量誤差	± 20%(120Hz,20°C)							
Operating Temperature Range 適用溫度範圍	-40 ~ +105°C							
Rated Voltage Range 額定電壓範圍	4 ~ 50VDC							
Leakage Current 洩漏電流	I ≤ 0.01CV or 3 (μA) which is greater.(After 2 minutes application of DC rated voltage, at 20 °C)							
Dissipation Factor 散逸因素(tan δ)	Measurement Frequency: 120Hz. Temperature: 20°C							
	Rated Voltage(V)	4	6.3	10	16	25	35	50
	tan δ(Max)	0.35	0.24	0.20	0.16	0.15	0.14	0.13
Low Temperature Stability 低溫特性 Impedance Ratio(Max) 阻抗比率(最大值)	Measurement Frequency: 120Hz.							
	Rated Voltage(V)	4	6.3	10	16	25	35	50
	Z(-25°C)/Z(20°C)	6	3	3	2	2	2	2
	Z(-40°C)/Z(20°C)	12	8	5	4	3	3	3
Load Life 負荷壽命	1000hours,with application of rated voltage at 105°C							
	Capacitance Change	Within ± 20% of Initial Value						
	tan δ	200% or less of Initial Specified Value						
	Leakage Current	Initial Specified Value or less						
Shelf Life 放置壽命	The following specifications shall be satisfied when the capacitors are restored to 20°C after exposing them for 1,000 hours 105°C without voltage applied. Before the measurement, the capacitor shall be preconditioned by applying voltage according to them 4.1 of JIS C5101-4.							
	Capacitance Change	Within ± 20% of Initial Value						
	tan δ	200% or less of Initial Specified Value						
	Leakage Current	Initial Specified Value or less						
Standards 參照標準	JIS C 5101-4 (IEC 60384)							

Frequency Coefficient of Permissible Ripple Current

Capacitance (μF)	Frequency (Hz)			
	50	120	1K	≥ 10K
< 100	0.80	1.00	1.30	1.50
≥ 100	0.80	1.00	1.15	1.20

The endurance of capacitors is reduced with internal heating produced by ripple current at the rate of halving the lifetime with every 5°C rise. When long life performance is required in actual use , the rms ripple current has to be reduced.

H5 series

DIMENSIONS(mm)

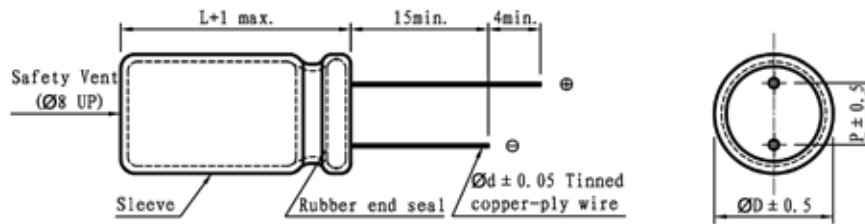

ϕ D	4	5	6.3	8
P	1.5	2.0	2.5	2.5
ϕ d	0.45	0.45	0.45	0.45

STANDARD RATINGS

D×L(mm) ; R.C.(mA rms) at 105°C 120Hz.

Cap (µF)	V	4		6.3		10		16	
		Item	D x L	R.C.	D x L	R.C.	D x L	R.C.	D x L
10						4x5	16	4x5	18
22		4x5	20	4x5	21	4x5	25	4x5	33
33		5x5	28	5x5	29	5x5	34	5x5	44
47		5x5	33	5x5	34	6.3x5	46	6.3x5	52
100		6.3x5	60	6.3x5	66	6.3x5	77	8x5	93
150		6.3x5	67	6.3x5	75	8x5	100	8x5	115
220		8x5	95	8x5	115	8x5	125		

Cap (µF)	V	25		35		50		
		Item	D x L	R.C.	D x L	R.C.	D x L	R.C.
0.1						4x5	1.0	
0.22						4x5	2.0	
0.33						4x5	3.0	
0.47						4x5	3.7	
1						4x5	6.2	
2.2						4x5	10	
3.3					4x5	11	4x5	14
4.7		4x5	13	4x5	16	5x5	18	
10		4x5	22	5x5	25	6.3x5	28	
22		6.3x5	38	6.3x5	46	6.3x5	59	
33		6.3x5	48	6.3x5	50	8x5	65	
47		6.3x5	58	8x5	69	8x5	78	

H5

M5 series

- Subminiature product, Low impedance, 105°C.
- Applicable to small electronic devices.
- Height : 5mm.
- RoHS Compliance
- 105°C低阻抗、超小型產品。
- 適用於小型電子設備。
- 高度：5mm系列。



SPECIFICATIONS

Items 項目	Characteristics 特性						
Capacitance Tolerance 靜電容量誤差	± 20%(120Hz,20°C)						
Operating Temperature Range 適用溫度範圍	-40 ~ +105°C						
Rated Voltage Range 額定電壓範圍	6.3 ~ 35VDC						
Leakage Current 洩漏電流	$I \leq 0.01CV$ or 3 (μA) which is greater. (After 2 minutes application of DC rated voltage, at 20 °C)						
Dissipation Factor 散逸因素(tan δ)	Measurement Frequency: 120Hz. Temperature: 20°C						
	Rated Voltage(V)	6.3	10	16	25	35	50
	tan δ(Max)	0.22	0.20	0.18	0.14	0.12	0.10
Low Temperature Stability 低溫特性 Impedance Ratio(Max) 阻抗比率(最大值)	Measurement Frequency: 120Hz.						
	Rated Voltage(V)	6.3	10	16	25	35~50	
	Z(-25°C)/Z(20°C)	2	2	2	2	2	
	Z(-40°C)/Z(20°C)	4	4	3	3	3	
Load Life 負荷壽命	1000hours,with application of rated voltage at 105°C						
	Capacitance Change	Within ± 20% of Initial Value					
	tan δ	200% or less of Initial Specified Value					
	Leakage Current	Initial Specified Value or less					
Shelf Life 放置壽命	The following specifications shall be satisfied when the capacitors are restored to 20°C after exposing them for 1,000 hours 105°C without voltage applied. Before the measurement, the capacitor shall be preconditioned by applying voltage according to them 4.1 of JIS C5101-4.						
	Capacitance Change	Within ± 20% of Initial Value					
	tan δ	200% or less of Initial Specified Value					
	Leakage Current	Initial Specified Value or less					
Standards 參照標準	JIS C 5101-4 (IEC 60384)						

M5

Frequency Coefficient of Permissible Ripple Current

Frequency (Hz)	50	120	300	1K	10K ~ 100K
Coefficient	0.50	0.65	0.70	0.90	1.00

The endurance of capacitors is reduced with internal heating produced by ripple current at the rate of halving the lifetime with every 5°C rise. When long life performance is required in actual use , the rms ripple current has to be reduced.

M5 series

DIMENSIONS(mm)

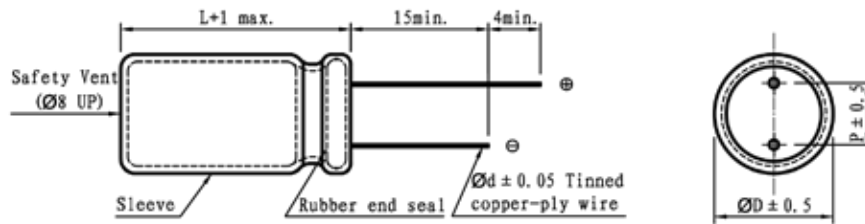

ϕD	4	5	6.3
P	1.5	2.0	2.5
ϕd	0.45	0.45	0.45

STANDARD RATINGS

D×L(mm) ; R.C.(mA rms) at 105°C 100KHz, IMP (Ω max) at 20°C 100KHz.

Cap (μF)	V	6.3			10			16		
		Item	D x L	R.C.	IMP	D x L	R.C.	IMP	D x L	R.C.
10								4x5	55	5.0
15								5x5	80	2.6
22		4x5	52	5.0	5x5	80	2.6	5x5	82	2.5
33		5x5	82	2.5	5x5	82	2.5	6.3x5	113	1.3
47		5x5	85	2.5	6.3x5	115	1.2	6.3x5	115	1.2
68		6.3x5	118	1.3						
100		6.3x5	120	1.2						

Cap (μF)	V	25			35		
		Item	D x L	R.C.	IMP	D x L	R.C.
1					4x5	48	5.0
1.5					4x5	49	4.9
2.2					4x5	50	4.9
3.3					4x5	52	4.8
4.7		4x5	49	5.0	4x5	55	4.8
6.8		4x5	52	4.8	5x5	80	2.6
10		5x5	82	2.5	5x5	85	2.5
15		6.3x5	116	1.3	6.3x5	116	1.3
22		6.3x5	118	1.2	6.3x5	118	1.2
33		6.3x5	120	1.1			

M5

SM series

- Miniature product, 105°C.
- Applicable to small electronic devices.
- Height : 7 mm.
- RoHS Compliance
- 105°C小型化產品。
- 適用於小型電子設備。
- 高度：7mm系列。

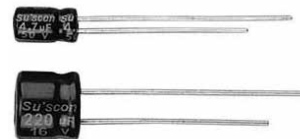

SPECIFICATIONS

Items 項目	Characteristics 特性							
Capacitance Tolerance 靜電容量誤差	± 20%(120Hz,20°C)							
Operating Temperature Range 適用溫度範圍	-40 ~ +105°C							
Rated Voltage Range 額定電壓範圍	6.3 ~ 50VDC							
Leakage Current 洩漏電流	$I \leq 0.01CV$ or 3 (μA) which is greater. (After 2 minutes application of DC rated voltage, at 20 °C)							
Dissipation Factor 散逸因素(tan δ)	Measurement Frequency: 120Hz. Temperature: 20°C							
	Rated Voltage(V)	6.3	10	16	25	35	50	
	tan δ(Max)	0.24	0.20	0.16	0.15	0.12	0.10	
Low Temperature Stability 低溫特性	Measurement Frequency: 120Hz.							
	Rated Voltage(V)	6.3	10	16	25	35	50	
	Impedance Ratio(Max) 阻抗比率(最大值)	Z(-25°C)/Z(20°C)	3	2	2	2	2	2
	Z(-40°C)/Z(20°C)	6	5	4	3	3	3	
Load Life 負荷壽命	1000hours,with application of rated voltage at 105°C							
	Capacitance Change	Within ± 20% of Initial Value						
	tan δ	200% or less of Initial Specified Value						
	Leakage Current	Initial Specified Value or less						
Shelf Life 放置壽命	The following specifications shall be satisfied when the capacitors are restored to 20°C after exposing them for 1,000 hours 105°C without voltage applied. Before the measurement, the capacitor shall be preconditioned by applying voltage according to them 4.1 of JIS C5101-4.							
	Capacitance Change	Within ± 20% of Initial Value						
	tan δ	200% or less of Initial Specified Value						
	Leakage Current	Initial Specified Value or less						
Standards 參照標準	JIS C 5101-4 (IEC 60384)							

Frequency Coefficient of Permissible Ripple Current

Capacitance (μF)	Frequency (Hz)			
	50	120	1K	≥10K
< 100	0.80	1.00	1.30	1.50
≥ 100	0.80	1.00	1.15	1.20

The endurance of capacitors is reduced with internal heating produced by ripple current at the rate of halving the lifetime with every 5°C rise. When long life performance is required in actual use , the rms ripple current has to be reduced.

SM series

DIMENSIONS(mm)

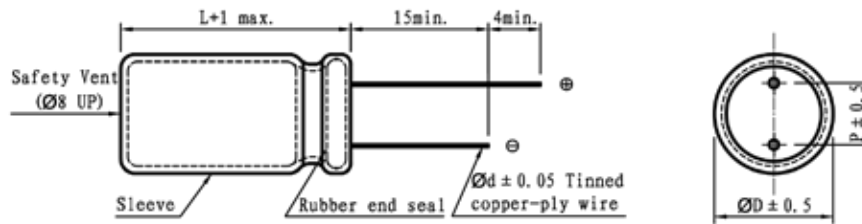

ϕD	4	5	6.3	8
P	1.5	2.0	2.5	3.5
ϕd	0.45	0.5	0.5	0.5

STANDARD RATINGS

D×L(mm) ; R.C.(mA rms) at 105°C 120Hz.

Cap (µF)	V	6.3		10		16	
		D x L	R.C.	D x L	R.C.	D x L	R.C.
10						4x7	28
22		4x7	34	4x7	37	4x7	44
33		4x7	42	4x7	45	5x7	52
47		4x7	50	5x7	60	5x7	69
100		5x7	75	6.3x7	86	6.3x7	95
220		6.3x7	95	8x7	145	8x7	150
330		8x7	160				

Cap (µF)	V	25		35		50	
		D x L	R.C.	D x L	R.C.	D x L	R.C.
0.1						4x7	1.0
0.22						4x7	2.3
0.33						4x7	3.5
0.47						4x7	5.0
1						4x7	10
2.2						4x7	18
3.3				4x7	18	4x7	24
4.7		4x7	22	4x7	22	4x7	28
10		4x7	29	5x7	33	5x7	42
22		5x7	35	6.3x7	55	6.3x7	60
33		6.3x7	62	6.3x7	65	8x7	68
47		8x7	75	8x7	80	8x7	95
100		8x7	95				
150		8x7	105				
180		8x7	120				

SM

MD series

- Miniature, Low impedance, 105°C product.
- Applicable to small electronic devices.
- Height : 7 mm.
- RoHS Compliance
- 105°C 低阻抗、小型化產品。
- 適用於小型電子設備。
- 高度：7mm系列。



SPECIFICATIONS

Items 項目	Characteristics 特性					
Capacitance Tolerance 靜電容量誤差	± 20%(120Hz,20°C)					
Operating Temperature Range 適用溫度範圍	-40 ~ +105°C					
Rated Voltage Range 額定電壓範圍	6.3 ~ 35VDC					
Leakage Current 洩漏電流	$I \leq 0.01CV$ or 3 (μA) which is greater.(After 2 minutes application of DC rated voltage, at 20 °C)					
Dissipation Factor 散逸因素(tan δ)	Measurement Frequency: 120Hz. Temperature: 20°C					
	Rated Voltage(V)	6.3	10	16	25	35
	tan δ(Max)	0.18	0.16	0.14	0.12	0.12
Low Temperature Stability 低溫特性 Impedance Ratio(Max) 阻抗比率(最大值)	Measurement Frequency: 120Hz.					
	Rated Voltage(V)	6.3	10	16	25	35
	Z(-25°C)/Z(20°C)	2	2	2	2	2
	Z(-40°C)/Z(20°C)	3	3	3	3	3
Load Life 負荷壽命	1000hours,with application of rated voltage at 105°C					
	Capacitance Change	Within ± 20% of Initial Value				
	tan δ	200% or less of Initial Specified Value				
	Leakage Current	Initial Specified Value or less				
Shelf Life 放置壽命	The following specifications shall be satisfied when the capacitors are restored to 20°C after exposing them for 1,000 hours 105°C without voltage applied. Before the measurement, the capacitor shall be preconditioned by applying voltage according to them 4.1 of JIS C5101-4.					
	Capacitance Change	Within ± 20% of Initial Value				
	tan δ	200% or less of Initial Specified Value				
	Leakage Current	Initial Specified Value or less				
Standards 參照標準	JIS C 5101-4 (IEC 60384)					

Frequency Coefficient of Permissible Ripple Current

Frequency (Hz)	50	120	300	1K	10K ~ 100K
Coefficient	0.35	0.50	0.64	0.83	1.00

The endurance of capacitors is reduced with internal heating produced by ripple current at the rate of halving the lifetime with every 5°C rise. When long life performance is required in actual use , the rms ripple current has to be reduced.

MD series

DIMENSIONS(mm)

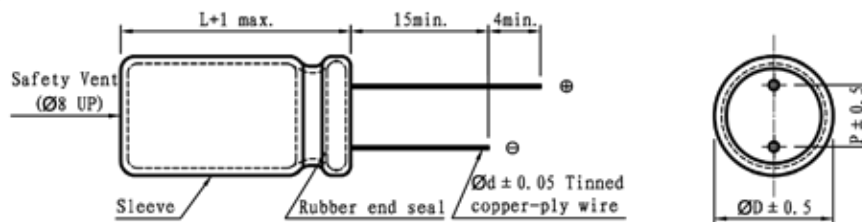

ϕD	4	5	6.3	8
P	1.5	2.0	2.5	3.5
ϕd	0.45	0.5	0.5	0.5

STANDARD RATINGS

D×L(mm) ; R.C.(mA rms) at 105°C 100KHz, IMP (Ω max) at 20°C 100KHz.

Cap (μF)	V Item	6.3			10			16		
		D x L	R.C.	IMP	D x L	R.C.	IMP	D x L	R.C.	IMP
15								4x7	70	3.3
22					4x7	70	3.3	5x7	110	1.7
33	5x7	110	1.7	5x7	115	1.7	6.3x7	160	0.8	
47	5x7	110	1.7	5x7	143	1.3	6.3x7	165	0.8	
68	6.3x7	160	0.8	6.3x7	165	0.8	8x7	200	0.5	
100	6.3x7	160	0.8	8x7	200	0.5	8x7	210	0.5	
150	8x7	200	0.5	8x7	205	0.5				
220	8x7	200	0.5							

Cap (μF)	V Item	25			35		
		D x L	R.C.	IMP	D x L	R.C.	IMP
6.8					4x7	70	3.3
10	4x7	70	3.3	5x7	110	1.7	
15	5x7	110	1.7	6.3x7	132	1.7	
22	5x7	110	1.7	6.3x7	160	0.8	
33	6.3x7	160	0.8	8x7	200	0.5	
47	8x7	200	0.5	8x7	230	0.5	
68	8x7	200	0.5				
100	8x7	300	0.4				

MD

ST series

- Miniature, long life 5000 hours, 105°C product.
- Applicable to small electronic devices.
- Height : 7 mm.
- RoHS Compliance
- 105°C 5000小時、小型化長壽命產品。
- 適用於小型電子設備。
- 高度：7mm系列。

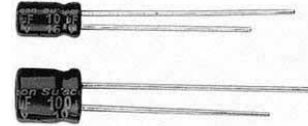

SPECIFICATIONS

Items 項目	Characteristics 特性							
Capacitance Tolerance 靜電容量誤差	± 20%(120Hz,20°C)							
Operating Temperature Range 適用溫度範圍	-40 ~ +105°C							
Rated Voltage Range 額定電壓範圍	6.3 ~ 50VDC							
Leakage Current 洩漏電流	$I \leq 0.01CV$ or 3 (μA) which is greater. (After 2 minutes application of DC rated voltage, at 20 °C)							
Dissipation Factor 散逸因素(tan δ)	Measurement Frequency: 120Hz. Temperature: 20°C							
	Rated Voltage(V)	6.3	10	16	25	35	50	
	tan δ(Max)	0.24	0.20	0.17	0.15	0.13	0.12	
Low Temperature Stability 低溫特性	Measurement Frequency: 120Hz.							
	Rated Voltage(V)	6.3	10	16	25	35	50	
	Impedance Ratio(Max) 阻抗比率(最大值)	Z(-25°C)/Z(20°C)	4	3	2	2	2	2
	Z(-40°C)/Z(20°C)	8	6	4	3	3	3	
Load Life 負荷壽命	5000hours,with application of rated voltage at 105°C							
	Capacitance Change	Within ± 30% of Initial Value						
	tan δ	300% or less of Initial Specified Value						
	Leakage Current	Initial Specified Value or less						
Shelf Life 放置壽命	The following specifications shall be satisfied when the capacitors are restored to 20°C after exposing them for 1,000 hours 105°C without voltage applied. Before the measurement, the capacitor shall be preconditioned by applying voltage according to them 4.1 of JIS C5101-4.							
	Capacitance Change	Within ± 30% of Initial Value						
	tan δ	300% or less of Initial Specified Value						
	Leakage Current	Initial Specified Value or less						
Standards 參照標準	JIS C 5101-4 (IEC 60384)							

Frequency Coefficient of Permissible Ripple Current

Frequency (Hz)	50	120	1K	≥ 10K
Coefficient	0.65	1.00	1.37	1.50

The endurance of capacitors is reduced with internal heating produced by ripple current at the rate of halving the lifetime with every 5°C rise. When long life performance is required in actual use, the rms ripple current has to be reduced.

ST series

DIMENSIONS(mm)

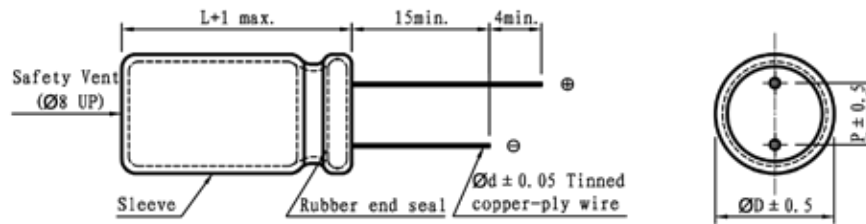

φ D	4	5	6.3	8
P	1.5	2.0	2.5	3.5
φ d	0.45	0.5	0.5	0.5

STANDARD RATINGS

D×L(mm) ; R.C.(mA rms) at 105°C 120Hz.

Cap (μF)	V Item	6.3		10		16	
		D x L	R.C.	D x L	R.C.	D x L	R.C.
10						4x7	29
22		4x7	35	5x7	42	5x7	46
33		5x7	43	5x7	50	6.3x7	58
47		5x7	50	6.3x7	60	6.3x7	70
100		6.3x7	76	8x7	96	8x7	110
220		8x7	131				

Cap (μF)	V Item	25		35		50	
		D x L	R.C.	D x L	R.C.	D x L	R.C.
0.1						4x7	1.5
0.22						4x7	2.5
0.33						4x7	3.5
0.47						4x7	5
1						4x7	12
2.2						4x7	21
3.3						4x7	26
4.7				4x7	26	5x7	31
10		5x7	36	5x7	36	6.3x7	46
22		6.3x7	52	6.3x7	60	8x7	67
33		6.3x7	65	8x7	75		
47		8x7	80				

ST

SL series

- 85°C 2000 hours, standard product.
- RoHS Compliance
- 85°C 2000小時標準品



SPECIFICATIONS

Items 項目	Characteristics 特性										
Capacitance Tolerance 靜電容量誤差	± 20%(120Hz,20°C)										
Operating Temperature Range 適用溫度範圍	-40 ~ +85°C					-40 ~ +85°C			-25 ~ +85°C		
Rated Voltage Range 額定電壓範圍	6.3 ~ 100VDC					160 ~ 250VDC			350 ~ 500VDC		
Leakage Current 洩漏電流	I ≤ 0.01CV or 3 (µA) which is greater.(After 2 minutes application of DC rated voltage, at 20 °C)						I ≤ 0.03CV +20 (µA) (After 3 minutes application of DC rated voltage, at 20 °C)				
Dissipation Factor 散逸因素(tan δ)	Measurement Frequency: 120Hz. Temperature: 20°C										
	Rated Voltage(V)	6.3	10	16	25	35	50	63	100	160~250	350~500
	tan δ(Max)	0.24	0.20	0.16	0.15	0.12	0.10	0.09	0.08	0.20	0.25
	When nominal capacitance over 1000µF, tanδ shall be added 0.02 to the listed value with increase of every 1000µF.										
Low Temperature Stability 低溫特性 Impedance Ratio(Max) 阻抗比率(最大值)	Measurement Frequency: 120Hz.										
	Rated Voltage(V)	6.3	10	16	25	35	50~100	160~250	350~400	450~500	
	Z(-25°C)/Z(20°C)	5	4	3	2	2	2	3	6	8	
	Z(-40°C)/Z(20°C)	12	10	8	6	4	3	4	-	-	
Load Life 負荷壽命	The following specifications shall be satisfied when the capacitors are restored to 20°C after subjected to DC voltage with the rated ripple current is applied for 2,000 hours at 85°C.										
	Capacitance Change	Within ± 20% of Initial Value									
	tan δ	200% or less of Initial Specified Value									
	Leakage Current	Initial Specified Value or less									
Shelf Life 放置壽命	The following specifications shall be satisfied when the capacitors are restored to 20°C after exposing them for 1,000 hours 85°C without voltage applied. Before the measurement, the capacitor shall be preconditioned by applying voltage according to them 4.1 of JIS C5101-4.										
	Capacitance Change	Within ± 20% of Initial Value									
	tan δ	200% or less of Initial Specified Value									
	Leakage Current	Initial Specified Value or less									
Standards 參照標準	JIS C 5101-4 (IEC 60384)										

Frequency Coefficient of Permissible Ripple Current

Rated Voltage (V)	Capacitance (µF)	Frequency (Hz)			
		50	120	1K	≤20K
≤ 100	< 100	0.75	1.00	1.57	2.00
	100 ~ 470	0.80	1.00	1.34	1.50
	> 470	0.85	1.00	1.10	1.15
≥ 160	0.1 ~ 220	0.80	1.00	1.40	1.60
	330 ~ 1000	0.90	1.00	1.13	1.15

The endurance of capacitors is reduced with internal heating produced by ripple current at the rate of halving the lifetime with every 10°C rise. When long life performance is required in actual use, the rms ripple current has to be reduced.

SL

SL series

DIMENSIONS(mm)

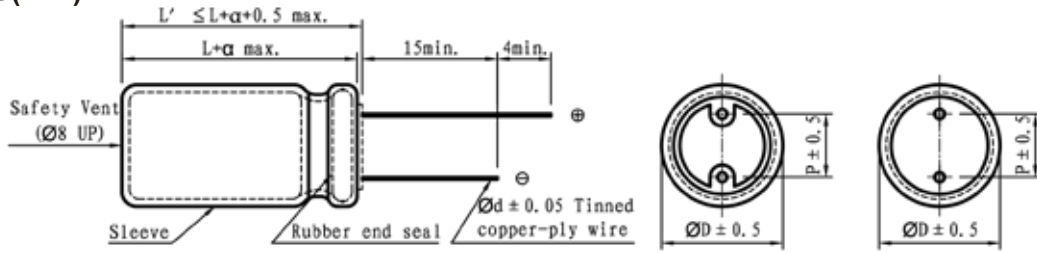

ϕD	5	6.3	8	10	13	16	18	22	25
P	2.0	2.5	3.5	5.0	5.0	7.5	7.5	10	12.5
ϕd	0.5	0.5	0.5	0.6	0.6	0.8	0.8	0.8	1.0

α	(L < 16) 1.0
	(L ≥ 16) 2.0

STANDARD RATINGS

D×L(mm) ; R.C.(mA rms) at 85°C 120Hz.

Cap (μF)	V	6.3		10		16		25		35		50		63		100		
		Item	D x L	R.C.	D x L	R.C.	D x L	R.C.	D x L	R.C.	D x L	R.C.	D x L	R.C.	D x L	R.C.	D x L	R.C.
22																	8x12	151
33																	8x9	180
																	10x13	204
47														8x9	193	10x16	266	
														8x12	218			
68										8x12	206	8x12	249	8x12	278	10x20	315	
100										8x12	278	8x9	275	8x14	363	10x20	459	
												8x12	303					
220								8x12	387	8x9	362	10x16	532	10x16	593	13x25	726	
											10x13							448
330						8x12	436	8x9	442	10x16	593	10x20	702	10x20	823	16x26	907	
							8x14	508										
470		8x12	460	8x12	484	8x9	508	10x16	653	10x16	774	13x13	808	13x21	1065	16x32	1113	
					8x12	569	13x21					920						
1000		8x9	617	10x13	762	10x16	956	10x20	1150	13x21	1331	13x25	1634	16x26	1755	18x40	1573	
		10x13	702															
1500		10x16	788	10x20	823	10x20	1101	13x21	1367	13x25	1597	16x32	1925	18x32	2310	22x40	2145	
2200		10x16	1150	10x20	1331	13x21	1634	13x25	1876	16x26	2178	16x36	2541	18x35	2783	25x50	2432	
3300		10x20	1513	13x21	1694	13x25	2057	16x26	2118	16x32	2686	18x35	3037	22x40	3267			
		13x13	1392															
4700		13x21	1815	13x25	2178	16x26	2420	16x32	2614	18x35	3110	22x40	3630	22x50	4114			
6800		13x25	2299	16x26	2481	16x32	2783	18x35	3207	22x40	3884	22x50	4235	25x50	4719			
10000		16x26	2481	16x36	3025	18x35	3485	22x40	4380	22x50	4719	25x50	4840					
15000		16x36	3243	18x35	3775	22x40	4659	22x50	5082	25x50	5203							
22000		18x40	3896	22x40	4489	22x50	5336	25x50	5445									
33000		22x50	4719	22x50	5445	25x50	5808											

※ 13mm may be replaced by 12.5mm upon customer's request.

SL

SL series

STANDARD RATINGS

D×L(mm) ; R.C.(mA rms)at 85°C 120Hz.

Cap (μF)	V Item	160		200		250		350	
		D x L	R.C.	D x L	R.C.	D x L	R.C.	D x L	R.C.
1.0								8x12	28
2.2						8x12	36	8x12	37
3.3		8x12	42	8x12	50	8x12	55	10x13	56
4.7		8x12	56	8x12	62	10x13	67	10x16	70
10		10x13	97	10x16	105	10x16	110	10x20	120
22		10x16	157	10x20	165	13x13	169	13x13	169
						13x21	195	13x21	210
33		10x20	230	13x13	212	13x21	245	16x26	280
47		13x13	254	13x21	310	13x21	320	16x36	380
		13x21	290						
100		16x26	520	16x26	550	16x32	570	18x40	600
220		16x36	860	22x30	980	22x30	1070	22x50	1210
330		18x40	1210	22x35	1280	22x35	1320		
470		22x40	1320	22x50	1360	25x50	1500		
1000		22x50	1720						

Cap (μF)	V Item	400		450		500	
		D x L	R.C.	D x L	R.C.	D x L	R.C.
1.0		8x12	23	8x12	25		
2.2		10x13	35	10x13	36	10x13	32
3.3		10x13	45	10x16	50	10x16	45
4.7		10x16	55	10x20	62	10x20	55
10		13x21	85	13x21	93	13x21	65
22		16x26	160	16x26	172	16x26	135
33		16x32	195	16x36	210	16x36	155
47		16x36	275	18x40	285	18x40	235
100		22x35	500	22x40	520	22x40	450
220		25x50	970				

※ 13mm may be replaced by 12.5mm upon customer's request.

LF series

- Long life of SL series.
- Suitable for LCD TV Power, SMPS.
- RoHS Compliance.
- SL系列壽命提升品。
- 適用於液晶顯示電源及開關電源等。



SPECIFICATIONS

Items 項目	Characteristics 特性				
Capacitance Tolerance 靜電容量誤差	± 20%(120Hz,20°C)				
Operating Temperature Range 適用溫度範圍	-40 ~ +85°C		-25 ~ +85°C		
Rated Voltage Range 額定電壓範圍	400 ~ 420VDC		450 ~ 500VDC		
Leakage Current 洩漏電流	$I \leq 0.03CV + 20 (\mu A)$ (After 3 minutes application of DC rated voltage, at 20 °C)				
Dissipation Factor 散逸因素(tan δ)	Measurement Frequency: 120Hz. Temperature: 20°C				
	Rated Voltage(V)	400~420	450	460	500
	tan δ (Max)	0.15	0.20	0.20	0.20
	When nominal capacitance over 1000 μ F, tan δ shall be added 0.02 to the listed value with increase of every 1000 μ F .				
Low Temperature Stability 低溫特性 Impedance Ratio(Max) 阻抗比率(最大值)	Measurement Frequency: 120Hz.				
	Rated Voltage(V)	400~420	450	460	500
	Z(-25°C)/Z(20°C)	3	3	6	6
	Z(-40°C)/Z(20°C)	6	-	-	-
Load Life 負荷壽命	The following specifications shall be satisfied when the capacitors are restored to 20°C after subjected to DC voltage with the rated ripple current is applied for 8,000 hours at 85°C.				
	Capacitance Change	Within ± 20% of Initial Value			
	tan δ	200% or less of Initial Specified Value			
	Leakage Current	Initial Specified Value or less			
Shelf Life 放置壽命	The following specifications shall be satisfied when the capacitors are restored to 20°C after exposing them for 1,000 hours 85°C without voltage applied. Before the measurement. The capacitor shall be preconditioned by applying voltage according to them 4.1 of JIS C5101-4.				
	Capacitance Change	Within ± 20% of Initial Value			
	tan δ	200% or less of Initial Specified Value			
	Leakage Current	Initial Specified Value or less			
Standards 參照標準	JIS C 5101-4-1 (IEC 60384)				

Frequency Coefficient of Permissible Ripple Current

Capacitance (μ F)	Frequency (Hz)				
	120	10K	30K	50K	100K
10 ~ 150	1.00	1.50	1.60	1.75	2.00

The endurance of capacitors is reduced with internal heating produced by ripple current at the rate of halving the lifetime with every 10°C rise. When long life performance is required in actual use . The rms ripple current has to be reduced.

LF series

DIMENSIONS(mm)

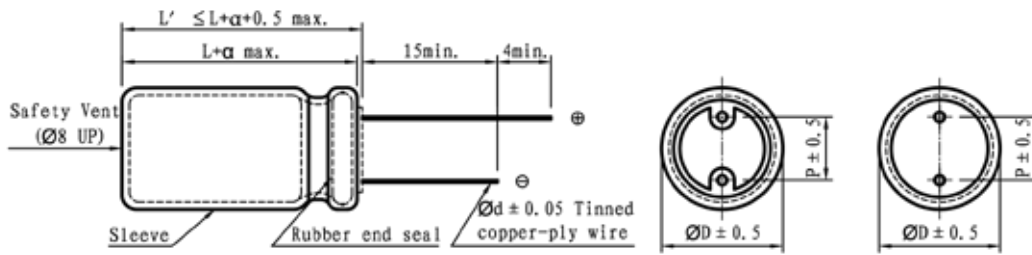

ϕD	10	13	16	18	20
P	5.0	5.0	7.5	7.5	10
ϕd	0.6	0.6	0.8	0.8	0.8

α	(L < 16) 1.0 (L \geq 16) 2.0
----------	-----------------------------------

STANDARD RATINGS

D×L(mm) ; R.C.(mA rms) at 85°C 120Hz.

Cap (μF)	V	400				420				450			
		Item	D x L	R.C.		D x L	R.C.		D x L	R.C.			
				120Hz	100KHz		120Hz	100KHz		120Hz	100KHz		
10		10x16	150	300	10x20	180	360	10x20	150	300			
22		13x21	300	600	13x25	330	660	13x25	330	660			
47		13x25	350	700	16x22	400	800	16x26	380	760			
56		16x25	480	960	16x25	500	1000	16x32	450	900			
68		16x32	563	1126	16x32	550	1100	16x36	530	1060			
82		16x35	650	1300	16x36	630	1260	16x40	600	1200			
100		16x40	780	1560	16x40	750	1500	16x45	720	1440			
120		16x45	889	1778	16x45	840	1680	16x50	840	1680			
150		16x50	980	1960	16x50	920	1840						

Cap (μF)	V	460				500			
		Item	D x L	R.C.		D x L	R.C.		
				120Hz	100KHz		120Hz	100KHz	
10		13x16	120	240	13x16	115	230		
22		16x25	250	500	16x25	230	460		
47		16x36	450	900	16x36	435	870		
56		16x40	500	1000	16x40	491	982		
68		16x45	580	1160	16x45	563	1126		
82		16x50	650	1300	16x50	630	1260		
100		18x45	730	1460	18x45	700	1400		
120		20x45	800	1600					

※ 13mm may be replaced by 12.5mm upon customer's request.



SK series

- 105°C 2000hours, standard product.
- RoHS Compliance
- 105°C 2000小時標準品



SPECIFICATIONS

Items 項目	Characteristics 特性											
Capacitance Tolerance 靜電容量誤差	± 20%(120Hz,20°C)											
Operating Temperature Range 適用溫度範圍	-40 ~ +105°C				-40 ~ +105°C				-25 ~ +105°C			
Rated Voltage Range 額定電壓範圍	6.3 ~ 100VDC				160 ~ 250VDC				350 ~ 500VDC			
Leakage Current 洩漏電流	I ≤ 0.01CV or 3 (µA) which is greater.(After 2 minutes application of DC rated voltage, at 20 °C)						I ≤ 0.03CV +20 (µA) (After 3 minutes application of DC rated voltage, at 20 °C)					
Dissipation Factor 散逸因素(tan δ)	Measurement Frequency: 120Hz. Temperature: 20°C											
	Rated Voltage(V)	6.3	10	16	25	35	50	63	80	100	160~250	350~500
	tan δ(Max)	0.24	0.20	0.16	0.15	0.12	0.10	0.09	0.08	0.08	0.20	0.25
When nominal capacitance over 1000µF, tanδ shall be added 0.02 to the listed value with increase of every 1000µF .												
Low Temperature Stability 低溫特性 Impedance Ratio(Max) 阻抗比率(最大值)	Measurement Frequency: 120Hz.											
	Rated Voltage(V)	6.3	10	16	25	35	50~100	160~250	350~400	450~500		
	Z(-25°C)/Z(20°C)	5	4	3	2	2	2	3	6	15		
Z(-40°C)/Z(20°C)	10	8	6	4	3	3	4	-	-			
Load Life 負荷壽命	The following specifications shall be satisfied when the capacitors are restored to 20°C after subjected to DC voltage with the rated ripple current is applied for 2,000 hours at 105°C.											
	Capacitance Change	Within ± 20% of Initial Value										
	tan δ	200% or less of Initial Specified Value										
	Leakage Current	Initial Specified Value or less										
Shelf Life 放置壽命	The following specifications shall be satisfied when the capacitors are restored to 20°C after exposing them for 1,000 hours 105°C without voltage applied. Before the measurement, the capacitor shall be preconditioned by applying voltage according to them 4.1 of JIS C5101-4.											
	Capacitance Change	Within ± 20% of Initial Value										
	tan δ	200% or less of Initial Specified Value										
	Leakage Current	Initial Specified Value or less										
Standards 參照標準	JIS C 5101-4 (IEC 60384)											

Frequency Coefficient of Permissible Ripple Current

Rated Voltage (V)	Capacitance (µF)	Frequency (Hz)			
		50	120	1K	≥20K
≤ 100	< 100	0.75	1.00	1.40	1.50
	100 ~ 470	0.75	1.00	1.20	1.30
	> 470	0.85	1.00	1.10	1.15
≥ 160	0.47 ~ 470	0.75	1.00	1.10	1.50

The endurance of capacitors is reduced with internal heating produced by ripple current at the rate of halving the lifetime with every 5°C rise. When long life performance is required in actual use , the rms ripple current has to be reduced.

SK series

DIMENSIONS(mm)

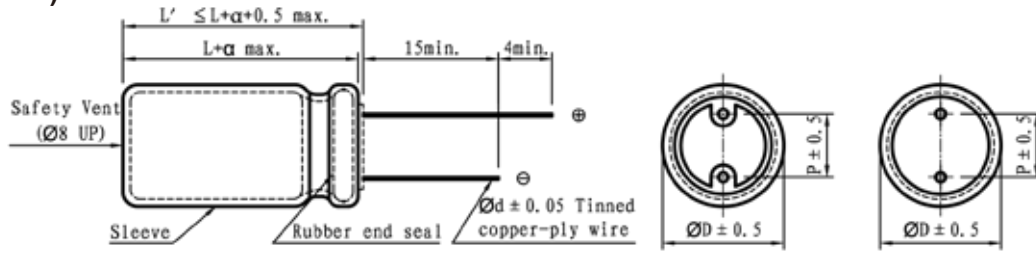

φD	5	6.3	8	10	13	14.5	16	18	22	25
P	2.0	2.5	3.5	5.0	5.0	7.5	7.5	7.5	10	12.5
φd	0.5	0.5	0.5	0.6	0.6	0.8	0.8	0.8	0.8	1.0

STANDARD RATINGS

D×L(mm) ; R.C.(mA rms) at 105°C 120Hz.

Cap (μF)	V	6.3		10		16		25		35		50		63		100	
		Item	D x L	R.C.	D x L	R.C.	D x L	R.C.	D x L	R.C.	D x L	R.C.	D x L	R.C.	D x L	R.C.	D x L
0.1~0.47												5x11	11	5x11	12	5x11	17
1												5x11	15	5x11	17	5x11	20
2.2												5x11	24	5x11	25	5x11	30
3.3												5x11	30	5x11	31	5x11	36
4.7								5x11	30	5x11	31	5x11	36	5x11	37	5x11	44
6.8								5x11	35	5x11	37	5x11	46	5x11	51	5x11	45
10						5x11	42	5x11	43	5x11	47	5x11	54	5x11	58	6.3x11	75
22	5x11	54	5x11	59	5x11	63	5x11	65	5x11	75	5x11	83	6.3x11	109	8x12	112	
33	5x11	66	5x11	77	5x11	79	5x11	83	5x11	91	6.3x11	107	8x12	121	8x12	133	
47	5x11	78	5x11	87	5x11	94	5x11	97	6.3x11	116	6.3x11	145	8x12	163	10x13	170	
56	5x11	90	5x11	100	5x11	105	5x11	109	6.3x11	127	6.3x11	151	8x12	172	10x16	187	
68	5x11	102	5x11	119	5x11	145	5x11	151	6.3x11	169	6.3x11	196	8x12	206	10x16	238	
100	5x11	111	5x11	139	6.3x11	151	6.3x11	163	8x12	194	8x14	242	10x13	254	10x20	315	
220	5x11	175	6.3x11	212	8x12	237	8x12	290	10x13	332	10x16	363	10x20	436	13x25	581	
330	6.3x11	233	6.3x11	272	8x12	321	10x13	369	10x16	484	10x20	514	13x21	666	16x26	714	
470	6.3x11	266	8x12	299	8x14	381	8x16	436	10x20	581	13x21	762	13x25	847	16x32	968	
560	8x12	272	8x12	306	8x14	387	10x16	448	10x20	629	13x21	774	13x25	871	16x36	1012	
680	8x12	278	8x12	319	8x16	424	10x20	581	13x21	702	13x25	799	16x26	1004	18x32	1210	
1000	8x14	484	10x13	586	10x16	617	10x20	750	13x21	908	13x25	1089	16x32	1210	18x35	1573	
1500	8x20	545	10x20	592	10x20	641	13x21	787	13x25	1041	16x32	1452	18x32	1718			
2200	10x20	774	10x20	918	13x21	1004	13x25	1132	16x26	1343	16x36	1609	18x35	1997			
3300	10x20	908	13x21	1091	13x25	1222	16x26	1428	16x36	1730	18x35	1997	22x40	2347			
4700	13x21	1162	13x25	1306	16x26	1464	16x32	1718	18x35	2057	22x40	2541	22x50	2965			
6800	13x25	1385	16x26	1770	16x36	1863	18x35	2202	22x40	2602	22x50	3025					
10000	16x26	1730	16x36	2236	18x35	2335	22x40	2589	22x50	3207							
15000	16x36	2214	18x35	2808	22x40	2928	22x50	3328									
22000	18x40	2771	22x40	3514	22x50	3630											

Cap (μF)	V	160		200		250		350		400		450		500	
		Item	D x L	R.C.	D x L	R.C.	D x L	R.C.	D x L	R.C.	D x L	R.C.	D x L	R.C.	
2.2	6.3x11	35	6.3x11	35	8x12	72	8x12	56	10x13	54	10x16	75			
3.3	8x12	72	8x12	72	8x12	78	10x13	85	10x13	69	10x16	102	10x20	42	
4.7	8x12	75	8x12	75	10x13	110	10x13	90	10x16	120	10x20	130	10x20	56	
6.8	8x12	78	8x12	78	10x13	120	10x13	95	10x16	125	13x21	155	13x21	105	
10	10x13	92	10x16	145	10x16	145	10x20	150	10x20	145	13x21	165	13x21	110	
22	10x16	145	10x20	210	13x21	245	13x25	225	13x25	252	16x26	360	16x26	250	
33	10x20	210	13x21	245	13x21	255	13x25	245	16x26	380	16x26	380	16x32	280	
47	13x21	245	13x25	330	13x25	350	16x26	405	16x26	395	16x32	450	18x35	320	
68	13x21	255	13x25	340	16x26	540	16x32	450	16x32	475	18x32	585	18x45	360	
82	13x25	350	13x25	350	16x26	550	16x32	480	18x26	480	18x35	650			
100	16x26	530	16x26	540	16x32	630	18x32	580	18x32	580	18x40	720			
120	16x26	540	16x26	550	16x32	650	18x35	650	18x35	650	18x40	750			
150	16x26	550	16x32	650	18x32	730	18x40	750	18x40	720	22x45	785			
220	16x36	720	18x32	750	22x35	950									
330	18x35	810	22x35	860											
470	18x40	1050	22x40	1100											

※ 13mm may be replaced by 12.5mm upon customer's request.

SK

SK series

SLIM TYPE

- 105°C high-temperature and high voltage 400~500V, life 2000hrs.
- Specially Size, 8~16mm diameter.
- For LCD-TV and LCD-Monitor power.
- RoHS Compliance.
- 105°C 耐高温標準品，高壓400~500V，壽命2000小時。
- 特殊專用尺寸，直徑8~16mm。
- 使用於LCD TV與LCD Monitor電源應用。



SPECIFICATIONS

D×L(mm) ; R.C.(mA rms) at 105°C 120Hz.

Cap (µF)	V Item	400		450		500	
		D x L	R.C.	D x L	R.C.	D x L	R.C.
22		8x50	158	8x50	168	13x40	158
		10x30	150	10x35	153		
33		8x61	210	8x61	218	13x45	162
		10x40	192	10x45	198		
39		8x61	258	8x61	287	14.5x45	160
		10x45	235	10x50	250		
		13x35	250	13x40	265		
47		10x50	285	10x50	335	14.5x45	163
		13x40	282	13x45	305	16x50	175
		14.5x30	278	14.5x30	290		
53		10x50	305	10x50	400	16x50	178
68		13x45	340	14.5x40	460		
		14.5x30	330	16x35	490		
82		13x50	365	14.5x50	460		
		14.5x40	385	16x40	490		
100		14.5x45	468	14.5x50	620		
				16x50	640		
120		14.5x50	550	16x50	650		

※ 13mm may be replaced by 12.5mm upon customer's request.

SKA series

- On the basis of SK series ripple promotion product.
- Suitable for LCD TV Power, SMPS.
- RoHS Compliance.
- SK系列紋波提升品。
- 適用於液晶顯示電源及開關電源等。



SPECIFICATIONS

Items 項目	Characteristics 特性				
Capacitance Tolerance 靜電容量誤差	± 20%(120Hz,20°C)				
Operating Temperature Range 適用溫度範圍	-40 ~ +105°C		-25 ~ +105°C		
Rated Voltage Range 額定電壓範圍	400VDC		450 ~ 500VDC		
Leakage Current 洩漏電流	$I \leq 0.03CV + 20 (\mu A)$ (After 3 minutes application of DC rated voltage, at 20 °C)				
Dissipation Factor 散逸因素(tan δ)	Measurement Frequency: 120Hz. Temperature: 20°C				
	Rated Voltage(V)	400	450	460	500
	tan δ (Max)	0.15	0.20	0.20	0.20
	When nominal capacitance over 1000 μ F, tan δ shall be added 0.02 to the listed value with increase of every 1000 μ F .				
Low Temperature Stability 低溫特性 Impedance Ratio(Max) 阻抗比率(最大值)	Measurement Frequency: 120Hz.				
	Rated Voltage(V)	400	450	460	500
	Z(-25°C)/Z(20°C)	3	3	6	6
	Z(-40°C)/Z(20°C)	6	-	-	-
Load Life 負荷壽命	The following specifications shall be satisfied when the capacitors are restored to 20°C after subjected to DC voltage with the rated ripple current is applied for 2,000 hours at 105°C.				
	Capacitance Change	Within ± 20% of Initial Value			
	tan δ	200% or less of Initial Specified Value			
	Leakage Current	Initial Specified Value or less			
Shelf Life 放置壽命	The following specifications shall be satisfied when the capacitors are restored to 20°C after exposing them for 1,000 hours 105°C without voltage applied. Before the measurement. The capacitor shall be preconditioned by applying voltage according to them 4.1 of JIS C5101-4.				
	Capacitance Change	Within ± 20% of Initial Value			
	tan δ	200% or less of Initial Specified Value			
	Leakage Current	Initial Specified Value or less			
Standards 參照標準	JIS C 5101-4-1 (IEC 60384)				

SKA

Frequency Coefficient of Permissible Ripple Current

Capacitance (μ F)	Frequency (Hz)				
	120	10K	30K	50K	100K
10 ~ 150	1.00	1.50	1.60	1.75	2.00

The endurance of capacitors is reduced with internal heating produced by ripple current at the rate of halving the lifetime with every 5°C rise. When long life performance is required in actual use . The rms ripple current has to be reduced.

SKA series

DIMENSIONS(mm)

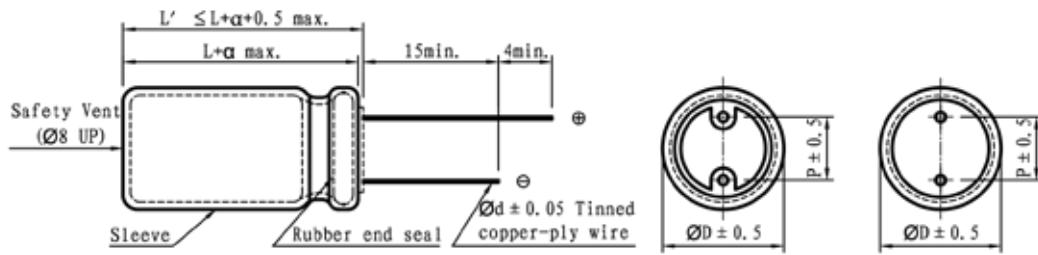

ϕD	10	13	16	18	20	22
P	5.0	5.0	7.5	7.5	10	10
ϕd	0.6	0.6	0.8	0.8	0.8	0.8

α	(L < 16) 1.0 (L ≥ 16) 2.0
----------	------------------------------

STANDARD RATINGS

D×L(mm) ; R.C.(mA rms) at 105°C 120Hz.

Cap (μF)	V	400				450				460				500			
		Item	D x L	R.C.		D x L	R.C.		D x L	R.C.		D x L	R.C.				
				120Hz	100KHz		120Hz	100KHz		120Hz	100KHz		120Hz	100KHz			
10		10x16	100	200	10x20	130	260	10x20	120	240	13x21	78	156				
15		10x20	200	400	13x21	200	400	13x21	150	300	13x21	100	200				
22		13x21	280	560	13x21	300	600	13x25	300	600	13x25	190	380				
33		13x21	330	660	13x25	400	800	16x25	400	800	16x25	270	540				
47		13x25	380	760	16x25	500	1000	18x26	500	1000	18x26	300	600				
56		16x25	500	1000	18x26	600	1200	18x26	550	1100	18x32	330	660				
68		16x25	650	1300	18x32	690	1380	18x32	600	1200	18x35	450	900				
82		18x26	750	1500	18x32	750	1500	18x32	650	1300	18x40	560	1120				
100		18x32	800	1600	18x35	780	1560	18x35	750	1500	18x45	650	1300				
120		18x35	850	1700	18x40	850	1700	18x40	800	1600	20x45	700	1400				
150		18x40	900	1800	18x45	900	1800	20x45	827	1654	22x45	750	1500				

※ 13mm may be replaced by 12.5mm upon customer's request.

SKA

SKR series

- 105°C high-temperature resistance, high ripple current.
- RoHS Compliance.
- 105°C耐高温、高紋波。



SPECIFICATIONS

Items 項目	Characteristics 特性			
Capacitance Tolerance 靜電容量誤差	± 20%(120Hz,20°C)			
Operating Temperature Range 適用溫度範圍	-40 ~ +105°C		-25 ~ +105°C	
Rated Voltage Range 額定電壓範圍	160 ~ 400VDC		450VDC	
Leakage Current 洩漏電流	$I \leq 0.03CV + 20 (\mu A)$ (After 3 minutes application of DC rated voltage)			
Dissipation Factor 散逸因素(tan δ)	Measurement Frequency: 120Hz. Temperature: 20°C			
	Rated Voltage(V)	160~250	400~450	
	tan δ (Max)	0.15	0.20	
Low Temperature Stability 低溫特性 Impedance Ratio(Max) 阻抗比率(最大值)	Measurement Frequency: 120Hz.			
	Rated Voltage(V)	160~250	400	450
	Z(-25°C)/Z(20°C)	3	5	6
	Z(-40°C)/Z(20°C)	6	6	-
Load Life 負荷壽命	The following specifications shall be satisfied when the capacitors are restored to 20°C after subjected to DC voltage with the rated ripple current is applied for 2,000 hours at 105°C.			
	Capacitance Change	Within ± 20% of Initial Value		
	tan δ	200% or less of Initial Specified Value		
	Leakage Current	Initial Specified Value or less		
Shelf Life 放置壽命	The following specifications shall be satisfied when the capacitors are restored to 20°C after exposing them for 1,000 hours 105°C without voltage applied. Before the measurement, the capacitor shall be preconditioned by applying voltage according to them 4.1 of JIS C5101-4.			
	Capacitance Change	Within ± 20% of Initial Value		
	tan δ	200% or less of Initial Specified Value		
	Leakage Current	Initial Specified Value or less		
Standards 參照標準	JIS C 5101-4 (IEC 60384)			

Frequency Coefficient of Permissible Ripple Current

Capacitance (μF)	Frequency (Hz)			
	120	1K	10K	100K
22~82	1.00	1.25	1.50	1.75
100~470	1.00	1.15	1.30	1.40

The endurance of capacitors is reduced with internal heating produced by ripple current at the rate of halving the lifetime with every 5°C rise. When long life performance is required in actual use , the rms ripple current has to be reduced.

SKR series

DIMENSIONS(mm)

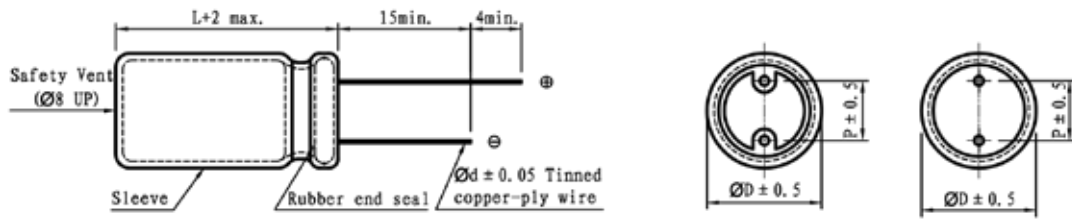

ϕ D	10	13	14.5	16	18	20
P	5.0	5.0	7.5	7.5	7.5	10.0
ϕ d	0.6	0.6	0.8	0.8	0.8	0.8

STANDARD RATINGS

D×L(mm) ; R.C.(mA rms) at 105°C 120Hz.

Cap (μF)	V	160		200		250		400		450	
		Item	D x L	R.C.	D x L	R.C.	D x L	R.C.	D x L	R.C.	D x L
22								10x30	260	10x35	280
33								10x40	360	13x30	375
39								10x45	405	13x35	415
47								13x35	443	13x40	465
										14.5x30	465
56								13x40	510	14.5x35	520
										16x30	520
68	10x25	375	10x30	485	13x25	530		13x45	580	14.5x40	600
								14.5x30	580	16x35	600
82	10x30	485	10x35	528	13x30	595		14.5x40	635	16x40	650
										18x32	650
100	10x35	528	10x40	615	16x25	650		14.5x45	690	18x36	700
								18x32	690		
120	10x40	615	10x45	710	16x32	715		16x40	810	18x40	820
								18x36	810		
150	10x45	710	13x35	780	16x35	860		18x40	940	18x45	990
										20x40	1000
220	13x40	880	13x45	995	18x36	1120					
			14.5x35	995							
270	13x45	995	16x35	1150	18x40	1200					
330	16x35	1150	16x40	1320							
			18x32	1320							
470	18x40	1270	18x45	1660							

※ 13mm may be replaced by 12.5mm upon customer's request.

SKR

UK series

- High-temperature resistance, high ripple current.
- 105°C for general purposes, 3000 hours standard product.
- RoHS Compliance
- 耐高溫、高紋波。
- 105°C 3000hours 標準品

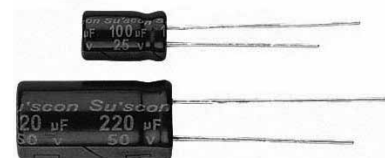

SPECIFICATIONS

Items 項目	Characteristics 特性											
Capacitance Tolerance 靜電容量誤差	± 20%(120Hz,20°C)											
Operating Temperature Range 適用溫度範圍	-40 ~ +105°C				-40 ~ +105°C				-25 ~ +105°C			
Rated Voltage Range 額定電壓範圍	6.3 ~ 100VDC				160 ~ 250VDC				350 ~ 450VDC			
Leakage Current 洩漏電流	I ≤ 0.01CV or 3 (µA) which is greater. (After 2 minutes application of DC rated voltage, at 20 °C)						I ≤ 0.03CV +20 (µA) (After 3 minutes application of DC rated voltage, at 20 °C)					
Dissipation Factor 散逸因素(tan δ)	Measurement Frequency: 120Hz. Temperature: 20°C											
	Rated Voltage(V)	6.3	10	16	25	35	50	63	80	100	160~250	350~450
	tan δ(Max)	0.24	0.20	0.16	0.15	0.12	0.10	0.09	0.08	0.08	0.20	0.25
	When nominal capacitance over 1000µF, tanδ shall be added 0.02 to the listed value with increase of every 1000µF .											
Low Temperature Stability 低溫特性 Impedance Ratio(Max) 阻抗比率(最大值)	Measurement Frequency: 120Hz.											
	Rated Voltage(V)	6.3	10	16	25	35	50~100	160~250	350~400	450		
	Z(-25°C)/Z(20°C)	5	4	3	2	2	2	3	6	15		
	Z(-40°C)/Z(20°C)	10	8	6	4	3	3	4	-	-		
Load Life 負荷壽命	The following specifications shall be satisfied when the capacitors are restored to 20°C after subjected to DC voltage with the rated ripple current is applied for 3,000 hours at 105°C.											
	Capacitance Change	Within ± 20% of Initial Value										
	tan δ	200% or less of Initial Specified Value										
	Leakage Current	Initial Specified Value or less										
Shelf Life 放置壽命	The following specifications shall be satisfied when the capacitors are restored to 20°C after exposing them for 1,000 hours 105°C without voltage applied. Before the measurement, the capacitor shall be preconditioned by applying voltage according to them 4.1 of JIS C5101-4.											
	Capacitance Change	Within ± 20% of Initial Value										
	tan δ	200% or less of Initial Specified Value										
	Leakage Current	Initial Specified Value or less										
Standards 參照標準	JIS C 5101-4 (IEC 60384)											

Frequency Coefficient of Permissible Ripple Current

Rated Voltage (V)	Capacitance (µF)	Frequency (Hz)			
		50	120	1K	≥20K
≤ 100	< 100	0.75	1.00	1.57	2.00
	100 ~ 470	0.80	1.00	1.34	1.50
	> 470	0.85	1.00	1.10	1.15
≥ 160	0.47 ~ 1000	0.85	1.00	1.40	1.50

The endurance of capacitors is reduced with internal heating produced by ripple current at the rate of halving the lifetime with every 5°C rise. When long life performance is required in actual use , the rms ripple current has to be reduced.

UK series

DIMENSIONS(mm)

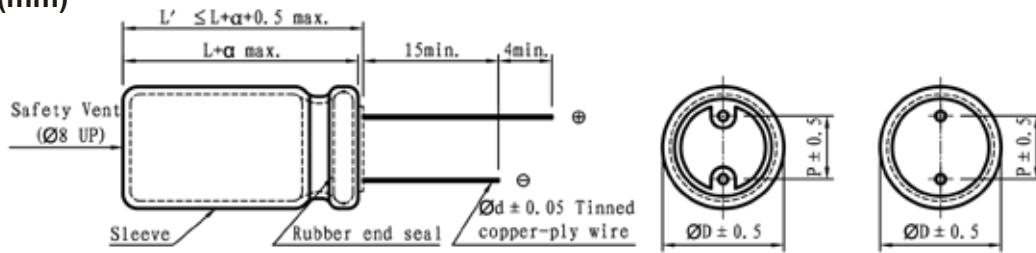

ϕD	5	6.3	8	10	13	16	18	20	22
P	2.0	2.5	3.5	5.0	5.0	7.5	7.5	10	10
ϕd	0.5	0.5	0.5	0.6	0.6	0.8	0.8	0.8	0.8

α	(L < 16) 1.0
	(L ≥ 16) 2.0

STANDARD RATINGS

D×L(mm) ; R.C.(mA rms) at 105°C 120Hz.

Cap (μF)	V	6.3		10		16		25		35		50		63	
		Item	D x L	R.C.	D x L	R.C.	D x L	R.C.	D x L	R.C.	D x L	R.C.	D x L	R.C.	D x L
0.1~0.47												5x11	12		
1												5x11	16		
2.2												5x11	25		
3.3												5x11	35		
4.7								5x11	32	5x11	33	5x11	38		
6.8								5x11	37	5x11	39	5x11	50	5x11	52
10						5x11	44	5x11	45	5x11	49	5x11	56	5x11	68
22	5x11	56	5x11	61	5x11	65	5x11	67	5x11	76	5x11	89	6.3x11	112	
33	5x11	68	5x11	79	5x11	81	5x11	85	5x11	93	6.3x11	130	8x12	145	
47	5x11	80	5x11	89	5x11	97	5x11	100	6.3x11	133	6.3x11	152	8x12	174	
56	5x11	92	5x11	103	5x11	107	5x11	121	6.3x11	136	6.3x11	171	8x12	187	
68	5x11	105	5x11	121	5x11	150	5x11	158	6.3x11	173	6.3x11	208	8x12	234	
100	5x11	113	5x11	145	6.3x11	157	6.3x11	179	8x12	197	8x14	270	10x13	292	
220	5x11	176	6.3x11	223	8x12	248	8x12	318	10x13	347	10x16	583	10x20	693	
330	6.3x11	240	6.3x11	275	8x12	361	10x13	391	10x16	490	10x20	737	13x21	770	
470	6.3x11	292	8x12	339	8x14	427	8x16	523	10x16	627	13x21	902	13x25	1012	
560	8x12	350	8x12	443	8x14	475	10x16	594	10x20	644	13x21	963	13x25	1177	
680	8x12	413	8x12	538	8x16	548	10x20	704	13x21	770	13x25	1040	16x26	1337	
1000	8x14	502	10x13	645	10x16	768	10x20	919	13x21	1194	13x25	1485	16x32	1848	
1500	10x16	669	10x20	798	10x20	993	13x21	1155	13x25	1370	16x32	1810	18x32	1975	
2200	10x20	912	10x20	988	13x21	1231	13x25	1447	16x26	1678	16x36	2200	18x35	2288	
3300	10x20	1154	13x21	1395	13x25	1560	16x26	1847	16x36	2145	18x35	2541	22x40	2695	
4700	13x21	1447	13x25	1671	16x26	1958	16x32	2310	18x35	2640	22x40	2915	22x50	3069	
6800	13x25	1795	16x26	2056	16x36	2374	18x35	2767	22x40	2761	22x50	3080			
10000	16x26	2112	16x36	2265	18x35	2903	22x40	2860	22x50	3210					
15000	16x36	2629	18x35	2820	22x40	2991	22x50	3350							
22000	18x40	2805	22x40	3620	22x50	3650									

Cap (μF)	V	100		160		200		250		350		400		450	
		Item	D x L	R.C.	D x L	R.C.	D x L	R.C.	D x L	R.C.	D x L	R.C.	D x L	R.C.	D x L
0.1		5x11	1.7												
0.22		5x11	3.7												
0.33		5x11	5.5												
0.47		5x11	12	6.3x11	22	6.3x11	22	6.3x11	26	6.3x11	24	8x12	26	8x12	25
1		5x11	18	6.3x11	30	6.3x11	25	6.3x11	28	8x12	45	8x12	46	10x16	75
2.2		5x11	28	6.3x11	35	6.3x11	30	8x12	62	8x12	62	8x12	70	10x16	80
3.3		5x11	40	8x12	65	8x12	70	8x12	75	10x13	90	10x13	105	10x20	125
4.7		5x11	46	8x12	70	8x12	75	10x13	120	10x13	95	10x16	130	10x20	135
6.8		5x11	54	8x12	75	8x12	85	10x13	125	10x13	105	10x16	150	13x21	165
10		6.3x11	69	10x13	90	10x16	140	10x16	150	10x20	145	10x20	175	13x21	175
22		8x12	127	10x16	145	10x20	200	13x21	250	13x25	245	13x25	280	16x26	410
33		8x12	167	10x20	200	13x21	250	13x21	260	16x26	420	16x26	420	16x32	470
47		10x16	231	13x21	240	13x25	340	13x25	350	16x26	450	16x26	470	18x32	540
68		10x16	271	13x21	303	13x25	360	16x26	540	16x32	490	16x32	510	18x35	570
82		10x16	299	13x25	365	13x25	385	16x26	550	16x32	510	18x32	580	18x35	590
100		10x20	402	16x26	520	16x26	550	16x32	630	18x32	620	18x35	650	18x40	750
120		10x25	457	16x26	550	16x26	570	16x32	650	18x35	650	18x40	780	18x45	820
150		13x21	579	16x26	580	16x32	650	18x32	720	18x40	850	22x40	920		
220		13x25	762	16x26	660	18x35	800	18x40	850						
330		16x26	952	18x35	957	22x35	1100								
470		16x32	1238	18x40	1100	22x40	1238								
1000		18x35	2321	22x50	1760										

※ 13mm may be replaced by 12.5mm upon customer's request.

UK

SE series

- 105°C high-temperature, high reliability and long life.
- Suitable for office communicative or industrial equipments.
- RoHS Compliance.
- 105°C耐高温、高信頼性、長寿命產品。
- 適用於辦公室通訊設備、工業設備。



SPECIFICATIONS

Items 項目	Characteristics 特性											
Capacitance Tolerance 靜電容量誤差	± 20%(120Hz,20°C)											
Operating Temperature Range 適用溫度範圍	- 40 ~ +105°C				- 40 ~ +105°C				-25 ~ +105°C			
Rated Voltage Range 額定電壓範圍	6.3 ~ 100VDC				160 ~ 250VDC				350 ~ 450VDC			
Leakage Current 洩漏電流	I ≤ 0.01CV or 3 (µA) which is greater.(After 2 minutes application of DC rated voltage, at 20 °C)						I ≤ 0.03CV +20 (µA) (After 3 minutes application of DC rated voltage, at 20 °C)					
Dissipation Factor 散逸因素(tan δ)	Measurement Frequency: 120Hz. Temperature: 20°C											
	Rated Voltage(V)	6.3	10	16	25	35	50	63	100	160~250	350~450	
	tan δ(Max)	0.24	0.20	0.17	0.15	0.12	0.10	0.09	0.08	0.15	0.20	
When nominal capacitance over 1000µF, tanδ shall be added 0.02 to the listed value with increase of every 1000µF .												
Low Temperature Stability 低溫特性 Impedance Ratio(Max) 阻抗比率(最大值)	Measurement Frequency: 120Hz.											
	Rated Voltage(V)	6.3	10	16	25	35	50	63	100	160~250	350~400	450
	Z(-25°C)/Z(20°C)	4	3	3	2	2	2	2	2	4	8	15
Z(-40°C)/Z(20°C)	8	6	6	4	4	4	4	4	6	-	-	
Load Life 負荷壽命	The following specifications shall be satisfied when the capacitors are restored to 20°C after subjected to DC voltage with the rated ripple current is applied for 5,000 hours (φ D≤8:3,000 hours; φ D=10:4,000 hours) at 105°C.											
	Capacitance Change	Within ± 20% of Initial Value										
	tan δ	200% or less of Initial Specified Value										
	Leakage Current	Initial Specified Value or less										
Shelf Life 放置壽命	The following specifications shall be satisfied when the capacitors are restored to 20°C after exposing them for 1,000 hours 105°C without voltage applied. Before the measurement, the capacitor shall be preconditioned by applying voltage according to them 4.1 of JIS C5101-4.											
	Capacitance Change	Within ± 20% of Initial Value										
	tan δ	200% or less of Initial Specified Value										
	Leakage Current	Initial Specified Value or less										
Standards 參照標準	JIS C 5101-4 (IEC 60384)											

Frequency Coefficient of Permissible Ripple Current

Rated Voltage (V)	Capacitance (µF)	Frequency (Hz)			
		50	120	1K	≥ 10K
≤ 100	< 100	0.70	1.00	1.40	1.60
	100 ~ 4700	0.75	1.00	1.30	1.40
	> 4700	0.80	1.00	1.15	1.20
≥ 160	2.2 ~ 820	0.80	1.00	1.30	1.40

The endurance of capacitors is reduced with internal heating produced by ripple current at the rate of halving the lifetime with every 5°C rise. When long life performance is required in actual use, the rms ripple current has to be reduced.

SE series

DIMENSIONS(mm)

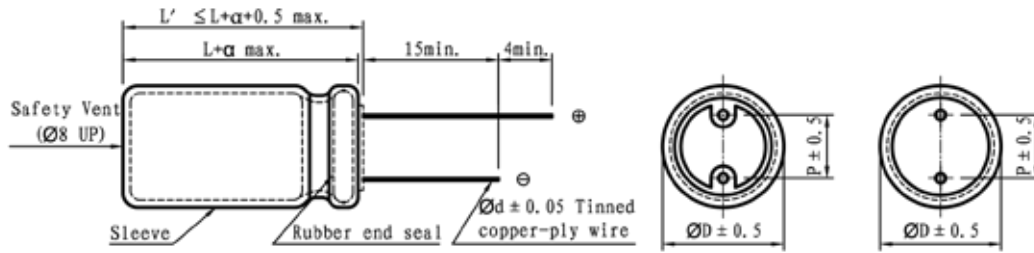

φ D	5	6.3	8	10	13	14.5	16	18	22	25
P	2.0	2.5	3.5	5.0	5.0	7.5	7.5	7.5	10	12.5
φ d	0.5	0.5	0.5	0.6	0.6	0.8	0.8	0.8	0.8	1.0

STANDARD RATINGS

D×L(mm) ; R.C.(mA rms) at 105°C 120Hz.

Cap (μF)	V	6.3		10		16		25		35		50		63	
		D x L	R.C.	D x L	R.C.	D x L	R.C.	D x L	R.C.	D x L	R.C.	D x L	R.C.	D x L	R.C.
0.47												5x11	8		
1												5x11	17		
2.2												5x11	23		
3.3												5x11	31		
4.7												5x11	35		
10								5x11	45	5x11	48	5x11	51	5x11	56
22								5x11	60	6.3x11	78	6.3x11	85	6.3x11	95
33								6.3x11	90	6.3x11	100	8x12	102	8x12	122
47						5x11	85	6.3x11	105	8x12	130	8x12	141	10x13	152
100		5x11	120	5x11	130	6.3x11	140	8x12	185	8x12	190	10x13	231	10x16	250
220		6.3x11	170	6.3x11	190	8x12	240	10x13	290	10x13	320	10x16	368	10x20	415
330		8x12	250	8x12	280	8x12	310	10x13	350	10x16	420	10x20	490	13x21	550
470		8x12	290	8x12	330	10x13	380	10x20	465	13x21	580	13x21	665	16x26	725
1000		10x13	490	10x16	580	10x20	670	13x21	830	13x25	1000	16x26	1080	16x32	1135
2200		10x20	830	13x21	970	13x25	1130	16x26	1210	16x32	1450	18x35	1695		
3300		13x21	1060	13x25	1250	16x26	1350	16x32	1540	18x35	1830	18x40	2070		
4700		13x25	1310	16x26	1400	16x32	1570	18x35	1870	18x40	2150				
6800		16x26	1430	16x32	1690	18x35	1930	18x40	2120						
10000		16x32	1790	18x35	2010	18x40	2190								
15000		18x35	1980	18x40	2260										
22000		18x40	2290												

Cap (μF)	V	100		160		200		250		350		400		450	
		D x L	R.C.	D x L	R.C.	D x L	R.C.	D x L	R.C.	D x L	R.C.	D x L	R.C.	D x L	R.C.
2.2		5x11	28	6.3x11	28	6.3x11	28	8x12	35	8x12	35	8x12	35	10x13	36
3.3		5x11	34	8x12	34	8x12	35	8x12	50	8x12	44	8x12	50	10x13	48
4.7		5x11	40	8x12	43	10x13	50	8x12	55	10x13	55	10x13	60	10x16	60
10		6.3x11	66	10x13	75	10x16	80	10x16	100	10x20	92	10x20	100	13x21	110
22		8x12	112	10x16	130	10x20	140	13x21	170	13x21	162	13x25	190	16x22	210
33		10x13	155	10x20	170	13x21	200	13x21	225	13x25	205	16x22	240	16x26	280
39		10x13	160	10x20	190	13x21	220	13x25	250	16x22	220	16x26	300	16x32	330
47		10x16	190	13x21	230	13x21	250	13x25	280	16x26	320	16x32	330	18x25	360
68		10x20	210	13x25	260	13x25	280	16x22	310	16x26	350	18x25	350	18x32	500
82		13x21	240	16x22	320	16x26	350	16x32	390	18x25	420	18x32	580	18x35	600
100		13x21	310	16x26	350	16x32	480	16x36	500	18x32	550	18x35	660	18x40	720
120										18x35	650	18x40	770		
220		16x26	540	18x35	640	18x40	810								
330		16x26	660												
470		16x32	880												
560				22x40	1300	22x50	1400								
680				22x50	1420	25x50	1550								
820						25x50	1700								

※ 13mm may be replaced by 12.5mm upon customer's request.

SE series

SLIM TYPE

- 105°C high-temperature and high voltage 350~450V, life 3000~5000hrs.
- Specially Size, 8~16mm diameter.
- For LCD-TV and LCD-Monitor power.
- RoHS Compliance.
- 105°C 耐高溫標準品，高壓350~450V，壽命3000~5000小時。
- 特殊專用尺寸，直徑8~16mm。
- 使用於LCD TV與LCD Monitor電源應用。



STANDARD RATINGS

D×L(mm) ; R.C.(mA rms) at 105°C 120Hz.

Cap (µF)	V	350		400		450	
		D x L	R.C.	D x L	R.C.	D x L	R.C.
22				8x50	135	10x40	280
33				8x61	280	10x50	350
		10x40	210	10x40	260	13x35	300
39		10x40	210	8x61	280	8x61	350
		13x30	270	10x45	300	10x50	350
				13x35	310	13x40	360
47		10x40	300	10x50	330	10x60	410
		13x35	320	13x40	350	13x50	370
		14.5x30	320	14.5x40	370	14.5x40	390
53		13x35	320	13x50	385	10x60	440
68		10x60	400	13x50	385	13x60	450
		13x40	420	14.5x45	400	14.5x50	400
		16x35	430	16x35	420	16x40	440
82		13x50	450	14.5x45	530	14.5x50	600
		16x35	500	16x40	550	16x45	620
100		16x40	530	14.5x50	700	16x50	760
				16x45	720		

※ 13mm may be replaced by 12.5mm upon customer's request.



SEA series

- On the basis of SE series ripple promotion product.
- Suitable for LCD TV Power, SMPS.
- RoHS Compliance.
- SE系列紋波提升品。
- 適用於液晶顯示電源及開關電源等。



SPECIFICATIONS

Items 項目	Characteristics 特性				
Capacitance Tolerance 靜電容量誤差	± 20%(120Hz,20°C)				
Operating Temperature Range 適用溫度範圍	-40 ~ +105°C		-25 ~ +105°C		
Rated Voltage Range 額定電壓範圍	400VDC		450 ~ 500VDC		
Leakage Current 洩漏電流	$I \leq 0.03CV + 20 (\mu A)$ (After 3 minutes application of DC rated voltage, at 20 °C)				
Dissipation Factor 散逸因素(tan δ)	Measurement Frequency: 120Hz. Temperature: 20°C				
	Rated Voltage(V)	160~400	450	460	500
	tan δ(Max)	0.15	0.20	0.20	0.20
	When nominal capacitance over 1000µF, tanδ shall be added 0.02 to the listed value with increase of every 1000µF .				
Low Temperature Stability 低溫特性 Impedance Ratio(Max) 阻抗比率(最大值)	Measurement Frequency: 120Hz.				
	Rated Voltage(V)	400	450	460	500
	Z(-25°C)/Z(20°C)	3	3	6	6
	Z(-40°C)/Z(20°C)	6	-	-	-
Load Life 負荷壽命	The following specifications shall be satisfied when the capacitors are restored to 20°C after subjected to DC voltage with the rated ripple current is applied for 5,000 hours at 105°C.				
	Capacitance Change	Within ± 20% of Initial Value			
	tan δ	200% or less of Initial Specified Value			
	Leakage Current	Initial Specified Value or less			
Shelf Life 放置壽命	The following specifications shall be satisfied when the capacitors are restored to 20°C after exposing them for 1,000 hours 105°C without voltage applied. Before the measurement. The capacitor shall be preconditioned by applying voltage according to them 4.1 of JIS C5101-4.				
	Capacitance Change	Within ± 20% of Initial Value			
	tan δ	200% or less of Initial Specified Value			
	Leakage Current	Initial Specified Value or less			
Standards 參照標準	JIS C 5101-4-1 (IEC 60384)				

Frequency Coefficient of Permissible Ripple Current

Capacitance (µF)	Frequency (Hz)				
	120	1K	10K	50K	100K
10 ~ 82	1.00	1.75	2.25	2.35	2.50
100 ~ 150	1.00	1.67	2.05	2.15	2.25

The endurance of capacitors is reduced with internal heating produced by ripple current at the rate of halving the lifetime with every 5°C rise. When long life performance is required in actual use . The rms ripple current has to be reduced.

SEA series

DIMENSIONS(mm)

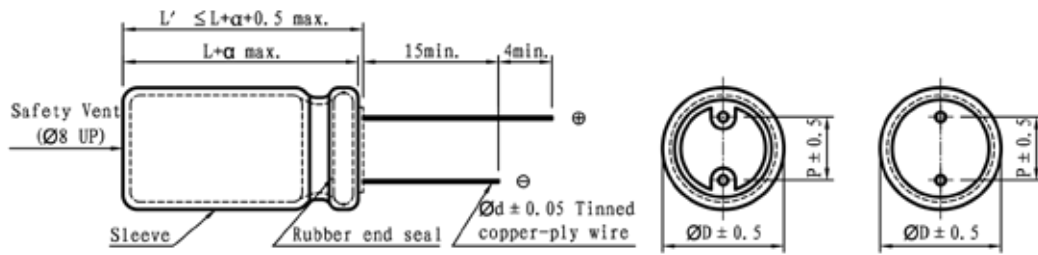

ϕD	10	13	16	18	20	22
P	5.0	5.0	7.5	7.5	10	10
ϕd	0.6	0.6	0.8	0.8	0.8	0.8

STANDARD RATINGS

D×L(mm) ; R.C.(mA rms) at 105°C 120Hz.

Cap (μF)	V	400				450				460				500			
		Item	D x L	R.C.		D x L	R.C.		D x L	R.C.		D x L	R.C.				
				120Hz	100KHz		120Hz	100KHz		120Hz	100KHz		120Hz	100KHz			
10		10x16	150	375	10x20	105	263	10x20	80	200	13x21	75	187.5				
15		10x20	170	425	13x21	130	325	13x21	110	275	13x21	90	225				
22		13x21	250	625	13x25	210	525	13x25	180	450	13x25	170	425				
33		13x25	350	875	16x22	270	675	16x25	330	825	16x25	260	650				
47		13x25	480	1200	18x26	450	1125	18x26	400	1000	18x32	350	875				
56		16x25	500	1250	18x26	550	1375	18x26	500	1250	18x35	520	1300				
68		18x26	650	1625	18x32	600	1500	18x32	600	1500	18x35	550	1375				
82		18x26	750	1875	18x32	650	1625	18x32	650	1625	18x40	650	1625				
100		18x32	800	1800	18x35	750	1688	18x35	750	1688	18x45	700	1575				
120		18x35	850	1913	18x40	800	1800	18x40	800	1800	22x45	800	1800				
150		18x40	900	2025	20x45	900	2025	20x45	900	2025							

※ 13mm may be replaced by 12.5mm upon customer's request.

SEA

SER series

- 105°C high-temperature resistance, high reliability and long life. high ripple current.
- Suitable for office communicative or industrial equipments.
- RoHS Compliance.
- 105°C耐高温、高信賴性、長壽命。
- 適用於辦公室通訊設備、工業設備。



SPECIFICATIONS

Items 項目	Characteristics 特性			
Capacitance Tolerance 靜電容量誤差	± 20%(120Hz,20°C)			
Operating Temperature Range 適用溫度範圍	-40 ~ +105°C		-25 ~ +105°C	
Rated Voltage Range 額定電壓範圍	160 ~ 400VDC		450VDC	
Leakage Current 洩漏電流	$I \leq 0.03CV + 20 (\mu A)$ (After 3 minutes application of DC rated voltage)			
Dissipation Factor 散逸因素(tan δ)	Measurement Frequency: 120Hz. Temperature: 20°C			
	Rated Voltage(V)	160 ~ 250	400 ~ 450	
	tan δ(Max)	0.15	0.20	
Low Temperature Stability 低溫特性 Impedance Ratio(Max) 阻抗比率(最大值)	Measurement Frequency: 120Hz.			
	Rated Voltage(V)	160 ~ 250	400	450
	Z(-25°C)/Z(20°C)	3	5	6
	Z(-40°C)/Z(20°C)	6	6	-
Load Life 負荷壽命	The following specifications shall be satisfied when the capacitors are restored to 20°C after subjected to DC voltage with the rated ripple current is applied for 5,000 hours at 105°C.			
	Capacitance Change	Within ± 25% of Initial Value		
	tan δ	200% of less of Initial Specified Value		
	Leakage Current	Initial Specified Value or less		
Shelf Life 放置壽命	The following specifications shall be satisfied when the capacitors are restored to 20°C after exposing them for 1,000 hours 105°C without voltage applied. Before the measurement, the capacitor shall be preconditioned by applying voltage according to them 4.1 of JIS C5101-4.			
	Capacitance Change	Within ± 20% of Initial Value		
	tan δ	200% of less of Initial Specified Value		
	Leakage Current	Initial Specified Value or less		
Standards 參照標準	JIS C 5101-4 (IEC 60384)			

Frequency Coefficient of Permissible Ripple Current

Capacitance (μF)	Frequency (Hz)			
	120	1K	10K	100K
22 ~ 82	1.00	1.25	1.50	1.75
100 ~ 470	1.00	1.15	1.30	1.40

The endurance of capacitors is reduced with internal heating produced by ripple current at the rate of halving the lifetime with every 5°C rise. When long life performance is required in actual use , the rms ripple current has to be reduced.

SER series

DIMENSIONS(mm)

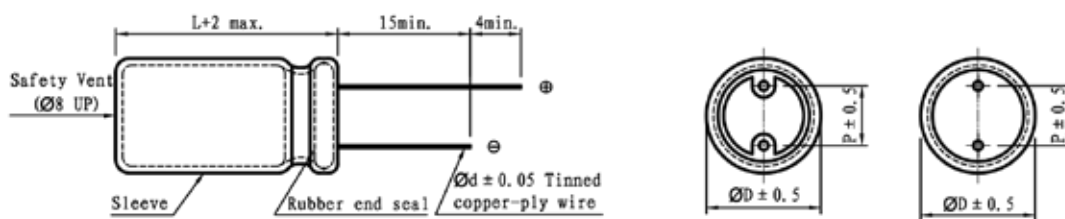

ϕD	10	13	14.5	16	18	20
P	5.0	5.0	7.5	7.5	7.5	10.0
ϕd	0.6	0.6	0.8	0.8	0.8	0.8

STANDARD RATINGS

D×L(mm) ; R.C.(mA rms) at 105°C 120Hz.

Cap (μF)	V	160		200		250		400		450		
		Item	D x L	R.C.	D x L	R.C.	D x L	R.C.	D x L	R.C.	D x L	R.C.
22			10x16	130					10x30	205	10x40	280
33			10x20	210					10x40	260	13x35	290
39			10x20	210					10x45	320	13x40	345
47			10x25	305				13x35	385	10x50	350	
										14.5x40	420	
56			10x25	305				13x40	420	14.5x40	420	
										16x30	477	
68			10x25	345	10x30	445	13x25	490	13x45	500	14.5x45	550
									14.5x30	500	18x32	550
82			10x30	445	10x35	485	13x30	550	14.5x40	545	16x40	650
											18x32	650
100			10x35	485	10x40	560	16x25	620	14.5x45	600	18x36	720
									18x32	600		
120			10x40	560	10x45	680	16x32	685	16x40	710	18x40	800
									18x36	710		
150			10x45	680	13x35	720	16x35	815	18x40	835	18x45	960
											20x40	1000
220			13x40	850	13x45	890	18x36	1020				
					14.5x35	890						
270			13x45	945	16x35	1030	18x40	1090				
330			16x35	1100	16x40	1200						
					18x32	1200						
470			18x40	1220	18x45	1305						

※ 13mm may be replaced by 12.5mm upon customer's request.

SER

HE series

- High ripple current.
- 8000~10000 hours long life product.
- RoHS Compliance
- 高紋波電流。
- 8000~10000小時長壽命品。

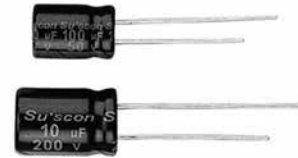

SPECIFICATIONS

Items 項目	Characteristics 特性						
Capacitance Tolerance 靜電容量誤差	± 20%(120Hz,20°C)						
Operating Temperature Range 適用溫度範圍	-40 ~ +105°C			-25 ~ +105°C			
Rated Voltage Range 額定電壓範圍	160 ~ 400VDC			450VDC			
Leakage Current 洩漏電流	$I \leq 0.04CV + 100 (\mu A)$ (After 1 minutes application of DC rated voltage, at 20 °C)						
Dissipation Factor 散逸因素(tan δ)	Measurement Frequency: 120Hz. Temperature: 20°C						
	Rated Voltage(V)	160	200	250	350	400	450
	tan δ(Max)	0.15	0.15	0.15	0.20	0.20	0.20
When nominal capacitance over 1000µF, tanδ shall be added 0.02 to the listed value with increase of every 1000µF.							
Low Temperature Stability 低溫特性	Measurement Frequency: 120Hz.						
	Rated Voltage(V)	160	200	250	350	400	450
	Z(-25°C)/Z(20°C)	3	3	3	6	6	6
Impedance Ratio(Max) 阻抗比率(最大值)	Z(-40°C)/Z(20°C)	6	6	6	6	6	-
	The following specifications shall be satisfied when the capacitors are restored to 20°C after subjected to DC voltage with the rated ripple current is applied for 10,000 hours(φ D=10:8,000 hours) at 105°C.						
Load Life 負荷壽命	Capacitance Change	Within ± 20% of Initial Value					
	tan δ	200% or less of Initial Specified Value					
	Leakage Current	Initial Specified Value or less					
Shelf Life 放置壽命	The following specifications shall be satisfied when the capacitors are restored to 20°C after exposing them for 1,000 hours 105°C without voltage applied. Before the measurement, the capacitor shall be preconditioned by applying voltage according to them 4.1 of JIS C5101-4.						
	Capacitance Change	Within ± 20% of Initial Value					
	tan δ	200% or less of Initial Specified Value					
Leakage Current	Initial Specified Value or less						
Standards 參照標準	JIS C 5101-4 (IEC 60384)						

Frequency Coefficient of Permissible Ripple Current

Capacitance (µF)	Frequency (Hz)				
	50	120	1K	10K	100K
6.8 ~ 82	0.70	1.00	1.75	2.25	2.50
100 ~ 330	0.75	1.00	1.67	2.05	2.25

The endurance of capacitors is reduced with internal heating produced by ripple current at the rate of halving the lifetime with every 5°C rise. When long life performance is required in actual use , the rms ripple current has to be reduced.

HE series

DIMENSIONS(mm)

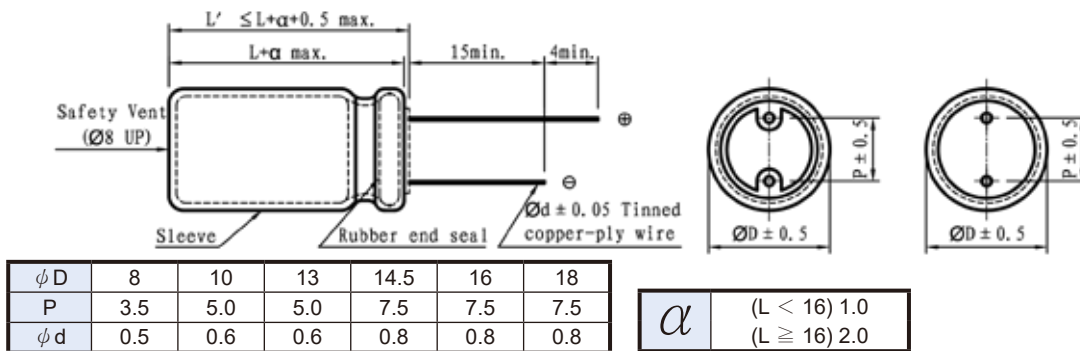

STANDARD RATINGS

D×L(mm) ; R.C.(mA rms) at 105°C 120Hz.

Cap (μF)	V	160				200				250			
		Item	D x L	R.C.		D x L	R.C.		D x L	R.C.			
				120Hz	100KHZ		120Hz	100KHZ		120Hz	100KHZ		
10		10x16	125	313	10x16	125	313	10x20	140	350			
22		10x20	200	500	10x20	200	500	10x20	200	500			
33		10x20	250	625	10x20	260	650	13x21	320	800			
47		10x20	300	750	13x21	390	975	13x21	390	975			
68		13x21	470	1175	13x21	470	1175	16x22	520	1300			
82		13x21	510	1275	16x22	550	1375	16x22	550	1375			
100		13x25	620	1395	16x22	630	1418	16x26	680	1530			
		16x22	630	1418									
150		16x22	770	1733	16x26	840	1890	18x25	860	1935			
220		18x25	1020	2295	18x26	1050	2363	18x32	1130	2543			
330		18x32	1390	3128	18x36	1430	3218						

Cap (μF)	V	350				400				450			
		Item	D x L	R.C.		D x L	R.C.		D x L	R.C.			
				120Hz	100KHZ		120Hz	100KHZ		120Hz	100KHZ		
6.8		10x16	110	275	10x16	110	275	10x20	110	275			
10		10x20	140	350	10x20	140	350	13x21	180	450			
22		13x21	260	650	13x21	260	650	16x22	290	725			
33		16x22	360	900	16x22	360	900	16x26	390	975			
								18x22	380	950			
47		16x22	430	1075	16x25	470	1175	18x25	480	1200			
					18x22	450	1125						
68		16x26	560	1400	18x25	585	1463	18x32	630	1575			
		18x22	550	1375									
82		18x25	610	1525	18x25	610	1525	18x35	715	1788			
100		18x25	700	1575	18x32	765	1721	18x40	800	1800			
120		18x32	830	1868	18x35	865	1946						
150		18x35	960	2160	18x40	985	2216						

※ 13mm may be replaced by 12.5mm upon customer's request.

HE

HE series

SLIM TYPE

- 105°C high-temperature and high voltage 350~450V, life 8000~10000hrs.
- Specially Size, 8~16mm diameter.
- For LCD-TV and LCD-Monitor power.
- RoHS Compliance.
- 105°C 耐高溫，高壓350~450V，壽命8000~10000小時。
- 特殊專用尺寸，直徑8~16mm。
- 使用於LCD TV與LCD Monitor電源應用。



STANDARD RATINGS

D×L(mm) ; R.C.(mA rms) at 105°C 120Hz.

Cap (μF)	V	350			400			450					
		Item	D x L	R.C.		D x L	R.C.		D x L	R.C.			
				120Hz	100KHZ		120Hz	100KHZ		120Hz	100KHZ		
22	10x30	10x30	212	530	8x50	236	590	8x50	254	635			
					10x35	260	650	10x40	280	700			
33	8x50	8x50	240	600	8x61	280	700	8x61	280	700			
					10x35	260	650	10x40	312	780	10x45	332	830
39	10x40	10x40	280	700	13x30	336	840	13x40	360	900			
					10x50	380	950	10x50	420	1050			
47	13x35	13x35	400	1000	13x35	368	920	13x45	408	1020			
					10x50	380	950	10x60	520	1300			
53	14.5x30	14.5x30	400	1000	13x40	460	1150	13x50	560	1400			
					14.5x30	400	1000	14.5x35	440	1100	14.5x45	512	1280
					10x50	440	1100	10x60	480	1200	13x50	600	1500
68	13x45	13x45	480	1200	13x45	500	1250	14.5x45	512	1280			
					14.5x30	400	1000	14.5x35	440	1100	16x35	560	1400
					10x60	520	1300	13x50	540	1350	13x60	660	1650
82	14.5x40	14.5x40	540	1350	14.5x45	600	1500	14.5x50	680	1700			
					13x50	540	1350	13x60	600	1500	13x60	700	1750
					14.5x50	648	1620	14.5x50	648	1620	14.5x50	720	1800
100	16x40	16x40	648	1620	16x40	648	1620	16x45	792	1980			
					13x60	660	1485	14.5x50	770	1733	14.5x60	855	1924
		14.5x45	682	1534	16x50	902	2030	16x50	990	2228			

※ 13mm may be replaced by 12.5mm upon customer's request.

HE

HU series

- 105°C 10000 hours, miniaturized and long life.
- RoHS Compliance
- 105°C 10000小時小型化長壽命品。

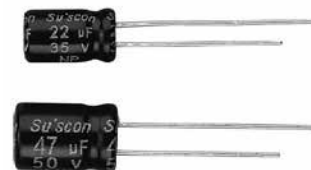

SPECIFICATIONS

Items 項目	Characteristics 特性							
Capacitance Tolerance 靜電容量誤差	± 20%(120Hz, 20°C)							
Operating Temperature Range 適用溫度範圍	- 25 ~ +105°C							
Rated Voltage Range 額定電壓範圍	10 ~ 100VDC							
Leakage Current 洩漏電流	I ≤ 0.01CV or 3(μA) which is greater.(After 2 minutes application of DC rated voltage, at 20°C)							
Dissipation Factor 散逸因素(tan δ)	Measurement Frequency:120Hz. Temperature: 20°C							
	Rated Voltage(V)	10	16	25	35	50	63	100
	tanδ(MAX)	0.45	0.35	0.3	0.22	0.19	0.17	0.15
Low Temperature Stability 低溫特性 Impedance Ratio(Max) 阻抗比率(最大值)	Measurement Frequency:120Hz							
	Rated Voltage(V)	10	16	25	35	50	63	100
	Z(-25°C) / Z(20°C)	8	6	4	4	3	3	3
Load Life 負荷壽命	The following specifications shall be satisfied when the capacitors are restored to 20°C after subjected to DC voltage with the rated ripple current is applied for 10,000 hours at 105°C.							
	Capacitance Change	within ±25% of Initial Value						
	tan δ	300% or less of Initial Specified Value						
	Leakage Current	Initial Specified Value or less						
Shelf Life 放置壽命	The following specifications shall be satisfied when the capacitors are restored to 20°C after exposing them for 1,000hours 105°C without voltage applied. Before the measurement. The Capacitance shall be preconditioned by applying voltage according to them 4.1 of JIS C5101-4.							
	Capacitance Change	within ±25% of Initial Value						
	tan δ	300% or less of Initial Specified Value						
	Leakage Current	Initial Specified Value or less						
Standards 參照標準	JIS C 5101-4-1 (IEC 60384)							

Frequency Coefficient of Permissible Ripple Current

Rated Voltage (V)	Capacitance (μF)	Frequency (Hz)			
		120	1K	10K	100K
10~100	0.47~10	0.42	0.60	0.80	1.00
	22~33	0.55	0.75	0.90	1.00
	47~330	0.70	0.85	0.95	1.00

The endurance of capacitors is reduced with internal heating produced by ripple current at the rate of halving the lifetime with every 5°C rise.when long life performance is required in actual use. The rms ripple current has to be reduced.

HU

HU series

DIMENSIONS(mm)

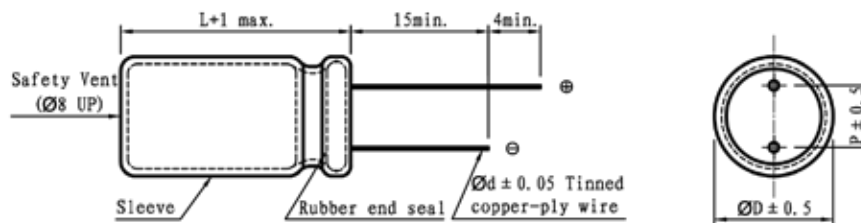

ϕD	5	6.3	8
P	2.0	2.5	3.5
ϕd	0.5	0.5	0.5

STANDARD RATINGS

D×L(mm) ; R.C.(mA rms) at 105°C 100KHz.

Cap (μF)	V Item	10		16		25		35		50		63		100	
		D x L	R.C.	D x L	R.C.	D x L	R.C.	D x L	R.C.	D x L	R.C.	D x L	R.C.	D x L	R.C.
0.47										5x12	12			5x12	20
1										5x12	25			5x12	40
2.2										5x12	35			5x12	50
3.3										5x12	70			5x12	60
4.7										5x12	80			5x12	70
10										5x12	90	5x12	80	6.3x12	150
22										5x12	120	6.3x12	170	8x12	230
33						5x12	124	5x12	130	6.3x12	190	6.3x12	170		
47				5x12	130	5x12	157	6.3x12	210	6.3x12	190	8x12	240		
100		5x12	130	6.3x12	210	6.3x12	210	8x12	330	8x12	270				
220		6.3x12	210	8x12	330										
330		8x12	330												

HU

HH series

- Miniature HE series, long-life products.
- Load life : 10000~12000hours.
- Suitable for electronic ballast for lighting equipment.
- long-life power input with smooth function.
- RoHS Compliance
- HE系列的小型化長壽命品。
- 保證壽命10000~12000hours.
- 適用於照明設備電子整流器，長壽命電源輸入平滑用等。

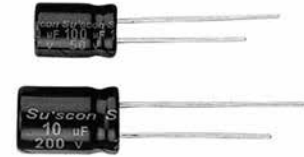

SPECIFICATIONS

Items 項目	Characteristics 特性						
Capacitance Tolerance 靜電容量誤差	± 20%(120Hz, 20°C)						
Operating Temperature Range 適用溫度範圍	- 40 ~ +105°C			- 25 ~ +105°C			
Rated Voltage Range 額定電壓範圍	160 ~ 400VDC			420~450VDC			
Leakage Current 洩漏電流	I ≤ 0.04CV+100µA.(After 1minutes application of DC rated voltage, at 20 °C)						
Dissipation Factor 散逸因素(tan δ)	Measurement Frequency:120Hz. Temperature: 20°C						
	Rated Voltage(V)	160	200~220	250	350	400~420	450
	tanδ(MAX)	0.20	0.20	0.20	0.24	0.24	0.24
When nominal capacitance over 1000µF, tanδ shall be added 0.02 to the listed value with increase of every 1000µF							
Low Temperature Stability 低溫特性 Impedance Ratio(Max) 阻抗比率(最大值)	Measurement Frequency:120Hz						
	Rated Voltage(V)	160	200	250	350	400	450
	Z(-25°C) / Z(20°C)	3	3	3	5	5	6
Z(-40°C) / Z(20°C)							
8							
8							
10							
10							
-							
Load Life 負荷壽命	The following specifications shall be satisfied when the capacitors are restored to 20°C after subjected to DC voltage with the rated ripple current is applied for 12,000 hours at 105°C.(L≤20mm,10,000 hours)						
	Capacitance Change	within ±20% of Initial Value					
	tan δ	200% or less of Initial Specified Value					
	Leakage Current	Initial Specified Value or less					
Shelf Life 放置壽命	The following specifications shall be satisfied when the capacitors are restored to 20°C after exposing them for 1,000hours 105°C without voltage applied. Before the measurement. The Capacitance shall be preconditioned by applying voltage according to them 4.1 of JIS C5101-4.						
	Capacitance Change	within ±20% of Initial Value					
	tan δ	200% or less of Initial Specified Value					
	Leakage Current	Initial Specified Value or less					
Standards 參照標準	JIS C 5101-4 (IEC 60384)						

Frequency Coefficient of Permissible Ripple Current

Capacitance (µF)	Frequency (Hz)			
	120	1K	10K	100K
6.8~82	1.00	1.75	2.25	2.50
100~680	1.00	1.67	2.05	2.25

The endurance of capacitors is reduced with internal heating produced by ripple current at the rate of halving the lifetime with every 5°C rise.when long life performance is required in actual use. The rms ripple current has to be reduced.



HH series

DIMENSIONS(mm)

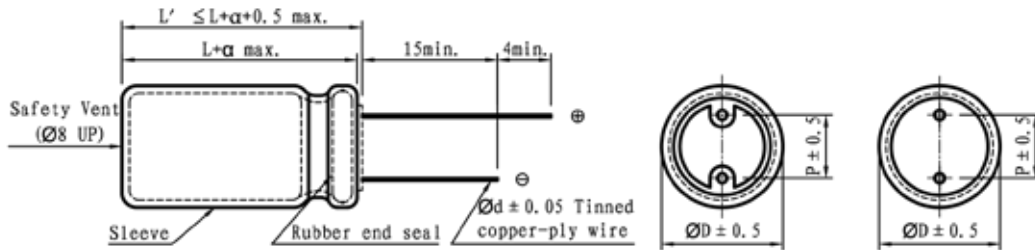

ϕD	10	13	16	18
P	5.0	5.0	7.5	7.5
ϕd	0.6	0.6	0.8	0.8

STANDARD RATINGS

D×L(mm) ; R.C.(mA rms) at 105°C 120Hz.

Cap (μF)	V	160		200		250		350		400		450	
		Item	D x L	R.C.	D x L	R.C.	D x L	R.C.	D x L	R.C.	D x L	R.C.	D x L
6.8										10x16	130	10x16	100
10										10x16	140	10x20	130
12								10x16	150	10x20	165	10x20	145
15								10x20	170	10x20	180	10x25	175
22				10x16	210	10x16	210	10x20	215	10x30	260	13x25	285
33	10x16	230	10x20	290	10x20	290	13x21	330	13x25	365	16x22	365	
47	10x20	285	10x20	340	13x21	465	13x25	485	16x22	495	16x26	475	
56	10x20	300	10x25	395	13x21	490	16x22	530	16x26	555	18x26	530	
68	13x21	500	13x21	520	13x25	550	16x26	630	16x26	600	16x36	625	
82	13x21	580	13x25	610	16x22	655	18x26	720	18x26	720	18x32	695	
100	13x21	610	16x22	655	16x22	680	18x26	750	18x32	830	18x35	790	
120	16x22	720	16x25	760	16x26	800	18x32	890	18x35	890	18x40	885	
150	16x22	780	18x22	865	18x26	920	18x35	1020	18x40	980			
180	16x25	950	18x26	950	18x30	990	18x40	1140	18x45	1050			
220	18x25	1050	18x30	1125	18x32	1100	18x45	1235					
270	18x30	1170	18x35	1340	18x40	1380							
330	18x35	1370	18x40	1480	18x45	1450							
390	18x36	1500	18x45	1590									
470	18x40	1825	18x50	1760									
560	18x45	2025											
680	18x50	2185											

※13mm may be replaced by 12.5mm upon customer's request.

HH

SH series

- High temperature resistance, high reliability.
- 125°C, 2000 hours long life product.
- RoHS Compliance
- 耐高溫、高信賴性。
- 125°C 2000小時長壽命品。



SPECIFICATIONS

Items 項目	Characteristics 特性												
Capacitance Tolerance 靜電容量誤差	± 20%(120Hz,20°C)												
Operating Temperature Range 適用溫度範圍	-40 ~ +125°C				-40 ~ +125°C				-25 ~ +125°C				
Rated Voltage Range 額定電壓範圍	10 ~ 100VDC				160 ~ 250VDC				350 ~ 450VDC				
Leakage Current 洩漏電流	I ≤ 0.01CV or 3 (µA) which is greater. (After 2 minutes application of DC rated voltage, at 20 °C)							I ≤ 0.03CV + 20 (µA) (After 3 minutes application of DC rated voltage, at 20 °C)					
Dissipation Factor 散逸因素(tan δ)	Measurement Frequency: 120Hz. Temperature: 20°C												
	Rated Voltage(V)	10	16	25	35	50	63	100	160	200	250	350~450	
	tan δ(Max)	0.20	0.16	0.14	0.12	0.10	0.10	0.10	0.15	0.20	0.20	0.24	
	When nominal capacitance over 1000µF, tanδ shall be added 0.02 to the listed value with increase of every 1000µF.												
Low Temperature Stability 低溫特性 Impedance Ratio(Max) 阻抗比率(最大值)	Measurement Frequency: 120Hz.												
	Rated Voltage(V)	10	16	25	35	50	63	100	160	200	250	350~450	
	Z(-25°C)/Z(20°C)	3	2	2	2	2	2	3	3	3	3	6	
	Z(-40°C)/Z(20°C)	8	6	4	4	4	4	4	6	6	6	-	
Load Life 負荷壽命	The following specifications shall be satisfied when the capacitors are restored to 20°C after subjected to DC voltage with the rated ripple current is applied for 2,000 hours at 125°C.												
	Capacitance Change	Within ± 25% of Initial Value											
	tan δ	200% or less of Initial Specified Value											
	Leakage Current	Initial Specified Value or less											
Shelf Life 放置壽命	The following specifications shall be satisfied when the capacitors are restored to 20°C after exposing them for 1,000 hours 125°C without voltage applied. Before the measurement, the capacitor shall be preconditioned by applying voltage according to them 4.1 of JIS C5101-4.												
	Capacitance Change	Within ± 25% of Initial Value											
	tan δ	200% or less of Initial Specified Value											
	Leakage Current	Initial Specified Value or less											
Standards 參照標準	JIS C 5101-4 (IEC 60384)												

SH

Frequency Coefficient of Permissible Ripple Current

Rated Voltage (V)	Capacitance (µF)	Frequency (Hz)			
		50	120	1K	≥ 10K
≤ 100	< 100	0.75	1.00	1.57	2.00
	100 ~ 470	0.80	1.00	1.34	1.50
	> 470	0.85	1.00	1.10	1.15
≥ 160	1 ~ 100	0.85	1.00	1.40	1.50

The endurance of capacitors is reduced with internal heating produced by ripple current at the rate of halving the lifetime with every 5°C rise. When long life performance is required in actual use , the rms ripple current has to be reduced.

SH series

DIMENSIONS(mm)

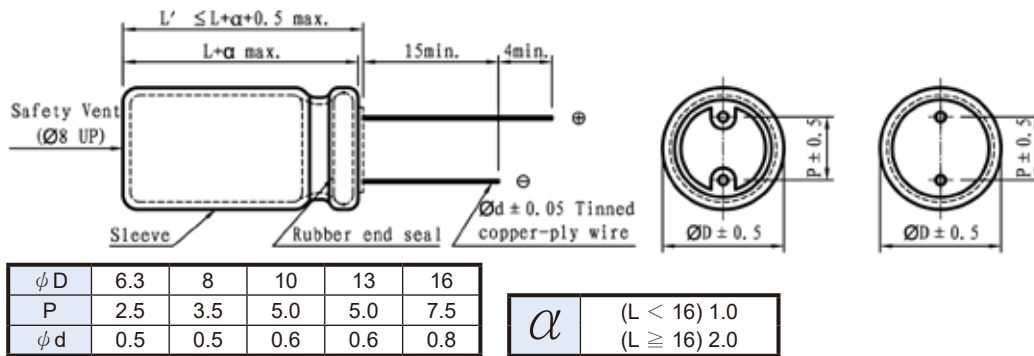

STANDARD RATINGS

D×L(mm) ; R.C.(mA rms) at 125°C 120Hz.

Cap (μF)	V	10		16		25		35		50		63	
		Item	D x L	R.C.	D x L	R.C.	D x L	R.C.	D x L	R.C.	D x L	R.C.	D x L
3.3												8x12	28
4.7												8x12	35
10								6.3x11	40	8x12	45	8x12	54
22						6.3x11	70	8x12	78	8x12	80	10x13	92
33				6.3x11	70	8x12	90	8x12	105	8x12	112	10x16	130
47	6.3x11	80	6.3x11	82	8x12	110	8x12	148	10x13	154	10x20	170	
100	6.3x11	105	8x12	146	8x12	220	10x13	252	10x16	267	13x21	285	
220	8x12	230	10x13	300	10x13	450	10x16	530	13x21	568	13x25	585	
330	10x13	310	10x13	385	10x16	620	10x20	710	13x25	880	16x26	950	
470	10x13	420	10x16	520	10x20	800	13x21	890	16x26	900			
1000	10x20	760	13x21	800	13x25	900	16x26	1100					

Cap (μF)	V	100		160		200		250		350		400		450	
		Item	D x L	R.C.	D x L	R.C.	D x L	R.C.	D x L	R.C.	D x L	R.C.	D x L	R.C.	
0.47		8x12	15												
1		8x12	22	8x12	28	8x12	28	8x12	40	8x12	40	8x12	42	8x12	45
2.2		8x12	30	8x12	35	8x12	35	10x13	48	10x13	48	10x13	48	10x16	52
3.3		8x12	35	10x13	40	10x16	45	10x16	50	10x16	50	10x16	53	10x20	58
4.7		10x13	42	10x13	50	10x16	60	10x20	65	10x20	53	10x20	62	10x25	65
10		10x16	68	10x16	80	10x20	78	10x20	78	10x25	85	10x25	86	13x21	90
22		10x20	95	10x20	115	10x25	126	13x21	128	13x25	139	13x30	142	16x26	154
33		13x21	150	10x25	154	13x21	157	13x25	171	16x26	189	16x26	189	16x32	203
47		13x25	180	13x25	200	13x25	204	16x26	292	16x32	243	16x32	243		
68		13x25	210	16x26	245	16x26	250	16x32	292						
100		16x26	290	16x32	360	16x36	329								

※ 13mm may be replaced by 12.5mm upon customer's request.

SH

UH series

- High temperature, high ripple current at high frequency.
- Specially designed for electronic ballast and energy saving lamp.
- Load Life : 2,000~3,000 hours.
- RoHS Compliance
- 耐高溫、高紋波及高頻率。
- 專為電子整流器和節能燈。
- 2,000~3,000小時長壽命品。



SPECIFICATIONS

Items 項目	Characteristics 特性												
Capacitance Tolerance 靜電容量誤差	± 20%(120Hz,20°C)												
Operating Temperature Range 適用溫度範圍	- 40 ~ +130°C						- 40 ~ +130°C			- 25 ~ +130°C			
Rated Voltage Range 額定電壓範圍	10 ~ 100VDC						160 ~ 250VDC			350 ~ 450VDC			
Leakage Current 洩漏電流	I ≤ 0.01CV or 3 (µA) which is greater.(After 2 minutes application of DC rated voltage, at 20 °C)						I ≤ 0.03CV +20 (µA) (After 3 minutes application of DC rated voltage, at 20 °C)						
Leakage Current 散逸因素(tan δ)	Measurement Frequency:120Hz. Temperature: 20°C												
	Rated Voltage(V)	10	16	25	35	50	63	100	160	200	250	350 ~ 450	
	tanδ (Max)	0.20	0.16	0.14	0.12	0.10	0.10	0.10	0.15	0.20	0.20	0.24	
When nominal capacitance over 1000µF, tanδ shall be added 0.02 to the listed value with increase of every 1000µF .													
Low Temperature Stability 低溫特性	Measurement Frequency:120Hz												
	Rated Voltage(V)	10	16	25	35	50	63	100	160	200	250	350 ~ 450	
	Impedance Ratio(Max) 阻抗比率(最大值)	Z(-25°C) / Z(20°C)	3	2	2	2	2	2	3	3	3	3	6
	Z(-40°C) / Z(20°C)	8	6	4	4	4	4	4	6	6	6	-	
Load Life 負荷壽命	The following specifications shall be satisfied when the capacitors are restored to 20°C after subjected to DC voltage with the rated ripple current is applied for 3,000 hours(ϕ D≤8:2,000 hours) at 130°C.												
	Capacitance Change	within ±25% of Initial Value											
	tan δ	200% or less of Initial Specified Value											
	Leakage Current	Initial Specified Value or less											
Shelf Life 放置壽命	The following specifications shall be satisfied when the capacitors are restored to 20°C after exposing them for 1,000hours 130°C without voltage applied. Before the measurement. The Capacitance shall be preconditioned by applying voltage according to them 4.1 of JIS C5101-4.												
	Capacitance Change	within ±25% of Initial Value											
	tan δ	200% or less of Initial Specified Value											
	Leakage Current	Initial Specified Value or less											
Standards 參照標準	JIS C 5101-4 (IEC 60384)												

UH

Frequency Coefficient of Permissible Ripple Current

Rated Voltage (V)	Capacitance (µF)	Frequency (Hz)			
		50	120	1K	≥10K
≤ 100	< 100	0.50	0.70	0.85	1.00
	100 ~ 1500	0.65	0.75	0.90	1.00
	> 1500	0.75	0.80	0.95	1.00
≥ 160	1.8~5.6	0.20	0.40	0.80	1.00
	6.8~100	0.40	0.75	0.90	1.00

The endurance of capacitors is reduced with internal heating produced by ripple current at the rate of halving the lifetime with every 5°C rise. When long life performance is required in actual use. The rms ripple current has to be reduced.

UH series

DIMENSIONS(mm)

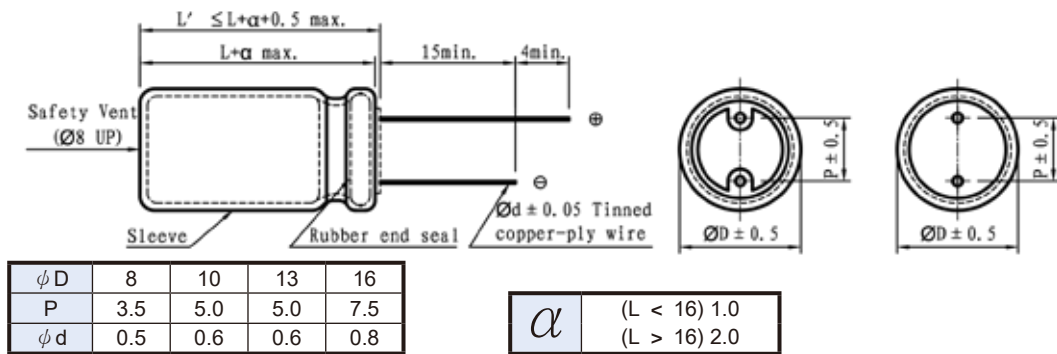

STANDARD RATINGS

D×L (mm); R.C.: (mA rms) at 130°C, 100KHz.

Cap (µF)	V	10		16		25		35		50		63	
		Item	D x L	R.C.	D x L	R.C.	D x L	R.C.	D x L	R.C.	D x L	R.C.	D x L
3.3										8x12	70		
4.7										8x12	100		
10										8x12	200	8x12	200
22										8x12	260	8x12	250
33										8x12	300	10x13	400
47										8x12	300	10x16	450
100		8x12	340	8x12	340	8x12	340	10x13	620	10x13	520	13x21	820
220		8x12	340	10x13	620	10x13	620	10x16	800	10x20	890	13x25	1000
330		10x13	580	10x13	620	10x16	800	10x20	960	13x21	1000	16x26	1500
470		10x13	620	10x16	800	10x20	960	13x21	1430	13x25	1200	16x32	1850
1000		10x20	960	13x21	1430	13x25	1430	16x26	1900	16x32	2180		
2200		13x25	1430	16x26	1900	16x32	2300	16x36	2550				
3300		16x26	1900	16x32	2300	16x36	2550						
4700		16x32	2300	16x36	2550								

Cap (µF)	V	100		160		200		250		350		400		450	
		Item	D x L	R.C.	D x L	R.C.	D x L	R.C.	D x L	R.C.	D x L	R.C.	D x L	R.C.	D x L
1.8										10x16	62	10x16	60	10x16	58
2.2										10x16	70	10x16	68	10x16	66
3.3										10x16	84	10x16	82	10x16	80
4.7		8x12	80	8x12	80	8x12	80	10x16	70	10x20	105	10x20	100	10x20	90
5.6		8x12	118	8x12	100	8x16	118	10x16	130	10x20	150	13x21	160	13x21	150
6.8		8x12	145	8x14	130	8x16	145	10x16	150	13x21	186	13x21	186	13x21	176
10		8x12	200	10x16	200	10x16	200	10x20	224	13x21	278	13x21	278	16x26	510
22		8x12	220	10x20	300	13x21	400	13x21	400	13x25	430	13x25	430	16x32	630
33		10x13	260	13x21	400	13x21	480	13x25	510	16x26	600	16x26	600		
47		10x16	330	13x25	528	13x25	528	16x26	620	16x32	650	16x32	650		
100		13x21	670	16x26	716										
220		16x26	1100												
330		16x32	1300												

※ 13mm may be replaced by 12.5mm upon customer's request.

UH

HA series

- 105°C high-temperature resistance, standard product.
- 3000 hours Load Life.
- Suitable for LED and electronic rectifier.
- RoHS Compliance
- 105°C耐高溫標準品。
- 壽命3000小時。
- 適用於節能燈與電子整流器。

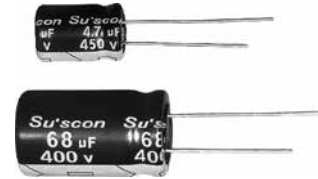

SPECIFICATIONS

Items 項目	Characteristics 特性						
Capacitance Tolerance 靜電容量誤差	± 20%(120Hz,20°C)						
Operating Temperature Range 適用溫度範圍	-40 ~ +105°C			-25 ~ +105°C			
Rated Voltage Range 額定電壓範圍	160 ~ 400VDC			450VDC			
Leakage Current 洩漏電流	I ≤ 0.02CV + 10 (µA) (After 2 minutes application of DC rated voltage, at 20 °C)			I ≤ 0.03CV + 10 (µA) (After 2 minutes application of DC rated voltage, at 20 °C)			
Dissipation Factor 散逸因素(tan δ)	Measurement Frequency: 120Hz. Temperature: 20°C						
	Rated Voltage(V)	160~180	200	250	350	400	450
	tan δ(Max)	0.15	0.15	0.15	0.15	0.20	0.20
Low Temperature Stability 低溫特性 Impedance Ratio(Max) 阻抗比率(最大值)	Measurement Frequency: 120Hz.						
	Rated Voltage(V)	160	200	250	350	400	450
	Z(-25°C)/Z(20°C)	3	3	3	5	5	6
	Z(-40°C)/Z(20°C)	6	6	6	6	6	-
Load Life 負荷壽命	The following specifications shall be satisfied when the capacitors are restored to 20°C after subjected to DC voltage with the rated ripple current is applied for 3,000 hours at 105°C.						
	Capacitance Change	Within ± 20% of Initial Value					
	tan δ	200% or less of Initial Specified Value					
	Leakage Current	Initial Specified Value or less					
Shelf Life 放置壽命	The following specifications shall be satisfied when the capacitors are restored to 20°C after exposing them for 1,000 hours 105°C without voltage applied. Before the measurement, the capacitor shall be preconditioned by applying voltage according to them 4.1 of JIS C5101-4.						
	Capacitance Change	Within ± 20% of Initial Value					
	tan δ	200% or less of Initial Specified Value					
	Leakage Current	500% or less of Initial Specified Value					
Standards 參照標準	JIS C 5101-4 (IEC 60384)						

Frequency Coefficient of Permissible Ripple Current

Rated Voltage (V)	Frequency (Hz)			
	120	1K	10K ~ 20K	30K ~ 100K
160 ~ 250	0.55	0.85	0.90	1.00
350 ~ 450	0.50	0.80	0.90	1.00

The endurance of capacitors is reduced with internal heating produced by ripple current at the rate of halving the lifetime with every 5°C rise. When long life performance is required in actual use , the rms ripple current has to be reduced.

HA

HA series

DIMENSIONS(mm)

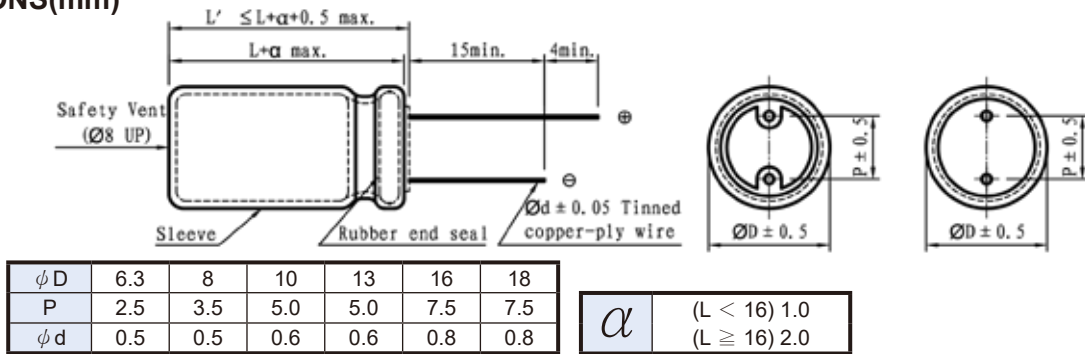

STANDARD RATINGS

D×L(mm) ; R.C.(mA rms) at 105°C 100KHz.

Cap (μF)	V	160		200		250	
		D x L	R.C.	D x L	R.C.	D x L	R.C.
2.2		6.3x11	36	6.3x11	38	8x12	47
3.3		8x12	50	8x12	59	8x12	69
4.7		8x12	55	8x12	65	8x12	70
5.6		8x12	65	8x12	75	8x16	85
6.8		8x12	70	8x14	80	10x13	95
8.2		8x12	80	8x16	85	10x16	105
10		8x12	85	10x13	120	10x16	150
15		8x16	120	10x13	150	10x16	180
22		10x16	195	10x16	210	10x20	250
33		10x20	230	13x21	280	13x21	320
47		13x21	310	13x21	395	13x25	410
68		13x21	380	13x25	460	16x26	480
82		13x25	430	13x25	570	16x26	590
100		16x26	640	16x26	670	16x32	720
150		16x26	700	16x32	790	18x32	875
220		16x36	990	18x35	1040	18x40	1100

Cap (μF)	V	350		400		450	
		D x L	R.C.	D x L	R.C.	D x L	R.C.
1		8x12	33	8x12	35	8x16	30
1.5		8x12	42	8x12	45	10x16	50
2.2		8x12	47	8x12	55	10x16	60
3.3		8x16	60	10x13	75	10x16	90
4.7		10x13	95	10x16	100	10x20	115
6.8		10x13	100	10x16	125	13x21	130
8.2		10x16	130	10x20	145	13x21	155
10		10x20	145	10x20	150	13x21	160
15		13x21	205	13x21	210	13x21	255
22		13x25	270	13x25	285	16x26	280
33		16x26	355	16x26	400	16x32	455
47		16x26	430	16x26	480	18x32	550
68		16x32	505	16x32	585	18x35	690
82		16x36	655	18x32	695	18x35	805
100		18x32	750	18x35	795	18x40	860

※ 13mm may be replaced by 12.5mm upon customer's request.

HA

HB series

- 105°C high-temperature resistance, high ripple current and long life.
- 5000hours load life.
- Suitable for LED and electronic rectifier.
- RoHS Compliance.
- 105°C耐高溫、高紋波、長壽命。
- 壽命為5000小時。
- 適用於節能燈與電子整流器。



SPECIFICATIONS

Items 項目	Characteristics 特性						
Capacitance Tolerance 靜電容量誤差	± 20%(120Hz,20°C)						
Operating Temperature Range 適用溫度範圍	-40 ~ +105°C			-25 ~ +105°C			
Rated Voltage Range 額定電壓範圍	160 ~ 400VDC			450VDC			
Leakage Current 洩漏電流	I ≤ 0.02CV + 10 (μA) (After 2 minutes application of DC rated voltage, at 20 °C)			I ≤ 0.03CV + 10 (μA) (After 2 minutes application of DC rated voltage, at 20 °C)			
Dissipation Factor 散逸因素(tan δ)	Measurement Frequency: 120Hz. Temperature: 20°C						
	Rated Voltage(V)	160	200	250	350	400	450~500
	tan δ(Max)	0.15	0.15	0.15	0.15	0.20	0.20
Low Temperature Stability 低溫特性 Impedance Ratio(Max) 阻抗比率(最大值)	Measurement Frequency: 120Hz.						
	Rated Voltage(V)	160	200	250	350	400	450
	Z(-25°C)/Z(20°C)	3	3	3	5	5	6
	Z(-40°C)/Z(20°C)	6	6	6	6	6	-
Load Life 負荷壽命	The following specifications shall be satisfied when the capacitors are restored to 20°C after subjected to DC voltage with the rated ripple current is applied for 5,000 hours at 105°C.						
	Capacitance Change	Within ± 20% of Initial Value					
	tan δ	200% or less of Initial Specified Value					
	Leakage Current	Initial Specified Value or less					
Shelf Life 放置壽命	The following specifications shall be satisfied when the capacitors are restored to 20°C after exposing them for 1,000 hours 105°C without voltage applied. Before the measurement, the capacitor shall be preconditioned by applying voltage according to them 4.1 of JIS C5101-4.						
	Capacitance Change	Within ± 20% of Initial Value					
	tan δ	200% or less of Initial Specified Value					
	Leakage Current	500% or less of Initial Specified Value					
Standards 參照標準	JIS C 5101-4 (IEC 60384)						

Frequency Coefficient of Permissible Ripple Current

Rated Voltage (V)	Frequency (Hz)			
	120	1K	10K ~ 20K	30K ~ 100K
160 ~ 250	0.55	0.85	0.90	1.00
350 ~ 450	0.50	0.80	0.90	1.00

The endurance of capacitors is reduced with internal heating produced by ripple current at the rate of halving the lifetime with every 5°C rise. When long life performance is required in actual use , the rms ripple current has to be reduced.

HB

HB series

DIMENSIONS(mm)

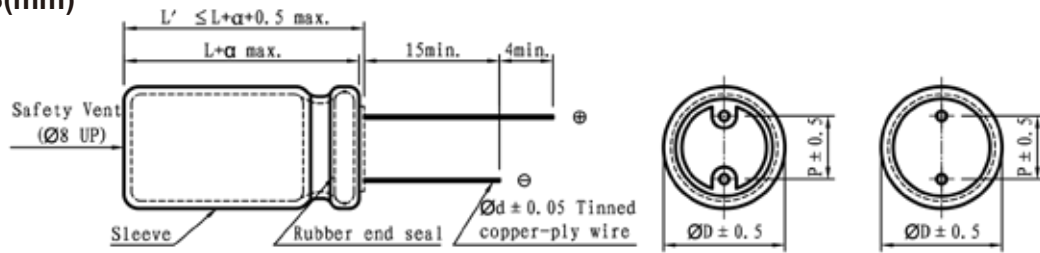

ϕD	6.3	8	10	13	16	18
P	2.5	3.5	5.0	5.0	7.5	7.5
ϕd	0.5	0.5	0.6	0.6	0.8	0.8

α	(L < 16) 1.0
	(L ≥ 16) 2.0

STANDARD RATINGS

D×L(mm) ; R.C.(mA rms) at 105°C 100KHz.

Cap (μF)	V	160		200		250		
		Item	D x L	R.C.	D x L	R.C.	D x L	R.C.
2.2			6.3x11	60	8x12	68	8x12	70
3.3			8x12	72	8x12	75	8x12	80
4.7			8x12	75	8x12	80	10x13	85
5.6			8x12	80	8x16	85	10x13	90
6.8			8x12	90	8x16	95	10x13	100
8.2			8x12	95	8x16	110	10x16	130
10			8x12	100	10x16	180	10x20	200
15			10x16	210	10x16	230	10x20	260
22			10x20	300	10x20	330	10x20	380
33			10x20	330	13x21	400	13x25	450
47			13x21	400	13x21	450	13x25	520
68			13x25	490	16x26	560	16x32	630
82			13x25	550	16x26	640	16x32	700
100			16x26	680	16x26	720	18x32	830
150			16x32	930	16x36	1030	18x35	1230
220			18x32	1050	18x35	1250	18x40	1340

Cap (μF)	V	350		400		450		
		Item	D x L	R.C.	D x L	R.C.	D x L	R.C.
1			8x12	43	8x16	50	8x16	60
1.5			8x12	45	10x13	53	10x16	63
2.2			8x12	53	10x13	63	10x16	70
3.3			10x13	80	10x16	90	10x16	95
4.7			10x16	90	10x16	100	10x20	105
5.6			10x16	100	10x16	108	10x20	110
6.8			10x20	130	10x20	155	13x21	160
8.2			13x21	160	13x21	190	13x21	220
10			13x21	190	13x21	230	13x21	250
15			13x25	230	13x25	250	13x25	300
22			16x26	300	16x26	380	16x32	430
33			16x26	350	16x32	430	16x36	560
47			16x36	480	18x26	580	18x32	630
68			18x26	560	18x32	650	18x35	780
82			18x32	730	18x35	800	18x40	950
100			18x35	840	18x40	930		

※ 13mm may be replaced by 12.5mm upon customer's request.

HB

HD series

- 105°C high-temperature resistance, high ripple current and long life.
- 10000hours load life.
- Suitable for LED and electronic rectifier.
- RoHS Compliance
- 105°C耐高溫、高紋波、長壽命。
- 壽命10000小時。
- 適用於節能燈與電子整流器。

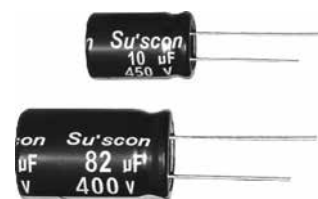

SPECIFICATIONS

Items 項目	Characteristics 特性						
Capacitance Tolerance 靜電容量誤差	± 20%(120Hz,20°C)						
Operating Temperature Range 適用溫度範圍	-40 ~ +105°C			-25 ~ +105°C			
Rated Voltage Range 額定電壓範圍	160 ~ 400VDC			450VDC			
Leakage Current 洩漏電流	I ≤ 0.02CV + 10 (µA) (After 2 minutes application of DC rated voltage, at 20 °C)			I ≤ 0.03CV + 10 (µA) (After 2 minutes application of DC rated voltage, at 20 °C)			
Dissipation Factor 散逸因素(tan δ)	Measurement Frequency: 120Hz. Temperature: 20°C						
	Rated Voltage(V)	160	200	250	350	400	450
	tan δ(Max)	0.15	0.15	0.15	0.15	0.20	0.20
Low Temperature Stability 低溫特性 Impedance Ratio(Max) 阻抗比率(最大值)	Measurement Frequency: 120Hz.						
	Rated Voltage(V)	160	200	250	350	400	450
	Z(-25°C)/Z(20°C)	3	3	3	5	5	6
	Z(-40°C)/Z(20°C)	6	6	6	6	6	-
Load Life 負荷壽命	The following specifications shall be satisfied when the capacitors are restored to 20°C after subjected to DC voltage with the rated ripple current is applied for 10,000 hours(8 φ ~10 φ :8,000 hours) at 105°C.						
	Capacitance Change	Within ± 20% of Initial Value					
	tan δ	200% or less of Initial Specified Value					
	Leakage Current	Initial Specified Value or less					
Shelf Life 放置壽命	The following specifications shall be satisfied when the capacitors are restored to 20°C after exposing them for 1,000 hours 105°C without voltage applied. Before the measurement, the capacitor shall be preconditioned by applying voltage according to them 4.1 of JIS C5101-4.						
	Capacitance Change	Within ± 20% of Initial Value					
	tan δ	200% or less of Initial Specified Value					
	Leakage Current	500% or less of Initial Specified Value					
Standards 參照標準	JIS C 5101-4 (IEC 60384)						

Frequency Coefficient of Permissible Ripple Current

Frequency (Hz)	50	120	1K	10K	100K
Coefficient	0.45	0.55	0.75	0.90	1.00

The endurance of capacitors is reduced with internal heating produced by ripple current at the rate of halving the lifetime with every 5°C rise. When long life performance is required in actual use , the rms ripple current has to be reduced.

HD

HD series

DIMENSIONS(mm)

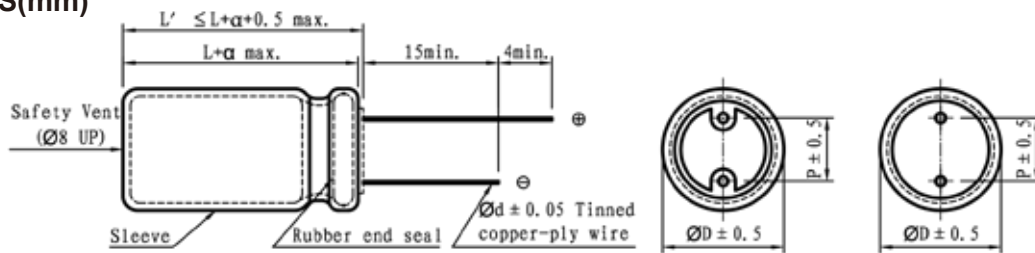

ϕD	8	10	13	16	18	22
P	3.5	5.0	5.0	7.5	7.5	10
ϕd	0.5	0.6	0.6	0.8	0.8	0.8

α	(L < 16) 1.0
	(L ≥ 16) 2.0

STANDARD RATINGS

D×L(mm) ; R.C.(mA rms) at 105°C 100KHz.

Cap (μF)	V	160		200		250		
		Item	D x L	R.C.	D x L	R.C.	D x L	R.C.
2.2			8x12	80	8x12	90	8x12	90
3.3			8x12	90	8x12	102	10x13	110
4.7			8x12	98	8x16	110	10x16	120
5.6			8x16	104	8x16	118	10x16	125
6.8			8x16	115	10x13	128	10x16	130
8.2			10x16	125	10x16	220	10x16	240
10			10x16	255	10x16	260	10x20	290
15			10x16	430	10x20	430	13x21	460
22			10x20	510	13x21	510	13x21	610
33			13x21	580	13x21	610	13x25	650
47			13x25	670	13x25	670	16x26	730
68			16x26	770	16x26	770	16x32	930
100			16x26	900	16x26	1030	18x32	1210
150			18x32	1270	18x35	1330	22x35	1530
220			18x35	1410	22x35	1710		

Cap (μF)	V	350		400		450		
		Item	D x L	R.C.	D x L	R.C.	D x L	R.C.
1			8x12	74	8x16	85	10x13	90
1.5			10x13	80	10x13	95	10x16	100
2.2			10x16	98	10x16	105	10x16	110
3.3			10x16	110	10x16	115	10x16	120
4.7			10x20	145	10x20	148	10x20	150
5.6			13x21	165	13x21	180	13x21	200
6.8			13x21	200	13x21	230	13x21	260
8.2			13x21	250	13x21	270	13x21	290
10			13x21	290	13x21	300	13x21	330
15			13x25	350	13x25	390	13x25	430
22			16x26	450	16x26	500	16x32	600
33			16x32	510	16x32	650	16x36	710
47			16x36	670	18x26	850	18x32	900
68			18x32	860	18x32	960	18x35	1150
82			18x32	1150	18x35	1300	18x40	1400
100			18x35	1250	18x40	1400		

※ 13mm may be replaced by 12.5mm upon customer's request.

HD

NK series

- On the basis of SD series ripple promotion product
- Suitable for LCD TV Power ,SMPS
- RoHS Compliance
- 高頻低阻抗,耐高紋波
- 105°C耐高溫、高紋波、長壽命。
- 適用於液晶顯示電源及開關電源等

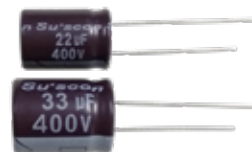

SPECIFICATIONS

Items 項目	Characteristics 特性			
Capacitance Tolerance 靜電容量誤差	± 20%(120Hz,20°C)			
Operating Temperature Range 適用溫度範圍	- 40 ~ +105°C			
Rated Voltage Range 額定電壓範圍	400VDC		450VDC~500VDC	
Leakage Current 洩漏電流	I ≤ 0.03CV + 20 (µA) (After 5 minutes application of DC rated voltage, at 20 °C)			
Dissipation Factor 散逸因素(tan δ)	Measurement Frequency:120Hz. Temperature: 20°C			
	Rated Voltage(V)	400V	450V	500V
	tan δ(Max)	0.15	0.18	0.20
When nominal capacitance over 1000µF, tanδ shall be added 0.02 to the listed value with increase of every 1000µF .				
Low Temperature Stability 低溫特性 Impedance Ratio(Max) 阻抗比率(最大值)	Measurement Frequency:120Hz			
	Rated Voltage(V)	400	450	500
	Z(-25°C)/Z(20°C)	5	6	6
	Z(-40°C)/Z(20°C)	10	12	12
Load Life 負荷壽命	The following specifications shall be satisfied when the capacitors are restored to 20°C after subjected to DC voltage with the rated ripple current is applied for 3,000 hours at 105°C.			
	Capacitance Change	Within ± 20% of Initial Value		
	tan δ	200% or less of Initial Specified Value		
	Leakage Current	Initial Specified Value or less		
Shelf Life 放置壽命	The following specifications shall be satisfied when the capacitors are restored to 20°C after exposing them for 1,000hours 105°C without voltage applied. Before the measurement. The capacitance shall be preconditioned by applying voltage according to them 4.1 of JIS C5101-4.			
	Capacitance Change	Within ± 20% of Initial Value		
	tan δ	200% or less of Initial Specified Value		
	Leakage Current	Initial Specified Value or less		
Standards 參照標準	JIS C 5101-4-1(IEC 60384)			

Frequency Coefficient of Permissible Ripple Current

Frequency (Hz)	50	120	1K	10K	100K
Coefficient	0.55	0.65	0.80	0.90	1.00

The endurance of capacitors is reduced with internal heating produced by ripple current at the rate of halving the lifetime with every 5°C rise. when long life performance is required in actual use. The rms ripple current has to be reduced.

NK series

DIMENSIONS(mm)

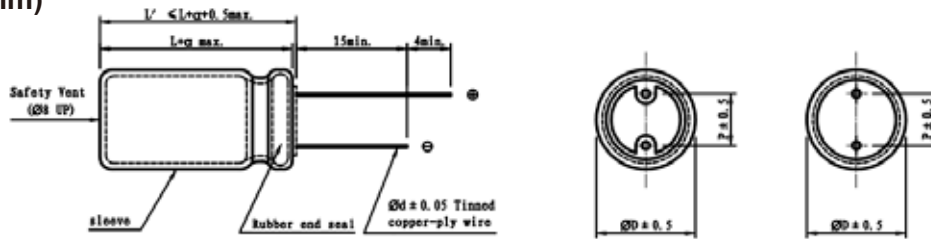

ϕD	6.3	8	10	13	16	18
P	2.5	3.5	5.0	5.0	7.5	7.5
ϕd	0.5	0.5	0.6	0.6	0.8	0.8

α	(L < 16) 1.0
	(L \geq 16) 2.0

STANDARD RATINGS

DxL(mm) ; R.C.(mA rms) at 105°C 100KHz ; IMP (Ω max)at 20°C 100KHz

Cap (μ F)	V Item	400			450			500		
		D x L	IMP	R.C.	D x L	IMP	R.C.	D x L	IMP	R.C.
4.7		6.3x12	9.5	120	6.3x16	15.6	115	6.3x16	17.4	82
					8x10	15.6	115	8x10	15.2	82
6.8		6.3x13	8.3	130	10x10	12.7	130	10x10	15.2	90
8.2		6.3x15	7.5	175	8x12	9.2	165	10x11	11.1	115
10					8x15	8.1	195	10x13	9.8	150
		8x10	5.3	195	10x11	8.1	195			
12		8x13	4.1	235	10x13	6.3	230	10x14	7.5	210
15		8x15	3.9	265	10x13.5	6.0	255	10x15	7.2	225
18		8x17	3.1	300	10x15	5.7	300	10x17	6.5	245
22		10x14	3.0	315	10x17	5.4	315	13x17	5.6	315
		8x18	3.0	315						
27		10x15	3.0	375	10x20	4.5	375	10x23	5.3	350
33		10x18	2.5	445	10x35	3.1	445	13x21	4.1	405
47		13x19	1.9	620	10x45	2.6	620	16x20	3.1	565
68		16x20	1.4	1010	10x50	1.6	1010	18x20	2.2	815
82		18x20	1.0	1200	16x25	1.3	1200	18x25	1.9	980
100		18x25	0.9	1350	18x25	1.0	1250			

※ 13mm may be replaced by 12.5mm upon customer's request.

SD series

- High frequency and low impedance, high ripple current resistance.
- Suitable for return-circuit of switching power source.
- RoHS Compliance.
- 高頻低阻抗、耐高紋波。
- 適用於開關電源迴路。



SPECIFICATIONS

Items 項目	Characteristics 特性											
Capacitance Tolerance 靜電容量誤差	± 20%(120Hz,20°C)											
Operating Temperature Range 適用溫度範圍	-40 ~ +105°C						-25 ~ +105°C					
Rated Voltage Range 額定電壓範圍	6.3 ~ 400VDC						450VDC					
Leakage Current 洩漏電流	$V \leq 100V$ $I \leq 0.01CV$ or 3 (μA) (After 2 minutes application of DC rated voltage, at 20°C) $V > 100V$ $I \leq 0.03CV + 20$ (μA) (After 5 minutes application of DC rated voltage, at 20°C)											
Dissipation Factor 散逸因素($\tan \delta$)	Measurement Frequency: 120Hz. Temperature: 20°C											
	Rated Voltage(V)	6.3	10	16	25	35	50	63~80	100	160~250	400~450	
	$\tan \delta$ (Max)	0.22	0.19	0.16	0.14	0.12	0.10	0.08	0.07	0.20	0.24	
When nominal capacitance over 1000 μF , $\tan \delta$ shall be added 0.02 to the listed value with increase of every 1000 μF .												
Low Temperature Stability 低溫特性 Impedance Ratio(Max) 阻抗比率(最大值)	Measurement Frequency: 120Hz.											
	Rated Voltage(V)	6.3	10	16	25	35	50	63	100	160~250	400	450
	$Z(-25^\circ C)/Z(20^\circ C)$	4	3	2	2	2	2	2	2	3	5	6
	$Z(-40^\circ C)/Z(20^\circ C)$	8	6	4	3	3	3	3	3	6	10	12
Load Life 負荷壽命	The following specifications shall be satisfied when the capacitors are restored to 20°C after subjected to DC voltage with the rated ripple current is applied for 2,000 hours at 105°C.											
	Capacitance Change	Within ± 20% of Initial Value										
	$\tan \delta$	200% or less of Initial Specified Value										
	Leakage Current	Initial Specified Value or less										
Shelf Life 放置壽命	The following specifications shall be satisfied when the capacitors are restored to 20°C after exposing them for 1,000 hours 105°C without voltage applied. Before the measurement, the capacitor shall be preconditioned by applying voltage according to them 4.1 of JIS C5101-4.											
	Capacitance Change	Within ± 20% of Initial Value										
	$\tan \delta$	200% or less of Initial Specified Value										
	Leakage Current	Initial Specified Value or less										
Standards 參照標準	JIS C 5101-4 (IEC 60384)											

Frequency Coefficient of Permissible Ripple Current

Rated Voltage (V)	Capacitance (μF)	Frequency (Hz)				
		50	120	1K	10K	100K
6.3 ~ 100	0.47 ~ 100	0.45	0.55	0.75	0.90	1.00
	220 ~ 1000	0.60	0.70	0.85	0.95	1.00
	1500 ~ 15000	0.70	0.80	0.95	0.98	1.00
160 ~ 450	2.2 ~ 330	0.55	0.65	0.80	0.90	1.00

The endurance of capacitors is reduced with internal heating produced by ripple current at the rate of halving the lifetime with every 5°C rise. When long life performance is required in actual use, the rms ripple current has to be reduced.

SD series

DIMENSIONS(mm)

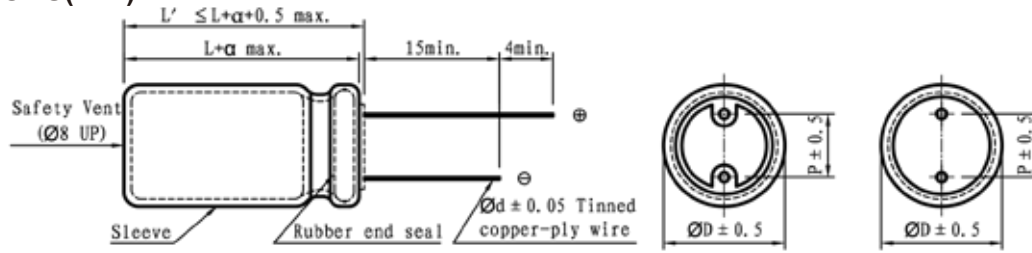

ϕD	5	6.3	8	10	13	16	18
P	2.0	2.5	3.5	5.0	5.0	7.5	7.5
ϕd	0.5	0.5	0.5	0.6	0.6	0.8	0.8

α	(L < 16) 1.0
	(L \geq 16) 2.0

STANDARD RATINGS

D×L(mm) ; R.C.(mA rms) at 105°C 100KHz ; IMP (Ω max)at 20°C 100KHz.

Cap (μ F)	V	6.3			10			16			25		
		Item	D x L	R.C.	IMP	D x L	R.C.	IMP	D x L	R.C.	IMP	D x L	R.C.
4.7											5x11	50	1.500
10											5x11	80	1.500
22											5x11	110	0.800
47					5x11	140	0.650	5x11	170	0.650	5x11	170	0.650
68					5x11	160	0.650	5x11	210	0.550	6.3x11	210	0.550
100					5x11	180	0.650	6.3x11	270	0.300	6.3x11	270	0.300
220	6.3x11	270	0.300	6.3x11	295	0.300	8x12	520	0.200	8x12	550	0.200	
330	6.3x11	320	0.300	8x12	528	0.200	8x12	550	0.200	10x13	720	0.100	
470	8x12	528	0.200	8x12	550	0.200	10x13	720	0.100	10x16	850	0.075	
680	8x12	550	0.200	10x13	760	0.100	10x16	850	0.075	10x20	1200	0.058	
1000	10x13	780	0.100	10x16	875	0.075	10x20	1200	0.058	13x21	1450	0.055	
1500	10x16	950	0.075	10x20	1250	0.058	13x21	1450	0.055	13x25	1850	0.040	
2200	10x25	1420	0.055	13x21	1450	0.055	13x25	1850	0.043	16x26	2250	0.030	
3300	13x21	1550	0.055	13x25	1850	0.043	16x26	2250	0.030	16x32	2850	0.027	
4700	13x25	1950	0.035	16x26	2250	0.030	16x32	2850	0.027	18x35	3120	0.025	
6800	16x26	2460	0.030	16x32	2850	0.027	18x35	3120	0.025	18x40	3650	0.023	
10000	16x32	2890	0.027	18x35	3120	0.025	18x40	3650	0.023				
15000	16x35	2950	0.025	18x40	3650	0.023							

Cap (μ F)	V	35			50			63			100		
		Item	D x L	R.C.	IMP	D x L	R.C.	IMP	D x L	R.C.	IMP	D x L	R.C.
0.47					5x11	25	7.500				5x11	20	15.00
1					5x11	40	5.300				5x11	30	15.00
2.2					5x11	55	4.500				5x11	44	9.800
3.3					5x11	65	3.900				5x11	58	6.600
4.7	5x11	85	2.000	5x11	90	2.300	5x11	65	4.494	5x11	74	4.600	
10	5x11	100	1.200	5x11	110	1.400	5x11	110	2.252	6.3x11	130	1.805	
22	5x11	120	1.000	5x11	140	1.200	6.3x11	200	1.000	8x12	280	1.360	
33	5x11	210	0.430	6.3x11	240	0.480	6.3x11	250	0.900	10x13	450	0.460	
47	6.3x11	270	0.300	6.3x11	240	0.480	8x12	420	0.800	10x16	650	0.390	
68	8x12	525	0.300	8x12	525	0.300	10x13	525	0.760	10x20	750	0.288	
100	8x12	550	0.200	8x12	550	0.250	10x13	550	0.580	13x21	950	0.208	
220	10x13	720	0.100	10x16	720	0.170	10x20	850	0.170	16x26	1250	0.104	
330	10x16	850	0.075	10x20	850	0.150	13x21	1250	0.142	16x32	1510	0.088	
470	10x20	1200	0.058	13x21	1450	0.090	13x25	1500	0.070	16x36	1720	0.072	
680	13x21	1450	0.055	13x25	1850	0.070	16x26	1780	0.055	18x35	1950	0.064	
1000	13x25	1850	0.043	16x26	2250	0.048	16x32	2120	0.043	18x40	2320	0.047	
1500	16x26	2250	0.030	16x32	2850	0.043	18x35	2310	0.033				
2200	16x32	2850	0.027	18x35	3120	0.040	18x40	2540	0.032				
3300	18x35	3120	0.025										
4700	18x40	3650	0.023										

※ 13mm may be replaced by 12.5mm upon customer's request.

SD

SD series

STANDARD RATINGS

D×L(mm) ; R.C.(mA rms) at 105°C 100KHz ; IMP (Ω max)at 20°C 100KHz.

Cap (μF)	V (Code)	160 (2C)			200 (2D)			250 (2E)		
	Item	D x L	R.C.	IMP	D x L	R.C.	IMP	D x L	R.C.	IMP
2.2								8x12	105	13.0
3.3		8x12	104	11.0	8x12	113	11.0	8x12	122	11.0
4.7		8x12	112	6.50	8x12	126	6.10	10x13	140	4.30
10		10x13	180	4.30	10x13	210	3.80	10x16	300	3.50
22		10x16	250	3.00	10x20	465	2.70	13x21	485	2.80
33		10x20	570	1.90	10x25	600	1.40	13x21	620	2.13
47		13x21	730	1.20	13x21	730	1.20	13x25	810	1.60
68		13x21	850	0.86	13x25	985	0.70	16x26	1010	1.07
100		16x26	1285	0.50	16x26	1285	0.50	16x32	1405	0.62
220		16x36	1450	0.29	18x32	1510	0.36	18x40	1490	0.38
330		18x35	1850	0.26						

Cap (μF)	V (Code)	400 (2G)			450 (2W)		
	Item	D x L	R.C.	IMP	D x L	R.C.	IMP
2.2		6.3x12	50	27	8x12	60	28
		8x12	80	13	10x13	90	23
3.3		8x12	90	16.5	8x12	80	23
		10x13	110	8.2	10x16	126	20
4.7		8x12	90	9.5	8x14	95	12.5
		10x16	160	4.8	10x20	170	6.2
10		10x16	170	6.1	10x16	160	7.5
		10x20	195	3.0	13x21	280	3.7
22		13x21	290	4.0	13x21	280	7.0
		13x25	350	1.95	16x26	580	3.5
33		13x21	400	3.00	13x25	420	3.6
		13x25	480	1.50	16x26	610	1.6
47		13x25	530	1.25	16x26	650	1.9
		16x26	720	0.61	16x32	850	0.85
68		16x26	750	1.10	18x32	940	0.71
		16x32	820	0.55			
100		18x26	850	1.00	18x35	1000	1.00
		18x35	950	0.48	18x40	1100	0.43

※ 13mm may be replaced by 12.5mm upon customer's request.

SD

SDA series

- On the basis of SD series ripple promotion product.
- Suitable for LCD TV Power, SMPS.
- RoHS Compliance.
- SD系列紋波提升品。
- 適用於液晶顯示電源及開關電源等。



SPECIFICATIONS

Items 項目	Characteristics 特性				
Capacitance Tolerance 靜電容量誤差	± 20%(120Hz,20°C)				
Operating Temperature Range 適用溫度範圍	-40 ~ +105°C		-25 ~ +105°C		
Rated Voltage Range 額定電壓範圍	400VDC		450 ~ 500VDC		
Leakage Current 洩漏電流	$I \leq 0.03CV + 20 (\mu A)$ (After 1 minutes application of DC rated voltage, at 20 °C)				
Dissipation Factor 散逸因素(tan δ)	Measurement Frequency: 120Hz. Temperature: 20°C				
	Rated Voltage(V)	400	450	460	500
	tan δ(Max)	0.15	0.20	0.20	0.20
When nominal capacitance over 1000µF, tanδ shall be added 0.02 to the listed value with increase of every 1000µF .					
Low Temperature Stability 低溫特性 Impedance Ratio(Max) 阻抗比率(最大值)	Measurement Frequency: 120Hz.				
	Rated Voltage(V)	400	450	460	500
	Z(-25°C)/Z(20°C)	3	3	6	6
	Z(-40°C)/Z(20°C)	6	-	-	-
Load Life 負荷壽命	The following specifications shall be satisfied when the capacitors are restored to 20°C after subjected to DC voltage with the rated ripple current is applied for 2,000 hours at 105°C.				
	Capacitance Change	Within ± 20% of Initial Value			
	tan δ	200% or less of Initial Specified Value			
	Leakage Current	Initial Specified Value or less			
Shelf Life 放置壽命	The following specifications shall be satisfied when the capacitors are restored to 20°C after exposing them for 1,000 hours 105°C without voltage applied. Before the measurement. The capacitor shall be preconditioned by applying voltage according to them 4.1 of JIS C5101-4.				
	Capacitance Change	Within ± 20% of Initial Value			
	tan δ	200% or less of Initial Specified Value			
	Leakage Current	Initial Specified Value or less			
Standards 參照標準	JIS C 5101-4-1 (IEC 60384)				

Frequency Coefficient of Permissible Ripple Current

Capacitance (µF)	Frequency (Hz)				
	120	10K	30K	50K	100K
10 ~ 150	1.00	1.50	1.60	1.75	2.00

The endurance of capacitors is reduced with internal heating produced by ripple current at the rate of halving the lifetime with every 5°C rise. When long life performance is required in actual use . The rms ripple current has to be reduced.

SDA series

DIMENSIONS(mm)

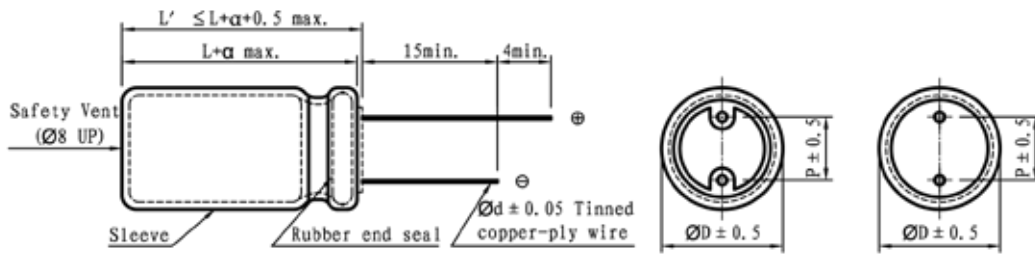

ϕD	10	13	16	18	20	22
P	5.0	5.0	7.5	7.5	10	10
ϕd	0.6	0.6	0.8	0.8	0.8	0.8

α	(L < 16) 1.0 (L \geq 16) 2.0
----------	-----------------------------------

STANDARD RATINGS

D×L(mm) ; R.C.(mA rms) at 105°C 120Hz.

Cap (μF)	V	400				450				460				500			
		Item	D x L	R.C.		D x L	R.C.		D x L	R.C.		D x L	R.C.				
				120Hz	100KHz		120Hz	100KHz		120Hz	100KHz		120Hz	100KHz			
10		10x16	120	240	10x20	170	340	10x20	150	300	13x21	83	166				
15		10x20	230	460	13x21	230	460	13x21	200	400	13x21	110	220				
22		13x21	300	600	13x21	350	700	13x25	350	700	13x25	200	400				
33		13x21	380	760	13x25	400	800	16x25	480	960	16x25	300	600				
47		13x25	400	800	16x25	530	1060	18x26	530	1060	18x26	330	660				
56		16x25	550	1100	18x26	630	1260	18x26	600	1200	18x32	350	700				
68		16x25	700	1400	18x32	690	1380	18x32	690	1380	18x35	480	960				
82		18x26	780	1560	18x32	750	1500	18x32	750	1500	18x40	590	1180				
100		18x32	830	1660	18x35	800	1600	18x35	800	1600	18x45	680	1360				
120		18x35	900	1800	18x40	950	1900	18x40	950	1900	20x45	730	1460				
150		18x40	1000	2000	18x45	1050	2100	20x45	1300	2600	22x45	780	1560				

※ 13mm may be replaced by 12.5mm upon customer's request.

MC series

- Low Impedance, high ripple current resistance, 2000~3000 hours load life.
- Suitable for output return circuit of switching power supply for IT products.
- RoHS Compliance.
- 低阻抗、耐高紋波，2000~3000小時壽命。
- 適於電腦之開關電源供應器的輸出迴路。

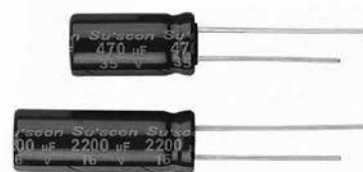

SPECIFICATIONS

Items 項目	Characteristics 特性												
Capacitance Tolerance 靜電容量誤差	± 20%(120Hz,20°C)												
Operating Temperature Range 適用溫度範圍	-40 ~ +105°C						-25 ~ +105°C						
Rated Voltage Range 額定電壓範圍	6.3 ~ 400VDC						450VDC						
Leakage Current 洩漏電流	$V \leq 100V$ I $\leq 0.01CV$ or 3 (μA) (After 2 minutes application of DC rated voltage, at 20°C) $V > 100V$ I $\leq 0.03CV + 20$ (μA) (After 5 minutes application of DC rated voltage, at 20°C)												
Dissipation Factor 散逸因素(tan δ)	Measurement Frequency: 120Hz. Temperature: 20°C												
	Rated Voltage(V)	6.3	10	16	25	35	50	63	100	160~250	350	400~450	
	tan δ (Max)	0.20	0.17	0.16	0.14	0.12	0.10	0.08	0.08	0.15	0.20	0.25	
Low Temperature Stability 低溫特性 Impedance Ratio(Max) 阻抗比率(最大值)	Measurement Frequency: 120Hz.												
	Rated Voltage(V)	6.3	10	16	25	35	50	63~100	160~350	400~450			
	Z(-25°C)/Z(20°C)	4	3	2	2	2	2	2	3	6			
	Z(-40°C)/Z(20°C)	8	6	4	3	3	3	3	6	12			
Load Life 負荷壽命	The following specifications shall be satisfied when the capacitors are restored to 20°C after subjected to DC voltage with the rated ripple current is applied for 3,000 hours($\phi D \leq 8$:2,000 hours) at 105°C.												
	Capacitance Change	Within ± 20% of Initial Value											
	tan δ	200% or less of Initial Specified Value											
	Leakage Current	Initial Specified Value or less											
Shelf Life 放置壽命	The following specifications shall be satisfied when the capacitors are restored to 20°C after exposing them for 1,000 hours 105°C without voltage applied. Before the measurement, the capacitor shall be preconditioned by applying voltage according to them 4.1 of JIS C5101-4.												
	Capacitance Change	Within ± 20% of Initial Value											
	tan δ	200% or less of Initial Specified Value											
	Leakage Current	Initial Specified Value or less											
Standards 參照標準	JIS C 5101-4 (IEC 60384)												

Frequency Coefficient of Permissible Ripple Current

Rated Voltage (V)	Capacitance (μF)	Frequency (Hz)				
		50	120	1K	10K	100K
6.3 ~ 100	0.47 ~ 100	0.45	0.55	0.75	0.90	1.00
	220 ~ 1000	0.60	0.70	0.85	0.95	1.00
	1500 ~ 15000	0.70	0.80	0.95	0.98	1.00
160 ~ 450	2.2 ~ 330	0.55	0.65	0.80	0.90	1.00

The endurance of capacitors is reduced with internal heating produced by ripple current at the rate of halving the lifetime with every 5°C rise. When long life performance is required in actual use , the rms ripple current has to be reduced.

MC series

DIMENSIONS(mm)

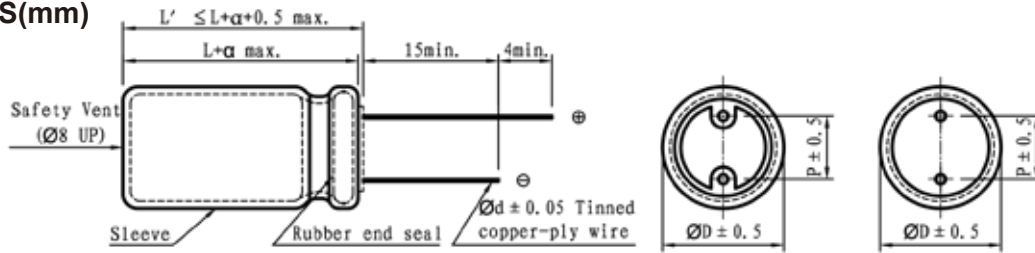

ϕD	5	6.3	8	10	13	16	18
P	2.0	2.5	3.5	5.0	5.0	7.5	7.5
ϕd	0.5	0.5	0.5	0.6	0.6	0.8	0.8

α	(L < 16) 1.0
	(L ≥ 16) 2.0

STANDARD RATINGS

D×L(mm) ; R.C.(mA rms) at 105°C 100KHz ; IMP (Ω max)at 20°C 100KHz.

Cap (μ F)	V	6.3			10			16			25		
		Item	D x L	R.C.	IMP	D x L	R.C.	IMP	D x L	R.C.	IMP	D x L	R.C.
33											5x11	155	0.800
39											5x11	175	0.650
47								5x11	155	0.800	6.3x11	210	0.550
56								5x11	175	0.650	6.3x11	235	0.440
68					5x11	155	0.800	6.3x11	220	0.500	6.3x11	260	0.336
82					5x11	175	0.650	6.3x11	240	0.420	6.3x11	285	0.330
100		5x11	200	0.620	6.3x11	200	0.420	6.3x11	255	0.370	8x12	520	0.220
220		6.3x11	275	0.320	8x12	360	0.220	8x12	550	0.140	8x14	600	0.100
270		6.3x11	320	0.250	8x12	420	0.185	8x16	650	0.140	8x20	750	0.095
330		8x12	530	0.180	8x12	550	0.140	10x13	750	0.100	10x16	800	0.069
470		10x13	750	0.140	10x13	750	0.100	10x16	800	0.085	10x20	1050	0.064
680		10x16	950	0.100	10x16	800	0.085	10x20	1050	0.064	13x21	1370	0.049
1000		10x16	980	0.069	10x20	1080	0.065	13x21	1360	0.039	13x25	1600	0.038
2200		10x25	1450	0.043	13x25	1650	0.038	13x30	2050	0.028	13x40	2300	0.024
3300		13x25	1750	0.035	13x35	2100	0.028	13x40	2360	0.024	16x36	2600	0.019
3900		13x30	1910	0.034	13x40	2360	0.024	16x32	2470	0.022	16x40	2950	0.019
4700		13x35	2050	0.028	16x32	2370	0.024	16x36	2600	0.019	18x40	3500	0.019
6800		16x32	2300	0.024	16x36	2600	0.019	18x35	2900	0.019			
8200		16x36	2650	0.021	18x35	2900	0.019	18x40	3500	0.017			
10000		18x32	2850	0.019	18x40	3500	0.018						
15000		18x40	3500	0.019									

※ 13mm may be replaced by 12.5mm upon customer's request.

MC

MC series

STANDARD RATINGS

D×L(mm) ; R.C.(mA rms) at 105°C 100KHz ; IMP (Ω max)at 20°C 100KHz.

Cap (μF)	V	35			50			63			100		
		Item	D x L	R.C.	IMP	D x L	R.C.	IMP	D x L	R.C.	IMP	D x L	R.C.
47					8x12	350	0.350	8x12	450	0.300	10x25	850	0.350
68		8x12	360	0.220	8x12	450	0.250	8x16	550	0.220	13x21	1100	0.240
100		8x12	450	0.140	10x16	850	0.200	10x20	700	0.170	13x25	1250	0.180
220		10x16	880	0.069	10x20	1100	0.100	13x21	1300	0.150	16x32	1850	0.071
330		10x20	1100	0.044	13x21	1300	0.095	13x25	1400	0.070	18x40	2350	0.049
470		13x21	1370	0.039	13x25	1450	0.070	13x35	1650	0.047			
680		13x25	1600	0.038	13x35	1800	0.040	16x32	2000	0.037			
1000		13x30	1930	0.029	16x32	2100	0.034	18x35	2200	0.034			
2200		16x36	2550	0.019	18x40	2800	0.025						
3300		18x40	3150	0.019									

Cap (μF)	V	160			200			250		
		Item	D x L	R.C.	IMP	D x L	R.C.	IMP	D x L	R.C.
2.2								8x12	85	13.0
3.3		8x12	85	11.0	8x12	90	11.0	8x12	97	11.0
4.7		8x12	90	6.50	8x12	100	6.10	10x13	112	4.30
10		10x13	144	4.30	10x13	168	3.80	10x16	240	3.50
22		10x16	200	3.00	10x20	372	2.70	13x21	388	2.80
33		10x20	450	2.50	10x25	480	2.30	13x21	495	2.20
47		13x21	580	2.00	13x21	584	2.00	13x25	650	1.80
68		13x21	680	1.05	13x25	788	0.98	16x26	810	0.90
100		16x26	1028	0.90	16x26	1030	0.90	16x32	1124	0.85
220		16x36	1160	0.80	18x32	1208	0.75	18x40	1200	0.70
330		18x35	1480	0.70						

Cap (μF)	V	400			450		
		Item	D x L	R.C.	IMP	D x L	R.C.
2.2		8x12	65	7.60	10x13	75	9.50
3.3		10x13	88	5.20	10x16	100	7.90
4.7		10x16	128	3.85	10x20	115	6.20
10		10x20	156	3.10	13x21	224	3.70
22		13x25	280	2.10	16x26	460	1.00
33		13x25	460	1.78	16x26	488	0.95
47		16x26	580	1.36	16x32	680	0.85
68		16x32	960	0.96	18x32	750	0.71
100		18x35	1000	0.78	18x40	880	0.43

※ 13mm may be replaced by 12.5mm upon customer's request.

MC

MF series

- Low impedance, high reliability, 2000~5000 hours load life.
- Suitable for switching regulator of computer, etc.
- RoHS Compliance
- 低阻抗、高信賴性、2000~5000小時壽命。
- 適用於電腦類開關調節器。



SPECIFICATIONS

Items 項目	Characteristics 特性											
Capacitance Tolerance 靜電容量誤差	± 20%(120Hz,20°C)											
Operating Temperature Range 適用溫度範圍	-40 ~ +105°C						-25 ~ +105°C					
Rated Voltage Range 額定電壓範圍	6.3 ~ 400VDC						450VDC					
Leakage Current 洩漏電流	$V \leq 100V I \leq 0.01CV$ or $3 (\mu A)$ (After 2 minutes application of DC rated voltage, at 20°C) $V > 100V I \leq 0.03CV + 20 (\mu A)$ (After 5 minutes application of DC rated voltage, at 20°C)											
Dissipation Factor 散逸因素($\tan \delta$)	Measurement Frequency: 120Hz. Temperature: 20°C											
	Rated Voltage(V)	6.3	10	16	25	35	50	63	100	120~250	350	400~450
	$\tan \delta$ (Max)	0.20	0.17	0.16	0.14	0.12	0.10	0.08	0.08	0.15	0.20	0.25
Low Temperature Stability 低溫特性 Impedance Ratio(Max) 阻抗比率(最大值)	Measurement Frequency: 120Hz.											
	Rated Voltage(V)	6.3	10	16	25	35	50	63~100	160~250	350~400	450	
	$Z(-25^\circ C)/Z(20^\circ C)$	4	3	2	2	2	2	2	3	6	15	
	$Z(-40^\circ C)/Z(20^\circ C)$	8	6	4	3	3	3	3	4	10	-	
Load Life 負荷壽命	The following specifications shall be satisfied when the capacitors are restored to 20°C after subjected to DC voltage with the rated ripple current is applied for 5,000 hours ($\phi D \leq 6.3:2,000$ hours; $\phi D = 8:3,000$ hours) at 105°C.											
	Capacitance Change	Within ± 20% of Initial Value										
	$\tan \delta$	200% or less of Initial Specified Value										
	Leakage Current	Initial Specified Value or less										
Shelf Life 放置壽命	The following specifications shall be satisfied when the capacitors are restored to 20°C after exposing them for 1,000 hours 105°C without voltage applied. Before the measurement, the capacitor shall be preconditioned by applying voltage according to them 4.1 of JIS C5101-4.											
	Capacitance Change	Within ± 20% of Initial Value										
	$\tan \delta$	150% or less of Initial Specified Value										
	Leakage Current	Initial Specified Value or less										
Standards 參照標準	JIS C 5101-4 (IEC 60384)											

Frequency Coefficient of Permissible Ripple Current

Rated Voltage (V)	Capacitance (µF)	Frequency (Hz)				
		50	120	1K	10K	100K
6.3 ~ 100	10 ~ 150	0.60	0.70	0.85	0.95	1.00
	220 ~ 1800	0.65	0.75	0.90	0.98	1.00
	2200 ~ 15000	0.75	0.80	1.00	1.00	1.00
160 ~ 450	1 ~ 330	0.55	0.65	0.80	0.90	1.00

The endurance of capacitors is reduced with internal heating produced by ripple current at the rate of halving the lifetime with every 5°C rise. When long life performance is required in actual use, the rms ripple current has to be reduced.

MF series

DIMENSIONS(mm)

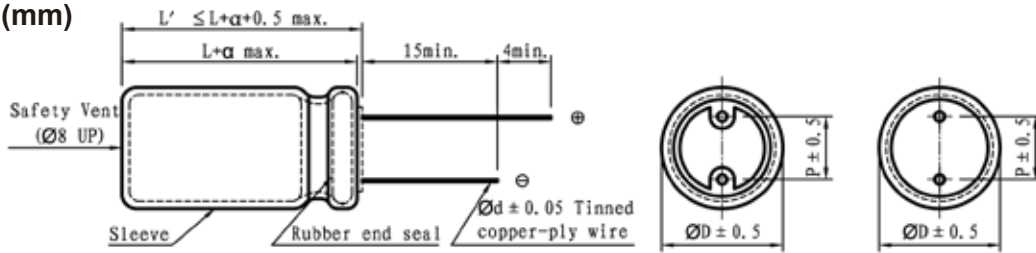

φ D	5	6.3	8	10	13	16	18
P	2.0	2.5	3.5	5.0	5.0	7.5	7.5
φ d	0.5	0.5	0.5	0.6	0.6	0.8	0.8

STANDARD RATINGS

D×L(mm) ; R.C.(mA rms) at 105°C 100KHz ; IMP (Ω max)at 20°C 100KHz.

Cap (μF)	V	6.3			10			16			25		
		Item	D x L	R.C.	IMP	D x L	R.C.	IMP	D x L	R.C.	IMP	D x L	R.C.
33											5x11	145	0.920
47								5x11	180	0.650	6.3x11	210	0.600
100		5x11	140	0.920	5x11	180	0.650	5x11	230	0.550	6.3x11	370	0.350
220		6.3x11	275	0.300	6.3x11	340	0.300	8x12	580	0.280	8x12	640	0.230
330		6.3x11	320	0.300	8x12	580	0.280	8x12	640	0.230	10x13	865	0.080
470		8x12	580	0.280	8x12	640	0.230	8x16	840	0.150	10x16	1210	0.060
560		8x12	640	0.230	10x13	780	0.160	10x13	880	0.100	10x16	1320	0.055
680		8x12	720	0.140	10x13	820	0.110	10x16	1000	0.085	10x20	1380	0.052
820		8x16	840	0.087	8x16	865	0.080	10x16	1040	0.076	10x20	1400	0.046
1000		10x13	865	0.080	10x16	1040	0.076	10x20	1210	0.060	13x21	1900	0.035
1200		10x16	960	0.064	10x16	1210	0.060	10x25	1580	0.042	13x25	2058	0.032
1500		10x16	1210	0.060	10x20	1400	0.058	13x21	1870	0.035	13x25	2124	0.030
1800		10x20	1400	0.058	13x21	1580	0.042	13x21	1900	0.032	13x30	2340	0.028
2200		10x25	1450	0.046	13x21	1900	0.032	13x25	2124	0.030	13x35	2450	0.026
2700		13x21	1580	0.042	13x25	2124	0.030	13x30	2340	0.028	13x35	2743	0.024
3300		13x21	1870	0.035	13x30	2340	0.028	13x35	2450	0.026	16x32	3029	0.022
3900		13x21	1900	0.032	13x35	2450	0.026	16x26	2500	0.028	16x36	3124	0.020
4700		13x25	2124	0.030	16x26	2500	0.028	16x32	3029	0.022	18x35	3638	0.019
5600		13x30	2524	0.026	16x26	2552	0.026	16x36	3124	0.020	18x40	3781	0.016
6800		16x26	2760	0.028	16x32	3029	0.022	16x40	3586	0.019			
8200		16x32	3029	0.022	16x32	3600	0.020	18x35	3750	0.018			
10000		16x36	3124	0.020	18x35	3638	0.019						
12000		18x32	3600	0.020									
15000		18x35	3781	0.018									

Cap (μF)	V	35			50			63			100		
		Item	D x L	R.C.	IMP	D x L	R.C.	IMP	D x L	R.C.	IMP	D x L	R.C.
10					5x11	120	1.400	5x11	125	1.650	6.3x11	130	1.250
22		5x11	150	0.920	5x11	160	1.200	6.3x11	240	0.780	8x12	230	0.850
33		5x11	220	0.430	6.3x11	230	0.300	8x12	270	0.650	10x13	330	0.690
47		6.3x11	280	0.300	6.3x11	295	0.300	8x12	300	0.504	10x13	370	0.450
100		8x12	450	0.200	10x13	760	0.120	10x16	610	0.160	10x25	560	0.300
220		10x13	760	0.100	10x16	1150	0.078	10x20	1100	0.120	13x25	880	0.280
330		10x16	1210	0.060	13x21	1660	0.055	13x21	1280	0.100	16x26	1440	0.130
470		10x20	1400	0.058	13x25	1950	0.046	13x25	1710	0.082	18x32	1690	0.110
560		13x21	1660	0.055	13x25	2124	0.034	16x26	1820	0.058	18x35	2020	0.043
680		13x21	1900	0.035	13x30	2310	0.030	16x26	1850	0.055	18x35	2100	0.043
820		13x25	2124	0.030	13x35	2510	0.025	16x32	2250	0.043			
1000		13x25	2340	0.028	13x35	2920	0.022	16x36	2450	0.036			
1200		13x30	2524	0.026	16x32	3010	0.022	18x32	2580	0.031			
1500		16x26	2600	0.026	16x36	3150	0.020						
1800		16x26	2850	0.025	18x32	3635	0.020						
2200		16x32	3029	0.022	18x35	3680	0.017						
2700		18x32	3600	0.020									
3300		18x40	3781	0.015									

※ 13mm may be replaced by 12.5mm upon customer's request.

MF

MF series

STANDARD RATINGS

D×L(mm) ; R.C.(mA rms) at 105°C 100KHz ; IMP(Ω max)at 20°C 100KHz

Cap (μF)	V Item	160		200		250	
		D x L	R.C.	D x L	R.C.	D x L	R.C.
4.7						8x12	150
10		10x16	330	10x16	330	10x16	330
22		10x20	510	10x20	510	10x20	510
33		10x20	650	10x20	650	13x21	800
47		10x20	750	13x21	980	13x21	980
100		13x25	1420	16x25	1580	16x32	1750
150		16x25	1900	16x25	1900	18x32	2050
330		18x25	2100	18x32	2300		

Cap (μF)	V Item	350		400		450	
		D x L	R.C.	D x L	R.C.	D x L	R.C.
2.2				10x13	150		
3.3				10x13	160		
4.7		10x13	140	10x16	230	10x20	210
10		10x20	350	10x20	350	13x21	450
22		13x21	640	13x21	640	16x22	750
33		16x22	850	16x22	850	16x25	950
47		16x25	1030	16x25	1030	18x25	1050
100		16x32	1180	18x32	1180	18x35	1230

※ 13mm may be replaced by 12.5mm upon customer's request.

HF series

- Ultra Low impedance at High frequency range.
- High ripple current, 105°C 4000~8000hours long life.
- RoHS Compliance
- 高頻低阻抗。
- 高紋波電流、105°C 4000~8000小時長壽命產品。

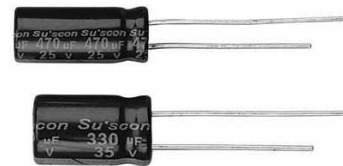

SPECIFICATIONS

Items 項目	Characteristics 特性								
Capacitance Tolerance 靜電容量誤差	± 20%(120Hz,20°C)								
Operating Temperature Range 適用溫度範圍	-40 ~ +105°C								
Rated Voltage Range 額定電壓範圍	6.3 ~ 100VDC								
Leakage Current 洩漏電流	I ≤ 0.01CV or 3 (μA) which is greater.(After 2 minutes application of DC rated voltage, at 20 °C)								
Dissipation Factor 散逸因素(tan δ)	Measurement Frequency:120Hz. Temperature: 20°C								
	Rated Voltage(V)	6.3	10	16	25	35	50	63	100
	tan δ(Max)	0.22	0.19	0.16	0.14	0.12	0.10	0.09	0.08
When nominal capacitance over 1000μF, tanδ shall be added 0.02 to the listed value with increase of every 1000μF.									
Low Temperature Stability 低溫特性 Impedance Ratio(Max) 阻抗比率(最大值)	Measurement Frequency: 120Hz.								
	Rated Voltage(V)	6.3	10	16	25	35	50	63	100
	Z(-25°C)/Z(20°C)	4	3	2	2	2	2	2	2
Z(-40°C)/Z(20°C)									
Load Life 負荷壽命	The following specifications shall be satisfied when the capacitors are restored to 20°C after subjected to DC voltage with the rated ripple current is applied for varied hours according to varied φ [please refer to below sheet] at 105°C.								
	Time	φ	5	6.3	8	10	12.5~13	14.5~16	18
		hours	4000	4000	5000	6000	7000	8000	8000
	Capacitance Change	within ±20% of Initial Value							
	tan δ	200% or less of Initial Specified Value							
Leakage Current	Initial Specified Value or less								
Shelf Life 放置壽命	The following specifications shall be satisfied when the capacitors are restored to 20°C after exposing them for 1,000 hours 105°C without voltage applied. Before the measurement, the capacitor shall be preconditioned by applying voltage according to them 4.1 of JIS C5101-4.								
	Capacitance Change	within ±20% of Initial Value							
	tan δ	200% or less of Initial Specified Value							
Leakage Current	Initial Specified Value or less								
Standards 參照標準	JIS C 5101-4 (IEC 60384)								

Frequency Coefficient of Permissible Ripple Current

Capacitance (μF)	Frequency (Hz)			
	120	1K	10K	100K
5.6 ~ 180	0.40	0.75	0.90	1.00
220 ~ 560	0.50	0.85	0.94	1.00
680 ~ 1800	0.60	0.87	0.95	1.00
2200 ~ 3900	0.75	0.90	0.95	1.00
4700 ~ 18000	0.85	0.95	0.98	1.00

The endurance of capacitors is reduced with internal heating produced by ripple current at the rate of halving the lifetime with every 5°C rise. When long life performance is required in actual use , the rms ripple current has to be reduced.

HF series

DIMENSIONS(mm)

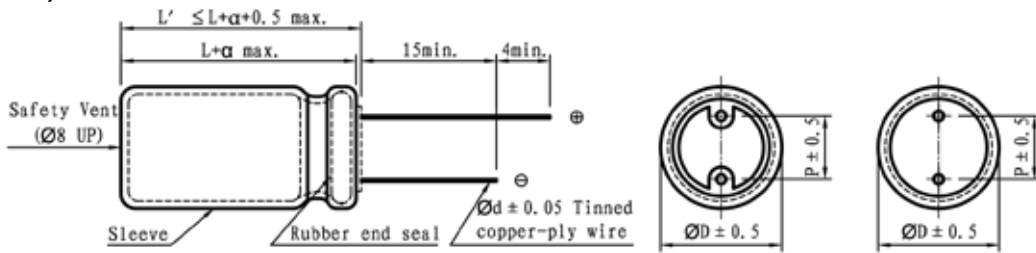

φ D	5	6.3	8	10	13	16	18
P	2.0	2.5	3.5	5.0	5.0	7.5	7.5
φ d	0.5	0.5	0.5	0.6	0.6	0.8	0.8

STANDARD RATINGS

D×L(mm) ; R.C.(mA rms) at 105°C 100KHz ; IMP (Ω max)at 20°C, -10°C 100KHz.

Cap (μF)	V	6.3				10				16				25				
		Item	D x L	IMP		R.C.	D x L	IMP		R.C.	D x L	IMP		R.C.	D x L	IMP		R.C.
				20°C	-10°C			20°C	-10°C			20°C	-10°C			20°C	-10°C	
47										5x11	0.500	1.000	170	5x11	0.490	1.000	175	
100						5x11	0.500	1.000	170	6.3x11	0.250	0.500	295	6.3x11	0.250	0.500	295	
150		5x11	0.500	1.000	170									6.3x15	0.180	0.350	420	
220						6.3x11	0.240	0.500	295	6.3x15	0.170	0.360	410	8x12	0.120	0.240	650	
330		6.3x11	0.240	0.500	295	6.3x15	0.180	0.350	400	8x12	0.120	0.230	660	8x16	0.090	0.180	750	
390														10x13	0.090	0.180	770	
470		6.3x15	0.180	0.360	400	8x12	0.120	0.230	650	8x20	0.080	0.160	830	8x20	0.079	0.150	820	
560																		
680		8x12	0.120	0.240	655	8x16	0.090	0.180	830	8x16	0.089	0.180	740	10x16	0.067	0.136	1060	
820		10x13	0.091	0.180	860	10x13	0.090	0.180	860	10x13	0.090	0.180	770	10x16	0.067	0.136	1060	
1000		8x16	0.091	0.190	830	8x20	0.080	0.150	1010	8x20	0.080	0.160	830	10x20	0.067	0.136	1060	
1200		8x20	0.082	0.170	1060	10x16	0.067	0.136	1250	10x16	0.067	0.136	1060	10x20	0.052	0.103	1420	
1500		10x16	0.067	0.136	1250	10x20	0.052	0.103	1420	10x25	0.045	0.090	1450	10x25	0.045	0.090	1450	
1800		10x20	0.051	0.103	1420	10x25	0.044	0.090	1640	10x30	0.036	0.074	1700	13x25	0.030	0.060	1960	
2200		10x25	0.044	0.090	1640	10x30	0.036	0.074	1930	13x21	0.038	0.077	1650	13x21	0.038	0.077	1650	
2700		10x30	0.038	0.075	1930	13x21	0.038	0.077	1650	13x25	0.030	0.060	1970	13x25	0.030	0.060	1970	
3300		13x21	0.037	0.075	1650	13x25	0.030	0.060	1960	13x30	0.024	0.050	2330	13x30	0.024	0.050	2330	
3900		13x25	0.030	0.060	1960	13x30	0.024	0.050	2320	16x22	0.028	0.058	2220	16x22	0.028	0.058	2220	
4700		13x30	0.024	0.050	2320	13x35	0.022	0.043	2520	18x20	0.028	0.055	2490	18x20	0.028	0.055	2490	
5600		13x35	0.021	0.043	2520	13x40	0.017	0.034	2880	16x32	0.018	0.038	3020	16x32	0.018	0.038	3020	
6300		16x22	0.028	0.057	2230	16x26	0.022	0.044	2570	18x25	0.020	0.040	2750	18x25	0.020	0.040	2750	
6800		18x20	0.027	0.055	2490	18x20	0.027	0.056	2490	16x40	0.014	0.030	3720	16x40	0.014	0.030	3720	
8200		16x32	0.019	0.038	3020	16x36	0.017	0.034	3150	18x35	0.016	0.032	3670	18x35	0.016	0.032	3670	
10000		18x32	0.017	0.035	3340	18x32	0.017	0.036	3340	18x35	0.016	0.032	3670	18x35	0.016	0.032	3670	
12000		16x40	0.015	0.030	3720	16x40	0.015	0.030	3720	18x40	0.015	0.030	3810	18x40	0.015	0.030	3810	
15000		18x32	0.017	0.035	3340	18x32	0.017	0.036	3340	18x40	0.015	0.030	3810	18x40	0.015	0.030	3810	
18000		18x35	0.016	0.031	3670	18x35	0.016	0.031	3670									
		18x40	0.015	0.030	3810	18x40	0.015	0.030	3810									

※ 13mm may be replaced by 12.5mm upon customer's request.

HF

HF series

STANDARD RATINGS

D×L(mm) ; R.C.(mA rms) at 105°C 100KHz ; IMP (Ω max)at 20°C,-10°C 100KHz.

Cap (μF)	V	35			50			63			100							
		Item	D x L	IMP		R.C.	D x L	IMP		R.C.	D x L	IMP		R.C.				
				20°C	-10°C			20°C	-10°C			20°C	-10°C		20°C	-10°C		
5.6																		
12									5x11	1.800	4.000	145	6.3x11	1.200	3.100	120		
18													6.3x15	0.620	1.800	200		
22						5x11	0.900	1.800	165	6.3x11	1.000	2.000	250	8x12	0.540	1.600	250	
27														10x13	0.480	1.400	350	
33	5x11	0.490	1.000	185										8x16	0.74	2.000	320	
														10x16	0.62	1.650	460	
39									6.3x15	0.600	1.400	340	8x20	0.280	0.750	450		
47					6.3x11	0.440	0.900	270										
56	6.3x11	0.250	0.500	300									10x20	0.270	0.710	580		
68					6.3x15	0.310	0.620	370	8x12	0.340	0.740	410	10x25	0.200	0.530	760		
100	6.3x15	0.170	0.360	410	8x12	0.210	0.430	490	8x16	0.260	0.650	540	10x30	0.160	0.430	910		
									10x13	0.254	0.510	550	13x21	0.160	0.430	840		
120					8x16	0.160	0.320	640										
					10x13	0.150	0.320	630	10x16	0.190	0.380	620	13x25	0.120	0.320	1010		
150	8x12	0.120	0.230	625					8x20	0.210	0.510	690	13x21	0.250	0.650	950		
180					8x20	0.120	0.240	740					13x30	0.130	0.360	1220		
					10x16	0.130	0.250	860	10x20	0.144	0.290	890	16x22	0.120	0.320	1200		
220	8x16	0.090	0.180	740									13x35	0.088	0.250	1420		
	10x13	0.090	0.170	770	10x20	0.087	0.180	1060	10x25	0.130	0.260	1060	16x26	0.082	0.230	1400		
270	8x20	0.079	0.160	820									13x40	0.060	0.180	1600		
													18x20	0.085	0.240	1400		
330	10x16	0.067	0.136	1060	10x25	0.073	0.150	1260	10x30	0.090	0.180	1310	16x32	0.059	0.180	1740		
									13x21	0.084	0.170	1290	18x25	0.070	0.200	1610		
390					10x30	0.054	0.110	1520					16x36	0.053	0.150	1950		
					13x21	0.058	0.120	1490	13x25	0.070	0.140	1730	18x32	0.059	0.170	1820		
470	10x20	0.052	0.103	1230					13x30	0.054	0.110	2100						
									16x22	0.058	0.120	1780	16x40	0.056	0.160	2100		
560	10x25	0.044	0.090	1450	13x25	0.044	0.087	1850					18x35	0.053	0.150	2150		
680	10x30	0.037	0.073	1700	13x30	0.038	0.078	2230	13x35	0.046	0.093	2280						
									16x26	0.050	0.100	2170	18x40	0.042	0.120	2300		
	13x21	0.038	0.076	1670	16x22	0.047	0.095	1850	18x20	0.054	0.110	2300						
820					13x35	0.033	0.065	2300	13x40	0.042	0.084	2570						
					18x20	0.042	0.083	1990	16x32	0.042	0.085	2680						
									18x25	0.042	0.085	2690						
1000	13x25	0.030	0.060	1960	13x40	0.029	0.058	2510	16x36	0.035	0.071	2780						
					16x26	0.034	0.068	2250										
1200	13x30	0.024	0.050	2320	16x32	0.027	0.055	2710	16x36	0.030	0.060	2860						
	16x22	0.028	0.057	2220	18x25	0.028	0.057	2610	18x32	0.032	0.064	2960						
1500	13x35	0.022	0.043	2520	16x36	0.025	0.050	2810	18x35	0.030	0.060	3120						
1800	13x40	0.016	0.034	2880	16x40	0.020	0.042	3210										
	16x26	0.022	0.044	2570					18x40	0.025	0.050	3220						
	18x20	0.027	0.055	2510	18x32	0.025	0.050	3010										
2200	16x32	0.018	0.038	3020														
	18x25	0.020	0.040	2750	18x35	0.022	0.045	3110										
2700	16x36	0.017	0.033	3160														
	18x32	0.018	0.036	3340	18x40	0.020	0.040	3410										
3300	16x40	0.015	0.030	3720														
	18x35	0.016	0.031	3690														
3900	18x40	0.015	0.030	3810														

※ 13mm may be replaced by 12.5mm upon customer's request.

SG series

- High ripple current, ultra low impedance at high frequency range.
- Long life.
- RoHS Compliance
- 高紋波電流、高頻超低阻抗。
- 長壽命產品。



SPECIFICATIONS

Items 項目	Characteristics 特性						
Capacitance Tolerance 靜電容量誤差	± 20%(120Hz,20°C)						
Operating Temperature Range 適用溫度範圍	-40 ~ +105°C						
Rated Voltage Range 額定電壓範圍	6.3 ~ 50VDC						
Leakage Current 洩漏電流	I ≤ 0.01CV or 3 (µA) which is greater. (After 2 minutes application of DC rated voltage, at 20 °C)						
Dissipation Factor 散逸因素(tan δ)	Measurement Frequency: 120Hz. Temperature: 20°C						
	Rated Voltage(V)	6.3	10	16	25	35	50
	tan δ(Max)	0.15	0.12	0.10	0.09	0.08	0.07
	When nominal capacitance over 1000µF, tanδ shall be added 0.02 to the listed value with increase of every 1000µF.						
Low Temperature Stability 低溫特性 Impedance Ratio(Max) 阻抗比率(最大值)	Measurement Frequency: 120Hz.						
	Rated Voltage(V)	6.3	10	16	25	35	50
	Z(-25°C)/Z(20°C)	2	2	2	2	2	2
	Z(-40°C)/Z(20°C)	3	3	3	3	3	3
Load Life 負荷壽命	The following specifications shall be satisfied when the capacitors are restored to 20°C after subjected to DC voltage with the rated ripple current is applied for 5,000 hours (ϕ D≤6.3:2,000 hours; ϕ D=8:3,000 hours; ϕ D=10:4,000 hours) at 105°C.						
	Capacitance Change	Within ± 25% of Initial Value					
	tan δ	200% or less of Initial Specified Value					
	Leakage Current	Initial Specified Value or less					
Shelf Life 放置壽命	The following specifications shall be satisfied when the capacitors are restored to 20°C after exposing them for 1,000 hours 105°C without voltage applied. Before the measurement, the capacitor shall be preconditioned by applying voltage according to them 4.1 of JIS C5101-4.						
	Capacitance Change	Within ± 20% of Initial Value					
	tan δ	200% or less of Initial Specified Value					
	Leakage Current	Initial Specified Value or less					
Standards 參照標準	JIS C 5101-4 (IEC 60384)						

SG

Frequency Coefficient of Permissible Ripple Current

Capacitance (µF)	Frequency (Hz)				
	50	120	1K	10K	100K
≤ 33	0.45	0.55	0.75	0.90	1.00
47 ~ 330	0.60	0.70	0.85	0.95	1.00
470 ~ 1000	0.65	0.75	0.90	0.98	1.00
1200 ~ 6800	0.75	0.80	0.95	1.00	1.00

The endurance of capacitors is reduced with internal heating produced by ripple current at the rate of halving the lifetime with every 5°C rise. When long life performance is required in actual use , the rms ripple current has to be reduced.

SG series

DIMENSIONS(mm)

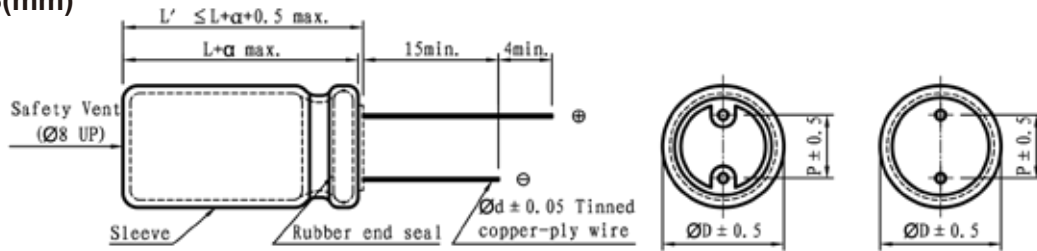

ϕD	5	6.3	8	10	13	16
P	2.0	2.5	3.5	5.0	5.0	7.5
ϕd	0.5	0.5	0.5	0.6	0.6	0.8

STANDARD RATINGS

D×L(mm) ; R.C.(mA rms) at 105°C 100KHz ; IMP (Ω max)at 20°C 100KHz.

Cap (μF)	V	6.3			10			16		
		Item	D x L	R.C.	IMP	D x L	R.C.	IMP	D x L	R.C.
56								5x11	250	0.300
100					5x11	250	0.300			
120								6.3x11	405	0.130
150		5x11	250	0.300						
220					6.3x11	405	0.130			
330		6.3x11	405	0.130	8x12	600	0.085	8x12	760	0.072
470					8x12	760	0.072	8x16	995	0.056
560		8x12	760	0.072				10x13	1030	0.053
680					8x16	995	0.056	8x20	1250	0.041
820		8x16	995	0.056	10x13	1030	0.053	10x16	1430	0.038
1000		10x13	1030	0.053	8x20	1250	0.041			
1200		10x16	1430	0.038	10x16	1430	0.038	10x20	1820	0.023
1500		8x20	1250	0.041	10x20	1820	0.023	10x25	2150	0.022
2200		10x20	1820	0.023	10x25	2150	0.022	13x21	2360	0.021
2700		10x25	2150	0.022	13x21	2360	0.021	13x25	2770	0.018
3300								13x30	3140	0.016
3900		13x21	2360	0.021	13x25	2770	0.018	16x22	3290	0.018
4700		13x25	2770	0.018	13x30	3290	0.016	13x35	3400	0.015
5600		13x30	3290	0.016	16x22	3140	0.018			
6800		13x35	3350	0.015	13x35	3400	0.015			
		16x22	3400	0.018	16x26	3460	0.016			
		16x26	3460	0.016						

Cap (μF)	V	25			35			50		
		Item	D x L	R.C.	IMP	D x L	R.C.	IMP	D x L	R.C.
22								5x11	238	0.340
33					5x11	250	0.300			
47		5x11	250	0.300						
56					6.3x11	405	0.130	6.3x11	385	0.140
68										
100		6.3x11	405	0.130				8x12	724	0.074
120								8x16	950	0.061
150					8x12	760	0.072	10x13	979	0.061
180								8x20	1190	0.046
220		8x12	760	0.072	8x16	995	0.056	10x16	1370	0.042
270					10x13	1030	0.053	10x20	1580	0.030
330		8x16	995	0.056	8x20	1250	0.041			
		10x13	1030	0.053	10x16	1430	0.038	10x25	1870	0.028
470		10x16	1430	0.038	10x20	1820	0.023	13x21	2050	0.027
560		8x20	1250	0.041	10x25	2150	0.022	13x25	2410	0.023
680		10x20	1820	0.023	13x21	2360	0.021	13x30	2860	0.021
820		10x25	2150	0.022	13x21	2450	0.020	13x35	2960	0.019
1000		13x21	2360	0.021	13x25	2770	0.018	16x22	2730	0.023
1200		13x21	2360	0.021	13x30	3140	0.016	16x26	3010	0.021
1500		13x25	2770	0.018	16x22	3290	0.018			
1800		13x30	3140	0.016	13x35	3400	0.015			
2200		16x22	3290	0.018	16x26	3460	0.016			
2700		13x35	3400	0.015						
		16x26	3460	0.016						

※ 13mm may be replaced by 12.5mm upon customer's request.

SX series

- 105°C High ripple and Low impedance, long life : 4,000~5,000 hours.
- Suited for LCD TV BLU Inverter, SMPS, IP-Board, Adaptor, etc.
- 105°C高紋波低阻抗品，壽命：4,000~5,000 hours。
- 適用背光模組轉換器、開關電源、適配器等。

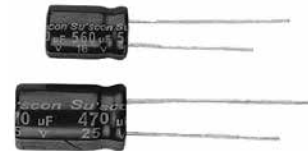

SPECIFICATIONS

Items 項目	Characteristics 特性					
Capacitance Tolerance 靜電容量誤差	± 20%(120Hz,20°C)					
Operating Temperature Range 適用溫度範圍	-40 ~ +105°C					
Rated Voltage Range 額定電壓範圍	10 ~ 50VDC					
Leakage Current 洩漏電流	I ≤ 0.01CV or 3 (µA) which is greater. (After 2 minutes application of DC rated voltage, at 20 °C)					
Dissipation Factor 散逸因素(tan δ)	Measurement Frequency: 120Hz. Temperature: 20°C					
	Rated Voltage(V)	10	16	25	35	50
	tan δ(Max)	0.19	0.16	0.14	0.12	0.10
When nominal capacitance over 1000µF, tanδ shall be added 0.02 to the listed value with increase of every 1000µF.						
Low Temperature Stability 低溫特性 Impedance Ratio(Max) 阻抗比率(最大值)	Measurement Frequency: 120Hz.					
	Rated Voltage(V)	10	16	25	35	50
	Z(-25°C)/Z(20°C)	2	2	2	2	2
	Z(-40°C)/Z(20°C)	3	3	3	3	3
Load Life 負荷壽命	The following specifications shall be satisfied when the capacitors are restored to 20°C after subjected to DC voltage with the rated ripple current is applied for 5,000 hours (ϕ D≤8 & Size:10x13; 4,000 hours) at 105°C.					
	Capacitance Change	Within ± 30% of Initial Value				
	tan δ	200% or less of Initial Specified Value				
	Leakage Current	Initial Specified Value or less				
Shelf Life 放置壽命	The following specifications shall be satisfied when the capacitors are restored to 20°C after exposing them for 1,000 hours 105°C without voltage applied. Before the measurement, the capacitor shall be preconditioned by applying voltage according to them 4.1 of JIS C5101-4.					
	Capacitance Change	Within ± 25% of Initial Value				
	tan δ	200% or less of Initial Specified Value				
	Leakage Current	Initial Specified Value or less				
Standards 參照標準	JIS C 5101-4-1 (IEC 60384)					

SX

Frequency Coefficient of Permissible Ripple Current

Capacitance (µF)	Frequency (Hz)			
	120	1K	10K	100K
100 ~ 270	0.40	0.75	0.90	1.00
330 ~ 680	0.50	0.85	0.94	1.00
820 ~ 1800	0.60	0.87	0.95	1.00
2200 ~ 2700	0.75	0.90	0.95	1.00

The endurance of capacitors is reduced with internal heating produced by ripple current at the rate of halving the lifetime with every 5°C rise. When long life performance is required in actual use , the rms ripple current has to be reduced.

SX series

DIMENSIONS(mm)

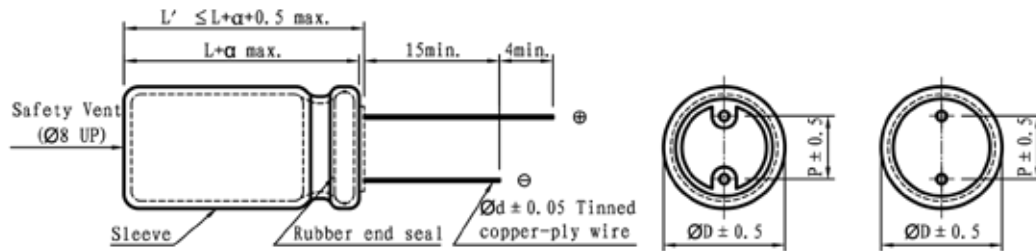

ϕD	8	10
P	3.5	5
ϕd	0.5	0.6

α	(L < 16) 1.0 (L ≥ 16) 2.0
----------	------------------------------

STANDARD RATINGS

D×L(mm) ; R.C.(mA rms) at 105°C 100KHz ; IMP (Ω max)at 20°C 100KHz.

Cap (μF)	V	10			16			25		
		Item	D x L	R.C.	IMP	D x L	R.C.	IMP	D x L	R.C.
330								8x12	1420	0.072
390								8x16	2045	0.056
470					8x12	1420	0.072	10x13	2180	0.052
560								8x20	2385	0.040
680		8x12	1420	0.072	8x12	2045	0.056	10x16	2540	0.037
					10x13	2180	0.052			
820								10x20	2870	0.027
1000		8x16	2045	0.056	8x20	2385	0.040	10x25	3165	0.023
		10x13	2180	0.052	10x16	2540	0.037			
1200								10x35	3580	0.020
1500		8x20	2385	0.040	10x20	2870	0.027			
		10x16	2540	0.037						
1800		10x20	2870	0.027	10x25	3165	0.023			
2200		10x25	3165	0.023	10x35	3580	0.020			
2700		10x35	3580	0.020						

Cap (μF)	V	35			50		
		Item	D x L	R.C.	IMP	D x L	R.C.
100					8x12	1090	0.095
120					8x16	1560	0.078
150					10x13	1620	0.087
180					8x20	1900	0.064
220		8x12	1420	0.072	10x16	1990	0.056
270		8x16	2045	0.056	10x20	2330	0.041
330		10x13	2180	0.052	10x25	2630	0.036
390		8x20	2385	0.040			
470		10x16	2540	0.037	10x35	2960	0.032
560		10x20	2870	0.027			
680		10x25	3165	0.023			
820							
1000		10x35	3580	0.020			

※ 13mm may be replaced by 12.5mm upon customer's request.

XS

MG series

- Low impedance at high frequency range.
- Smaller case size and high ripple current.
- RoHS Compliance.
- 高頻超低阻抗。
- 小尺寸高紋波電流。



SPECIFICATIONS

Items 項目	Characteristics 特性						
Capacitance Tolerance 靜電容量誤差	± 20%(120Hz,20°C)						
Operating Temperature Range 適用溫度範圍	-40 ~ +105°C						
Rated Voltage Range 額定電壓範圍	6.3 ~ 35VDC						
Leakage Current 洩漏電流	I ≤ 0.01CV or 3(μA) which is greater.(After 2 minutes application of DC rated voltage, at 20°C)						
Dissipation Factor 散逸因素(tan δ)	Measurement Frequency: 120Hz. Temperature: 20°C						
	Rated Voltage(V)	6.3	10	16	25	35	
	tan δ(Max)	0.21	0.18	0.15	0.13	0.11	
When nominal capacitance over 1000μF, tanδ shall be added 0.02 to the listed value with increase of every 1000μF.							
Low Temperature Stability 低溫特性	Measurement Frequency: 120Hz.						
	Rated Voltage(V)	6.3	10	16	25	35	
	Impedance Ratio(Max) 阻抗比率(最大值)	Z(-25°C)/Z(20°C)	2	2	2	2	2
	Z(-40°C)/Z(20°C)	3	3	3	3	3	
Load Life 負荷壽命	The following specifications shall be satisfied when the capacitors are restored to 20°C after subjected to DC voltage with the rated ripple current is applied for 6,000 hours (φ D≤6.3:5,000 hours) at 105°C.						
	Capacitance Change	Within ± 25% of Initial Value					
	tan δ	200% or less of Initial Specified Value					
	Leakage Current	Initial Specified Value or less					
Shelf Life 放置壽命	The following specifications shall be satisfied when the capacitors are restored to 20°C after exposing them for 1,000 hours 105°C without voltage applied. Before the measurement, the capacitor shall be preconditioned by applying voltage according to them 4.1 of JIS C5101-4.						
	Capacitance Change	Within ± 20% of Initial Value					
	tan δ	200% or less of Initial Specified Value					
	Leakage Current	Initial Specified Value or less					
Standards 參照標準	JIS C 5101-4 (IEC 60384)						

MG

Frequency Coefficient of Permissible Ripple Current

Capacitance (μF)	Frequency (Hz)			
	120	1K	10K	100K
47 ~ 150	0.40	0.75	0.90	1.00
220 ~ 560	0.50	0.85	0.94	1.00
680 ~ 1800	0.60	0.87	0.95	1.00
2200 ~ 3900	0.75	0.90	0.95	1.00
4700 ~ 8200	0.85	0.95	0.98	1.00

The endurance of capacitors is reduced with internal heating produced by ripple current at the rate of halving the lifetime with every 5°C rise. When long life performance is required in actual use , the rms ripple current has to be reduced.

MG series

DIMENSIONS(mm)

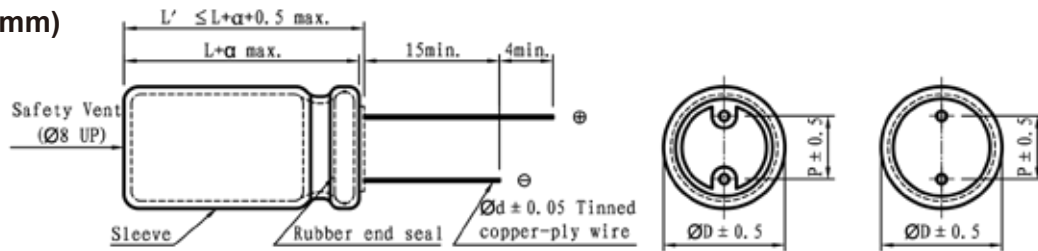

ϕD	5	6.3	8	10	13	16
P	2.0	2.5	3.5	5.0	5.0	7.5
ϕd	0.5	0.5	0.5	0.6	0.6	0.8

α	(L < 16) 1.0
	(L \geq 16) 2.0

STANDARD RATINGS

D×L(mm) ; R.C.(mA rms) at 105°C 100KHz ; IMP (Ω max)at 20°C,-10°C 100KHz.

Cap (μF)	V	6.3				10				16				
		Item	D x L	IMP		R.C.	D x L	IMP		R.C.	D x L	IMP		R.C.
				20°C	-10°C			20°C	-10°C			20°C	-10°C	
100										5x11	0.230	0.760	360	
150						5x11	0.230	0.760	360	6.3x11	0.100	0.330	450	
220		5x11	0.230	0.760	360	6.3x11	0.100	0.330	450	6.3x11	0.100	0.330	550	
330		6.3x11	0.100	0.330	460	6.3x11	0.100	0.330	550	8x12	0.059	0.181	830	
470		6.3x11	0.100	0.330	550	8x12	0.059	0.181	820	8x12	0.059	0.181	990	
680		8x12	0.059	0.181	900	8x12	0.059	0.181	990	8x16	0.046	0.143	1330	
820		8x12	0.059	0.181	990	10x13	0.043	0.133	1250	10x16	0.030	0.095	1650	
1000		10x13	0.043	0.133	1250	8x16	0.046	0.143	1330	8x20	0.031	0.105	1550	
1200		10x13	0.043	0.133	1360	10x13	0.043	0.133	1360	10x16	0.030	0.095	1815	
1500		8x16	0.046	0.143	1300	10x16	0.030	0.095	1650	10x20	0.019	0.057	1930	
1800		10x16	0.030	0.095	1550	8x20	0.031	0.105	1550	10x20	0.019	0.057	2160	
2200		10x16	0.030	0.095	1815	10x16	0.030	0.095	1815	10x25	0.017	0.051	2475	
2700		10x20	0.019	0.057	2160	10x20	0.019	0.057	2160	10x25	0.017	0.051	2475	
3300		10x25	0.017	0.051	2475	13x21	0.016	0.041	2475	13x21	0.016	0.041	2725	
3900		13x21	0.016	0.041	2500	13x21	0.016	0.041	2725	13x21	0.016	0.041	2725	
4700		13x21	0.016	0.041	2725	13x25	0.014	0.036	3190	13x25	0.014	0.036	3190	
5600		13x25	0.014	0.036	3190	13x30	0.012	0.031	3795	13x30	0.012	0.031	3795	
6800		13x30	0.012	0.031	3795	16x22	0.014	0.036	3575	16x22	0.014	0.036	3575	
8200		16x22	0.014	0.036	3575	16x26	0.012	0.033	3990	16x26	0.012	0.033	3990	
8200		16x26	0.012	0.033	3990									

Cap (μF)	V	25				35				
		Item	D x L	IMP		R.C.	D x L	IMP		R.C.
				20°C	-10°C			20°C	-10°C	
47						5x11	0.230	0.760	360	
68		5x11	0.230	0.760	360	6.3x11	0.100	0.330	450	
100		6.3x11	0.100	0.330	450	6.3x11	0.100	0.330	550	
150		8x12	0.085	0.260	620	8x12	0.059	0.181	820	
220		8x12	0.059	0.181	810	8x12	0.059	0.181	990	
270		8x12	0.059	0.181	900	8x16	0.046	0.143	1330	
330		8x12	0.059	0.181	990	10x13	0.043	0.133	1360	
390		8x16	0.046	0.143	1330	8x20	0.031	0.105	1550	
470		10x13	0.043	0.133	1360	10x16	0.030	0.095	1815	
560		8x20	0.032	0.110	1550	10x20	0.030	0.095	2160	
680		10x16	0.031	0.100	1815	10x25	0.027	0.080	2475	
820		10x20	0.020	0.062	2160	13x21	0.022	0.065	2725	
1000		10x25	0.018	0.055	2475	13x21	0.019	0.053	2920	
1200		13x21	0.017	0.049	2650	13x25	0.015	0.043	3190	
1500		13x21	0.023	0.059	2725	13x30	0.013	0.040	3795	
1800		13x25	0.020	0.051	3190	16x22	0.014	0.036	3575	
2200		13x30	0.018	0.046	3795	13x35	0.011	0.029	3925	
2700		16x22	0.014	0.036	3575	16x26	0.012	0.033	3990	
3300		13x35	0.015	0.029	3925					
3300		16x26	0.012	0.033	3990					

※ 13mm may be replaced by 12.5mm upon customer's request.

MG

HG series

- High ripple current, low impedance at high frequency range.
- 105°C 10000 hours long life .
- RoHS Compliance
- 高紋波電流、高頻低阻抗。
- 105°C 10000小時長壽命產品。

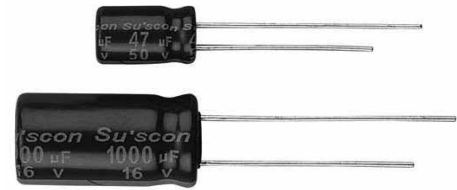

SPECIFICATIONS

Items 項目	Characteristics 特性										
Capacitance Tolerance 靜電容量誤差	± 20%(120Hz,20°C)										
Operating Temperature Range 適用溫度範圍	-40 ~ +105°C										
Rated Voltage Range 額定電壓範圍	6.3 ~ 100VDC										
Leakage Current 洩漏電流	I ≤ 0.01CV or 3 (μA) which is greater.(After 2 minutes application of DC rated voltage, at 20 °C)										
Dissipation Factor 散逸因素(tan δ)	Measurement Frequency: 120Hz. Temperature: 20°C										
	Rated Voltage(V)	6.3	10	16	25	35	50	63~80	100		
	tan δ (Max)	0.22	0.19	0.16	0.14	0.12	0.10	0.09	0.08		
When nominal capacitance over 1000μF, tanδ shall be added 0.02 to the listed value with increase of every 1000μF.											
Low Temperature Stability 低溫特性 Impedance Ratio(Max) 阻抗比率(最大值)	Measurement Frequency: 120Hz.										
	Rated Voltage(V)	6.3	10	16	25	35	50	63~80	100		
	Z(-25°C)/Z(20°C)	4	3	2	2	2	2	2	2		
Z(-40°C)/Z(20°C)											
Load Life 負荷壽命	The following specifications shall be satisfied when the capacitors are restored to 20°C after subjected to DC voltage with the rated ripple current is applied for varied hours according to varied ϕ and voltage [please refer to below sheet] at 105°C.										
	Case Size	ϕ D ≤ 6.3			ϕ D = 8, 10			ϕ D ≥ 13			
	Rated Voltage(V)	6.3~10 V		4,000hours		6,000hours		8,000hours			
		16~100 V		5,000hours		7,000hours		10,000hours			
	Capacitance Change	Within ± 25% of Initial Value									
	tan δ	200% or less of Initial Specified Value									
Leakage Current	Initial Specified Value or less										
Shelf Life 放置壽命	The following specifications shall be satisfied when the capacitors are restored to 20°C after exposing them for 1,000 hours 105°C without voltage applied. Before the measurement, the capacitor shall be preconditioned by applying voltage according to them 4.1 of JIS C5101-4.										
	Capacitance Change	Within ± 20% of Initial Value									
	tan δ	200% or less of Initial Specified Value									
	Leakage Current	Initial Specified Value or less									
Standards 參照標準	JIS C 5101-4 (IEC 60384)										

HG

Frequency Coefficient of Permissible Ripple Current

Capacitance (μF)	Frequency (Hz)				
	50	120	300	1K	100K
≤ 33	0.50	0.55	0.70	0.90	1.00
47 ~ 330	0.60	0.70	0.85	0.95	1.00
470 ~ 1000	0.65	0.75	0.90	0.98	1.00
1200 ~ 18000	0.70	0.80	0.95	1.00	1.00

The endurance of capacitors is reduced with internal heating produced by ripple current at the rate of halving the lifetime with every 5°C rise. When long life performance is required in actual use , the rms ripple current has to be reduced.

HG series

DIMENSIONS(mm)

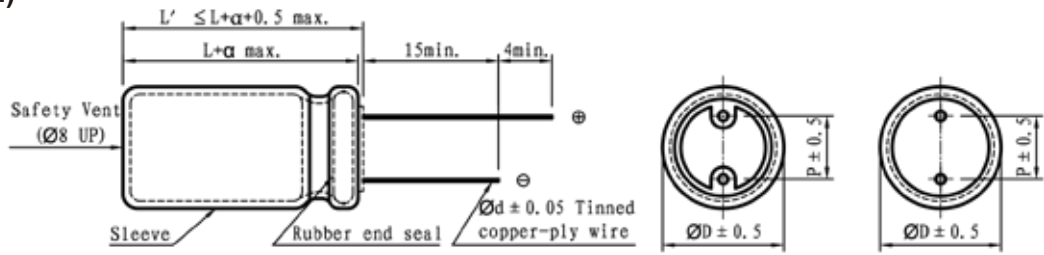

ϕD	5	6.3	8	10	13	16	18
P	2.0	2.5	3.5	5.0	5.0	7.5	7.5
ϕd	0.5	0.5	0.5	0.6	0.6	0.8	0.8

STANDARD RATINGS

DxL(mm) ; R.C.(mA rms) at 105°C 100KHz ; IMP (Ω max)at 20°C,-10°C 100KHz.

Cap (μ F)	V Item	6.3				10			
		D x L	IMP		R.C.	D x L	IMP		R.C.
			20°C	-10°C			20°C	-10°C	
100					5x11	0.580	2.300	215	
150		5x11	0.570	2.300	210	5x11	0.580	2.300	230
220		6.3x11	0.250	0.900	320	6.3x11	0.220	0.870	340
330		6.3x11	0.210	0.870	340	6.3x11	0.220	0.870	380
470		8x12	0.150	0.580	520	8x12	0.130	0.520	640
680		8x12	0.130	0.520	645	8x16	0.086	0.350	845
						10x13	0.080	0.310	865
820		10x13	0.080	0.320	865	10x16	0.070	0.280	1015
1000		8x16	0.085	0.350	870	8x20	0.068	0.270	1050
						10x16	0.060	0.240	1215
1200		8x20	0.071	0.260	1050	10x20	0.045	0.180	1410
		10x16	0.062	0.240	1215				
1500		10x20	0.045	0.180	1410	10x25	0.041	0.170	1610
1800		13x16	0.048	0.160	1460	13x16	0.049	0.160	1450
						13x21	0.039	0.150	1710
2200		10x25	0.042	0.170	1650	10x30	0.030	0.120	1920
						13x21	0.035	0.120	1910
						16x15	0.042	0.120	1900
2700		10x30	0.030	0.120	1900	18x15	0.042	0.110	2220
		16x15	0.041	0.120	1945				
3300		13x21	0.034	0.120	1900	13x25	0.026	0.089	2230
3900		13x25	0.026	0.088	2240	13x30	0.023	0.078	2660
		18x15	0.042	0.110	2210	16x22	0.026	0.078	2540
4700		13x30	0.023	0.078	2650	13x35	0.020	0.065	2890
5600		13x35	0.020	0.065	2890	13x40	0.016	0.055	3360
						16x26	0.020	0.060	2940
						18x20	0.025	0.066	2870
6800		13x40	0.016	0.055	3350	16x32	0.016	0.050	3460
		16x26	0.020	0.060	2940				
		18x20	0.025	0.066	2870				
8200		16x32	0.016	0.050	3450	16x36	0.015	0.044	3610
						18x32	0.015	0.040	4180
10000		16x36	0.014	0.044	3620	16x40	0.013	0.038	4090
		18x25	0.018	0.049	3150	18x35	0.012	0.038	4230
12000		16x40	0.012	0.038	4090	18x40	0.011	0.032	4290
		18x32	0.014	0.040	4180				
15000		18x35	0.013	0.038	4230				
18000		18x40	0.012	0.032	4290				

※ 13mm may be replaced by 12.5mm upon customer's request.

HG series

STANDARD RATINGS

D×L(mm) ; R.C.(mA rms) at 105°C 100KHz ; IMP (Ω max)at 20°C,-10°C 100KHz.

Cap (μF)	V Item	16			25				
		D x L	IMP		R.C.	D x L	IMP		
			20°C	-10°C			20°C	-10°C	
47					5x11	0.570	2.300	200	
56		5x11	0.570	2.300	220	5x11	0.570	2.300	240
100		6.3x11	0.210	0.820	310	6.3x11	0.210	0.870	340
120		6.3x11	0.210	0.870	340				
220		8x12	0.190	0.850	510	8x12	0.120	0.520	650
330		8x12	0.120	0.520	650	8x16	0.087	0.350	850
						10x13	0.081	0.320	870
470		8x16	0.086	0.350	840	8x20	0.070	0.270	1050
		10x13	0.080	0.320	865	10x16	0.060	0.240	1210
680		8x20	0.069	0.270	1060	10x20	0.045	0.180	1410
		10x16	0.060	0.240	1210	13x16	0.049	0.160	1460
820		10x20	0.052	0.220	1310	10x25	0.041	0.170	1660
1000		10x20	0.045	0.180	1410	10x30	0.030	0.120	1920
						13x21	0.034	0.120	1910
						16x15	0.042	0.120	1940
1200		10x25	0.043	0.170	1650	18x15	0.043	0.110	2220
1500		10x30	0.030	0.120	1920	13x25	0.026	0.089	2240
		13x21	0.035	0.120	1910				
		16x15	0.042	0.120	1940				
1800		13x25	0.028	0.095	2140	13x30	0.024	0.078	2660
						16x22	0.026	0.078	2540
2200		13x25	0.026	0.089	2240	13x35	0.020	0.065	2890
		18x15	0.042	0.110	2220	18x20	0.025	0.066	2870
2700		13x30	0.023	0.077	2650	13x40	0.016	0.056	3360
		16x22	0.026	0.078	2540	16x26	0.021	0.060	2940
3300		13x35	0.020	0.066	2890	16x32	0.016	0.050	3460
						18x25	0.018	0.048	3150
3900		13x40	0.016	0.056	3350	16x36	0.014	0.043	3620
		16x26	0.021	0.060	2930				
		16x22	0.025	0.067	2860				
4700		16x32	0.016	0.050	3450	16x40	0.014	0.044	4080
		18x25	0.018	0.049	3150	18x35	0.013	0.040	4230
5600		16x36	0.015	0.044	3620	18x40	0.011	0.032	4290
		18x32	0.015	0.040	4180				
6800		16x40	0.012	0.038	4080				
8200		18x35	0.014	0.038	4230				
10000		18x40	0.011	0.032	4290				

※ 13mm may be replaced by 12.5mm upon customer's request.

HG

HG series

STANDARD RATINGS

D×L(mm) ; R.C.(mA rms) at 105°C 100KHz ; IMP (Ω max)at 20°C,-10°C 100KHz.

Cap (μF)	V	35				50				
		Item	D x L	IMP		R.C.	D x L	IMP		R.C.
				20°C	-10°C			20°C	-10°C	
22						5x11	0.700	2.800	180	
33		5x11	0.560	2.300	220					
47		6.3x11	0.350	1.400	280	6.3x11	0.380	1.500	220	
56		6.3x11	0.210	0.860	340	6.3x11	0.300	1.200	300	
100		8x12	0.150	0.560	510	8x12	0.160	0.670	560	
120						8x16	0.120	0.480	740	
150		8x12	0.130	0.520	650	10x13	0.120	0.480	770	
180		8x16	0.086	0.350	800	8x20	0.090	0.360	920	
220		8x16	0.086	0.350	850	10x16	0.083	0.340	1050	
		10x13	0.080	0.320	865					
270		8x20	0.070	0.260	1060	10x20	0.060	0.240	1230	
						13x16	0.062	0.200	1250	
330		10x16	0.060	0.240	1210	10x25	0.053	0.220	1450	
470		10x20	0.045	0.180	1410	10x30	0.043	0.170	1695	
		13x16	0.048	0.150	1460	13x21	0.044	0.150	1670	
						16x15	0.054	0.170	1695	
560		10x25	0.041	0.160	1650	13x25	0.033	0.110	1950	
						18x15	0.053	0.150	1940	
						10x30	0.030	0.120	1920	
680		13x21	0.033	0.132	1910	13x30	0.030	0.100	2320	
		16x15	0.041	0.143	1950					
		10x30	0.030	0.120	1920					
820		13x25	0.028	0.088	2100	13x35	0.023	0.081	2520	
						16x22	0.033	0.100	2220	
						13x40	0.020	0.069	2930	
1000		13x25	0.028	0.088	2230	16x26	0.025	0.075	2555	
						18x20	0.036	0.097	2490	
						13x30	0.023	0.078	2660	
1200		16x22	0.026	0.078	2530	16x32	0.021	0.066	3020	
		18x25	0.025	0.070	2750					
1500		13x35	0.020	0.065	2880	16x36	0.018	0.056	3150	
1800		13x40	0.016	0.056	3350	16x40	0.016	0.048	3720	
		16x26	0.020	0.060	2940					
		18x20	0.025	0.066	2870					
2200		18x32	0.021	0.057	3640	18x35	0.017	0.046	3690	
		16x32	0.016	0.050	3500					
2700		18x25	0.019	0.049	3140	18x40	0.014	0.038	3810	
		16x36	0.015	0.044	3620					
		18x32	0.014	0.040	4180					
3300		16x40	0.013	0.038	4090					
		18x35	0.014	0.040	4230					
3900		18x40	0.012	0.033	4290					

※ 13mm may be replaced by 12.5mm upon customer's request.

HG

HG series

STANDARD RATINGS

D×L(mm) ; R.C.(mA rms) at 105°C 100KHz ; IMP (Ω max)at 20°C, -10°C 100KHz.

Cap (μF)	V	63				100				
		Item	D x L	IMP		R.C.	D x L	IMP		R.C
				20°C	-10°C			20°C	-10°C	
6.8						5x11	2.200	9.200	56	
15		5x11	2.200	9.200	56	6.3x11	1.200	5.000	120	
27						8x12	0.72	3.000	235	
33		6.3x11	1.200	5.000	120					
39						8x16	0.62	2.540	280	
47		8x12	0.680	3.100	190	10x13	0.430	1.800	290	
56		8x12	0.620	2.800	235	8x20	0.320	1.600	340	
68						10x16	0.300	1.500	358	
82		8x16	0.450	2.100	310	10x20	0.210	0.940	470	
		10x13	0.430	1.800	300	13x16	0.230	1.100	468	
100		10x16	0.350	1.800	320	10x25	0.200	0.840	536	
120		8x20	0.330	1.600	362	10x30	0.150	0.710	666	
		10x16	0.300	1.500	357	13x21	0.160	0.640	690	
150						16x15	0.140	0.660	795	
180		10x20	0.200	0.940	470	13x25	0.120	0.450	790	
		13x16	0.230	1.100	465	18x15	0.120	0.500	930	
220		10x25	0.200	0.840	531	13x30	0.110	0.450	905	
						16x22	0.090	0.370	1050	
270		10x30	0.150	0.700	663	13x35	0.082	0.350	1060	
		13x21	0.160	0.640	690	16x26	0.072	0.270	1250	
		16x15	0.130	0.650	795					
330		13x25	0.120	0.450	790	13x40	0.070	0.300	1190	
						18x20	0.080	0.300	1250	
390		18x15	0.120	0.500	920	16x32	0.053	0.200	1570	
						18x25	0.056	0.210	1490	
470		13x30	0.100	0.420	910	16x36	0.045	0.170	1790	
		16x22	0.090	0.380	1040	18x32	0.047	0.170	1640	
560		13x35	0.082	0.350	1050	16x40	0.040	0.150	2030	
		16x26	0.073	0.270	1250					
680		13x40	0.070	0.300	1190	18x35	0.040	0.150	1790	
		18x20	0.080	0.300	1240					
820		16x32	0.053	0.200	1580	18x40	0.036	0.130	2340	
		18x25	0.057	0.210	1490					
1000		16x36	0.045	0.170	1790					
		18x32	0.047	0.170	1640					
1200		16x40	0.039	0.150	2020					
		18x35	0.040	0.150	1790					
1500		18x40	0.035	0.130	2340					

※ 13mm may be replaced by 12.5mm upon customer's request.

HG

HX series

- 105°C High ripple and Low impedance, long life: 6,000~10,000 hours.
- Suited for LCD TV BLU Inverter, SMPS, IP-Board, Adaptor etc..
- 105°C高紋波, 低阻抗品, 壽命: 6,000~10,000 hours。
- 適用背光模組轉換器、開關電源、適配器等。



SPECIFICATIONS

Items 項目	Characteristics 特性									
Capacitance Tolerance 靜電容量誤差	± 20%(120Hz, 20°C)									
Operating Temperature Range 適用溫度範圍	-40 ~ +105°C									
Rated Voltage Range 額定電壓範圍	6.3 ~ 100VDC									
Leakage Current 洩漏電流	I ≤ 0.01CV or 3 (µA) which is greater. (After 2 minutes application of DC rated voltage, at 20 °C)									
Dissipation Factor 散逸因素(tan δ)	Measurement Frequency: 120Hz. Temperature: 20°C									
	Rated Voltage(V)	6.3	10	16	25	35	50	63	80	100
	tan δ (Max)	0.22	0.19	0.16	0.14	0.12	0.1	0.09	0.08	0.08
When nominal capacitance over 1000µF, tanδ shall be added 0.02 to the listed value with increase of every 1000µF.										
Low Temperature Stability 低溫特性 Impedance Ratio(Max) 阻抗比率(最大值)	Measurement Frequency: 120Hz.									
	Rated Voltage(V)	6.3	10	16	25	35	50	63	80	100
	Z(-25°C)/Z(20°C)	2	2	2	2	2	2	2	2	2
	Z(-40°C)/Z(20°C)	3	3	3	3	3	3	3	3	3
Load Life 負荷壽命	The following specifications shall be satisfied when the capacitors are restored to 20°C after subjected to DC voltage with the rated ripple current is applied for varied hours according to varied ϕ and voltage [please refer to below sheet] at 105°C.									
	Case Size(ϕ D)	Life time								
		6.3V	10 ~ 50V	63 ~ 100V						
	ϕ 5 ~ ϕ 6.3	6,000hours	7,000hours	6,000hours						
	ϕ 8 x12L	8,000hours	9,000hours	8,000hours						
	ϕ 8x16L ~ 20L	9,000hours	10,000hours	9,000hours						
	ϕ 10x13L	9,000hours								
	ϕ 10x16L ~ 25L	10,000hours								
	> ϕ 10	10,000hours								
	Rated Voltage(V)	6.3~10 V					16~100 V			
Capacitance Change	Within ± 30% of Initial Value					Within ± 25% of Initial Value				
tan δ	200% or less of Initial Specified Value									
Leakage Current	Initial Specified Value or less									
Shelf Life 放置壽命	The following specifications shall be satisfied when the capacitors are restored to 20°C after exposing them for 1,000 hours 105°C without voltage applied. Before the measurement, the capacitor shall be preconditioned by applying voltage according to them 4.1 of JIS C5101-4.									
	Capacitance Change	Within ± 20% of Initial Value								
	tan δ	200% or less of Initial Specified Value								
	Leakage Current	Initial Specified Value or less								
Standards 參照標準	JIS C 5101-4-1 (IEC 60384)									

Frequency Coefficient of Permissible Ripple Current

Capacitance (µF)	Frequency (Hz)			
	120	1K	10K	100K
5.6 ~ 180	0.40	0.70	0.90	1.00
220 ~ 560	0.50	0.85	0.94	1.00
680 ~ 1800	0.60	0.87	0.95	1.00
2200 ~ 3900	0.75	0.90	0.95	1.00
4700 ~ 18000	0.85	0.95	0.98	1.00

The endurance of capacitors is reduced with internal heating produced by ripple current at the rate of halving the lifetime with every 5°C rise. When long life performance is required in actual use , the rms ripple current has to be reduced.

HX series

DIMENSIONS(mm)

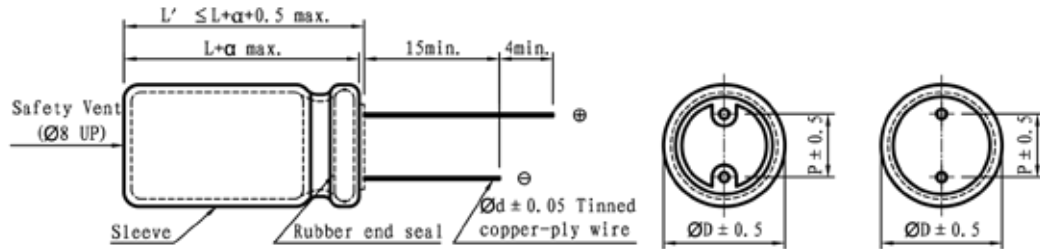

ϕD	5	6.3	8	10	13	16	18
P	2	2.5	3.5	5	5	7.5	7.5
ϕd	0.5	0.5	0.5	0.6	0.6	0.8	0.8

α	(L < 16) 1.0
	(L ≥ 16) 2.0

STANDARD RATINGS

D×L(mm) ; R.C.(mA rms) at 105°C 100KHz ; IMP (Ω max)at 20°C 100KHz.

Cap (μF)	V	6.3			10			16			25		
		Item	D x L	R.C.	IMP	D x L	R.C.	IMP	D x L	R.C.	IMP	D x L	R.C.
68											5x12	460	0.390
120								5x12	460	0.390			
150					5x12	460	0.390				6.3x12	690	0.160
220		5x12	350	0.390									
270								6.3x12	690	0.160			
330					6.3x12	690	0.160				8x12	1210	0.074
390											8x16	1610	0.058
470		6.3x12	530	0.180				8x12	1210	0.074	10x13	1690	0.052
560					8x12	1210	0.074	8x16	1610	0.058	8x20	1970	0.040
680					8x16	1610	0.058	10x13	1690	0.052	10x16	1990	0.037
820		8x12	940	0.074	10x13	1690	0.052	8x20	1970	0.040			
1000		8x16	1245	0.060	8x20	1970	0.040	10x16	1990	0.037	10x20	2520	0.027
1200		10x13	1510	0.052	10x16	1990	0.037				10x25	2910	0.023
1500		8x20	1510	0.042				10x20	2520	0.027	13x21	2610	0.024
1800		10x16	1765	0.037	10x20	2520	0.027	10x25	2910	0.023	13x25	3060	0.018
2200					10x25	2910	0.023	13x21	2610	0.024	13x30	3490	0.017
2700		10x20	1965	0.027	13x21	2610	0.024	13x25	3060	0.018	16x22	3250	0.021
3300		10x25	2260	0.023	13x25	3060	0.018	13x30	3490	0.017	16x25	3650	0.017
3900		13x21	2485	0.024				16x22	3250	0.021			
4700		13x25	2910	0.019	13x30	3490	0.017	13x35	3650	0.016			
5600		13x30	3455	0.017	16x22	3250	0.021	16x25	3650	0.017			
6800		13x35	3565	0.015	16x25	3650	0.017						
8200		16x22	3245	0.021									
		16x26	3640	0.017									

※ 13mm may be replaced by 12.5mm upon customer's request.

HX series

STANDARD RATINGS

D×L(mm) ; R.C.(mA rms) at 105°C 100KHz ; IMP (Ω max)at 20°C 100KHz.

Cap (μF)	V	35			50			63			
		Item	D x L	R.C.	IMP	D x L	R.C.	IMP	D x L	R.C.	IMP
18											
27					5x12	300	0.48	5x12	250	0.700	
33											
47		5x12	460	0.39				6.3x12	430	0.500	
56					6.3x12	490	0.23	8x12	500	0.350	
68											
82								8x12	720	0.350	
100		6.3x12	690	0.16	8x12	940	0.13	8x16	990	0.300	
120					8x16	1240	0.081	10x13	990	0.280	
150					8x20	1600	0.057	8x20	1200	0.200	
					10x13	1270	0.072				
180		8x12	1210	0.074				10x16	1200	0.100	
220		8x16	1610	0.058	10x16	1645	0.052				
270		10x13	1690	0.052				10x20	1580	0.080	
330		8x20	1970	0.04	10x20	2065	0.037	10x25	1990	0.075	
390		10x16	1990	0.037	10x25	2250	0.031	13x21	1990	0.065	
470					13x21	2210	0.032	13x25	2450	0.055	
560		10x20	2520	0.027				13x30	2750	0.05	
							16x22	2150	0.052		
680		10x25	2910	0.023	13x25	2510	0.026	13x35	3050	0.045	
820		13x21	2610	0.024	13x30	3100	0.023	16x26	2560	0.048	
					16x22	2750	0.026				
1000					13x35	3250	0.021				
					16x25	3000	0.022				
1200		13x25	3060	0.017							
1500		13x30	3490	0.017							
		16x22	3250	0.021							
1800		13x35	3620	0.016							
		16x25	3650	0.017							

Cap (μF)	V	80			100			
		Item	D x L	R.C.	IMP	D x L	R.C.	IMP
8.2								
12			5x12	230		5x12	230	1.200
18						6.3x12	360	0.580
27			6.3x12	380		8x12	450	0.430
33						8x12	630	0.430
47			8x12	630		8x16	780	0.400
56			8x16	780		10x13	780	0.330
68			10x13	780		8x20	1050	0.250
					10x16	1050	0.300	
82			8x20	1050				
100			10x16	1050		10x20	1400	0.250
					13x16	1400	0.130	
120						10x25	1650	0.085
150			10x20	1400		13x21	1750	0.065
			13x16	1400				
180			10x25	1650				
220			13x21	1750		13x25	2200	0.063
270			13x25	2200		13x30	2400	0.055
					16x22	1950	0.058	
330			13x30	2400		13x35	2600	0.050
			16x22	1950				
390			13x35	2600		13x40	2860	0.045
					16x25	2450	0.043	
470			13x40	2860		16x32	2650	0.038
			16x25	2450		18x22	2270	0.048
						18x25	2500	0.042
560			16x32	2650		16x36	2860	0.036
					18x32	2860	0.036	
680			16x36	2860		16x40	3500	0.033
			18x25	2500		18x36	3500	0.033
820			16x40	3500		18x40	3860	0.030
			18x32	2860				
1000			18x35	3500				

※ 13mm may be replaced by 12.5mm upon customer's request.

SN series

- Non-polarity standard product, 85°C 2000hours.
- Suitable for DC two-way return circuit.
- RoHS Compliance
- 無極性 85°C 2000小時標準品。
- 適用於直流雙向迴路。

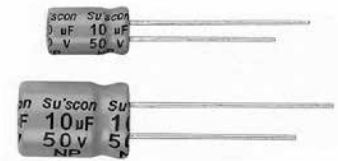

SPECIFICATIONS

Items 項目	Characteristics 特性									
Capacitance Tolerance 靜電容量誤差	± 20%(120Hz,20°C)									
Operating Temperature Range 適用溫度範圍	-40 ~ +85°C									
Rated Voltage Range 額定電壓範圍	6.3 ~ 100VDC									
Leakage Current 洩漏電流	I ≤ 0.03CV or 3 (µA) which is greater. (After 5 minutes application of DC rated voltage, at 20 °C)									
Dissipation Factor 散逸因素(tan δ)	Measurement Frequency: 120Hz. Temperature: 20°C									
	Rated Voltage(V)	6.3	10	16	25	35	50	63	100	
	tan δ(Max)	0.26	0.24	0.22	0.20	0.16	0.14	0.12	0.10	
When nominal capacitance over 1000µF, tanδ shall be added 0.02 to the listed value with increase of every 1000µF.										
Low Temperature Stability 低溫特性 Impedance Ratio(Max) 阻抗比率(最大值)	Measurement Frequency: 120Hz.									
	Rated Voltage(V)	6.3	10	16	25	35	50	63	100	
	Z(-25°C)/Z(20°C)	4	3	2	2	2	2	2	2	
Z(-40°C)/Z(20°C)										
10 8 6 5 4 4 3 3										
Load Life 負荷壽命	The following specifications shall be satisfied when the capacitors are restored to 20°C after subjected to DC voltage with the rated ripple current is applied for 2,000 hours with the polarity inverted every 250 hours at 85°C.									
	Capacitance Change	Within ± 20% of Initial Value								
	tan δ	200% or less of Initial Specified Value								
	Leakage Current	Initial Specified Value or less								
Shelf Life 放置壽命	The following specifications shall be satisfied when the capacitors are restored to 20°C after exposing them for 1,000 hours 85°C without voltage applied. Before the measurement, the capacitor shall be preconditioned by applying voltage according to them 4.1 of JIS C5101-4.									
	Capacitance Change	Within ± 20% of Initial Value								
	tan δ	200% or less of Initial Specified Value								
	Leakage Current	Initial Specified Value or less								
Standards 參照標準	JIS C 5101-4 (IEC 60384)									

SN

Frequency Coefficient of Permissible Ripple Current

Capacitance (µF)	Frequency (Hz)			
	50	120	1K	≥10K
< 100	0.80	1.00	1.30	1.50
≥ 100	0.80	1.00	1.15	1.20

The endurance of capacitors is reduced with internal heating produced by ripple current at the rate of halving the lifetime with every 10°C rise. When long life performance is required in actual use , the rms ripple current has to be reduced.

SN series

DIMENSIONS(mm)

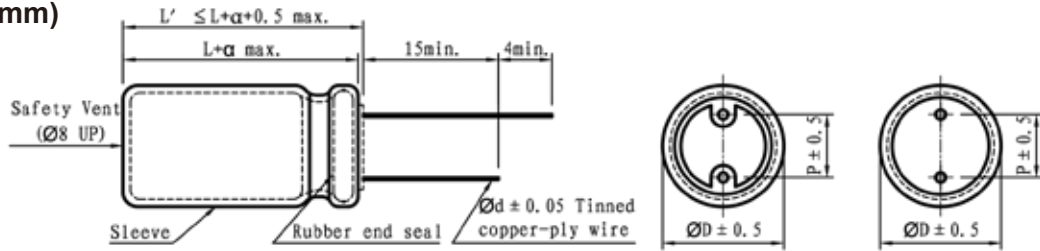

α	(L < 16) 1.0
	(L ≥ 16) 2.0

STANDARD RATINGS

D×L(mm) ; R.C.(mA rms) at 85°C 120Hz

Cap (µF)	V	6.3		10		16		25	
		D x L	R.C.	D x L	R.C.	D x L	R.C.	D x L	R.C.
4.7						4x7	19	5x7	22
10						5x7	30	5x11	45
				4x7	24	5x11	42	6.3x7	35
22				5x7	41	5x11	59	6.3x7	53
				5x11	57	6.3x7	51	6.3x11	66
33		5x7	43	5x11	67	6.3x7	64	6.3x11	88
		5x11	63	6.3x7	56	6.3x11	80	8x7	74
47		6.3x7	58	6.3x7	67	6.3x7	75	8x7	87
		5x11	76	6.3x11	83	6.3x11	95	8x12	100
100		6.3x11	125	6.3x11	128	8x7	125	8x14	160
		8x7	96	8x7	110	8x12	160		
220		8x7	140	8x14	215	10x16	300	10x16	385
		8x12	210						
330		8x14	270	10x16	350	10x16	375	13x21	460
470		10x16	370	10x20	410	10x20	480	13x21	540
1000		10x20	650	13x21	720	13x25	855	16x26	950
2200		13x25	1160	16x26	1280	16x32	1510	18x35	1620
3300		16x26	1570	16x32	1690	18x35	1980		
4700		16x32	2020	18x35	2160				
6800		18x35	2600						

Cap (µF)	V	35		50		63		100	
		D x L	R.C.	D x L	R.C.	D x L	R.C.	D x L	R.C.
0.10				4x7	4				
0.22				4x7	6				
0.33				4x7	7.3				
0.47				4x7	8.9				
0.1~0.47				5x11	11	5x11	11	5x11	14
1.0				4x7	12	5x11	17	5x11	21
				5x11	17				
2.2				4x7	19	5x11	25	6.3x11	33
				5x11	25				
3.3				5x7	25	5x11	37	6.3x11	39
		4x7	20	5x11	28				
4.7				5x7	30	6.3x11	47	8x12	57
		5x11	34	6.3x7	38				
10				5x11	45	8x12	68	8x14	80
		6.3x7	48	8x7	54				
22				6.3x11	74	8x14	95	10x16	135
		8x7	62	8x12	88				
33				8x7	76	10x16	135	13x21	220
		8x12	105	8x14	105				
47		8x14	125	10x16	150	10x20	180	13x21	240
100		10x16	230	10x20	265	13x21	320	16x26	430
220		13x21	420	13x25	480	16x26	570	18x35	720
330		13x21	510	16x26	650	16x32	660		
470		13x25	660	16x32	840	18x35	965		
1000		16x32	1140						

※ 13mm may be replaced by 12.5mm upon customer's request.

NS

HN series

- Non-polarity standard product, 105°C 2000hours.
- Suitable for DC two-way return circuit.
- RoHS Compliance
- 無極性105°C 2000小時標準品。
- 適用於直流雙向迴路。



SPECIFICATIONS

Items 項目	Characteristics 特性									
Capacitance Tolerance 靜電容量誤差	± 20%(120Hz,20°C)									
Operating Temperature Range 適用溫度範圍	-40 ~ +105°C									
Rated Voltage Range 額定電壓範圍	6.3 ~ 160VDC									
Leakage Current 洩漏電流	I ≤ 0.03CV or 3 (μA) which is greater.(After 5 minutes application of DC rated voltage, at 20 °C)									
Dissipation Factor 散逸因素(tan δ)	Measurement Frequency: 120Hz. Temperature: 20°C									
	Rated Voltage(V)	6.3	10	16	25	35	50	63	100	160
	tan δ(Max)	0.26	0.24	0.22	0.20	0.16	0.14	0.12	0.10	0.15
When nominal capacitance over 1000μF, tanδ shall be added 0.02 to the listed value with increase of every 1000μF .										
Low Temperature Stability 低溫特性 Impedance Ratio(Max) 阻抗比率(最大值)	Measurement Frequency: 120Hz.									
	Rated Voltage(V)	6.3	10	16	25	35	50	63	100	160
	Z(-25°C)/Z(20°C)	4	3	2	2	2	2	2	2	3
	Z(-40°C)/Z(20°C)	10	8	6	5	4	4	3	3	4
Load Life 負荷壽命	The following specifications shall be satisfied when the capacitors are restored to 20°C after subjected to DC voltage with the rated ripple current is applied for 2,000 hours with the polarity inverted every 250 hours at 105°C.									
	Capacitance Change	Within ± 20% of Initial Value								
	tan δ	200% or less of Initial Specified Value								
	Leakage Current	Initial Specified Value or less								
Shelf Life 放置壽命	The following specifications shall be satisfied when the capacitors are restored to 20°C after exposing them for 1,000 hours 105°C without voltage applied. Before the measurement, the capacitor shall be preconditioned by applying voltage according to them 4.1 of JIS C5101-4.									
	Capacitance Change	Within ± 20% of Initial Value								
	tan δ	200% or less of Initial Specified Value								
	Leakage Current	Initial Specified Value or less								
Standards 參照標準	JIS C 5101-4 (IEC 60384)									

Frequency Coefficient of Permissible Ripple Current

Capacitance (μF)	Frequency (Hz)			
	50	120	1K	≥10K
< 100	0.80	1.00	1.30	1.50
≥ 100	0.80	1.00	1.15	1.20

The endurance of capacitors is reduced with internal heating produced by ripple current at the rate of halving the lifetime with every 5°C rise. When long life performance is required in actual use , the rms ripple current has to be reduced.

HN

HN series

DIMENSIONS(mm)

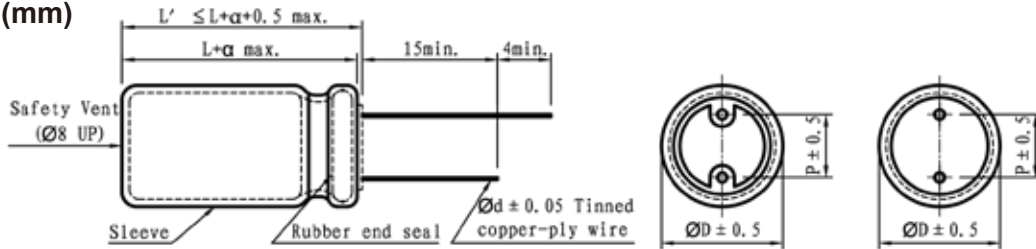

ϕD	4	5	6.3	8	10	13	16
P	1.5	2.0	2.5	3.5	5.0	5.0	7.5
ϕd	0.45	0.5	0.5	0.5	0.6	0.6	0.8

α	(L < 16) 1.0
	(L \geq 16) 2.0

STANDARD RATINGS

D×L (mm) ; R.C.(mA rms) at 105°C 120Hz

Cap (μF)	V	6.3		10		16		25	
		D x L	R.C.	D x L	R.C.	D x L	R.C.	D x L	R.C.
3.3								4x7	15
4.7						4x7	18	5x7	18
10				4x7	23	5x7	27	5x11	36
						5x11	30	6.3x7	28
22	5x7	33	5x7	36	6.3x7	41	6.3x11	55	
			5x11	42	6.3x11	52	8x7	42	
33	5x7	40	6.3x7	45	6.3x11	66	8x12	75	
	5x11	48	6.3x11	58	8x7	52			
47	6.3x7	49	6.3x11	70	8x12	90	10x13	96	
	6.3x11	65	8x7	55					
100	8x12	105	10x13	125	10x13	140	10x16	158	
220	10x13	168	10x16	205	10x20	285	13x21	306	
330	10x16	230	10x20	278	13x21	346	13x25	415	
470	10x20	330	13x21	370	13x25	460	16x26	545	
1000	13x25	550	16x26	665	16x26	750	16x32	870	

Cap (μF)	V	35		50		63		100		160	
		D x L	R.C.	D x L	R.C.	D x L	R.C.	D x L	R.C.	D x L	R.C.
0.1				4x7	2.1	4x7	2.6				
0.22				4x7	4.5	4x7	5.0				
0.33				4x7	5.6	4x7	6.1				
0.47				4x7	6.6	4x7	7.3				
0.1~0.47				5x11	8	5x11	5	5x11	10	6.3x11	10
				4x7	9.7	4x7	10	5x11	15	8x12	17
			5x11	12	5x11	15					
2.2	4x7	13	5x7	14	5x7	16	6.3x11	24	8x12	20	
			5x11	18	5x11	22					
3.3	5x7	16	5x7	18	6.3x7	20	8x12	32	8x12	25	
			5x11	22	6.3x11	26					
4.7	5x7	20	6.3x7	22	6.3x11	32	8x12	40	8x12	30	
	5x11	25	6.3x11	30	8x7	24					
5.6	5x11	28	6.3x11	35	6.3x11	40	8x12	48	8x14	35	
6.8	5x11	33	6.3x11	40	8x12	45	8x14	52	8x16	41	
10	6.3x11	40	8x12	50	8x12	55	10x13	65	10x16	55	
	8x7	30									
22	8x12	68	10x13	82	10x16	90	10x20	120	13x21	106	
33	10x13	90	10x16	100	10x20	128	13x21	168	13x21	130	
47	10x13	110	10x20	146	10x20	156	13x21	200	13x25	167	
56	10x16	140	13x21	195	13x21	218	13x21	250	16x26	206	
100	10x20	196	13x25	260	13x25	275	13x25	295	16x32	300	
220	13x25	365	16x26	445	16x32	486					
330	16x26	492	16x32	595							
470	16x32	595									

※ 13mm may be replaced by 12.5mm upon customer's request.

HN

HR series

- Non-polarity, low E.S.R., ripple current high frequency and high-temperature resistance.
- Suitable for propoitive amplifier of high-grade audio and horizontal compensatory return circuit of TV set.
- RoHS Compliance.
- 無極性、低阻抗、耐高紋波、高頻率、耐高溫產品。
- 適用於高級音響的前置放大器及電視機的水平補償迴路。

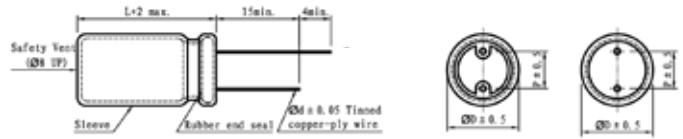

φ D	10	13	16
P	5.0	5.0	7.5
φ d	0.6	0.6	0.8

SPECIFICATIONS

Items 項目	Characteristics 特性				
Capacitance Tolerance 靜電容量誤差	± 20%(120Hz,20°C)				
Operating Temperature Range 適用溫度範圍	-40 ~ +105°C				
Rated Voltage Range 額定電壓範圍	25、35、50、100VDC				
Leakage Current 洩漏電流	After 5 minutes application of DC rated voltage, leakage current is 100µA or less.				
Dissipation Factor 散逸因素(tan δ)	0.05 Max. measured at 120Hz, 20°C				
Low Temperature Stability 低溫特性 Impedance Ratio(Max) 阻抗比率(最大值)	Measurement Frequency: 120Hz.				
	Rated Voltage(V)	25	35	50	100
	Z(-25°C)/Z(20°C)	3	3	3	3
	Z(-40°C)/Z(20°C)	4	4	4	4
Load Life 負荷壽命	The following specifications shall be satisfied when the capacitors are restored to 20°C after subjected to DC voltage with the rated ripple current is applied for 1,000 hours at 105°C.				
	Capacitance Change	Within ± 15% of Initial Value			
	tan δ	200% or less of Initial Specified Value			
	Leakage Current	Initial Specified Value or less			
Shelf Life 放置壽命	The following specifications shall be satisfied when the capacitors are restored to 20°C after exposing them for 1,000 hours 105°C without voltage applied. Before the measurement, the capacitor shall be preconditioned by applying voltage according to them 4.1 of JIS C5101-4.				
	Capacitance Change	Within ± 15% of Initial Value			
	tan δ	200% or less of Initial Specified Value			
	Leakage Current	Initial Specified Value or less			
Standards 參照標準	JIS C 5101-4 (IEC 60384)				

STANDARD RATINGS

D×L (mm), R.C. A(p-p)15.75KHz at 105°C, E.S.R. (Ω)at 20°C 120Hz.

Cap (µF)	V	25			35 50 100			
		Item	D x L	R.C.	E.S.R	D x L	R.C.	E.S.R
2.2			10x20	2.8	30.20	13x25	3.0	30.20
2.7			13x21	3.5	24.23	13x25	4.5	24.23
3.3			13x21	4.0	20.12	16x26	5.0	20.12
4.7			13x21	5.0	14.30	16x26	6.5	14.30
5.6			13x25	6.0	9.80	16x32	6.5	9.80
6.8			16x26	7.0	8.10	16x36	7.5	8.10
8.2			16x26	7.5	7.05	16x36	8.0	7.05
10			16x32	9.0	5.60			

※ 13mm may be replaced by 12.5mm upon customer's request.

HR

SA/SB series

- Low leakage current product.
- Suitable for prepositive amplifier of high-grade audio and oscillating return of TV set.
- RoHS Compliance.
- 低洩漏電流產品。
- 適用於高級音響的前置放大器及電視機的振盪迴路等。

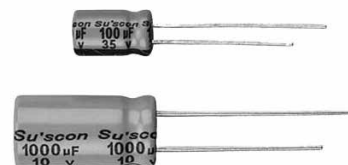

SPECIFICATIONS

Items 項目	Characteristics 特性									
Capacitance Tolerance 靜電容量誤差	± 20%(120Hz,20°C)									
Operating Temperature Range 適用溫度範圍	SA : -40 ~ +85°C SB : -40 ~ +105°C									
Rated Voltage Range 額定電壓範圍	6.3 ~ 100VDC									
Leakage Current 洩漏電流	I ≤ 0.002CV or 0.4 (µA) , which is greater. (After 2 minutes application of DC rated voltage, at 20 °C)									
Dissipation Factor 散逸因素(tan δ)	Measurement Frequency: 120Hz. Temperature: 20°C									
	Rated Voltage(V)	6.3	10	16	25	35	50	63	100	
	tan δ(Max)	0.24	0.20	0.16	0.15	0.12	0.10	0.09	0.08	
When nominal capacitance over 1000µF, tanδ shall be added 0.02 to the listed value with increase of every 1000µF.										
Low Temperature Stability 低溫特性 Impedance Ratio(Max) 阻抗比率(最大值)	Measurement Frequency: 120Hz.									
	Rated Voltage(V)	6.3	10	16	25	35	50	63	100	
	Z(-25°C)/Z(20°C)	4	3	2	2	2	2	2	2	
Z(-40°C)/Z(20°C)										
Load Life 負荷壽命	The following specifications shall be satisfied when the capacitors are restored to 20°C after subjected to DC voltage with the rated ripple current is applied for 1,000 hours at 105°C.									
	Capacitance Change	Within ± 25% of Initial Value								
	tan δ	200% or less of Initial Specified Value								
	Leakage Current	Initial Specified Value or less								
Shelf Life 放置壽命	The following specifications shall be satisfied when the capacitors are restored to 20°C after exposing them for 1,000 hours 85°C and 105°C without voltage applied. Before the measurement, the capacitor shall be preconditioned by applying voltage according to them 4.1 of JIS C5101-4.									
	Capacitance Change	Within ± 25% of Initial Value								
	tan δ	200% or less of Initial Specified Value								
	Leakage Current	Initial Specified Value or less								
Standards 參照標準	JIS C 5101-4 (IEC 60384)									

Frequency Coefficient of Permissible Ripple Current

Capacitance (µF)	Frequency (Hz)			
	50	120	1K	10K
< 100	0.80	1.00	1.30	1.50
100 ~ 1000	0.80	1.00	1.15	1.20
> 1000	0.80	1.00	1.10	1.15

The endurance of capacitors is reduced with internal heating produced by ripple current at the rate of halving the lifetime with every 5°C rise. When long life performance is required in actual use , the rms ripple current has to be reduced.

SA/SBseries

DIMENSIONS(mm)

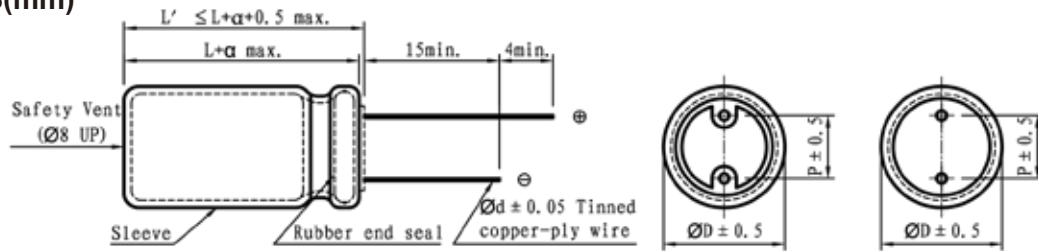

ϕD	5	6.3	8	10	13	16	18
P	2.0	2.5	3.5	5.0	5.0	7.5	7.5
ϕd	0.5	0.5	0.5	0.6	0.6	0.8	0.8

α	(L < 16) 1.0 (L ≥ 16) 2.0
----------	------------------------------

STANDARD RATINGS

D×L (mm) ; R.C.(mA rms) at 85°C/105°C 120Hz

Cap (μF)	V	6.3		10		16		25	
		D x L	R.C.	D x L	R.C.	D x L	R.C.	D x L	R.C.
4.7								5x11	45
6.8								5x11	55
10						5x11	55	5x11	70
15						5x11	70	5x11	85
22						5x11	85	5x11	100
33						5x11	100	6.3x11	140
47				5x11	100	6.3x11	140	6.3x11	170
68				6.3x11	150	6.3x11	160	8x12	230
100				6.3x11	180	8x12	230	8x12	280
150				8x12	250	8x12	280	10x13	370
220				8x12	310	10x13	370	10x16	400
330				10x13	400	10x16	420	10x20	490
470	10x13	385		10x16	530	10x16	550	10x20	650
680	10x13	480		10x16	600	10x20	720	13x21	800
1000	10x16	640		10x20	780	13x21	900	13x25	1000
1500	10x20	900		13x25	1020	16x26	1150	16x32	1270
2200	13x21	1050		13x25	1200	16x26	1300	16x36	1440
3300	16x26	1300		16x32	1420	16x36	1550	18x40	1720
4700	16x32	1500		16x36	1650	18x35	1820		

Cap (μF)	V	35		50		63		100	
		D x L	R.C.	D x L	R.C.	D x L	R.C.	D x L	R.C.
0.1				5x11	1.1			5x11	2.1
0.15				5x11	1.6			5x11	3.2
0.22				5x11	2.3			5x11	4.7
0.33				5x11	3.5			5x11	7.0
0.47				5x11	5.0			5x11	10.1
0.68				5x11	7.3			5x11	14.5
1				5x11	10.7			5x11	19
1.5				5x11	16			5x11	23
2.2				5x11	23			5x11	28
3.3				5x11	40			5x11	45
4.7	5x11	45		5x11	45			5x11	50
6.8	5x11	55		5x11	55	5x11	59	6.3x11	65
10	5x11	70		5x11	70	6.3x11	75	8x12	90
15	5x11	85		6.3x11	95	6.3x11	100	8x12	110
22	6.3x11	110		6.3x11	110	8x12	115	10x13	136
33	6.3x11	140		8x12	165	8x12	170	10x16	180
47	8x12	190		8x12	190	10x13	200	10x20	220
68	8x12	230		10x13	250	10x16	270	10x20	290
100	10x13	300		10x16	320	10x20	330	13x21	370
150	10x16	400		10x20	420	13x21	450	13x25	470
220	10x20	440		13x21	490	13x21	550	16x26	580
330	13x21	550		13x21	600	13x25	710	16x32	730
470	13x25	680		13x25	750	16x26	850	18x35	910
680	13x25	800		16x26	910	16x32	1050		
1000	16x26	1110		16x32	1140	18x35	1330		
1500	16x32	1390		18x40	1480				
2200	18x35	1580							

※ 13mm may be replaced by 12.5mm upon customer's request.

SA/SB

AK series

- Protective countermeasure against DC over-voltage, 105°C 2000hours.
- RoHS Compliance.
- DC過電壓安全對策 105°C 2000小時。



SPECIFICATIONS

Items 項目	Characteristics 特性		
Capacitance Tolerance 靜電容量誤差	± 20%(120Hz,20°C)		
Operating Temperature Range 適用溫度範圍	-25 ~ +105°C		
Rated Voltage Range 額定電壓範圍	200VDC、400VDC		
Leakage Current 洩漏電流	$I \leq 0.04CV + 100 (\mu A)$ (After 1 minutes application of DC rated voltage, at 20 °C)		
Dissipation Factor 散逸因素(tan δ)	Measurement Frequency: 120Hz. Temperature: 20°C		
	Rated Voltage(V)	200	400
	tan δ(Max)	0.15	0.15
Low Temperature Stability 低溫特性 Impedance Ratio(Max) 阻抗比率(最大值)	Measurement Frequency: 120Hz.		
	Rated Voltage(V)	200	400
	Z(-25°C)/Z(20°C)	4	6
Load Life 負荷壽命	The following specifications shall be satisfied when the capacitors are restored to 20°C after subjected to DC voltage with the rated ripple current is applied for 2,000 hours at 105°C.		
	Capacitance Change	Within ± 20% of Initial Value	
	tan δ	200% or less of the Initial Specified Value	
	Leakage Current	Initial Specified Value or less	
Shelf Life 放置壽命	The following specifications shall be satisfied when the capacitors are restored to 20°C after exposing them for 1,000 hours 105°C without voltage applied. Before the measurement, the capacitor shall be preconditioned by applying voltage according to them 4.1 of JIS C5101-4.		
	Capacitance Change	Within ± 20% of Initial Value	
	tan δ	200% or less of Initial Specified Value	
	Leakage Current	Initial Specified Value or less	
Standards 參照標準	JIS C 5101-4 (IEC 60384)		

◆ DC over voltage test conditions

The vent will be operated and the capacitor shall become an open circuit without burning materials when the following excess DC voltage is applied.

TEST DC VOLTAGE

Rated Voltage	Current Limit	Test DC Voltage
200 Vdc	4A	300 / 375 Vdc
400 Vdc	2A	500 / 600 Vdc

TEST CIRCUIT

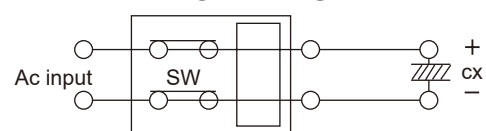

Frequency Coefficient of Permissible Ripple Current

Rated Voltage (V)	Capacitance (μF)	Frequency (Hz)				
		60(50)	120	150	1K	≥10K
200	22 ~ 470	0.85	1.00	1.30	1.50	1.85
	4.7 ~ 68	0.85	1.00	1.20	1.30	1.50
400	82 ~ 220	0.85	1.00	1.10	1.15	1.20

The endurance of capacitors is reduced with internal heating produced by ripple current at the rate of halving the lifetime with every 5°C rise. When long life performance is required in actual use, the rms ripple current has to be reduced.

AK series

DIMENSIONS(mm)

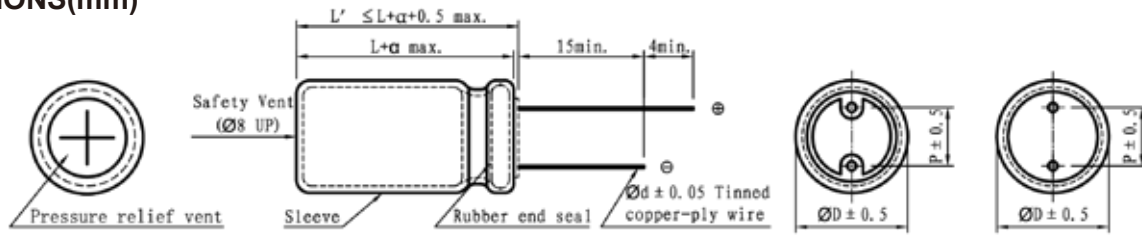

ϕD	10	13	16	18	20	22
P	5.0	5.0	7.5	7.5	10	10
ϕd	0.6	0.6	0.8	0.8	0.8	0.8

α	(L < 16) 1.0
	(L ≥ 16) 2.0

STANDARD RATINGS

D×L (mm) ; R.C.(mA rms) at 105°C 120Hz

V	Cap (μF)	D x L	R.C.
200	22	10x20	120
	33	10x25	160
		13x21	160
	47	10x30	195
		13x21	195
	56	13x25	210
	68	13x25	250
		16x22	250
	82	13x32	285
		16x22	285
		16x26	305
	100	13x35	335
		16x26	335
		16x36	350
	120	18x21	335
		16x26	450
		16x32	500
	150	18x25	500
		16x32	560
		16x36	585
		18x21	560
	180	18x25	585
		16x36	600
		16x40	645
	220	18x32	645
		18x32	680
		18x35	700
	330	18x40	735
18x35		775	
18x40		810	
390	18x45	920	
	18x40	850	
470	22x40	920	
	18x45	1120	
	22x40	1270	

V	Cap (μF)	D x L	R.C.
400	4.7	10x10	60
	10	10x13	63
		10x16	87
		15	10x20
	18	10x25	115
		13x25	135
		13x30	145
		16x22	145
		16x26	180
	22	13x25	175
		16x26	195
		18x21	225
		18x25	255
	33	13x32	370
		16x26	268
		16x32	275
		16x36	290
		18x21	275
		18x25	290
	47	18x32	310
		16x32	326
		16x36	338
		16x40	350
		18x32	320
		16x36	320
		16x40	360
	56	18x25	350
		18x32	360
		18x35	380
		16x32	395
	68	18x25	395
		18x32	400
18x40		420	
18x28		450	
82	18x32	470	
	18x35	490	
	18x40	510	
100	18x32	515	
	18x35	530	
	18x40	550	
120	18x35	770	
	18x40	790	
	18x40	800	
150	22x35	800	
	22x40	1000	

AK

YR series

- Ideally suited for first class audio equipment where qualitative and quantitative comfortableness is required.
- RoHS Compliance
- 適用於高級音響器材 當要求舒適的音頻質量。
- 環境對策品。

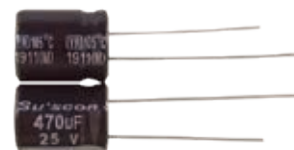

SPECIFICATIONS

Items 項目	Characteristics 特性									
Capacitance Tolerance 靜電容量誤差	± 20%(120Hz,20°C)									
Operating Temperature Range 適用溫度範圍	-40 ~ +105°C									
Rated Voltage Range 額定電壓範圍	6.3 ~ 160VDC									
Leakage Current 洩漏電流	$I \leq 0.01CV$ or 3 (uA) (After 1 minute application of working voltage)									
Dissipation Factor 散逸因素(tan δ)	Measurement Frequency: 120Hz. Temperature: 20°C									
	Rated Voltage(V)	6.3	10	16	25	35	50	63	80	100
	tan δ (Max)	0.22	0.19	0.16	0.14	0.12	0.10	0.09	0.09	0.08
When nominal capacitance over 1000 μ F, tan δ shall be added 0.02 to the listed value with increase of every 1000 μ F.										
Low Temperature Stability 低溫特性 Impedance Ratio(Max) 阻抗比率(最大值)	Measurement Frequency: 120Hz.									
	Rated Voltage(V)	6.3	10	16	25	35	50	63	80	100
	Z(-25°C)/Z(20°C)	5	4	3	2	2	2	2	2	2
Z(-40°C)/Z(20°C)	10	8	6	4	3	3	3	3	3	
Load Life 負荷壽命	2000hours, with application of working voltage at 105°C									
	Capacitance Change	Within ± 20% of Initial Value								
	tan δ	200% or less of Initial Specified Value								
	Leakage Current	Initial Specified Value or less								
Shelf Life 放置壽命	The following specifications shall be satisfied when the capacitors are restored to 20°C after exposing them for 1000hours 105°C without voltage applied. Before the measurement. The Capacitance shall be preconditioned by applying voltage according to them 4.1 of JIS C5101-4.									
	Capacitance Change	Within ± 20% of Initial Value								
	tan δ	200% or less of Initial Specified Value								
	Leakage Current	Initial Specified Value or less								
Standards 參照標準	JIS C 5101-4-1 (IEC 60384)									

Frequency Coefficient of Permissible Ripple Current

Capacitance (μ F)	Frequency (Hz)				
	50	120	300	1K	10K
1 ~ 47	0.75	1.00	1.35	1.57	2.00
100 ~ 470	0.80	1.00	1.23	1.34	1.50
1000 ~ 10000	0.85	1.00	1.10	1.13	1.15

The endurance of capacitors is reduced with internal heating produced by ripple current at the rate of halving the lifetime with every 5°C rise. When long life performance is required in actual use , the rms ripple current has to be reduced.

YR series

DIMENSIONS(mm)

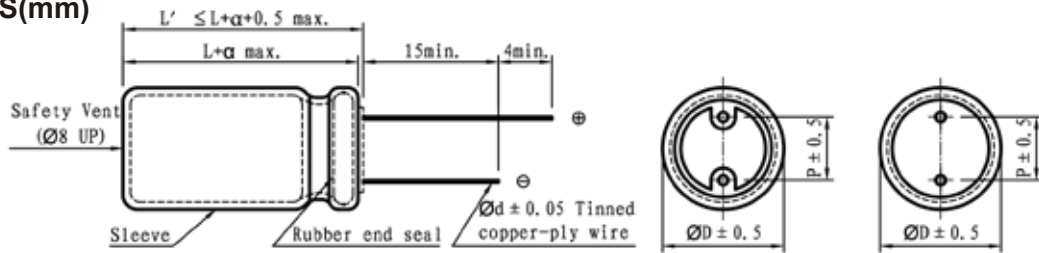

ϕD	5	6.3	8	10	12.5	16	18
P	2.0	2.5	3.5	5.0	5.0	7.5	7.5
ϕd	0.5	0.5	0.5	0.6	0.6	0.8	0.8

α	(L < 16) 1.0
	(L ≥ 16) 2.0

STANDARD RATINGS

DxL(mm), R.C.(mA rms) at 105°C 120 Hz.

Cap (µF)	V	6.3		10		16		25		35		50	
		Item	D x L	R.C.		D x L	R.C.		D x L	R.C.			
1												5x11	9
2.2												5x11	18
3.3												5x11	22
4.7												5x11	27
10												5x11	39
22								5x11	50	6.3x11	60	6.3x11	65
33						5x11	57	6.3x11	70	6.3x11	75	8x12	93
47				5x11	60	6.3x11	74	6.3x11	85	8x12	101	8x12	111
100				6.3x11	99	8x12	128	8x12	140	10x13	176	10x16	215
220				8x12	170	10x13	226	10x16	260	10x20	320	12.5x20	390
330				10x13	247	10x16	309	10x20	351	12.5x20	446	12.5x20	488
470	10x13	270	10x16	330	10x20	406	12.5x20	476	12.5x25	590	16x25	650	
1000	10x20	485	12.5x20	601	12.5x25	723	16x25	854	16x25	1060	16x32	1,143	
2200	12.5x25	867	16x25	1047	16x25	1290	16x35	1570	18x35	1840			
3300	16x25	1135	16x32	1520	16x35	1720	18x40	1794					
4700	16x32	1431	16x35	1840	18x35	2140							
6800	18x35	1810	18x40	2049									
10000	18x40	2100											

Cap (µF)	V	63		80		100		
		Item	D x L	R.C.	D x L	R.C.	D x L	R.C.
1						5x11	15	
2.2						5x11	22	
3.3						5x11	27	
4.7						5x11	36	
10		6.3x11		50	6.3x11	55	8x12	65
22		8x12		85	8x12	100	10x13	110
33		8x12		105	10x13	130	10x16	150
47		10x13		140	10x16	170	10x20	190
100		10x20		255	12.5x20	270	12.5x20	300
220		12.5x20		420	12.5x25	490	16x25	549
330		12.5x25		541	16x32	650	16x32	734
470		16x25		840	16x35	920	18x35	980
1000		18x35		1400				

※ 13mm may be replaced by 12.5mm upon customer's request.

YR

SDN series

- Anhydrous product.
- Low impedance at High frequency range, high ripple current resistance.
- Suitable for return-circuit of switching power source.
- RoHS Compliance
- 無水系產品。
- 高頻低阻抗、耐高紋波。
- 適用於開關電源迴路。

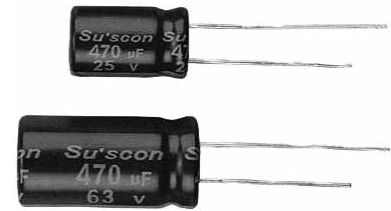

SPECIFICATIONS

Items 項目	Characteristics 特性										
Capacitance Tolerance 靜電容量誤差	± 20%(120Hz,20°C)										
Operating Temperature Range 適用溫度範圍	-55 ~ +105°C					-40 ~ +105°C					
Rated Voltage Range 額定電壓範圍	6.3 ~ 100VDC					160 ~ 400VDC					
Leakage Current 洩漏電流	$V \leq 100V \quad I \leq 0.01CV \text{ or } 3 (\mu A)$ (After 2 minutes application of DC rated voltage, at 20 °C) $V > 100V \quad I \leq 0.03CV + 20 (\mu A)$ (After 5 minutes application of DC rated voltage, at 20 °C)										
Dissipation Factor 散逸因素 (tan δ)	Measurement Frequency: 120Hz. Temperature: 20°C										
	Rated Voltage(V)	6.3	10	16	25	35	50	63	100	160~250	400
	tan δ(Max)	0.22	0.19	0.16	0.14	0.12	0.10	0.08	0.07	0.20	0.24
When nominal capacitance over 1000μF, tanδ shall be added 0.02 to the listed value with increase of every 1000μF.											
Low Temperature Stability 低溫特性 Impedance Ratio(Max) 阻抗比率(最大值)	Measurement Frequency: 120Hz.										
	Rated Voltage(V)	6.3	10	16	25	35	50	63	100	160~250	400
	Z(-25°C)/Z(20°C)	4	3	2	2	2	2	2	2	3	6
	Z(-40°C)/Z(20°C)	-	-	-	-	-	-	3	3	6	12
Z(-55°C)/Z(20°C)	8	6	4	3	3	3	-	-	-	-	
Load Life 負荷壽命	The following specifications shall be satisfied when the capacitors are restored to 20°C after subjected to DC voltage with the rated ripple current is applied for 2,000 hours at 105°C.										
	Capacitance Change	Within ± 20% of Initial Value									
	tan δ	200% or less of Initial Specified Value									
	Leakage Current	Initial Specified Value or less									
Shelf Life 放置壽命	The following specifications shall be satisfied when the capacitors are restored to 20°C after exposing them for 1,000 hours 105°C without voltage applied. Before the measurement, the capacitor shall be preconditioned by applying voltage according to them 4.1 of JIS C5101-4.										
	Capacitance Change	Within ± 20% of Initial Value									
	tan δ	200% or less of Initial Specified Value									
	Leakage Current	Initial Specified Value or less									
Standards 參照標準	JIS C 5101-4 (IEC 60384)										

Frequency Coefficient of Permissible Ripple Current

Rated Voltage (V)	Capacitance (μF)	Frequency (Hz)				
		50	120	1K	10K	100K
6.3 ~ 100	47 ~ 100	0.45	0.55	0.75	0.90	1.00
	220 ~ 1000	0.60	0.70	0.85	0.95	1.00
	1500 ~ 15000	0.70	0.80	0.95	0.98	1.00
160 ~ 400	2.2 ~ 330	0.55	0.65	0.80	0.90	1.00

The endurance of capacitors is reduced with internal heating produced by ripple current at the rate of halving the lifetime with every 5°C rise. When long life performance is required in actual use , the rms ripple current has to be reduced.

SDN series

DIMENSIONS(mm)

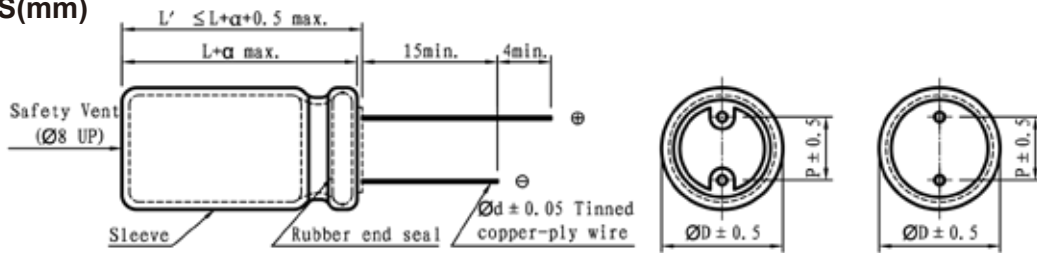

STANDARD RATINGS

D×L (mm) ; R.C.(mA rms) at 105°C 100KHz ; IMP(Ω max) at 20°C 100KHz

Cap (μF)	V	6.3			10			16			25		
		Item	D x L	R.C.	IMP	D x L	R.C.	IMP	D x L	R.C.	IMP	D x L	R.C.
4.7											5x11	50	1.820
10											5x11	80	1.820
22											5x11	110	0.970
47					5x11	140	0.860	5x11	170	0.790	5x11	170	0.790
68					5x11	160	0.860	5x11	210	0.670	6.3x11	210	0.670
100					5x11	180	0.860	6.3x11	270	0.360	6.3x11	270	0.360
220		6.3x11	270	0.430	6.3x11	270	0.400	8x12	440	0.240	8x12	440	0.240
330		6.3x11	320	0.410	8x12	440	0.260	8x12	440	0.240	10x13	650	0.120
470		8x12	440	0.290	8x12	440	0.260	10x13	650	0.120	10x16	800	0.091
680		8x12	440	0.290	10x13	650	0.130	10x16	800	0.091	10x20	1050	0.070
1000		10x13	650	0.140	10x16	800	0.098	10x20	1050	0.070	13x21	1350	0.067
1500		10x16	800	0.100	10x20	1050	0.077	13x21	1350	0.067	13x25	1650	0.048
2200		10x25	1350	0.079	13x21	1350	0.073	13x25	1650	0.052	16x26	2050	0.036
3300		13x21	1350	0.079	13x25	1650	0.065	16x26	2050	0.036	16x32	2550	0.033
4700		13x25	1650	0.051	13x35	2050	0.040	16x32	2550	0.033	18x35	2950	0.031
6800		16x26	2050	0.043	16x32	2550	0.036	18x35	2950	0.031	18x40	3300	0.028
10000		16x32	2550	0.039	18x35	2950	0.034	18x40	3300	0.028			
15000		16x35	2950	0.036	18x40	3300	0.030						

Cap (μF)	V	35			50			63			100		
		Item	D x L	R.C.	IMP	D x L	R.C.	IMP	D x L	R.C.	IMP	D x L	R.C.
0.47					5x11	25	10.73				5x11	20	30.30
1					5x11	40	7.580				5x11	30	28.60
2.2					5x11	55	6.440				5x11	44	14.00
3.3					5x11	65	5.580				5x11	58	9.400
4.7		5x11	85	2.640	5x11	90	3.290	5x11	65	9.880	5x11	74	6.600
10		5x11	100	1.580	5x11	110	2.000	5x11	110	5.450	6.3x11	130	2.600
22		5x11	120	1.320	5x11	140	1.720	6.3x11	200	1.890	8x12	230	2.000
33		5x11	210	0.568	6.3x11	240	0.690	6.3x11	250	1.770	10x13	320	0.700
47		6.3x11	270	0.550	6.3x11	240	0.690	8x12	320	0.800	10x16	390	0.500
68		8x12	360	0.396	8x12	300	0.430	10x13	380	0.760	10x20	420	0.400
100		8x12	440	0.246	8x12	400	0.360	10x13	450	0.670	13x21	580	0.300
220		10x13	650	0.132	10x16	600	0.240	10x20	780	0.340	16x26	880	0.100
330		10x16	800	0.100	10x20	800	0.220	13x21	950	0.210	16x32	930	0.100
470		10x20	1050	0.077	13x21	1050	0.130	13x25	1430	0.170	16x36	1230	0.100
680		13x21	1350	0.073	13x25	1150	0.100	16x26	1780	0.130	18x35	1410	0.091
1000		13x25	1650	0.056	16x26	1550	0.069	16x32	1900	0.100	18x40	1520	0.065
1500		16x26	2050	0.040	16x32	1950	0.061	18x35	2150	0.079			
2200		16x32	2550	0.036	18x35	2250	0.057	18x40	2350	0.077			
3300		18x35	2950	0.034									
4700		18x40	3300	0.030									

※ 13mm may be replaced by 12.5mm upon customer's request.

SDN

SDN series

STANDARD RATINGS

D×L(mm) ; R.C.(mA rms) at 105°C 100KHz

Cap (μF)	V Item	160		200		250		400	
		D x L	R.C.	D x L	R.C.	D x L	R.C.	D x L	R.C.
2.2						8x12	105	8x12	80
3.3		8x12	104	8x12	113	8x12	122	10x13	110
4.7		8x12	112	8x12	126	10x13	140	10x16	160
10		10x13	180	10x13	210	10x16	300	10x20	195
22		10x16	250	10x20	465	13x21	485	13x25	350
33		10x20	570	10x25	600	13x21	620	13x25	580
47		13x21	730	13x21	730	13x25	810	16x26	720
68		13x25	850	13x25	985	16x26	1010	16x32	820
100		16x26	1285	16x26	1285	16x32	1405	18x35	950
150		16x32	1310	16x32	1310	18x32	1455		
220		16x36	1450	18x32	1510	18x40	1490		
330		18x35	1850						

※ 13mm may be replaced by 12.5mm upon customer's request.

HFN series

- Anhydrous product.
- Low impedance at High frequency range.
- High ripple current resistance, 105°C 4000~8000 hours long life.
- RoHS Compliance
- 無水系產品。
- 高頻低阻抗。
- 耐高紋波電流、105°C 4000~8000小時長壽命產品。

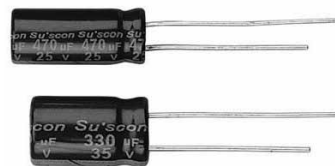

SPECIFICATIONS

Items 項目	Characteristics 特性								
Capacitance Tolerance 靜電容量誤差	± 20%(120Hz,20°C)								
Operating Temperature Range 適用溫度範圍	-55 ~ +105°C				-40 ~ +105°C				
Rated Voltage Range 額定電壓範圍	6.3 ~ 50VDC				63 ~ 100VDC				
Leakage Current 洩漏電流	I ≤ 0.01CV or 3 (μA) which is greater. (After 2 minutes application of DC rated voltage, at 20 °C)								
Dissipation Factor 散逸因素(tan δ)	Rated Voltage(V)	6.3	10	16	25	35	50	63~80	100
	tan δ(Max)	0.24	0.20	0.16	0.15	0.12	0.10	0.09	0.08
When nominal capacitance over 1000μF, tanδ shall be added 0.02 to the listed value with increase of every 1000μF.									
Low Temperature Stability 低溫特性 Impedance Ratio(Max) 阻抗比率(最大值)	Measurement Frequency: 120Hz.								
	Rated Voltage(V)	6.3	10	16	25	35	50	63	100
	Z(-25°C)/Z(20°C)	4	3	2	2	2	2	2	2
	Z(-40°C)/Z(20°C)	-	-	-	-	-	-	3	3
Z(-55°C)/Z(20°C)	8	6	4	3	3	3	-	-	
Load Life 負荷壽命	The following specifications shall be satisfied when the capacitors are restored to 20°C after subjected to DC voltage with the rated ripple current is applied for varied hours according to varied ϕ [please refer to below sheet] at 105°C.								
	Time	ϕ	5	6.3	8	10	13	16	18
		hours	4,000	4,000	5,000	6,000	7,000	8,000	8,000
	Capacitance Change	within ±25% of Initial Value							
	tan δ	200% or less of Initial Specified Value							
Leakage Current	Initial Specified Value or less								
Shelf Life 放置壽命	The following specifications shall be satisfied when the capacitors are restored to 20°C after exposing them for 1,000 hours 105°C without voltage applied. Before the measurement, the capacitor shall be preconditioned by applying voltage according to them 4.1 of JIS C5101-4.								
	Capacitance Change	within ±25% of Initial Value							
	tan δ	200% or less of Initial Specified Value							
	Leakage Current	Initial Specified Value or less							
Standards 參照標準	JIS C 5101-4 (IEC 60384)								

HFN

Frequency Coefficient of Permissible Ripple Current

Capacitance (μF)	Frequency (Hz)			
	120	1K	10K	100K
5.6 ~ 180	0.40	0.75	0.90	1.00
220 ~ 560	0.50	0.85	0.94	1.00
680 ~ 1800	0.60	0.87	0.95	1.00
2200 ~ 3900	0.75	0.90	0.95	1.00
4700 ~ 18000	0.85	0.95	0.98	1.00

The endurance of capacitors is reduced with internal heating produced by ripple current at the rate of halving the lifetime with every 5°C rise. When long life performance is required in actual use , the rms ripple current has to be reduced.

HFN series

DIMENSIONS(mm)

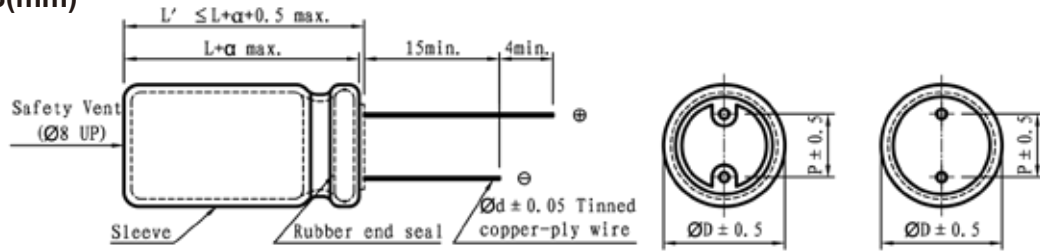

φD	5	6.3	8	10	13	16	18
P	2.0	2.5	3.5	5.0	5.0	7.5	7.5
φd	0.5	0.5	0.5	0.6	0.6	0.8	0.8

STANDARD RATINGS

D×L(mm),R.C.(mA rms) at 105°C 100KHz; IMP (Ω max)at 20°C,-10°C 100KHz.

Cap (μF)	V	D×L(mm),R.C.(mA rms) at 105°C 100KHz; IMP (Ω max)at 20°C,-10°C 100KHz.															
		Item	6.3			10			16			25					
			D x L	IMP		R.C.	D x L	IMP		R.C.	D x L	IMP		R.C.			
			20°C	-10°C		20°C	-10°C		20°C	-10°C		20°C	-10°C				
47									5x11	0.550	1.100	170	5x11	0.600	1.210	175	
100					5x11	0.550	1.100	170	6.3x11	0.290	0.550	295	6.3x11	0.310	0.610	295	
150		5x11	0.550	1.100	170								6.3x15	0.220	0.430	420	
220					6.3x11	0.270	0.550	295	6.3x15	0.190	0.400	410	8x12	0.150	0.290	650	
330		6.3x11	0.270	0.550	295	6.3x15	0.200	0.390	400	8x12	0.140	0.260	660	8x16	0.110	0.220	750
390													10x13	0.110	0.220	770	
470		6.3x15	0.200	0.400	400	8x12	0.140	0.260	650	8x20	0.096	0.180	820	8x20	0.096	0.180	820
560										8x16	0.100	0.200	740				
680		8x12	0.140	0.280	655	8x16	0.100	0.200	830	10x13	0.100	0.200	770	10x16	0.085	0.170	1060
820		10x13	0.100	0.200	860	10x13	0.100	0.200	860	10x16	0.077	0.150	1070	10x20	0.067	0.130	1230
1000		8x16	0.100	0.210	830	8x20	0.091	0.170	1010	10x20	0.061	0.120	1270	10x25	0.057	0.110	1450
1200		10x16	0.077	0.150	1250	10x16	0.077	0.150	1250	10x20	0.061	0.120	1420	10x30	0.048	0.092	1720
1500		8x20	0.094	0.190	1060	10x20	0.061	0.120	1420	10x25	0.053	0.100	1450	13x21	0.048	0.097	1670
1800		10x20	0.059	0.120	1420	10x20	0.061	0.120	1420	10x30	0.043	0.085	1700	13x25	0.040	0.076	1960
2200		10x25	0.052	0.100	1640	10x30	0.043	0.085	1930	13x21	0.045	0.087	1670	13x25	0.040	0.076	1960
2700		10x30	0.045	0.086	1930	13x21	0.045	0.088	1650	13x25	0.036	0.069	1970	13x35	0.025	0.051	2520
3300		13x21	0.044	0.086	1650	13x25	0.036	0.069	1960	13x30	0.030	0.058	2330	13x40	0.020	0.041	2860
3900		13x25	0.036	0.069	1960	13x30	0.030	0.058	2320	16x26	0.025	0.051	2570	16x26	0.025	0.051	2570
4700		13x30	0.030	0.058	2320	13x35	0.025	0.052	2520	16x32	0.023	0.045	3020	16x32	0.022	0.045	3020
5600		13x35	0.026	0.051	2520	16x32	0.022	0.041	2880	18x25	0.025	0.047	2750	18x25	0.025	0.047	2750
6300										16x40	0.019	0.036	3720	18x32	0.023	0.047	2750
6800		13x40	0.022	0.041	2880	16x36	0.022	0.041	3150	18x32	0.022	0.041	3160	18x32	0.023	0.047	2750
8200		16x26	0.028	0.051	2570	18x25	0.025	0.047	2750	18x32	0.022	0.041	3160	18x35	0.018	0.036	3810
10000		16x32	0.024	0.045	3020	18x32	0.022	0.041	3150	18x35	0.021	0.039	3670	18x35	0.018	0.036	3810
12000		16x36	0.021	0.040	3150	18x32	0.022	0.041	3150	18x40	0.020	0.035	3810				
15000		18x25	0.025	0.047	2750	18x35	0.021	0.037	3670								
18000		16x40	0.020	0.036	3720	18x35	0.021	0.037	3670								
		18x32	0.022	0.042	3340	18x40	0.020	0.036	3810								
		18x35	0.021	0.037	3670												
		18x40	0.020	0.036	3810												

※ 13mm may be replaced by 12.5mm upon customer's request.

HFN

HFN series

STANDARD RATINGS

D×L(mm) ; R.C.(mA rms) at 105°C 100KHz; IMP (Ω max)at 20°C,-10°C 100KHz.

Cap (μF)	V	35				50				63				100				
		Item	D x L	IMP		R.C.	D x L	IMP		R.C.	D x L	IMP		R.C.	D x L	IMP		R.C.
				20°C	-10°C			20°C	-10°C			20°C	-10°C			20°C	-10°C	
5.6														5x11	2.640	6.860	90	
12										5x11	2.970	6.600	145	6.3x11	1.580	4.090	120	
18														6.3x15	0.820	2.380	200	
22						5x11	1.490	2.970	165	6.3x11	1.650	3.300	250	8x12	0.720	2.110	250	
27														10x13	0.640	1.850	350	
33	5x11	0.850	1.740	185										8x16	0.480	1.300	320	
														10x16	0.450	1.200	460	
39										6.3x15	0.990	2.310	340	8x20	0.370	0.990	450	
47						6.3x11	0.720	1.490	270									
56	6.3x11	0.300	0.820	300										10x20	0.360	0.940	580	
68						6.3x15	0.520	1.060	370	8x12	0.570	1.230	410	10x25	0.270	0.700	760	
100	6.3x15	0.280	0.720	410		8x12	0.350	0.710	490	8x16	0.430	1.080	540	10x30	0.210	0.570	910	
										10x13	0.420	0.850	550	13x21	0.210	0.570	840	
120						8x16	0.270	0.530	640									
						10x13	0.250	0.530	630	10x16	0.320	0.630	620	13x25	0.160	0.430	1010	
150	8x12	0.150	0.280	625						8x20	0.350	0.850	690					
180						8x20	0.200	0.400	740									
						10x16	0.220	0.420	860	10x20	0.240	0.480	890	13x30	0.130	0.360	1220	
220	8x16	0.110	0.220	740										13x35	0.120	0.330	1420	
	10x13	0.110	0.210	770	10x20	0.150	0.300	1060	10x25	0.220	0.430	1060	16x26	0.110	0.310	1400		
270	8x20	0.099	0.200	820										13x40	0.083	0.240	1600	
330	10x16	0.085	0.170	1060		10x25	0.130	0.250	1260	10x30	0.150	0.300	1310	16x32	0.079	0.240	1740	
										13x21	0.140	0.290	1290	18x25	0.096	0.270	1610	
390						10x30	0.095	0.190	1520					16x36	0.074	0.200	1950	
						13x21	0.100	0.200	1490	13x25	0.120	0.240	1730	18x32	0.082	0.230	1820	
470	10x20	0.067	0.130	1230						13x30	0.095	0.190	2100	16x40	0.060	0.160	2100	
560	10x25	0.057	0.110	1450		13x25	0.078	0.150	1850					18x35	0.074	0.200	2150	
680	10x30	0.048	0.092	1700														
	13x21	0.050	0.096	1670	13x30	0.068	0.130	2230	13x35	0.081	0.160	2280	18x40	0.060	0.160	2250		
										16x26	0.087	0.170	2170					
820						13x35	0.060	0.110	2300	13x40	0.075	0.140	2570					
										16x32	0.075	0.146	2680					
										18x25	0.075	0.150	2690					
1000	13x25	0.040	0.076	1960		13x40	0.053	0.100	2510									
						16x26	0.062	0.120	2250	16x36	0.063	0.120	2780					
1200	13x30	0.033	0.064	2320		16x32	0.050	0.096	2710	16x36	0.054	0.100	2860					
						18x25	0.051	0.099	2610	18x32	0.059	0.110	2960					
1500	13x35	0.031	0.056	2520		16x36	0.047	0.087	2810	18x35	0.054	0.100	3120					
1800	13x40	0.023	0.045	2880		16x40	0.038	0.075	3210									
	16x26	0.031	0.057	2570		18x32	0.047	0.087	3010	18x40	0.047	0.087	3220					
2200	16x32	0.025	0.050	3020														
	18x25	0.028	0.052	2750	18x35	0.042	0.080	3110										
2700	16x36	0.024	0.044	3160														
	18x32	0.025	0.047	3340	18x40	0.038	0.071	3410										
3300	16x40	0.022	0.040	3720														
	18x35	0.023	0.041	3690														
3900	18x40	0.022	0.040	3810														

※ 13mm may be replaced by 12.5mm upon customer's request.

SGN series

- Anhydrous product.
- High ripple current, ultra low impedance at high frequency range.
- Long life.
- RoHS Compliance
- 無水系產品。
- 高紋波電流、高頻超低阻抗。
- 長壽命產品。

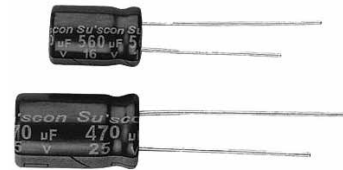

SPECIFICATIONS

Items 項目	Characteristics 特性						
Capacitance Tolerance 靜電容量誤差	± 20%(120Hz,20°C)						
Operating Temperature Range 適用溫度範圍	-55 ~ +105°C						
Rated Voltage Range 額定電壓範圍	6.3 ~ 50VDC						
Leakage Current 洩漏電流	I ≤ 0.01CV or 3 (µA) which is greater. (After 2 minutes application of DC rated voltage, at 20 °C)						
Dissipation Factor 散逸因素(tan δ)	Measurement Frequency: 120Hz. Temperature: 20°C						
	Rated Voltage(V)	6.3	10	16	25	35	50
	tan δ(Max)	0.24	0.20	0.16	0.15	0.12	0.10
When nominal capacitance over 1000µF, tanδ shall be added 0.02 to the listed value with increase of every 1000µF.							
Low Temperature Stability 低溫特性	Measurement Frequency: 120Hz.						
	Rated Voltage(V)	6.3	10	16	25	35	50
	Z(-25°C)/Z(20°C)	2	2	2	2	2	2
Impedance Ratio(Max) 阻抗比率(最大值)	Z(-55°C)/Z(20°C)	3	3	3	3	3	3
	The following specifications shall be satisfied when the capacitors are restored to 20°C after subjected to DC voltage with the rated ripple current is applied for 5,000 hours (ϕ D ≤ 6.3:2,000 hours; ϕ D = 8:3,000 hours; ϕ D = 10:4,000 hours) at 105°C.						
Load Life 負荷壽命	Capacitance Change	Within ± 25% of Initial Value					
	tan δ	200% or less of Initial Specified Value					
	Leakage Current	Initial Specified Value or less					
Shelf Life 放置壽命	The following specifications shall be satisfied when the capacitors are restored to 20°C after exposing them for 1,000 hours 105°C without voltage applied. Before the measurement, the capacitor shall be preconditioned by applying voltage according to them 4.1 of JIS C5101-4.						
	Capacitance Change	Within ± 20% of Initial Value					
	tan δ	200% or less of Initial Specified Value					
	Leakage Current	Initial Specified Value or less					
Standards 參照標準	JIS C 5101-4 (IEC 60384)						

Frequency Coefficient of Permissible Ripple Current

Capacitance (µF)	Frequency (Hz)				
	50	120	1K	10K	100K
≤ 33	0.45	0.55	0.75	0.90	1.00
47 ~ 330	0.60	0.70	0.85	0.95	1.00
470 ~ 1000	0.65	0.75	0.90	0.98	1.00
1200 ~ 6800	0.75	0.80	0.95	1.00	1.00

The endurance of capacitors is reduced with internal heating produced by ripple current at the rate of halving the lifetime with every 5°C rise. When long life performance is required in actual use , the rms ripple current has to be reduced.

SGN series

DIMENSIONS(mm)

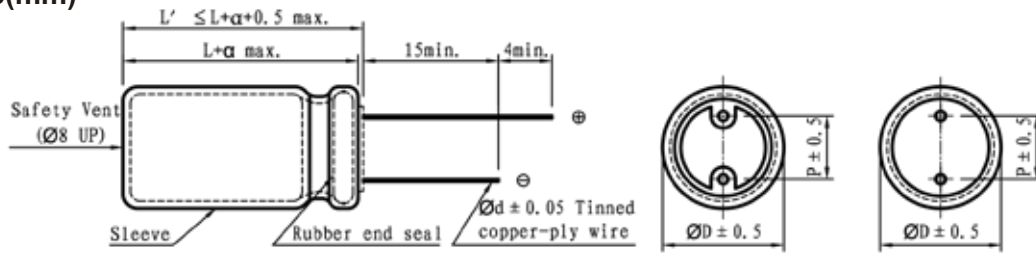

α	$(L < 16)$ 1.0
	$(L \geq 16)$ 2.0

STANDARD RATINGS

D×L(mm) ; R.C.(mA rms) at 105°C 100KHz; IMP (Ω max)at 20°C 100KHz.

Cap (μF)	V	6.3			10			16		
		Item	D x L	R.C.	IMP	D x L	R.C.	IMP	D x L	R.C.
56								5x11	250	0.500
100					5x11	250	0.500			
120								6.3x11	405	0.210
150		5x11	250	0.845						
220					6.3x11	405	0.380	8x12	700	0.210
330		6.3x11	405	0.230				8x12	760	0.120
470					8x12	760	0.210	8x16	995	0.093
560		8x12	760	0.130				10x13	1030	0.087
680					8x16	995	0.093	8x20	1250	0.068
820		8x16	995	0.099	10x13	1030	0.087	10x16	1430	0.062
1000		10x13	1030	0.093	8x20	1250	0.068			
1200					10x16	1430	0.062	10x20	1820	0.038
1500		8x20	1250	0.072	10x20	1820	0.038	10x25	2150	0.036
2200		10x16	1430	0.066						
2700		10x20	1820	0.040	10x25	2150	0.036	13x21	2360	0.035
3300		10x25	2150	0.038	13x21	2360	0.035	13x25	2770	0.030
3900								13x30	3140	0.027
4700		13x21	2360	0.037	13x25	2770	0.030	13x35	3400	0.024
5600		13x25	2770	0.032	13x30	3290	0.027	16x26	3460	0.026
6800		13x30	3290	0.027	13x35	3400	0.024			
5600		13x35	3140	0.026	16x26	3460	0.026			
6800		16x26	3460	0.027						

Cap (μF)	V	25			35			50		
		Item	D x L	R.C.	IMP	D x L	R.C.	IMP	D x L	R.C.
22								5x11	238	1.310
33					5x11	250	0.330			
47		5x11	250	0.500				6.3x11	385	1.140
56					6.3x11	405	0.230	6.3x11	385	0.540
68										
100		6.3x11	405	0.380				8x12	724	0.340
120								8x16	950	0.230
150					8x12	760	0.130	10x13	979	0.230
180								8x20	1190	0.180
220		8x12	760	0.150	8x16	995	0.099	10x16	1370	0.160
270					10x13	1030	0.093			
330		8x16	995	0.093	8x20	1250	0.100	10x20	1580	0.120
470		10x13	1030	0.087	10x16	1430	0.100	10x25	1870	0.110
560		8x20	1250	0.068	10x20	1820	0.085	13x21	2050	0.110
680		10x16	1430	0.062						
820					10x25	2150	0.053	13x25	2410	0.088
1000		10x20	1820	0.058	13x21	2360	0.051	13x30	2860	0.081
1200		10x25	2150	0.036	13x21	2450	0.048	13x35	2960	0.074
1500		13x21	2360	0.035	13x25	2770	0.044	16x26	3010	0.081
1800					13x30	3140	0.037			
2200		13x25	2770	0.030	13x35	3400	0.035			
2700		13x30	3140	0.026	16x26	3460	0.037			
3300		13x35	3400	0.024						
3900		16x26	3460	0.026						

※ 13mm may be replaced by 12.5mm upon customer's request.

HGN series

- Anhydrous product.
- High ripple current, Low impedance at high frequency range.
- 105°C, long life 10000hours.
- RoHS Compliance
- 無水系產品。
- 高紋波電流、高頻低阻抗。
- 105°C 10000小時長壽命產品。

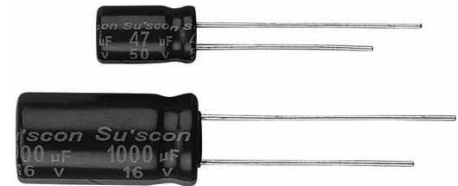

SPECIFICATIONS

Items 項目	Characteristics 特性									
Capacitance Tolerance 靜電容量誤差	± 20%(120Hz,20°C)									
Operating Temperature Range 適用溫度範圍	-55 ~ +105°C					-40 ~ +105°C				
Rated Voltage Range 額定電壓範圍	6.3 ~ 50VDC					63 ~ 100VDC				
Leakage Current 洩漏電流	I ≤ 0.01CV or 3 (µA) which is greater.(After 2 minutes application of DC rated voltage, at 20 °C)									
Dissipation Factor 散逸因素(tan δ)	Measurement Frequency: 120Hz. Temperature: 20°C									
	Rated Voltage(V)	6.3	10	16	25	35	50	63~80	100	
	tan δ(Max)	0.24	0.20	0.16	0.15	0.12	0.10	0.09	0.08	
When nominal capacitance over 1000µF, tanδ shall be added 0.02 to the listed value with increase of every 1000µF.										
Low Temperature Stability 低溫特性 Impedance Ratio(Max) 阻抗比率(最大值)	Measurement Frequency: 120Hz.									
	Rated Voltage(V)	6.3	10	16	25	35	50	63	100	
	Z(-25°C)/Z(20°C)	4	3	2	2	2	2	2	2	
	Z(-40°C)/Z(20°C)	-	-	-	-	-	-	3	3	
Z(-55°C)/Z(20°C)	8	6	4	3	3	3	3	3		
Load Life 負荷壽命	The following specifications shall be satisfied when the capacitors are restored to 20°C after subjected to DC voltage with the rated ripple current is applied for varied hours according to varied φ and voltage [please refer to below sheet] at 105°C.									
	Case size			φ D ≤ 6.3		φ D = 8,10		φ D ≥ 13		
	Voltage	6.3 ~ 10 V		4,000 hours		6,000 hours		8,000 hours		
		16 ~ 100 V		5,000 hours		7,000 hours		10,000 hours		
	Capacitance Change		Within ± 25% of Initial Value							
	tan δ		200% or less of Initial Specified Value							
Leakage Current		Initial Specified Value or less								
Shelf Life 放置壽命	The following specifications shall be satisfied when the capacitors are restored to 20°C after exposing t14be preconditioned by applying voltage according to them 4.1 of JIS C5101-4.									
	Capacitance Change		Within ± 25% of Initial Value							
	tan δ		200% or less of Initial Specified Value							
	Leakage Current		Initial Specified Value or less							
Standards 參照標準	JIS C 5101-4 (IEC 60384)									

Frequency Coefficient of Permissible Ripple Current

Capacitance (µF)	Frequency (Hz)				
	50	120	300	1K	100K
≤ 33	0.50	0.55	0.70	0.90	1.00
47 ~ 330	0.60	0.70	0.85	0.95	1.00
470 ~ 1000	0.65	0.75	0.90	0.98	1.00
1200 ~ 18000	0.70	0.80	0.95	1.00	1.00

The endurance of capacitors is reduced with internal heating produced by ripple current at the rate of halving the lifetime with every 5°C rise. When long life performance is required in actual use , the rms ripple current has to be reduced.

HGN series

DIMENSIONS(mm)

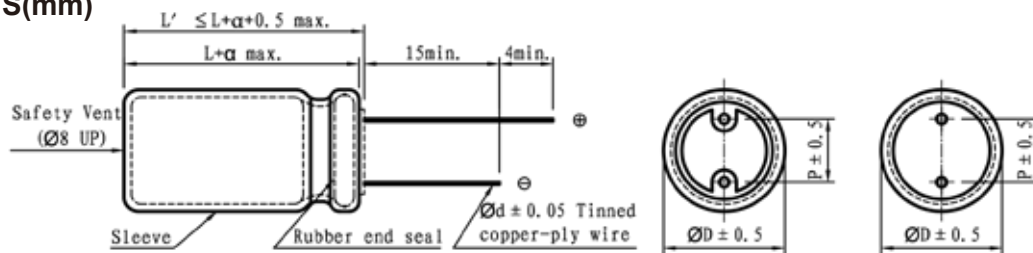

STANDARD RATINGS

D×L(mm) ; R.C.(mA rms) at 105°C 100KHz; IMP (Ω max)at 20°C,-10°C 100KHz

Cap (µF)	V	Item	6.3			10				
			D x L	IMP		R.C.	D x L	IMP		R.C.
				20°C	-10°C			20°C	-10°C	
100						5x11	0.640	2.530	215	
150		5x11	0.630	2.530	210	5x11	0.640	2.530	230	
220		6.3x11	0.280	0.990	320	6.3x11	0.250	0.960	340	
330		6.3x11	0.230	0.960	340	6.3x11	0.250	0.960	380	
470		8x12	0.170	0.640	345	8x12	0.150	0.580	640	
680		8x12	0.150	0.580	645	8x16	0.098	0.390	845	
						10x13	0.091	0.340	865	
820		10x13	0.091	0.360	865	10x16	0.080	0.310	1015	
1000		8x16	0.097	0.390	870	8x20	0.078	0.300	1050	
						10x16	0.069	0.270	1215	
1200		8x20	0.081	0.290	1050	10x20	0.053	0.200	1410	
		10x16	0.072	0.270	1215					
1500		10x20	0.053	0.210	1410	10x25	0.048	0.190	1610	
1800						13x21	0.046	0.170	1710	
2200		10x25	0.050	0.190	1650	10x30	0.036	0.140	1920	
						13x21	0.042	0.140	1910	
2700		10x30	0.036	0.140	1900					
3300		13x21	0.041	0.140	1900	13x25	0.032	0.100	2230	
3900		13x25	0.032	0.100	2240	13x30	0.029	0.089	2660	
4700		13x30	0.029	0.089	2650	13x35	0.025	0.075	2890	
5600		13x35	0.025	0.075	2890	13x40	0.021	0.064	3360	
						16x26	0.025	0.069	2940	
6800		13x40	0.021	0.064	3350	16x32	0.021	0.058	3460	
		16x26	0.025	0.069	2940	18x25	0.025	0.057	3150	
8200		16x32	0.021	0.058	3450	16x36	0.020	0.052	3610	
						18x32	0.020	0.047	4180	
10000		16x36	0.019	0.052	3620	16x40	0.018	0.045	4090	
		18x25	0.023	0.057	3150	18x35	0.017	0.045	4150	
12000		16x40	0.017	0.045	4090	18x40	0.015	0.039	4290	
		18x32	0.019	0.047	4180					
15000		18x35	0.018	0.045	4230					
18000		18x40	0.016	0.035	4290					

※ 13mm may be replaced by 12.5mm upon customer's request.

HGN

HGN series

STANDARD RATINGS

D×L(mm) ; R.C.(mA rms) at 105°C 100KHz; IMP (Ω max)at 20°C, -10°C 100KHz

Cap (μF)	V Item	16				25			
		D x L	IMP		R.C.	D x L	IMP		R.C.
			20°C	-10°C			20°C	-10°C	
47						5x11	0.760	3.040	200
56		5x11	0.760	3.040	220	5x11	0.760	3.040	240
100		6.3x11	0.280	1.150	310	6.3x11	0.280	1.150	340
120		6.3x11	0.280	1.150	340				
220		8x12	0.250	1.130	510	8x12	0.160	0.690	650
330		8x12	0.160	0.690	650	8x16	0.120	0.470	850
	10x13					0.110	0.430	870	
470		8x16	0.120	0.470	840	8x20	0.096	0.360	1050
		10x13	0.110	0.430	865	10x16	0.083	0.320	1210
680		8x20	0.095	0.360	1060	10x20	0.064	0.240	1410
		10x16	0.083	0.320	1210				
820		10x20	0.073	0.290	1310	10x25	0.058	0.230	1660
1000		10x20	0.064	0.240	1410	10x30	0.043	0.160	1920
	13x21					0.049	0.160	1910	
1200		10x25	0.061	0.230	1650				
1500		10x30	0.043	0.160	1920	13x25	0.038	0.120	2240
		13x21	0.050	0.160	1910				
1800		13x25	0.041	0.130	2140	13x30	0.036	0.110	2660
2200		13x25	0.038	0.120	2240	13x35	0.030	0.090	2890
2700		13x30	0.035	0.110	2650	13x40	0.025	0.078	3360
	16x26					0.031	0.083	2940	
3300		13x35	0.030	0.091	2890	16x32	0.025	0.070	3460
	18x25					0.028	0.067	3150	
3900		13x40	0.031	0.078	3350	18x25	0.023	0.061	3620
		16x26	0.028	0.083	2930	18x32	0.024	0.056	4180
4700		16x32	0.025	0.070	3450	16x40	0.020	0.054	4090
		18x25	0.028	0.068	3150	18x35	0.022	0.054	4230
5600		16x36	0.024	0.062	3620	18x40	0.018	0.047	4290
		18x32	0.024	0.056	4180				
6800		16x40	0.020	0.054	4080				
8200		18x35	0.023	0.054	4230				
10000		18x40	0.018	0.047	4290				

※ 13mm may be replaced by 12.5mm upon customer's request.

HGN series

STANDARD RATINGS

D×L(mm) ; R.C.(mA rms) at 105°C 100KHz; IMP (Ω max)at 20°C,-10°C 100KHz

Cap (μF)	V Item	35				50			
		D x L	IMP		R.C.	D x L	IMP		R.C.
			20°C	-10°C			20°C	-10°C	
22						5x11	1.540	6.16	180
33		5x11	0.690	2.780	220				
47		6.3x11	0.430	1.700	280	6.3x11	0.780	3.300	220
56		6.3x11	0.400	1.580	340	6.3x11	0.660	2.640	300
100		8x12	0.320	1.180	510	8x12	0.360	1.470	560
120						8x16	0.270	1.060	740
150		8x12	0.160	0.630	650	10x13	0.270	1.060	770
180						8x20	0.200	0.800	920
220		8x16	0.110	0.430	850	10x16	0.190	0.750	1050
		10x13	0.100	0.390	865				
270		8x20	0.088	0.320	1060	10x20	0.140	0.530	1230
330		10x16	0.076	0.290	1210	10x25	0.120	0.490	1450
470		10x20	0.058	0.220	1410	10x30	0.100	0.380	1695
	13x21					0.100	0.340	1670	
560		10x25	0.053	0.200	1650	13x25	0.080	0.250	1950
680		10x30	0.040	0.150	1920	13x30	0.072	0.230	2320
		13x21	0.044	0.160	1910				
820						13x35	0.058	0.180	2520
1000		13x25	0.037	0.110	2230	13x40	0.050	0.160	2930
						16x26	0.062	0.170	2555
1200		13x30	0.032	0.098	2660	16x32	0.052	0.150	3020
						18x25	0.062	0.160	2750
1500		13x35	0.028	0.083	2880	16x36	0.046	0.130	3150
1800		13x40	0.023	0.072	3350	16x40	0.042	0.110	3720
		16x26	0.028	0.076	2940	18x32	0.052	0.130	3640
2200		16x32	0.023	0.064	3500	18x35	0.044	0.100	3690
		18x25	0.026	0.063	3140				
2700		16x36	0.022	0.057	3620	18x40	0.038	0.090	3810
		18x32	0.021	0.052	4180				
3300		16x40	0.020	0.050	4090				
		18x35	0.021	0.050	4230				
3900		18x40	0.019	0.044	4290				

※ 13mm may be replaced by 12.5mm upon customer's request.

HGN series

STANDARD RATINGS

D×L(mm) ; R.C.(mA rms) at 105°C 100KHz; IMP (Ω max)at 20°C,-10°C 100KHz

Cap (μF)	V Item	63			100				
		D x L	IMP		R.C.	D x L	IMP		
			20°C	-10°C			20°C	-10°C	
6.8					5x11	2.780	11.640	56	
15		5x11	2.20	9.20	56	6.3x11	1.520	6.330	120
27						8x12	0.980	4.390	235
33		6.3x11	1.20	5.00	120				
39						8x16	0.570	2.660	280
47		8x12	0.68	3.10	190	10x13	0.550	2.280	290
56		8x12	0.62	2.80	235	8x20	0.410	2.020	330
68						10x16	0.380	1.900	358
82		8x16	0.45	2.10	310	10x20	0.270	1.190	470
		10x13	0.43	1.80	300				
100		10x16	0.35	1.80	320	10x25	0.260	1.070	536
120		8x20	0.33	1.60	362	10x30	0.190	0.900	666
		10x16	0.30	1.50	357	13x21	0.210	0.810	690
180		10x20	0.20	0.94	470	13x25	0.160	0.570	790
220		10x25	0.20	0.84	531	13x30	0.130	0.530	905
	16x22					0.120	0.470	1050	
270		10x30	0.15	0.70	663	13x35	0.110	0.450	1060
		13x21	0.13	0.65	690	16x26	0.095	0.340	1250
330		13x25	0.12	0.45	790	13x40	0.092	0.380	1190
390						16x32	0.071	0.260	1570
						18x25	0.075	0.270	1490
470		13x30	0.100	0.42	910	16x36	0.061	0.220	1790
	18x32					0.063	0.220	1640	
560		13x35	0.082	0.35	1050	16x40	0.054	0.190	2030
		16x26	0.073	0.27	1250				
680		13x40	0.070	0.30	1190	18x35	0.054	0.190	1790
820		16x32	0.053	0.20	1580	18x40	0.049	0.170	2340
		18x25	0.057	0.21	1490				
1000		16x36	0.045	0.17	1790				
		18x32	0.047	0.17	1640				
1200		16x40	0.039	0.15	2020				
		18x35	0.040	0.15	1790				
1500		18x40	0.035	0.13	2340				

※ 13mm may be replaced by 12.5mm upon customer's request.

SEN series

- Anhydrous product.
- 105°C high-temperature, high reliability and long life.
- Suitable for office communicative and industrial equipments.
- RoHS Compliance
- 無水系產品。
- 105°C 耐高溫、高信賴性長壽命製品。
- 適用於辦公室通訊設備、工業設備。



SPECIFICATIONS

Items 項目	Characteristics 特性					
Capacitance Tolerance 靜電容量誤差	± 20%(120Hz,20°C)					
Operating Temperature Range 適用溫度範圍	-40 ~ +105°C					
Rated Voltage Range 額定電壓範圍	160 ~ 450VDC					
Leakage Current 洩漏電流	$I \leq 0.03CV + 20 (\mu A)$ (After 3 minutes application of DC rated voltage, at 20 °C)					
Dissipation Factor 散逸因素(tan δ)	Measurement Frequency: 120Hz. Temperature: 20°C					
	Rated Voltage(V)	160	200	250	350	400~450
	tan δ(Max)	0.20	0.20	0.20	0.25	0.25
When nominal capacitance over 1000µF, tanδ shall be added 0.02 to the listed value with increase of every 1000µF.						
Low Temperature Stability 低溫特性 Impedance Ratio(Max) 阻抗比率(最大值)	Measurement Frequency: 120Hz.					
	Rated Voltage(V)	160	200	250	350	400
	Z(-25°C)/Z(20°C)	3	3	3	6	15
Load Life 負荷壽命	The following specifications shall be satisfied when the capacitors are restored to 20°C after subjected to DC voltage with the rated ripple current is applied for 5,000 hours (φ D≤8:3,000 hours; φ D=10:4,000 hours) at 105°C.					
	Capacitance Change	Within ± 25% of Initial Value				
	tan δ	200% or less of Initial Specified Value				
	Leakage Current	Initial Specified Value or less				
Shelf Life 放置壽命	The following specifications shall be satisfied when the capacitors are restored to 20°C after exposing them for 1,000 hours 105°C without voltage applied. Before the measurement, the capacitor shall be preconditioned by applying voltage according to them 4.1 of JIS C5101-4.					
	Capacitance Change	Within ± 20% of Initial Value				
	tan δ	200% or less of Initial Specified Value				
	Leakage Current	Initial Specified Value or less				
Standards 參照標準	JIS C 5101-4 (IEC 60384)					

Frequency Coefficient of Permissible Ripple Current

Rated Voltage (V)	Capacitance (µF)	Frequency (Hz)			
		50	120	1K	≥ 10K
≥ 160	2.2 ~ 220	0.80	1.00	1.30	1.40

The endurance of capacitors is reduced with internal heating produced by ripple current at the rate of halving the lifetime with every 5°C rise. When long life performance is required in actual use , the rms ripple current has to be reduced.

SEN series

DIMENSIONS(mm)

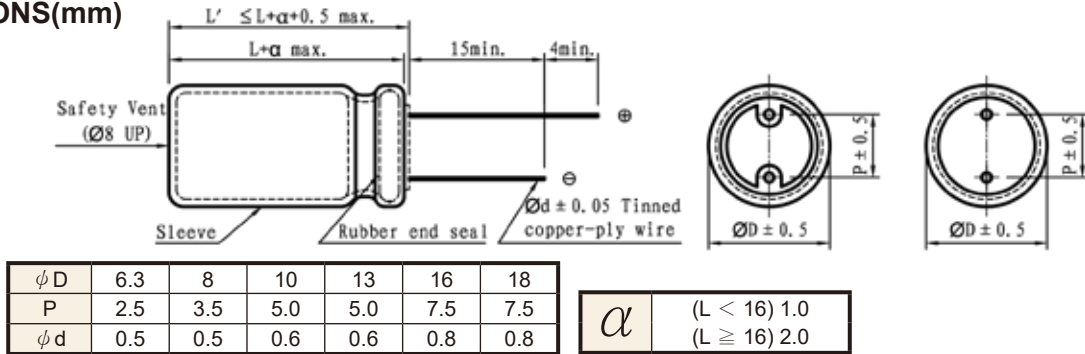

STANDARD RATINGS

D x L (mm) ; R.C. (mA rms) at 105°C 120Hz

Cap (μF)	V	160		200		250		400		450		
		Item	D x L	R.C.	D x L	R.C.	D x L	R.C.	D x L	R.C.	D x L	R.C.
2.2			6.3x11	29	6.3x11	29	8x12	36	8x12	36	8x12	36
3.3			8x12	35	8x12	36	8x12	52	8x12	45	8x12	52
4.7			8x12	44	8x12	52	8x12	57	10x13	57	10x13	62
10			10x13	78	10x16	83	10x16	104	10x20	95	10x20	104
22			10x16	135	10x20	145	13x21	176	13x21	168	13x25	197
33			10x20	176	13x21	208	13x21	234	13x25	213	16x22	249
39			10x20	197	13x21	228	13x25	260	16x22	213	16x26	312
47			13x21	239	13x21	260	13x25	291	16x26	332	16x32	343
68			13x25	270	13x25	291	16x22	322	16x26	364	18x25	364
82			16x22	332	16x26	364	16x32	405	18x25	436	18x32	603
100			16x26	364	16x32	499	16x36	520	18x32	572	18x35	686
120									18x40	676	18x40	800

※ 13mm may be replaced by 12.5mm upon customer's request.

LX series

- Snap-in type, 85°C 2000 hours standard product.
- Suitable for filter circuit of home appliance, e.g. TV set, audio, etc.
- RoHS Compliance
- 基板自立 85°C 2000小時標準品。
- 適用於家電產品輸入/輸出電源的濾波迴路，如電視機、音響等。



SPECIFICATIONS

Items 項目	Characteristics 特性							
Capacitance Tolerance 靜電容量誤差	± 20%(120Hz,20°C)							
Operating Temperature Range 適用溫度範圍	-40 ~ +85°C				-25 ~ +85°C			
Rated Voltage Range 額定電壓範圍	10 ~ 100VDC				160 ~ 500VDC			
Leakage Current 洩漏電流	$I \leq 3\sqrt{CV}$ (µA) (After 5 minutes application of DC rated voltage, at 20 °C)							
Dissipation Factor 散逸因素(tan δ)	Measurement Frequency: 120Hz. Temperature: 20°C							
	Rated Voltage(V)	10	16	25	35	50~80	100~250	330~500
	tan δ(Max)	0.50	0.40	0.35	0.30	0.25	0.20	0.25
When nominal capacitance over 1000µF, tanδ shall be added 0.01 to the listed value with increase of every 1000µF.								
Low Temperature Stability 低溫特性 Impedance Ratio(Max) 阻抗比率(最大值)	Measurement Frequency: 120Hz.							
	Rated Voltage(V)	10~100		160~250		350~500		
	Z(-25°C)/Z(20°C)	4		4		8		
Z(-40°C)/Z(20°C)	12		15					
Load Life 負荷壽命	The following specifications shall be satisfied when the capacitors are restored to 20°C after subjected to DC voltage with the rated ripple current is applied for 2,000 hours at 85°C.							
	Capacitance Change	Within ± 20% of Initial Value						
	tan δ	200% or less of Initial Specified Value						
	Leakage Current	Initial Specified Value or less						
Shelf Life 放置壽命	The following specifications shall be satisfied when the capacitors are restored to 20°C after exposing them for 1,000 hours 85°C without voltage applied. Before the measurement, the capacitor shall be preconditioned by applying voltage according to them 4.1 of JIS C5101-4.							
	Capacitance Change	Within ± 20% of Initial Value						
	tan δ	150% or less of Initial Specified Value						
	Leakage Current	Initial Specified Value or less						
Standards 參照標準	JIS C 5101-4 (IEC 60384)							

Frequency Coefficient of Permissible Ripple Current

Rated Voltage (V)	Frequency (Hz)			
	50	120	1K	≥10K
10 ~ 100	0.88	1.00	1.15	1.15
160 ~ 250	0.85	1.00	1.15	1.20
350 ~ 500	0.88	1.00	1.10	1.15

The endurance of capacitors is reduced with internal heating produced by ripple current at the rate of halving the lifetime with every 10°C rise. When long life performance is required in actual use , the rms ripple current has to be reduced.



LX series

DIMENSIONS(mm)

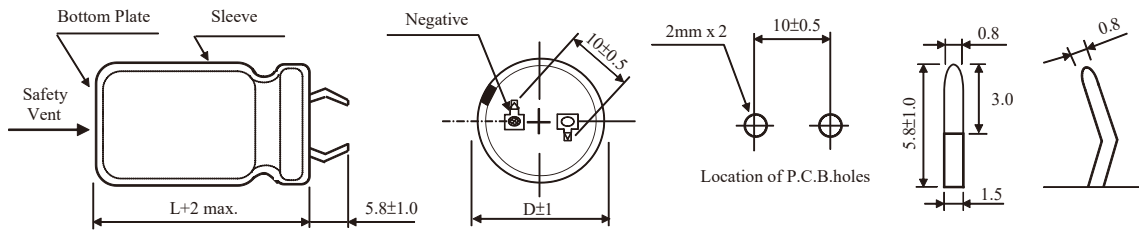

STANDARD RATINGS

D×L(mm) ; R.C.(A rms) at 85°C 120Hz

Cap (μF)	V	10		16		25		35		50		63		80	
		Item	D x L	R.C.	D x L	R.C.	D x L	R.C.	D x L	R.C.	D x L	R.C.	D x L	R.C.	D x L
820														22x25	1.34
1000												22x25	1.52	22x25	1.64
1500												22x25	1.68	22x30 25x25	1.80
2200										22x25	2.08	22x30 25x25	2.58	22x35 25x30	2.65
2700										22x30	2.32	22x35 25x30	2.80	22x40 25x30	2.82
3300										22x30 25x25	2.65	22x40 25x30	2.88	22x45 25x40	3.30
3900								22x25	2.44	22x35 25x30	2.72	22x45 25x35	3.15	25x45 30x35	3.40
4700						22x25	2.49	22x30 25x25	2.64	22x40 25x35	3.09	22x50 25x40	3.39	25x50 30x40	3.62
6800				22x25	2.40	22x30 25x25	2.57	22x40 25x30	2.81	22x50 25x40	3.86	25x50 30x40	4.34	30x50 35x40	4.68
8200				22x25	2.90	22x35 25x25	2.96	22x45 25x35	3.12	25x50 30x40	4.42	30x45 35x35	4.84	35x45	4.96
10000		22x25	2.08	22x30	3.08	22x40 25x30	3.40	22x50 25x40	3.55	25x50 30x40	4.98	35x40	5.51	35x50	6.08
12000		22x25	2.40	22x30 25x25	3.50	22x45 25x35	3.61	25x45 30x35	4.02	30x50 35x35	5.16	35x50	6.22		
15000		22x30	2.76	22x35 25x30	3.95	25x45 30x35	4.10	30x40 35x35	5.01	35x45	6.45				
18000		22x35 25x25	3.14	22x40 25x35	4.40	25x45 30x35	4.47	30x45 35x40	5.55	35x50	6.72				
22000		22x40 25x30	3.53	22x50 25x40	4.71	25x50 30x45	5.22	35x45	6.02						
27000		22x45 25x35	4.18	25x45 30x35	5.51	30x50 35x40	6.02	35x50	6.85						
33000		22x50 25x40	5.21	25x50 30x40	5.82	35x45	6.78	35x45	6.95						
39000		25x45 30x35	5.30	30x45 35x35	6.36	35x45	7.60	35x50	7.16						
47000		30x40	5.98	30x50 35x40	6.99	35x50	7.88								
56000		30x45	6.60	35x45	7.17										
68000		35x40	7.28	35x50	10.10										

LX series

STANDARD RATINGS

D×L(mm) ; R.C.(A rms) at 85°C 120Hz

Cap (μF)	V Item	100		160		200		250		350		400		450		500	
		D x L	R.C.	D x L	R.C.	D x L	R.C.	D x L	R.C.	D x L	R.C.	D x L	R.C.	D x L	R.C.	D x L	R.C.
47												22x25	0.42	22x25	0.46	22x35	0.47
100										22x25	0.77	22x30 25x25	1.05	22x35 25x25	1.10	25x40	1.13
120										22x30 25x25	0.93	22x35 25x25	1.15	22x40 25x30	1.21	25x45	1.25
150							22x25	1.10	22x35 25x30	1.16	22x40 25x30	1.25	22x45 25x35	1.44	25x50 30x35	1.50 1.48	
220				22x20	1.12	22x25 25x20	1.37	22x30 25x25	1.44	22x45 25x35	1.47	22x50 25x40	1.76	25x45 30x40	1.77	30x45	1.78
330				22x25 25x20	1.45	22x30 25x25	1.88	22x35 25x30	1.93	25x50 30x40	1.99	30x40 35x30	2.30	30x45 35x40	2.79	35x45	2.81
470				22x30 25x25	1.83	22x40 25x30	2.25	22x45 25x35	2.39	30x50 35x40	2.44	35x45	2.82	35x50	2.92	35x60	3.00
560				22x35 25x30	2.03	22x40 25x30	2.57	25x40 30x35	2.81	35x45	3.29	35x50	3.36	35x55	3.15	35x60	3.03
680	22x25	1.54	22x35 25x30	2.37	22x50 25x40	2.84	25x50 30x40	3.22	35x50	3.44	35x50	3.50	35x60	3.36	35x70	3.27	
820	22x25 25x20	1.88	22x40 25x35	2.75	25x45 30x35	3.35	30x45 35x40	3.51	35x50	3.58	35x60	3.83	35x65	3.59	40x70	3.76	
1000	22x30 25x25	1.94	25x40 30x35	3.22	25x50 30x40	3.79	30x50 35x45	3.94	35x55	3.89	35x65	4.20	35x70	3.81	45x80	4.21	
1200	22x30 25x25	2.11	25x40 30x35	3.41	25x50 30x40	4.08	30x50 35x45	4.45	35x60	4.17	35x70	4.41	40x70	4.01	45x90	4.50	
1500	22x35 25x30	2.47	30x45 35x35	3.96	30x50 35x40	5.02	35x50	5.36	35x65	4.56	40x70	4.52	45x70	4.13	45x100	4.80	
2200	22x45 25x40	3.15	35x45	4.68	35x50	6.09	40x60	6.13	45x75	5.75	45x85	5.64	45x100	5.22			
2700	25x45 30x35	3.72	35x50	5.35													
3300	25x50 30x40	4.06															
3900	30x45 35x35	4.55															
4700	30x50 35x40	5.12															
6800	35x50	5.85															



LXB series

- Long life of LX series.
- Suitable for filter circuit of home appliance, e.g. TV set, audio, etc.
- RoHS Compliance
- LX系列壽命提升品
- 適用於家電產品輸入/輸出電源的濾波迴路, 如電視機、音響等。



SPECIFICATIONS

Items 項目	Characteristics 特性							
Capacitance Tolerance 靜電容量誤差	±20% (120Hz, 20°C)							
Operating Temperature Range 適用溫度範圍	- 40 ~ +85°C				- 25 ~ +85°C			
Rated Voltage Range 額定電壓範圍	10~ 100VDC				160~ 550VDC			
Leakage Current 洩漏電流	$I \leq 3\sqrt{CV}$ (µA) (After 5 minutes application of DC rated voltage, at 20 °C)							
Dissipation Factor 散逸因素 (tan δ)	Measurement Frequency: 120Hz. Temperature: 20°C							
	Rated Voltage(V)	10	16	25	35	50~100	160~250	330~500
	tan δ(Max)	0.50	0.40	0.35	0.30	0.25	0.20	0.25
When nominal capacitance over 1000µF, tanδ shall be added 0.02 to the listed value with increase of every 1000µF.								
Low Temperature Stability 低溫特性 Impedance Ratio(Max) 阻抗比率(最大值)	Measurement Frequency: 120Hz							
	Rated Voltage(V)	10~100		160~250		330~500		
	Z(-25°C)/Z(20°C)	4		4		8		
	Z(-40°C)/Z(20°C)	12		15		-		
Load Life 負荷壽命	The following specifications shall be satisfied when the capacitors are restored to 20°C after subjected to DC voltage with the rated ripple current is applied for 3,000 hours at 85°C.							
	Capacitance Change	within ±20% of Initial Value						
	tan δ	200% or less of Initial Specified Value						
	Leakage Current	Initial Specified Value or less						
Shelf Life 放置壽命	The following specifications shall be satisfied when the capacitors are restored to 20°C after exposing them for 1000hours 85°C without voltage applied. Before the measurement. The Capacitance shall be preconditioned by applying voltage according to them 4.1 of JIS C5101-4.							
	Capacitance Change	within ±20% of Initial Value						
	tan δ	150% or less of Initial Specified Value						
	Leakage Current	Initial Specified Value or less						
Standards 參照標準	JIS C 5101-4-1 (IEC 60384)							

Frequency Coefficient of Permissible Ripple Current

Rated Voltage (V)	Frequency (Hz)			
	50	120	1K	≥10K
10 ~ 100	0.88	1.00	1.15	1.15
160 ~ 250	0.85	1.00	1.15	1.20
330 ~ 550	0.88	1.00	1.10	1.15

The endurance of capacitors is reduced with internal heating produced by ripple current at the rate of halving the lifetime with every 10°C rise. When long life performance is required in actual use. The rms ripple current has to be reduced.

LXB series

DIMENSIONS(mm)

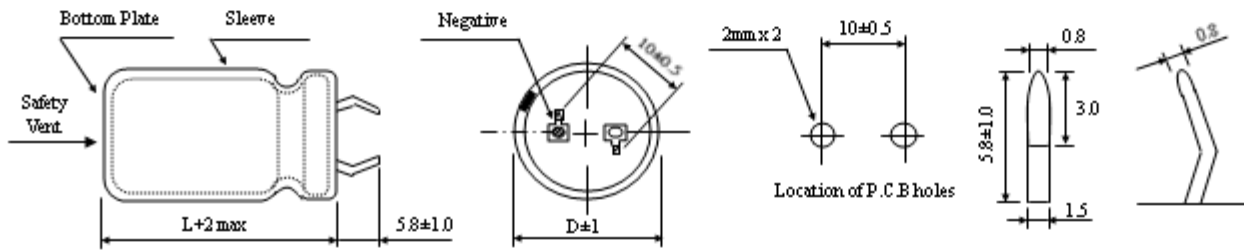

STANDARD RATINGS

DxL(mm), R.C : (A rms) at 85°C 120 Hz

Cap (μF)	V Item	10		16		25		35		50		63		80	
		D x L	R.C.	D x L	R.C.	D x L	R.C.	D x L	R.C.	D x L	R.C.	D x L	R.C.	D x L	R.C.
820														22x25	1.35
1000												22x25	1.54	22x25	1.66
1500												22x25	1.70	22x30 25x25	1.82
2200										22x25	2.10	22x30 25x25	2.61	22x35 25x30	2.68
2700										22x30	2.34	22x35 25x30	2.83	22x40 25x30	2.85
3300										22x30 25x25	2.68	22x40 25x30	2.91	22x45 25x40	3.33
3900								22x25	2.46	22x35 25x30	2.75	22x45 25x35	3.18	25x45 30x35	3.43
4700						22x25	2.51	22x30 25x25	2.67	22x40 25x35	3.12	22x50 25x40	3.42	25x50 30x40	3.66
6800				22x25	2.42	22x30 25x25	2.60	22x40 25x30	2.84	22x50 25x40	3.90	25x50 30x40	4.38	30x50 35x40	4.73
8200				22x25	2.93	22x35 25x25	2.99	22x45 25x35	3.15	25x50 30x40	4.46	30x45 35x35	4.89	35x45	5.01
10000	22x25	2.10	22x30	3.11	22x40 25x30	3.43	22x50 25x40	3.59	25x50 30x40	5.03	35x40	5.57	35x50	6.14	
12000	22x25	2.42	22x30 25x25	3.54	22x45 25x35	3.65	25x45 30x35	4.06	30x50 35x35	5.21	35x50	6.28			
15000	22x30	2.79	22x35 25x30	3.99	25x45 30x35	4.14	30x40 35x35	5.06	35x45	6.51					
18000	22x35 25x25	3.17	22x40 25x35	4.44	25x45 30x35	4.51	30x45 35x40	5.61	35x50	6.79					
22000	22x40 25x30	3.57	22x50 25x40	4.76	25x50 30x45	5.27	35x45	6.08							
27000	22x45 25x35	4.22	25x45 30x35	5.57	30x50 35x40	6.08	35x50	6.92							
33000	22x50 25x40	5.26	25x50 30x40	5.88	35x45	6.85	35x45	7.02							
39000	25x45 30x35	5.35	30x45 35x35	6.42	35x45	7.68	35x50	7.23							
47000	30x40	6.04	30x50 35x40	7.06	35x50	7.96									
56000	30x45	6.67	35x45	7.24											
68000	35x40	7.35	35x50	10.20											

LXB series

STANDARD RATINGS

Cap (μ F)	V	100		160		200		250		350		400		450		500	
	Item	D x L	R.C.	D x L	R.C.	D x L	R.C.	D x L	R.C.	D x L	R.C.	D x L	R.C.	D x L	R.C.	D x L	R.C.
47												22x25	0.42	22x25	0.46	22x35	0.47
100										22x25	0.78	22x30 25x25	1.06	22x35 25x25	1.11	25x40	1.14
120										22x30 25x25	0.94	22x35 25x25	1.16	22x40 25x30	1.22	25x45	1.26
150								22x25	1.11	22x35 25x30	1.17	22x40 25x30	1.26	22x45 25x35	1.45	25x50 30x35	1.52 1.49
220				22x20	1.13	22x25 25x20	1.38	22x30 25x25	1.45	22x45 25x35	1.48	22x50 25x40	1.78	25x45 30x40	1.79	30x45	1.80
330				22x25 25x20	1.46	22x30 25x25	1.90	22x35 25x30	1.95	25x50 30x40	2.01	30x40 35x30	2.32	30x45 35x40	2.82	35x45	2.84
470				22x30 25x25	1.85	22x40 25x30	2.27	22x45 25x35	2.41	30x50 35x40	2.46	35x45	2.85	35x50	2.95	35x60	3.03
560				22x35 25x30	2.05	22x40 25x30	2.60	25x40 30x35	2.84	35x45	3.32	35x50	3.39	35x55	3.18	35x60	3.06
680	22x25	1.56	22x35 25x30	2.39	22x50 25x40	2.87	25x50 30x40	3.25	35x50	3.47	35x50	3.54	35x60	3.39	35x70	3.30	
820	22x25 25x20	1.90	22x40 25x35	2.78	25x45 30x35	3.38	30x45 35x40	3.55	35x50	3.62	35x60	3.87	35x65	3.63	40x70	3.80	
1000	22x30 25x25	1.96	25x40 30x35	3.25	25x50 30x40	3.83	30x50 35x45	3.98	35x55	3.93	35x65	4.24	35x70	3.85	45x80	4.25	
1200	22x30 25x25	2.13	25x40 30x35	3.44	25x50 30x40	4.12	30x50 35x45	4.49	35x60	4.21	35x70	4.45	40x70	4.05	45x90	4.55	
1500	22x35 25x30	2.49	30x45 35x35	4.00	30x50 35x40	5.07	35x50	5.41	35x65	4.61	40x70	4.57	45x70	4.17	45x100	4.85	
2200	22x45 25x40	3.18	35x45	4.73	35x50	6.15	40x60	6.19	45x75	5.81	45x85	5.70	45x100	5.27			
2700	25x45 30x35	3.76	35x50	5.40													
3300	25x50 30x40	4.10															
3900	30x45 35x35	4.60															
4700	30x50 35x40	5.17															
6800	35x50	5.91															

LXA series

- Long life of LX series.
- Suitable for filter circuit of home appliance, e.g. TV set, audio, etc.
- RoHS Compliance
- LX系列壽命提升品
- 適用於家電產品輸入/輸出電源的濾波迴路,如電視機、音響等。



SPECIFICATIONS

Items 項目	Characteristics 特性							
Capacitance Tolerance 靜電容量誤差	±20% (120Hz, 20°C)							
Operating Temperature Range 適用溫度範圍	- 40 ~ +85°C				- 25 ~ +85°C			
Rated Voltage Range 額定電壓範圍	10~ 100VDC				160~ 550VDC			
Leakage Current 洩漏電流	$I \leq 3\sqrt{CV}$ (µA) (After 5 minutes application of DC rated voltage, at 20 °C)							
Dissipation Factor 散逸因素(tan δ)	Measurement Frequency:120Hz. Temperature: 20°C							
	Rated Voltage(V)	10	16	25	35	50~100	160~250	330~500
	tan δ(Max)	0.50	0.40	0.35	0.30	0.25	0.20	0.25
When nominal capacitance over 1000µF, tanδ shall be added 0.02 to the listed value with increase of every 1000µF .								
Low Temperature Stability 低溫特性 Impedance Ratio(Max) 阻抗比率(最大值)	Measurement Frequency:120Hz							
	Rated Voltage(V)	10~100		160~250		350~500		
	Z(-25°C)/Z(20°C)	4		4		8		
Z(-40°C)/Z(20°C)	12		15		-			
Load Life 負荷壽命	The following specifications shall be satisfied when the capacitors are restored to 20°C after subjected to DC voltage with the rated ripple current is applied for 5,000 hours at 85°C.							
	Capacitance Change	within ±20% of Initial Value						
	tan δ	200% or less of Initial Specified Value						
	Leakage Current	Initial Specified Value or less						
Shelf Life 放置壽命	The following specifications shall be satisfied when the capacitors are restored to 20°C after exposing them for 1000hours 85°C without voltage applied. Before the measurement. The Capacitance shall be preconditioned by applying voltage according to them 4.1 of JIS C5101-4.							
	Capacitance Change	Within ± 20% of Initial Value						
	tan δ	150% or less of Initial Specified Value						
	Leakage Current	Initial Specified Value or less						
Standards 參照標準	JIS C 5101-4-1 (IEC 60384)							

Frequency Coefficient of Permissible Ripple Current

Rated Voltage (V)	Frequency (Hz)			
	50	120	1K	≥10K
10 ~ 100	0.88	1.00	1.15	1.15
160 ~ 250	0.85	1.00	1.15	1.20
330 ~ 550	0.88	1.00	1.10	1.15

The endurance of capacitors is reduced with internal heating produced by ripple current at the rate of halving the lifetime with every 10°C rise. When long life performance is required in actual use. The rms ripple current has to be reduced.

LXA series

DIMENSIONS(mm)

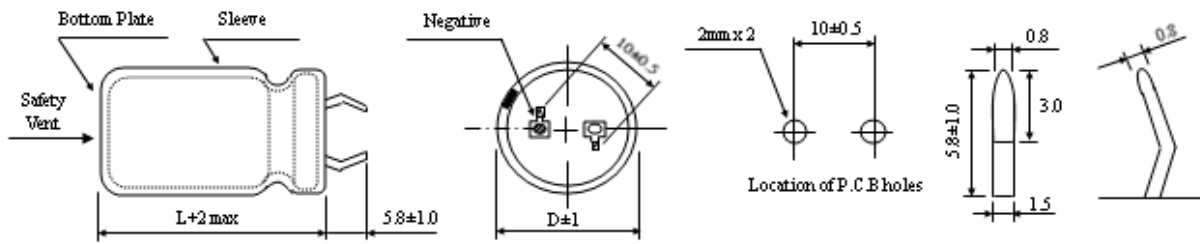

STANDARD RATINGS

DxL(mm), R.C : (A rms) at 85°C 120 Hz

Cap (µF)	V	10		16		25		35		50		63		80	
		Item	D x L	R.C.	D x L	R.C.	D x L	R.C.	D x L	R.C.	D x L	R.C.	D x L	R.C.	D x L
820														22x25	1.37
1000												22x25	1.55	22x25	1.67
1500												22x25	1.71	22x30 25x25	1.84
2200										22x25	2.12	22x30 25x25	2.63	22x35 25x30	2.70
2700										22x30	2.37	22x35 25x30	2.86	22x40 25x30	2.88
3300										22x30 25x25	2.70	22x40 25x30	2.94	22x45 25x40	3.37
3900								22x25	2.49	22x35 25x30	2.77	22x45 25x35	3.21	25x45 30x35	3.47
4700						22x25	2.54	22x30 25x25	2.69	22x40 25x35	3.15	22x50 25x40	3.46	25x50 30x40	3.69
6800				22x25	2.45	22x30 25x25	2.62	22x40 25x30	2.87	22x50 25x40	3.94	25x50 30x40	4.43	30x50 35x40	4.77
8200				22x25	2.96	22x35 25x25	3.02	22x45 25x35	3.18	25x50 30x40	4.51	30x45 35x35	4.94	35x45	5.06
10000		22x25	2.12	22x30	3.14	22x40 25x30	3.47	22x50 25x40	3.62	25x50 30x40	5.08	35x40	5.62	35x50	6.20
12000		22x25	2.45	22x30 25x25	3.57	22x45 25x35	3.68	25x45 30x35	4.1	30x50 35x35	5.26	35x50	6.34		
15000		22x30	2.82	22x35 25x30	4.03	25x45 30x35	4.18	30x40 35x35	5.11	35x45	6.58				
18000		22x35 25x25	3.20	22x40 25x35	4.49	25x45 30x35	4.56	30x45 35x40	5.66	35x50	6.85				
22000		22x40 25x30	3.60	22x50 25x40	4.80	25x50 30x45	5.32	35x45	6.14						
27000		22x45 25x35	4.26	25x45 30x35	5.62	30x50 35x40	6.14	35x50	6.99						
33000		22x50 25x40	5.31	25x50 30x40	5.94	35x45	6.92	35x45	7.09						
39000		25x45 30x35	5.41	30x45 35x35	6.49	35x45	7.75	35x50	7.30						
47000		30x40	6.10	30x50 35x40	7.13	35x50	8.04								
56000		30x45	6.73	35x45	7.31										
68000		35x40	7.43	35x50	10.30										

LXA series

STANDARD RATINGS

Cap (μ F)	V Item	100		160		200		250		350		400		450		500	
		D x L	R.C.	D x L	R.C.	D x L	R.C.	D x L	R.C.	D x L	R.C.	D x L	R.C.	D x L	R.C.	D x L	R.C.
47												22x25	0.43	22x25	0.47	22x35	0.48
100										22x25	0.79	22x30 25x25	1.07	22x35 25x25	1.12	25x40	1.15
120										22x30 25x25	0.95	22x35 25x25	1.17	22x40 25x30	1.23	25x45	1.28
150								22x25	1.12	22x35 25x30	1.18	22x40 25x30	1.28	22x45 25x35	1.47	25x50 30x35	1.53 1.51
220				22x20	1.14	22x25 25x20	1.40	22x30 25x25	1.47	22x45 25x35	1.50	22x50 25x40	1.80	25x45 30x40	1.81	30x45	1.82
330				22x25 25x20	1.48	22x30 25x25	1.92	22x35 25x30	1.97	25x50 30x40	2.03	30x40 35x30	2.35	30x45 35x40	2.85	35x45	2.87
470				22x30 25x25	1.87	22x40 25x30	2.30	22x45 25x35	2.44	30x50 35x40	2.49	35x45	2.88	35x50	2.98	35x60	3.06
560				22x35 25x30	2.07	22x40 25x30	2.62	25x40 30x35	2.87	35x45	3.36	35x50	3.43	35x55	3.21	35x60	3.09
680	22x25	1.57	22x35 25x30	2.42	22x50 25x40	2.90	25x50 30x40	3.28	35x50	3.51	35x50	3.57	35x60	3.43	35x70	3.34	
820	22x25 25x20	1.92	22x40 25x35	2.81	25x45 30x35	3.42	30x45 35x40	3.58	35x50	3.65	35x60	3.91	35x65	3.66	40x70	3.84	
1000	22x30 25x25	1.98	25x40 30x35	3.28	25x50 30x40	3.87	30x50 35x45	4.02	35x55	3.97	35x65	4.28	35x70	3.89	45x80	4.29	
1200	22x30 25x25	2.15	25x40 30x35	3.48	25x50 30x40	4.16	30x50 35x45	4.54	35x60	4.25	35x70	4.50	40x70	4.09	45x90	4.59	
1500	22x35 25x30	2.52	30x45 35x35	4.04	30x50 35x40	5.12	35x50	5.47	35x65	4.65	40x70	4.61	45x70	4.21	45x100	4.90	
2200	22x45 25x40	3.21	35x45	4.77	35x50	6.21	40x60	6.25	45x75	5.87	45x85	5.75	45x100	5.32			
2700	25x45 30x35	3.79	35x50	5.46													
3300	25x50 30x40	4.14															
3900	30x45 35x35	4.64															
4700	30x50 35x40	5.22															
6800	35x50	5.97															

LZ series

- Snap-in type, 105°C 2000 hours standard product.
- High temperature and high ripple current resistance.
- Suitable for computer equipment, inverter air conditioner etc.
- RoHS Compliance
- 基板自立 105°C 2000小時標準品。
- 耐高溫、高紋波。
- 適用於電腦設備、變頻空調等。



SPECIFICATIONS

Items 項目	Characteristics 特性										
Capacitance Tolerance 靜電容量誤差	± 20%(120Hz,20°C)										
Operating Temperature Range 適用溫度範圍	-40 ~ +105°C					-25 ~ +105°C					
Rated Voltage Range 額定電壓範圍	10 ~ 250VDC					350 ~ 500VDC					
Leakage Current 洩漏電流	$I \leq 3\sqrt{CV}$ (µA) (After 5 minutes application of DC rated voltage, at 20 °C)										
Dissipation Factor 散逸因素(tan δ)	Measurement Frequency: 120Hz. Temperature: 20°C										
	Rated Voltage(V)	10	16	25	35	50	63	80	100	160~250	350~500
	tan δ(Max)	0.45	0.40	0.35	0.30	0.25	0.25	0.20	0.20	0.15	0.20
When nominal capacitance over 1000µF, tanδ shall be added 0.01 to the listed value with increase of every 1000µF.											
Low Temperature Stability 低溫特性 Impedance Ratio(Max) 阻抗比率(最大值)	Measurement Frequency: 120Hz.										
	Rated Voltage(V)	10	16	25	35	50	63~100	160~250	350~500		
	Z(-25°C)/Z(20°C)	6	6	4	4	4	4	4	4	8	
	Z(-40°C)/Z(20°C)	16	15	10	10	8	6	15	-		
Load Life 負荷壽命	The following specifications shall be satisfied when the capacitors are restored to 20°C after subjected to DC voltage with the rated ripple current is applied for 2,000 hours at 105°C.										
	Capacitance Change	Within ± 20% of Initial Value									
	tan δ	200% or less of Initial Specified Value									
	Leakage Current	Initial Specified Value or less									
Shelf Life 放置壽命	The following specifications shall be satisfied when the capacitors are restored to 20°C after exposing them for 1,000 hours 105°C without voltage applied. Before the measurement, the capacitor shall be preconditioned by applying voltage according to them 4.1 of JIS C5101-4.										
	Capacitance Change	Within ± 15% of Initial Value									
	tan δ	200% or less of Initial Specified Value									
	Leakage Current	Initial Specified Value or less									
Standards 參照標準	JIS C 5101-4 (IEC 60384)										

Frequency Coefficient of Permissible Ripple Current

Rated Voltage (V)	Frequency (Hz)				
	50	120	1K	10K	100K
10 ~ 100	0.88	1.00	1.15	1.15	1.20
160 ~ 250	0.85	1.00	1.15	1.20	1.20
350 ~ 500	0.88	1.00	1.10	1.15	1.20

The endurance of capacitors is reduced with internal heating produced by ripple current at the rate of halving the lifetime with every 5°C rise. When long life performance is required in actual use, the rms ripple current has to be reduced.

LZ series

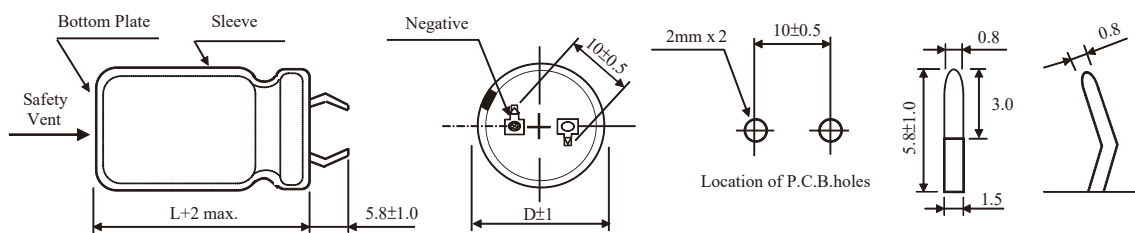

STANDARD RATINGS

D×L(mm) ; R.C.(A rms) at 105°C 120Hz

Cap (μF)	V Item	10		16		25		35		50	
		D x L	R.C.	D x L	R.C.	D x L	R.C.	D x L	R.C.	D x L	R.C.
1500										22x25	1.20
1800										22x30	1.40
2200										22x30 25x25	1.60
2700								22x25	1.21	22x35 25x30	1.73
3300								22x30	1.36	22x40 25x30	1.97
3900						22x25	1.35	22x30	1.57	22x45 25x35	2.23
4700						22x30	1.58	22x35 25x25	1.77	22x50 25x40	2.45
5600						22x30 25x25	1.75	22x40 25x30	1.99	25x45 30x35	2.74
6800				22x25	1.80	22x35 25x30	2.02	22x45 25x35	2.29	30x40 35x30	3.31
8200				22x30 25x25	2.08	22x40 25x35	2.18	22x50 25x40	2.58	30x45 35x35	3.60
10000		22x25	1.88	22x35 25x30	2.15	22x45 25x40	2.48	25x45 30x35	2.90	35x40	4.02
12000		22x30 25x25	2.18	22x40 25x30	2.31	22x50 25x45	2.86	25x50 30x40	3.24	35x50	4.52
15000		22x35 25x30	2.27	22x45 25x35	2.69	25x50 30x40	3.15	30x45 35x35	3.65		
18000		22x40 25x30	2.41	22x50 25x40	3.20	30x45 35x35	3.55	35x40	4.13		
22000		22x45 25x35	2.68	25x45 30x35	3.40	30x50 35x40	4.00	35x50	4.78		
27000		25x40 30x35	3.17	30x40 35x35	3.85	35x45	4.55				
33000		25x45 30x35	3.39	30x50 35x40	4.32	35x50	5.56				
39000		25x50 30x40	3.72	35x40	4.85						
47000		30x45 35x35	4.22	35x50	5.56						
56000		35x40	5.00								
68000		35x50	5.21								

LZ series

STANDARD RATINGS

D×L(mm) ; R.C.(A rms) at 105°C 120Hz

Cap (μF)	V Item	63		80		100		160		200	
		D x L	R.C.	D x L	R.C.	D x L	R.C.	D x L	R.C.	D x L	R.C.
220										22x25	0.82
270								22x25	1.04	22x30	1.07
330								22x30	1.26	22x30 25x25	1.28
390								22x30 25x25	1.29	22x35 25x30	1.31
470								22x35 25x30	1.56	22x40 25x30	1.58
560						22x25	1.02	22x40 25x30	1.69	22x45 25x35	1.72
680						22x30	1.12	22x45 25x35	1.72	25x40 30x30	1.75
820				22x25	1.04	22x30 25x25	1.32	22x50 25x40	1.99	25x50 30x35	2.04
1000				22x30	1.21	22x35 25x30	1.45	25x45 30x35	2.20	30x45 35x35	2.30
1200		25x25	1.21	22x35 25x25	1.29	22x40 25x35	1.68	30x40 35x35	2.45	30x50 35x40	2.65
1500		22x30 25x25	1.45	22x40 25x30	1.57	22x45 25x40	1.98	30x50 35x40	3.06	35x45	3.07
1800		22x35 25x30	1.59	22x45 25x35	1.72	25x45 30x35	2.23	35x45	3.14		
2200		22x40 25x30	1.84	25x40 30x30	2.01	25x50 30x40	2.53	35x50	3.50		
2700		22x45 25x35	2.12	25x45 30x35	2.32	30x45 35x35	2.82				
3300		25x40 30x30	2.30	30x40 35x30	2.62	30x50 35x40	3.32				
3900		25x45 30x35	2.42	30x45 35x35	2.84	35x45	3.62				
4700		25x50 30x40	2.91	30x50	3.29	35x50	3.80				
5600		30x45 35x35	3.18	35x45	3.82						
6800		30x50 35x40	3.54	35x50	3.92						
8200		35x45	3.82	35x50	4.05						
10000		35x50	4.50	35x55	4.85						

LZ series

STANDARD RATINGS

D×L(mm) ; R.C.(A rms) at 105°C 120Hz

Cap (μF)	V Item	250		350		400		450		500	
		D x L	R.C.	D x L	R.C.	D x L	R.C.	D x L	R.C.	D x L	R.C.
68						22x25	0.52	22x35 25x30	0.55	22x40	0.56
82				22x25	0.60	22x30	0.66	22x35 25x30	0.65	25x35	0.68
100				22x30	0.69	22x35 25x25	0.72	22x40 25x30	0.75	25x35	0.78
120		20x20	0.65	22x35 25x30	0.76	22x40 25x30	0.75	22x45 25x40	0.83	25x45	0.85
150		22x25	0.76	22x40 25x30	0.79	22x45 25x35	0.89	22x50 25x40	0.95	25x50 30x40	1.01
180		22x30	0.98	22x45 25x35	0.88	22x50 25x40	0.98	25x45 30x40	1.15	30x45 35x35	1.21
220		22x30 25x25	1.09	22x50 25x40	0.98	25x45 30x35	1.12	30x45 35x40	1.24	30x45 35x40	1.35
270		22x35 25x30	1.19	25x45 30x35	1.10	25x50 30x40	1.29	30x50 35x45	1.46	35x45	1.53
330		22x40 25x35	1.35	30x40 35x35	1.22	30x45 35x35	1.45	35x50	1.65	35x50	1.75
390		22x45 25x35	1.52	30x45 35x40	1.42	30x50 35x40	1.59	35x55	1.78		
470		22x50 25x40	1.63	35x45	1.62	35x45	1.75				
560		25x45 30x35	1.84	35x50	1.89	35x50	2.12				
680		25x50 30x40	2.05	35x50	2.10	35x50	2.20				
820		30x45 35x35	2.29	35x65	2.35	35x65	2.50				
1000		35x40	2.49								
1200		35x45	2.84								

HZ series

- Down size, load life extend to 3000 hours.
- 105°C, high temperature, high ripple current resistance and high reliability.
- RoHS Compliance
- Done size、壽命3000小時。
- 105°C 耐高溫、高紋波、高信賴性。



SPECIFICATIONS

Items 項目	Characteristics 特性										
Capacitance Tolerance 靜電容量誤差	± 20%(120Hz,20°C)										
Operating Temperature Range 適用溫度範圍	-40 ~ +105°C						-25 ~ +105°C				
Rated Voltage Range 額定電壓範圍	16 ~ 250VDC						350 ~ 450VDC				
Leakage Current 洩漏電流	$I \leq 3\sqrt{CV}$ (μA) (After 5 minutes application of DC rated voltage, at 20 °C)										
Dissipation Factor 散逸因素(tan δ)	Measurement Frequency: 120Hz. Temperature: 20°C										
	Rated Voltage(V)	16	25	35	50	63	80	100	160	200~250	350~450
	tan δ (Max)	0.50	0.45	0.40	0.35	0.30	0.25	0.20	0.15	0.15	0.20
	When nominal capacitance over 1000 μF , tan δ shall be added 0.01 to the listed value with increase of every 1000 μF .										
Low Temperature Stability 低溫特性 Impedance Ratio(Max) 阻抗比率(最大值)	Measurement Frequency: 120Hz.										
	Rated Voltage(V)	16	25	35	50	63	80	100	160~250	350~450	
	Z(-25°C)/Z(20°C)	6	6	4	4	4	4	4	4	4	8
	Z(-40°C)/Z(20°C)	16	15	10	10	8	6	6	6	15	-
Load Life 負荷壽命	The following specifications shall be satisfied when the capacitors are restored to 20°C after subjected to DC voltage with the rated ripple current is applied for 3,000 hours at 105°C.										
	Capacitance Change	Within ± 20% of Initial Value									
	tan δ	200% or less of Initial Specified Value									
	Leakage Current	Initial Specified Value or less									
Shelf Life 放置壽命	The following specifications shall be satisfied when the capacitors are restored to 20°C after exposing them for 1,000 hours 105°C without voltage applied. Before the measurement, the capacitor shall be preconditioned by applying voltage according to them 4.1 of JIS C5101-4.										
	Capacitance Change	Within ± 15% of Initial Value									
	tan δ	200% or less of Initial Specified Value									
	Leakage Current	Initial Specified Value or less									
Standards 參照標準	JIS C 5101-4 (IEC 60384)										

Frequency Coefficient of Permissible Ripple Current

Rated Voltage (V)	Frequency (Hz)				
	50	120	1K	10K	100K
16 ~ 100	0.88	1.00	1.05	1.10	1.15
160 ~ 250	0.85	1.00	1.20	1.30	1.50
350 ~ 450	0.88	1.00	1.20	1.25	1.40

The endurance of capacitors is reduced with internal heating produced by ripple current at the rate of halving the lifetime with every 5°C rise. When long life performance is required in actual use , the rms ripple current has to be reduced.

HZ series

DIMENSIONS(mm)

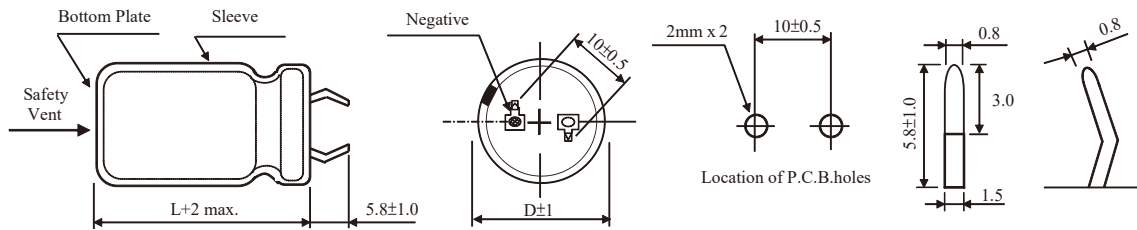

STANDARD RATINGS

D×L(mm) ; R.C.(A rms) at 105°C 120Hz

Cap (μF)	V	16		25		35		50		63		80		100	
		Item	D x L	R.C.	D x L	R.C.	D x L	R.C.	D x L	R.C.	D x L	R.C.	D x L	R.C.	D x L
560														20x25	0.95
680														20x30	1.15
820												20x25	1.04	20x35	1.32
1000										20x25	1.35	20x30 22x25	1.24	20x35 22x30	1.47
1500								20x25	1.02	20x30 22x25	1.47	20x35 22x30	1.59	22x40 25x35	1.98
2200								20x30 22x25	1.60	20x40 22x35	1.82	22x40 25x30	2.03	25x45 30x35	2.55
2700						20x25	1.29	20x35 22x30	1.73	22x35 25x30	2.11	22x45 25x35	2.39	25x50 30x40	2.89
3300						20x30	1.57	20x40 22x35	1.97	22x45 25x35	2.33	25x40 30x35	2.64	30x45 35x35	3.30
3900				20x25	1.65	22x25	1.78	22x40 25x30	2.22	22x50 25x40	2.55	25x50 30x35	2.97	30x50 35x40	3.67
4700				20x25	1.75	20x35 22x30	2.02	22x45 25x35	2.43	25x45 30x35	2.97	30x40 35x35	3.38	35x45	3.80
6800		20x25	1.50	20x35 22x30	2.11	22x40 25x30	2.41	25x45 30x35	3.30	30x40 35x35	3.65	35x45	4.10	35x50	4.05
8200		20x30	1.70	20x40 22x30	2.34	22x45 25x35	2.85	25x50 30x40	3.60	30x50 35x40	4.04	35x50	4.30		
10000		20x35 22x30	1.85	22x35 25x30	2.65	22x50 25x40	3.05	30x45 35x35	4.05	35x45	4.48				
12000		20x40 22x30	2.01	22x40 25x30	2.81	25x45 30x35	3.37	30x50 35x40	4.56	35x50	4.75				
15000		22x35 25x30	2.39	22x45 25x35	3.13	25x50 30x40	3.72	35x50	4.77						
18000		22x40 25x30	2.90	25x40 30x30	3.56	30x45 35x35	4.37								
22000		22x45 25x35	3.10	25x50 30x35	4.04	30x50 35x40	4.92								
27000		22x50 25x40	3.55	30x45 35x35	4.74	35x50	5.30								
33000		25x45 30x35	4.05	30x50 35x40	5.50										
39000		25x50 30x40	4.55	35x45	5.80										
47000		30x45 35x40	5.36	35x50	6.30										
56000		30x50 35x45	5.60												

HZ series

STANDARD RATINGS

D×L(mm) ; R.C.(A rms) at 105°C 120Hz

Cap (μF)	V Item	160		200		250		350		400		450	
		D x L	R.C.	D x L	R.C.	D x L	R.C.	D x L	R.C.	D x L	R.C.	D x L	R.C.
47										22x25	0.45	22x25	0.43
68										22x25	0.50	22x30	0.50
82								22x30	0.55	22x25	0.65	22x30 25x25	0.60
100								22x30 22x25	0.60	22x30 25x25	0.68	22x35 25x30	0.70
120								22x30 25x25	0.70	22x35 25x25	0.75	22x40 25x30	0.78
150						22x25	0.65	22x35 25x30	0.83	22x40 25x30	0.85	22x45 25x35	0.89
220		20x25	1.10	20x25	1.00	20x30 22x25	1.00	22x45 25x35	1.05	22x50 25x40	1.05	25x45 30x35	1.15
330		20x30 22x25	1.21	20x30	1.25	20x40 22x35	1.20	25x45 30x35	1.35	30x40 35x30	1.35	30x50 35x40	1.45
390		20x30 22x25	1.30	22x30 25x25	1.31	22x40 25x30	1.35	25x50 30x40	1.52	30x45 35x35	1.75	35x40	1.65
470		20x35 22x30	1.41	22x35 25x30	1.45	22x45 25x35	1.57	30x45 35x35	1.65	35x40	1.85	35x50	1.85
560		20x40 22x35	1.54	22x40 25x30	1.60	22x50 25x40	1.80	30x50 35x40	1.90	35x45	2.05		
680		20x45 22x40	1.74	22x45 25x35	1.78	25x45 30x35	2.00	35x45	2.00	35x50	2.45		
820		20x45 25x35	2.00	22x50 25x40	1.95	25x50 30x40	2.18	35x55	2.30				
1000		22x50 25x40	2.25	25x45 30x35	2.30	30x45 35x35	2.35						
1200		25x45 30x35	2.49	30x40 35x35	2.65	35x40	2.50						
1500		30x40 35x30	2.84	30x50 35x40	3.08	35x50	3.00						
2200		35x45	3.50	35x50	3.55								
2700		35x50	4.00										

MZ series

- 105°C 5000hours, long life.
- High temperature, high ripple current resistance and high reliability.
- RoHS Compliance
- 105°C 5000小時長壽命。
- 耐高溫、高紋波、高信賴性。



SPECIFICATIONS

Items 項目	Characteristics 特性									
Capacitance Tolerance 靜電容量誤差	± 20%(120Hz,20°C)									
Operating Temperature Range 適用溫度範圍	-40 ~ +105°C					-25 ~ +105°C				
Rated Voltage Range 額定電壓範圍	10 ~ 100VDC					160 ~ 450VDC				
Leakage Current 洩漏電流	$I \leq 3\sqrt{CV}$ (µA) (After 5 minutes application of DC rated voltage, at 20 °C)									
Dissipation Factor 散逸因素(tan δ)	Measurement Frequency: 120Hz. Temperature: 20°C									
	Rated Voltage(V)	10	16	25	35	50	63	80~100	160~400	420~450
	tan δ(Max)	0.60	0.45	0.30	0.25	0.20	0.15	0.15	0.15	0.20
When nominal capacitance over 1000µF, tanδ shall be added 0.01 to the listed value with increase of every 1000µF.										
Low Temperature Stability 低溫特性 Impedance Ratio(Max) 阻抗比率(最大值)	Measurement Frequency: 120Hz.									
	Rated Voltage(V)	10	16	25	35	50	63	80~100	160~400	420~450
	Z(-25°C)/Z(20°C)	4	4	3	3	2	2	2	4	8
Z(-40°C)/Z(20°C)										
15 15 10 8 6 6 5 - -										
Load Life 負荷壽命	The following specifications shall be satisfied when the capacitors are restored to 20°C after subjected to DC voltage with the rated ripple current is applied for 5,000 hours at 105°C.									
	Capacitance Change	Within ± 20% of Initial Value								
	tan δ	200% or less of Initial Specified Value								
	Leakage Current	Initial Specified Value or less								
Shelf Life 放置壽命	The following specifications shall be satisfied when the capacitors are restored to 20°C after exposing them for 1,000 hours 105°C without voltage applied. Before the measurement, the capacitor shall be preconditioned by applying voltage according to them 4.1 of JIS C5101-4.									
	Capacitance Change	Within ± 15% of Initial Value								
	tan δ	200% or less of Initial Specified Value								
	Leakage Current	Initial Specified Value or less								
Standards 參照標準	JIS C 5101-4 (IEC 60384)									

Frequency Coefficient of Permissible Ripple Current

Rated Voltage (V)	Frequency (Hz)				
	50	120	1K	10K	50K
10 ~ 100	0.90	1.00	1.05	1.10	1.15
160 ~ 250	0.80	1.00	1.15	1.45	1.50
315 ~ 450	0.76	1.00	1.14	1.40	1.42

The endurance of capacitors is reduced with internal heating produced by ripple current at the rate of halving the lifetime with every 5°C rise. When long life performance is required in actual use , the rms ripple current has to be reduced.

MZ series

DIMENSIONS(mm)

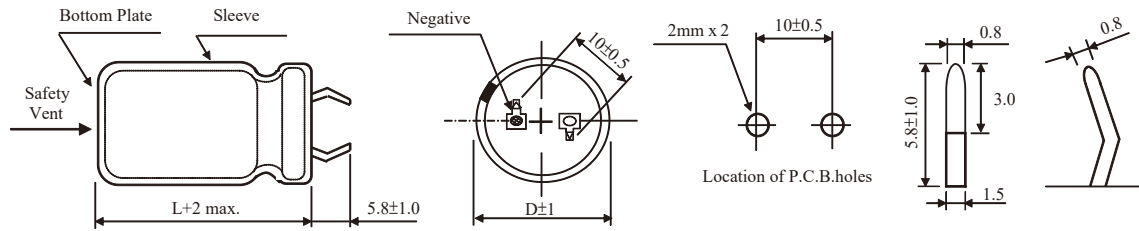

STANDARD RATINGS

D×L(mm) ; R.C.(A rms) at 105°C 120Hz

Cap (μF)	V	10		16		25		35		50	
		D x L	R.C.	D x L	R.C.	D x L	R.C.	D x L	R.C.	D x L	R.C.
1500										22x25	1.02
1800										22x30	1.18
										25x25	1.17
2200								22x25	1.11	22x35	1.32
2700										22x40	1.51
										25x30	1.48
										30x25	1.51
3300								22x30	1.42	25x35	1.71
								25x25	1.41	30x30	1.72
										35x25	1.74
3900						22x25	1.32	22x35	1.58	22x50	1.91
								25x30	1.59	25x40	1.89
4700						22x30	1.51	22x40	1.78	30x35	2.12
						25x25	1.52	30x25	1.78	35x30	2.16
5600				22x25	1.45	22x35	1.71	25x35	1.98	25x50	2.39
								30x30	1.99	30x40	2.39
								35x25	2.03	35x35	2.41
6800		22x25	1.31	22x30	1.67	22x40	1.92	22x50	2.26	30x50	2.79
				25x25	1.66	25x30	1.88				
						30x25	1.90	25x40	2.25	35x40	2.79
8200				22x35	1.88	25x35	2.15	25x50	2.57		
						30x30	2.16	30x35	2.51		
						35x25	2.19	35x30	2.56		
10000		22x30	1.65	22x40	2.12	22x50	2.45	30x40	2.87	35x50	3.56
		25x25	1.63	25x30	2.08						
				30x25	2.12	25x40	2.44	35x35	2.88		
12000		22x35	1.84	25x35	2.38	25x50	2.78	30x50	3.32		
		25x30	1.85	30x30	2.37	30x35	2.71				
		30x25	1.88	35x25	2.41	35x30	2.76	35x40	3.31		
15000		22x40	2.11	22x50	2.74	30x40	3.14				
		25x35	2.15	25x40	2.72	35x35	3.16				
18000		22x50	2.45	25x50	3.12	30x50	3.63	35x50	4.28		
		25x40	2.42	30x35	3.03						
		30x30	2.38	35x30	3.09	35x40	3.62				
		35x25	2.41								
22000		30x35	2.72	30x40	3.47						
		35x30	2.78	35x35	3.49						
27000		25x50	3.12	30x50	4.07	35x50	4.72				
		30x40	3.14	35x40	4.05						
33000		35x35	3.48								
39000		30x50	3.98	35x50	5.15						
		35x40	3.95								
47000		35x50	4.62								

MZ

MZ series

STANDARD RATINGS

D×L(mm) ; R.C.(A rms) at 105°C 120Hz

Cap (μF)	V Item	63		80		100		160		180		
		D x L	R.C.	D x L	R.C.	D x L	R.C.	D x L	R.C.	D x L	R.C.	
330										22x25	1.22	
390						22x25	0.78	22x25	1.32			
470										22x30	1.53	
										25x25	1.52	
560						22x30	0.99	22x30	1.66	22x35	1.70	
						25x25	0.98	25x25	1.67	30x25	1.78	
680				22x25	0.97	22x35	1.12	22x35	1.87	22x40	1.91	
								25x30	1.89			
								30x25	1.95	25x30	1.89	
820				22x30	1.12	22x40	1.26	22x40	2.09	22x45	1.99	
						25x30	1.24			25x35	2.16	
						30x25	1.25			30x30	2.17	
1000		22x25	1.00	22x35	1.26	25x35	1.41	22x45	2.41	22x50	2.25	
					30x30	1.42	25x40	2.38	25x45	2.47		
					25x25	1.24	30x30	2.39	30x30	2.39	30x35	2.46
							35x25	1.44	35x30	2.53		
1200		22x30	1.16	22x40	1.42	22x50	1.60	25x45	2.71	25x50	2.76	
		25x25	1.15	25x30	1.40	25x40	1.59	30x40	2.76	30x40	2.77	
				30x25	1.41	30x35	1.61	35x30	2.85	35x35	2.85	
1500		22x35	1.32	25x35	1.62	25x50	1.86	25x50	3.09	30x45	3.17	
							30x40	1.87	30x45	3.16	30x50	3.20
							35x30	1.85	35x40	3.21	35x35	3.22
1800		22x40	1.49	22x50	1.84	35x35	2.06	30x50	3.53	35x45	3.73	
		25x30	1.46	25x40	1.83							
		30x30	1.48	30x30	1.79			35x45	3.64			
		30x25	1.48	35x25	1.82							
2200		25x35	1.67	25x50	2.10	30x50	2.40	35x50	4.14	35x50	4.23	
		30x30	1.68	30x35	2.06	35x40	2.39					
		35x25	1.70	35x25	2.09							
2700		22x50	1.92	30x40	2.35	35x50	2.81					
		25x40	1.91	35x35	2.36							
		30x35	1.93									
3300		25x50	2.20	30x50	2.75							
		35x30	2.18	35x40	2.73							
3900		30x40	2.41									
		35x35	2.43									
4700		30x50	2.79	35x50	3.46							
		35x40	2.78									
6800		35x50	3.55									

MZ series

STANDARD RATINGS

D×L(mm) ; R.C.(A rms) at 105°C 120Hz

Cap (μF)	V Item	200		220		250		315	
		D x L	R.C.	D x L	R.C.	D x L	R.C.	D x L	R.C.
150								22x25	0.80
180								22x30	0.93
								25x25	0.94
220		22x25	1.00			22x25	1.01	22x35	1.04
270		22x25	1.11	22x25	1.11	22x30	1.20	25x25	1.16
	22x40							1.18	
330				22x30	1.18	25x30	1.32	25x30	1.19
								22x45	1.33
								25x35	1.37
								30x30	1.40
390		22x30	1.38	22x35	1.39	22x40	1.44	22x50	1.49
		25x25	1.39	25x25	1.39	25x30	1.43	25x40	1.52
						30x25	1.50		
470		22x35	1.55	22x35	1.55	22x45	1.62	25x45	1.70
				25x30	1.56	25x35	1.70	30x35	1.71
				30x25	1.62	30x30	1.74	35x30	1.81
560		22x40	1.73	22x45	1.73	22x50	1.84	25x50	1.88
		25x30	1.72	25x35	1.81	25x40	1.78	30x40	1.92
						30x35	1.83	30x45	1.97
		30x25	1.77	30x30	1.85	35x25	1.90	35x35	1.99
680		22x45	1.82	22x50	1.98	25x45	2.04	30x50	2.21
		25x35	1.86	25x40	1.96	30x40	2.06		
		30x30	1.97	30x35	2.02			35x30	2.14
		35x25	2.09	35x25	2.09				
820		25x50	2.17	25x45	2.24	25x50	2.28	35x45	2.57
		25x40	2.09	30x40	2.29	30x45	2.38		
		30x35	2.21	35x30	2.35	35x35	2.37		
1000		25x50	2.39	25x55	2.52	30x50	2.68	35x50	2.89
		30x40	2.53	30x45	2.58				
		35x30	2.60	35x35	2.63	35x40	2.71		
1200		30x45	2.85	30x50	2.89	35x45	3.05		
		35x40	2.88	35x40	2.97				
1500		35x45	3.34	35x45	3.41	35x50	3.49		
1800		35x50	3.82	35x50	3.82				

MZ series

STANDARD RATINGS

D×L(mm) ; R.C.(A rms) at 105°C 120Hz

Cap (μF)	V Item	350		400		420		450													
		D x L	R.C.	D x L	R.C.	D x L	R.C.	D x L	R.C.												
82								22x25	0.60												
100				22x25	0.66	22x25	0.66	22x30	0.69												
								25x25	0.70												
120	22x25	0.72	22x30	0.75		22x30	0.76	22x35	0.76												
						25x25	0.77														
150	22x30	0.84	22x35	0.85		22x35	0.86	22x45	0.90												
								25x25	0.86	25x35	0.92										
										30x25	0.93										
180	25x25	0.94	22x40	0.96		22x45	0.98	22x50	1.01												
								25x30	0.97	25x35	1.01	25x40	1.02								
												30x25	1.03	30x30	1.03						
														35x25	1.09						
220	22x40	1.06	22x45	1.09		22x50	1.11	25x45	1.16												
								25x30	1.07	25x35	1.12	25x40	1.13								
												30x30	1.14	30x35	1.17						
														35x25	1.21						
270	22x45	1.21	22x50	1.24		25x45	1.29	25x50	1.31												
								25x35	1.24	25x45	1.29	30x35	1.30	30x40	1.33						
														30x30	1.27	30x35	1.27	35x30	1.37	35x35	1.38
330	22x50	1.37	25x50	1.44		25x50	1.45	30x45	1.51												
										25x40	1.39	30x35	1.43	30x40	1.48						
																30x35	1.42	35x30	1.51	35x35	1.54
390	25x45	1.55	30x40	1.61		30x45	1.65	30x50	1.67												
										30x40	1.59	35x35	1.66	35x40	1.73	35x45	1.76				
																		35x30	1.65		
470	25x50	1.73	30x50	1.85		30x50	1.85	35x50	1.98												
										30x45	1.81	35x40	1.89	35x45	1.93						
																35x35	1.82				
560	30x50	2.01	35x45	2.13		35x50	2.17														
								35x40	2.06												
680		35x45	2.34	35x50	2.38																
820		35x50	2.62																		

TZ series

- Snap-in type, 105°C10000 hours long life product.
- Long life. and high ripple current resistance.
- Suitable for computer equipment, inverter air conditioner etc.
- RoHS Compliance
- 基板自立 105°C10000小時長壽命品
- 耐高溫、高紋波。
- 適用於電腦設備、變頻空調等。



SPECIFICATIONS

Items 項目	Characteristics 特性		
Capacitance Tolerance 靜電容量誤差	± 20%(M)		
Operating Temperature Range 適用溫度範圍	-25 ~ +105°C		
Rated Voltage Range 額定電壓範圍	200 ~ 450VDC		
Leakage Current 洩漏電流	$I \leq 3\sqrt{CV}$ (µA) or 5mA, which is greater. (After 5 minutes application of DC rated voltage, at 20 °C)		
Dissipation Factor 散逸因素(tan δ)	Measurement Frequency: 120Hz. Temperature: 20°C		
	Rated Voltage(V)	200~400V	450V
	tan δ(Max)	0.15	0.20
Temperature Stability 溫度特性	Measurement Frequency: 120Hz.		
	Rated Voltage(V)	200~400V	450V
	Z(-25°C)/Z(20°C)	4	8
Load Life 負荷壽命	The following specifications shall be satisfied when the capacitors are restored to 20°C after subjected to DC voltage with the rated ripple current is applied for 10,000 hours at 105°C.		
	Capacitance Change	Within ± 20% of the Initial Value	
	tan δ	250% or less of Initial Specified Value	
	Leakage Current	Initial Specified Value or less	
Shelf Life 放置壽命	The following specifications shall be satisfied when the capacitors are restored to 20°C after exposing them for 1,000 hours 105°C without voltage applied. Before the measurement, the capacitor shall be preconditioned by applying voltage according to them 4.1 of JIS C5101-4.		
	Capacitance Change	Within ± 15% of the Initial Value	
	tan δ	150% or less of Initial Specified Value	
	Leakage Current	Initial Specified Value or less	
Standards 參照標準	JIS C 5101-4-1 (IEC 60384)		

Frequency Coefficient of Permissible Ripple Current

Rated Voltage (V)	Frequency (Hz)					
	50	120	300	1K	10K	50K
200~250	0.81	1.00	1.17	1.32	1.45	1.50
400~450	0.77	1.00	1.16	1.30	1.41	1.43

The endurance of capacitors is reduced with internal heating produced by ripple current at the rate of halving the lifetime with every 5°C rise. When long life performance is required in actual use, the rms ripple current has to be reduced.

TZ series

DIMENSIONS(mm)

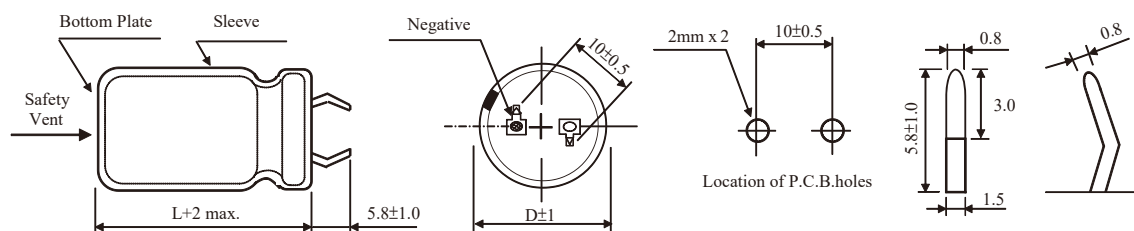

STANDARD RATINGS

D×L(mm) ; R.C.(A rms) at 105°C 120Hz

Cap (μF)	V (Code) Item	200		250		400		450	
		D x L	R.C.	D x L	R.C.	D x L	R.C.	D x L	R.C.
220						30x35	1.01	30x40	1.05
								35x30	1.03
270						30x40	1.20	30x45	1.20
						35x30	1.15	35x35	1.15
330						30x45	1.30	30x50	1.32
						35x35	1.28	35x40	1.35
						40x30	1.28		
390				30x30	1.31	30x50	1.45	35x45	1.50
						35x40	1.45		
470				30x35	1.42	35x45	1.61	35x50	1.65
						40x35	1.60		
560	30x30	1.51		35x30	1.60	35x50	1.80	40x60	2.00
						40x40	1.80		
680	30x35	1.65		30x45	1.78	40x50	2.05		
				35x35	1.78				
820	30x40	2.02		30x50	2.05	40x60	2.35		
	35x30			35x40	2.02				
				40x30	1.98				
1000	30x45	2.21		35x45	2.20				
	35x35			40x35	2.30				
	40x30			2.15					
1200	35x40	2.38		35x50	2.58				
	40x35	2.45		40x40	2.55				
1500	35x50	2.85		40x50	2.98				
	40x40	2.80							
1800	40x50	3.25		40x60	3.40				

AZ series

- Protective countermeasure against DC over-voltage, 105°C 2000hours load life.
- RoHS Compliance
- DC過電壓安全對策，壽命保證 2000小時。



SPECIFICATIONS

Items 項目	Characteristics 特性		
Capacitance Tolerance 靜電容量誤差	± 20%(120Hz,20°C)		
Operating Temperature Range 適用溫度範圍	-25 ~ +105°C		
Rated Voltage Range 額定電壓範圍	200VDC、400VDC、420VDC		
Leakage Current 洩漏電流	$I \leq 3\sqrt{CV}$ (µA) (After 5 minutes application of DC rated voltage, at 20 °C)		
Dissipation Factor 散逸因素(tan δ)	Measurement Frequency: 120Hz. Temperature: 20°C		
	Rated Voltage(V)	200	400
	tan δ(Max)	0.15	0.15
Low Temperature Stability 低溫特性 Impedance Ratio(Max) 阻抗比率(最大值)	Measurement Frequency: 120Hz.		
	Rated Voltage(V)	200	400、420
	Z(-25°C)/Z(20°C)	3	8
Load Life 負荷壽命	The following specifications shall be satisfied when the capacitors are restored to 20°C after subjected to DC voltage with the rated ripple current is applied for 2,000 hours at 105°C.		
	Capacitance Change	Within ± 20% of the Initial Value	
	tan δ	200% or less of Initial Specified Value	
	Leakage Current	Initial Specified Value or less	
Shelf Life 放置壽命	The following specifications shall be satisfied when the capacitors are restored to 20°C after exposing them for 1,000 hours 105°C without voltage applied. Before the measurement, the capacitor shall be preconditioned by applying voltage according to them 4.1 of JIS C5101-4.		
	Capacitance Change	Within ± 15% of the Initial Value	
	tan δ	≤150% of the Initial Specified Value	
	Leakage Current	Initial Specified Value or less	
Standards 參照標準	JIS C 5101-4 (IEC 60384)		

◆ DC over voltage test conditions

The vent will be operated and the capacitor shall become an open circuit without burning materials when the following excess DC voltage is applied.

According to the following experimental conditions, applying below rated voltage and rated current to be evaluated.

TEST DC VOLTAGE

Rated Voltage	Current Limit	Test DC Voltage
200 Vdc	1A	375 V
400 Vdc	1A	600 V
420 Vdc	1A	630 V
450 Vdc	1A	675 V

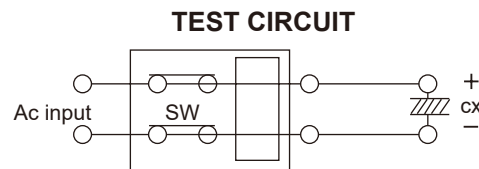

Determination: More than 80 percent of products explosion-proof vent operating normally, there is no any short-circuited, spark allowed.

Frequency Coefficient of Permissible Ripple Current

Rated Voltage (V)	Frequency (Hz)					
	50	60	120	500	1K	≥10K
200	0.80	0.80	1.00	1.10	1.14	1.18
400、420	0.80	0.80	1.00	1.05	1.10	1.15

The endurance of capacitors is reduced with internal heating produced by ripple current at the rate of halving the lifetime with every 5°C rise. When long life performance is required in actual use, the rms ripple current has to be reduced.

AZ series

DIMENSIONS(mm)

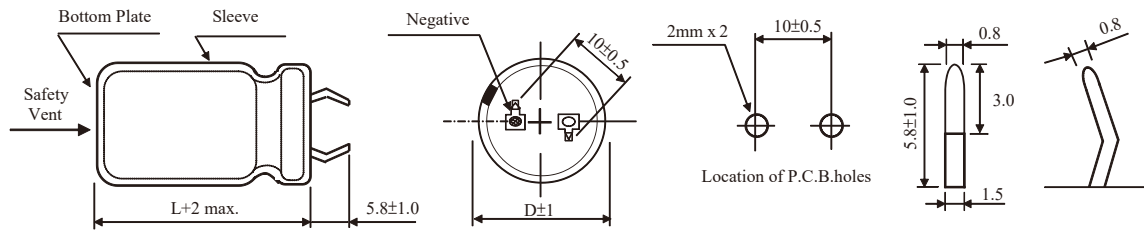

STANDARD RATINGS

D×L(mm) ; R.C.(A rms) at 105°C 120Hz

Cap (μF)	V	200		400		420	
		D x L	R.C.	D x L	R.C.	D x L	R.C.
33				22x20	0.22	22x25	0.25
39				22x20	0.30		
47	22x20	0.35		22x25	0.35	22x25	0.35
				25x20	0.35		
				30x20	0.40		
56				22x25	0.38	22x25	0.38
				25x20	0.38		
68				22x25	0.40	22x30	0.45
				25x25	0.45		
				30x20	0.50		
82				22x30	0.50	22x35	0.64
				25x25	0.50		
				30x20	0.50		
100	22x20	0.50		22x35	0.55	22x40	0.69
				25x30	0.53		
				30x25	0.53		
				35x20	0.55		
120				22x40	0.60	22x45	0.75
				25x30	0.60		
				30x25	0.60		
				30x30	0.75		
150				22x45	0.70	25x40	0.82
				25x35	0.70		
				30x30	0.70		
				35x25	0.70		
180	22x25	0.70		22x50	0.80	25x45	0.90
				25x40	0.80		
	30x20	0.70		30x30	0.80	30x35	0.90
				35x25	0.80		
220	22x25	0.74		25x45	0.90	30x40	1.00
				30x35	0.90		
				35x30	0.90		
				35x35	1.00		
270				30x40	0.98	30x45	1.10
				25x25	0.85		
				30x20	1.10		
330				35x35	0.96	35x40	1.10
				22x30	1.05		
				25x30	1.05		
390				30x50	1.21	35x45	1.20
				30x25	1.05		
				22x35	1.20		
470				35x40	1.21		
				25x30	1.20		
				30x25	1.20		
560				22x40	1.30		
				25x35	1.30		
				30x25	1.35		
680				22x45	1.50		
				25x40	1.50		
				30x35	1.55		
				35x25	1.55		
820				25x50	1.70		
				30x40	1.70		
				35x30	1.70		
1000				30x45	1.99		
				35x35	1.99		
				30x50	2.10		
1200				35x40	2.10		
				35x50	2.30		

AZ

AU series

- Snap-in type 105°C 2000 hours specially designed for audio equipment
- Select structural materials with high sound quality
- Create high definition audio equipment with high sound quality
- Suitable for high quality audio equipment
- RoHS Compliance
- 基板自立 105°C 2000小時音響專用鋁電解電容器
- 精選高音質結構材料
- 打造高品質HD音響設備的音響效果
- 適用於高音質音響設備
- 環境對策品



SPECIFICATIONS

Items 項目	Characteristics 特性						
Capacitance Tolerance 靜電容量誤差	± 20% (M)						
Operating Temperature Range 適用溫度範圍	- 40 ~ +105°C			- 25 ~ +105°C			
Rated Voltage Range 額定電壓範圍	16 ~ 250VDC			400 ~ 450VDC			
Leakage Current 洩漏電流	I ≤ 3√CV (µA) or 5mA, which is greater. (After 5 minutes application of DC rated voltage, at 20 °C)						
Dissipation Factor 散逸因素(tan δ)	Measurement Frequency: 120Hz. Temperature: 20°C						
	Rated Voltage(V)	16V	25~63V	80~100V	200~400V	450V	
	tan δ(Max)	0.35	0.30	0.25	0.15	0.20	
When nominal capacitance over 22000µF, tanδ shall be added 0.02 to the listed value with increase of every 1000µF.							
Low Temperature Stability 低溫特性 Impedance Ratio(Max) 阻抗比率(最大值)	Measurement Frequency: 120Hz.						
	Rated Voltage(V)	16~250			400~450		
	Z(-25°C)/Z(20°C)	4			8		
	Z(-40°C)/Z(20°C)	12			-		
Load Life 負荷壽命	2000hours, with application of rated Voltage voltage at 105°C						
	Capacitance Change	Within ± 20% of Initial Value					
	tan δ	200% or less of Initial Specified Value					
	Leakage Current	Initial Specified Value or less					
Shelf Life 放置壽命	The following specifications shall be satisfied when the capacitors are restored to 20°C after exposing them for 1000hours 105°C without voltage applied. Before the measurement. The Capacitance shall be preconditioned by applying voltage according to them 4.1 of JIS C5101-4.						
	Capacitance Change	Within ± 20% of Initial Value					
	tan δ	200% or less of Initial Specified Value					
	Leakage Current	Initial Specified Value or less					
Standards 參照標準	JIS C 5101-4-1 (IEC 60384)						

Frequency Coefficient of Permissible Ripple Current

Rated Voltage (V)	Frequency (Hz)					
	50	120	300	1K	10K	50K
16~250	0.81	1.00	1.17	1.32	1.45	1.50
400~450	0.77	1.00	1.16	1.30	1.41	1.43

The endurance of capacitors is reduced with internal heating produced by ripple current at the rate of halving the lifetime with every 5°C rise. When long life performance is required in actual use, the rms ripple current has to be reduced.

AU series

DIMENSIONS(mm)

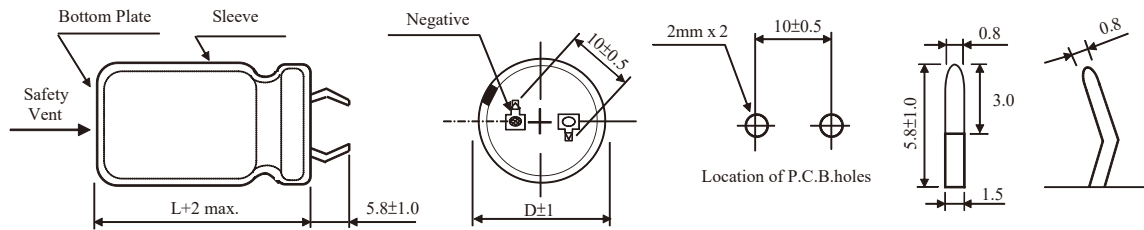

STANDARD RATINGS

D×L(mm) ; R.C.(A rms) at 105°C 120Hz

Cap (µF)	V	16		25		35		50	
		D x L	R.C.	D x L	R.C.	D x L	R.C.	D x L	R.C.
1500								22x20	1.34
1800								20x25	1.47
								25x20	1.43
2200						22x20	1.26	20x30	1.6
								22x25	1.6
2700						20x25	1.39	20x35	1.73
								22x30	1.73
						25x20	1.34	25x25	1.69
								30x20	1.78
3300				22x20	1.30	20x30	1.52	20x40	1.95
						22x25	1.52	22x35	1.91
3900				20x25	1.39			20x45	2.13
						30x20	1.6	22x40	2.04
				25x20	1.34			25x30	2.17
								30x25	2.04
								35x20	2.13
4700		22x20	1.17	20x30	1.47	20x35	1.91	20x50	2.39
				22x25	1.47	22x30	1.91	22x45	2.26
						25x25	1.86	25x35	2.34
5600		20x25	1.26	30x20	1.60	20x40	2.08	22x50	2.52
						22x35	2.04	25x40	2.52
						25x30	1.95	30x30	2.60
						35x20	1.95	35x25	2.47
6800		25x20	1.47	20x35	1.91	20x50	2.17	25x45	2.86
				22x30	1.91	22x40	2.26		
				25x25	1.86	30x25	2.26	30x35	2.82
8200		20x30	1.65	20x40	2.08	22x45	2.52	30x40	3.08
				22x35	2.04	25x40	2.34		
		22x25	1.65	25x30	2.00	30x30	2.39	35x30	3.17
				35x20	1.95				
10000		20x35	1.78	20x50	2.21	25x45	2.65	30x45	3.47
		22x30	1.78	22x40	2.3	30x35	2.60		
		25x25	1.73	25x35	2.17			35x35	3.47
		30x20	1.82	30x25	2.3	35x25	2.78		
12000		20x40	1.95	22x45	2.52	25x50	3.00	35x40	3.78
		22x35	1.91	25x40	2.39	30x40	2.86		
		25x30	1.86	30x30	2.43	35x30	2.95		
		35x20	1.82	35x25	2.3				
15000		20x45	2.26	25x45	2.73	30x45	3.30	35x50	4.08
		22x40	2.17						
		25x35	2.08	30x35	2.69	35x35	3.30		
		30x25	2.17						
18000		22x45	2.43	25x50	3.08	30x50	3.73		
		25x40	2.26	30x40	2.95	35x40	3.60		
		30x30	2.30	35x30	3.04				
22000		25x45	2.56	30x45	3.34	35x45	4.08		
		30x35	2.52	35x35	3.34				
		35x25	2.52						
27000		25x50	2.95	35x40	3.73				
		30x40	2.82						
		35x30	2.91						
33000		30x45	3.21	35x45	4.21				
		35x35	3.17						

AU

AU series

STANDARD RATINGS

D×L(mm) ; R.C.(A rms) at 105°C 120Hz

Cap (μF)	V Item	63		80		100	
		D x L	R.C.	D x L	R.C.	D x L	R.C.
680						20x30	1.47
						22x25	1.52
820	22x20	1.13		20x25	1.47	20x35	1.60
				25x20	1.43	22x30	1.60
						25x25	1.56
1000	20x25	1.26		20x30	1.56	20x40	1.78
				22x25	1.60		
1200	25x20	1.43		20x35	1.69	20x45	2.00
				22x30	1.69	22x40	1.91
				25x25	1.65	25x30	2.04
						30x20	1.73
				30x25	1.91	35x20	2.00
1500	20x30	1.65		20x40	1.91	20x50	2.3
	22x25	1.65		22x35	1.86	22x45	2.21
				25x30	1.82	25x35	2.26
1800	20x35	1.78		20x45	2.13	22x50	2.47
	22x30	1.73		22x40	2.04	25x40	2.47
	25x25	1.73		30x25	2.08	30x30	2.52
	30x20	1.78		35x20	2.17	35x25	2.39
2200	20x40	1.95		22x45	2.34	25x45	2.78
	22x35	1.91		25x35	2.39	30x35	2.78
	25x30	1.86		30x30	2.21	35x30	2.6
	35x20	1.82					
2700	20x50	2.08		30x35	2.43	30x40	3.08
	22x40	2.13					
	25x35	2.04		35x25	2.60	35x35	2.82
	30x25	2.17					
3300	22x45	2.43		25x50	2.82	30x50	3.26
	25x40	2.26		30x40	2.73		
	30x30	2.34		35x30	2.78		
3900	25x45	2.47		30x45	3.00	35x40	3.73
	30x35	2.47		35x35	2.95		
	35x25	2.60					
4700	25x50	2.78		30x45	3.34	35x50	3.91
	30x40	2.69		35x40	3.26		
	35x30	2.78					
5600	30x45	3.00		35x45	3.56		
	35x35	2.95					
6800	30x50	3.39		35x50	4.04		
	35x40	3.26					
8200	35x45	3.65					
10000	35x50	4.17					

D×L(mm) ; R.C.(A rms) at 105°C 120Hz

AU series

DIMENSIONS(mm)

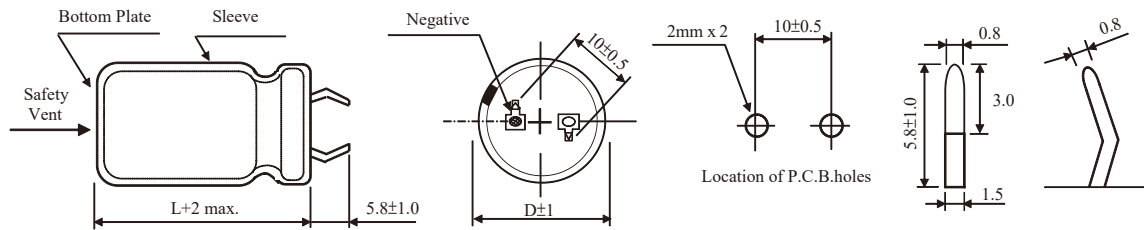

STANDARD RATINGS

D×L(mm) ; R.C.(A rms) at 105°C 120Hz

Cap (μF)	V	200		250		400		450		
		Item	D x L	R.C.	D x L	R.C.	D x L	R.C.	D x L	R.C.
56								20x25	0.44	
68						20x25	0.49	20x30	0.50	
82						20x30	0.64	20x35	0.64	
						22x25	0.64	22x30	0.64	
100						20x35	0.68	20x40	0.69	
					22x30			0.69		
					25x25			0.69		
120						20x35	0.73	20x45	0.72	
						22x30	0.73	22x35	0.72	
						25x25	0.73	25x30	0.72	
150						20x45	0.85	22x45	0.79	
						22x35	0.85	25x35	0.79	
						25x30	0.85	30x25	0.79	
180				20x25	0.90	20x50	0.95	22x50	0.87	
						22x40	0.95	25x40	0.87	
						25x35	0.95	30x30	0.87	
220		20x25	0.90	20x30	1.00	22x50	1.1	25x45	1.05	
					25x40	1.1				
					30x30	1.1				
					35x25	1.1				
270		20x30	0.99	20x35	1.10	25x45	1.22	30x40	1.23	
		22x25	0.99	22x30	1.10	30x35	1.22	35x30	1.23	
330		20x35	1.2	20x40	1.20	25x50	1.44	30x45	1.38	
					22x35	1.20	30x40			1.44
					25x25	1.20	35x30			1.44
390		20x40	1.31	20x45	1.30	30x45	1.55	35x40	1.61	
		22x30	1.31	22x40	1.30	35x35	1.55			
		25x25	1.31	25x30	1.30					
470		20x45	1.48	20x50	1.40	30x50	1.68	35x45	1.78	
		22x35	1.48	22x45	1.40					
		25x30	1.48	25x35	1.40					
560				30x25	1.40	35x40	1.68			
		20x50	1.60	22x50	1.50					
		22x40	1.6	25x40	1.50					
		25x35	1.60	30x30	1.50					
680				35x25	1.50	35x45	1.90	35x50	1.99	
		22x45	1.75	25x50	1.70					
		25x40	1.75							
		30x30	1.75							
820				35x25	1.75	35x50	2.12			
		25x45	2.04	30x40	2.00					
		30x35	2.04	35x30	2.00					
1000										
		25x50	2.3	30x45	2.20					
		30x40	2.3							
1200				35x35	2.20					
		30x45	2.65							
1500				35x40	2.30					
		35x35	2.65							
1800										
		30x50	2.80	35x50	2.50					
2200										
		35x40	2.80							
		35x45	3.08							
		35x50	3.48							

LM series

- 85°C 2000hours, LUG terminal type.
- High ripple current resistance.
- Suitable for power supply, control circuit of inverter.
- RoHS Compliance
- 85°C 2000小時插片式電容。
- 耐高紋波電流。
- 適用於電源供應器、變頻器控制電路。



SPECIFICATIONS

Items 項目	Characteristics 特性					
Capacitance Tolerance 靜電容量誤差	± 20%(120Hz,20°C)					
Operating Temperature Range 適用溫度範圍	-40 ~ +85°C		-25 ~ +85°C			
Rated Voltage Range 額定電壓範圍	16 ~ 250VDC		315 ~ 450VDC			
Leakage Current 洩漏電流	I ≤ 0.02CV (μA) or 5mA, whichever is smaller. (After 5 minutes application of DC rated voltage, at 20 °C)					
Dissipation Factor 散逸因素(tan δ)	Measurement Frequency: 120Hz. Temperature: 20°C					
	Rated Voltage(V)	16	25	35~50	63~315	350~450
	tan δ(Max)	0.35	0.30	0.25	0.20	0.25
When nominal capacitance over 1000μF, tanδ shall be added 0.01 to the listed value with increase of every 1000μF .						
Low Temperature Stability 低溫特性 Impedance Ratio(Max) 阻抗比率(最大值)	Measurement Frequency: 120Hz.					
	Rated Voltage(V)	16~100		160~250		315~450
	Z(-25°C)/Z(20°C)	6		4		8
	Z(-40°C)/Z(20°C)	12		-		-
Load Life 負荷壽命	The following specifications shall be satisfied when the capacitors are restored to 20°C after subjected to DC voltage with the rated ripple current is applied for 2,000 hours at 85°C.					
	Capacitance Change	Within ± 20% of Initial Value				
	tan δ	200% or less of Initial Specified Value				
	Leakage Current	Initial Specified Value or less				
Shelf Life 放置壽命	The following specifications shall be satisfied when the capacitors are restored to 20°C after exposing them for 1,000 hours 85°C without voltage applied. Before the measurement, the capacitor shall be preconditioned by applying voltage according to them 4.1 of JIS C5101-4.					
	Capacitance Change	Within ± 20% of Initial Value				
	tan δ	200% or less of Initial Specified Value				
	Leakage Current	Initial Specified Value or less				
Standards 參照標準	JIS C 5101-4 (IEC 60384)					

Frequency Coefficient of Permissible Ripple Current

Rated Voltage (V)	Frequency (Hz)			
	50	120	1K	≥10K
16 ~ 100	0.90	1.00	1.20	1.25
160 ~ 315	0.95	1.00	1.20	1.25
350 ~ 450	0.98	1.00	1.15	1.20

The endurance of capacitors is reduced with internal heating produced by ripple current at the rate of halving the lifetime with every 10°C rise. When long life performance is required in actual use , the rms ripple current has to be reduced.

LM series

D×L(mm) ; R.C.(A rms) at 105°C 120Hz

DIMENSIONS(mm)

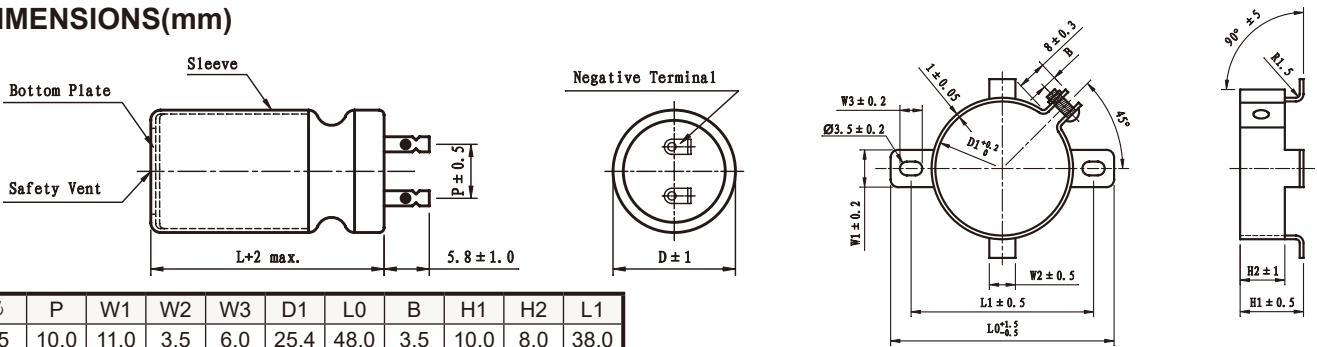

φ	P	W1	W2	W3	D1	L0	B	H1	H2	L1
25	10.0	11.0	3.5	6.0	25.4	48.0	3.5	10.0	8.0	38.0
30	10.0	11.0	3.5	6.0	30.0	52.0	4.0	11.0	9.0	42.0
35	14.0	11.0	3.5	6.0	34.9	58.0	3.5	15.0	10.0	48.0
40	18.0	14.0	3.5	7.0	40.0	65.0	3.0	18.5	12.5	53.5
51	20.0	14.0	4.0	7.0	51.0	72.0	5.5	18.5	15.0	61.0

STANDARD RATINGS

D×L(mm) ; R.C.(A rms) at 85°C 120Hz

Cap (μF)	V	16		25		35		40		50	
		Item	D x L	R.C.	D x L	R.C.	D x L	R.C.	D x L	R.C.	D x L
3300								25x30	2.45	25x30	2.47
4700						25x30	2.88	25x40	3.21	25x40	3.22
6800				25x30	3.12	25x40	3.73	25x50	4.07	25x50	4.09
10000		25x30	3.43	25x40	4.03	25x50	4.71	25x60	5.07	30x50	5.10
15000		25x40	4.42	25x50	5.08	30x50	5.81	30x60	6.24	35x60	6.67
22000		25x50	5.44	30x50	6.15	35x60	7.45	35x60	7.48	35x80	8.34
33000		30x50	6.57	35x60	7.85	35x80	9.17	35x80	9.25	40x100	10.60
47000		35x60	8.19	35x80	9.48	40x100	11.30	51x105	12.50	51x105	12.80
68000		35x80	9.85	40x100	11.60	51x105	13.20				
100000		40x100	12.10	51x105	13.50						
150000		51x105	13.90								

Cap (μF)	V	63		80		100		160		200	
		Item	D x L	R.C.	D x L	R.C.	D x L	R.C.	D x L	R.C.	D x L
330								25x30	0.92	25x30	0.95
470								25x40	1.22	25x40	1.25
680								25x50	1.60	25x50	1.63
1000						25x30	1.61	25x60	2.08	30x50	2.12
1500				25x30	1.91	25x40	2.13	30x60	2.68	35x50	2.87
2200		25x30	2.06	25x40	2.52	25x50	2.75	35x60	3.40	35x60	3.81
3300		25x40	2.73	25x50	3.29	30x50	3.53	35x100	5.02	35x80	5.27
4700		25x50	3.50	25x60	4.14	35x60	4.76	40x100	6.15	40x100	6.81
6800		25x60	4.37	30x60	5.15	35x80	6.17	51x105	7.86	51x105	8.12
10000		30x60	5.46	35x80	7.08	40x100	8.16				
15000		35x80	7.48	40x80	8.42	51x105	10.20				
22000		35x100	9.16	51x105	11.20						
33000		51x105	11.70								

Cap (μF)	V	250		315		350		400		450	
		Item	D x L	R.C.	D x L	R.C.	D x L	R.C.	D x L	R.C.	D x L
68										25x30	0.38
100						25x30	0.50	25x30	0.50	25x40	0.50
150				25x30	0.61	25x40	0.69	25x40	0.62	25x50	0.68
220		25x30	0.75	25x40	0.84	25x50	0.91	25x50	0.81	30x50	0.88
330		25x40	1.02	25x50	1.12	25x60	1.21	30x60	1.15	35x60	1.24
470		25x50	1.34	25x60	1.43	30x60	1.54	35x60	1.47	35x80	1.65
680		30x50	1.73	30x60	1.85	35x60	1.98	35x80	1.98	35x100	2.18
1000		30x60	2.25	35x70	2.56	35x100	2.95	40x100	2.78	51x80	2.77
1500		35x80	3.21	35x100	3.54	40x100	3.72	51x105	3.69		
2200		35x100	4.19	40x100	4.41	51x105	4.86				
3300		51x80	5.24	51x105	5.82						

LM

LG series

- 105°C 2000hours, LUG terminal type.
- High temperature, high ripple current resistance.
- Suitable for machinery, filter circuit of tele-communication.
- RoHS Compliance
- 105°C 2000小時插片式電容。
- 耐高溫、高紋波電流。
- 適用於機械、通訊設備的濾波迴路。



SPECIFICATIONS

Items 項目	Characteristics 特性				
Capacitance Tolerance 靜電容量誤差	± 20%(120Hz,20°C)				
Operating Temperature Range 適用溫度範圍	-40 ~ +105°C		-25 ~ +105°C		
Rated Voltage Range 額定電壓範圍	16 ~ 250VDC		315 ~ 450VDC		
Leakage Current 洩漏電流	I ≤ 0.02CV(µA)or 5mA, whichever is smaller. (After 5 minutes application of DC rated voltage, at 20 °C)				
CV	Measurement Frequency: 120Hz. Temperature: 20°C				
	Rated Voltage(V)	16~25	35~50	63~315	350~450
	tan δ(Max)	0.35	0.25	0.20	0.25
	When nominal capacitance over 1000µF, tanδ shall be added 0.01 to the listed value with increase of every 1000µF .				
Low Temperature Stability 低溫特性 Impedance Ratio(Max) 阻抗比率(最大值)	Measurement Frequency: 120Hz.				
	Rated Voltage(V)	16~100	160~250	315~450	
	Z(-25°C)/Z(20°C)	6	4	8	
	Z(-40°C)/Z(20°C)	12	8	-	
Load Life 負荷壽命	The following specifications shall be satisfied when the capacitors are restored to 20°C after subjected to DC voltage with the rated ripple current is applied for 2,000 hours at 105°C.				
	Capacitance Change	Within ± 25% of Initial Value			
	tan δ	200% or less of Initial Specified Value			
	Leakage Current	Initial Specified Value or less			
Shelf Life 放置壽命	The following specifications shall be satisfied when the capacitors are restored to 20°C after exposing them for 1,000 hours 105°C without voltage applied. Before the measurement, the capacitor shall be preconditioned by applying voltage according to them 4.1 of JIS C5101-4.				
	Capacitance Change	Within ± 25% of Initial Value			
	tan δ	200% or less of Initial Specified Value			
	Leakage Current	Initial Specified Value or less			
Standards 參照標準	JIS C 5101-4 (IEC 60384)				

Frequency Coefficient of Permissible Ripple Current

Rated Voltage (V)	Frequency (Hz)			
	50	120	1K	≥ 10K
16 ~ 100	0.90	1.00	1.20	1.25
160 ~ 315	0.95	1.00	1.20	1.25
350 ~ 450	0.98	1.00	1.15	1.20

The endurance of capacitors is reduced with internal heating produced by ripple current at the rate of halving the lifetime with every 5°C rise. When long life performance is required in actual use , the rms ripple current has to be reduced.

LG series

DIMENSIONS(mm)

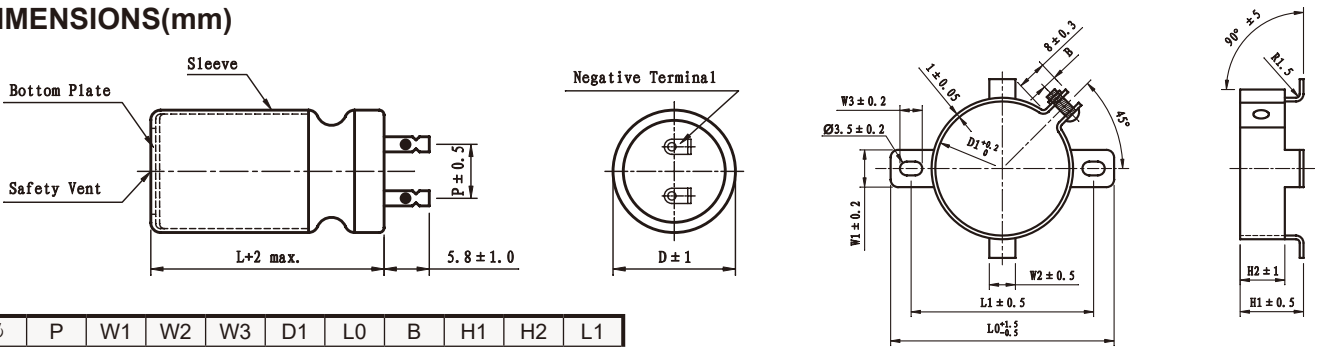

ϕ	P	W1	W2	W3	D1	L0	B	H1	H2	L1
25	10.0	11.0	3.5	6.0	25.4	48.0	3.5	10.0	8.0	38.0
30	10.0	11.0	3.5	6.0	30.0	52.0	4.0	11.0	9.0	42.0
35	14.0	11.0	3.5	6.0	34.9	58.0	3.5	15.0	10.0	48.0
40	18.0	14.0	3.5	7.0	40.0	65.0	3.0	18.5	12.5	53.5

STANDARD RATINGS

D×L(mm) ; R.C.(A rms) at 105°C 120Hz

Cap (μF)	V	16		25		35		50		63		80		100	
		Item	D x L	R.C.	D x L	R.C.	D x L	R.C.	D x L	R.C.	D x L	R.C.	D x L	R.C.	D x L
470										25x25	0.60	25x25	0.62	25x25	0.85
680										25x25	0.80	25x25	1.03	25x25	1.10
1000						25x25	0.50	25x25	0.80	25x25	1.10	25x35	1.30	25x40	1.40
1500						25x25	0.80	25x25	1.10	25x25	1.50	25x35	1.70	25x40	1.80
2200		25x25	0.70	25x25	1.00	25x35	1.30	25x35	1.60	25x35	1.70	25x50	1.90	30x50	2.40
3300		25x25	1.02	25x30	1.40	25x40	1.80	25x50	2.10	30x50	2.30	30x60	2.60	30x60	2.80
4700		25x30	1.50	25x35	1.90	25x50	2.00	30x50	2.60	30x60	2.80	35x60	3.10	40x60	3.70
6800		25x35	2.01	25x50	2.40	30x50	2.70	35x50	3.00	35x60	3.20	40x60	3.90	40x80	5.10
10000		25x50	2.40	30x50	2.90	30x60	3.20	35x60	4.40	40x60	4.90	40x80	5.80		

Cap (μF)	V	160		200		250		315		350		400		450	
		Item	D x L	R.C.	D x L	R.C.	D x L	R.C.	D x L	R.C.	D x L	R.C.	D x L	R.C.	D x L
22														25x35	0.15
33														25x50	0.21
47												25x40	0.21	25x50	0.22
100						25x50	0.43	25x50	0.44	25x50	0.45	30x50	0.48	30x60	0.53
150						25x50	0.51	25x50	0.62	25x50	0.61	30x50	0.61	30x60	0.61
220		25x50	0.64	30x50	0.71	30x50	0.72	35x50	0.82	35x60	0.82	35x80	0.82	35x80	0.92
330		30x50	0.92	30x60	0.92	35x60	1.03	35x80	1.05	35x80	1.10	40x80	1.10		
470		30x60	1.20	35x60	1.20	35x80	1.30	40x80	1.40	40x80	1.50				
680		35x60	1.60	40x60	1.70	40x80	1.80								
1000		35x80	2.20												

LP series

- 85°C 3000hours, Screw terminal type.
- High ripple current resistance.
- Suitable for industrial machinery, power converter, communication sets and test equipment.
- RoHS Compliance
- 85°C 3000小時螺絲型端子。
- 耐高紋波電流。
- 適用於工業機械、電源轉換器、通訊或檢測設備。



SPECIFICATIONS

Items 項目	Characteristics 特性										
Capacitance Tolerance 靜電容量誤差	± 20%(120Hz,20°C)										
Operating Temperature Range 適用溫度範圍	-40 ~ +85°C						-25 ~ +85°C				
Rated Voltage Range 額定電壓範圍	16 ~ 250VDC						350 ~ 500VDC				
Leakage Current 洩漏電流	I ≤ 0.02CV (µA) or 5mA, whichever is smaller (After 5minutes application of DC rated voltage, at 20°C)										
Dissipation Factor 散逸因素 (tan δ)	Measurement Frequency: 120Hz. Temperature: 20°C										
	Rated Voltage(V)	16	25	35	50	63	80	100	160~250	350~500	
	tan δ(Max)	35Ø	0.70	0.45	0.40	0.30	0.25	0.25	0.20	0.20	0.25
		51Ø	0.90	0.60	0.60	0.45	0.35	0.30	0.20	0.20	0.25
		64Ø	1.30	0.90	0.80	0.50	0.40	0.35	0.25	0.20	0.25
		76Ø	2.00	1.20	0.90	0.70	0.50	0.40	0.35	0.25	0.25
90Ø		-	-	-	-	-	-	-	0.25	0.25	
Low Temperature Stability 低溫特性	Measurement Frequency: 120Hz.										
Impedance Ratio(Max) 阻抗比率(最大值)	Rated Voltage(V)	16~250					350~500				
	Z(-25°C)/Z(20°C)	-					8				
	Z(-40°C)/Z(20°C)	12					-				
Load Life 負荷壽命	The following specifications shall be satisfied when the capacitors are restored to 20°C after subjected to DC voltage with the rated ripple current is applied for 3,000 hours at 85°C.										
	Capacitance Change	Within ± 15% of Initial Value									
	tan δ	175% or less of Initial Specified Value									
	Leakage Current	Initial Specified Value or less									
Shelf Life 放置壽命	The following specifications shall be satisfied when the capacitors are restored to 20°C after exposing them for 1,000 hours 85°C without voltage applied. Before the measurement, the capacitor shall be preconditioned by applying voltage according to them 4.1 of JIS C5101-4.										
	Capacitance Change	Within ± 15% of Initial Value									
	tan δ	175% or less of Initial Specified Value									
	Leakage Current	Initial Specified Value or less									
Standards 參照標準	JIS C 5101-4 (IEC 60384)										

Frequency Coefficient of Permissible Ripple Current

Rated Voltage (V)	Frequency (Hz)			
	50	120	1K	≥ 10K
16 ~ 100	0.90	1.00	1.15	1.15
160 ~ 250	0.88	1.00	1.15	1.20
350 ~ 500	0.82	1.00	1.30	1.40

The endurance of capacitors is reduced with internal heating produced by ripple current at the rate of halving the lifetime with every 10°C rise. When long life performance is required in actual use, the rms ripple current has to be reduced.

LP series

DIMENSIONS(mm)

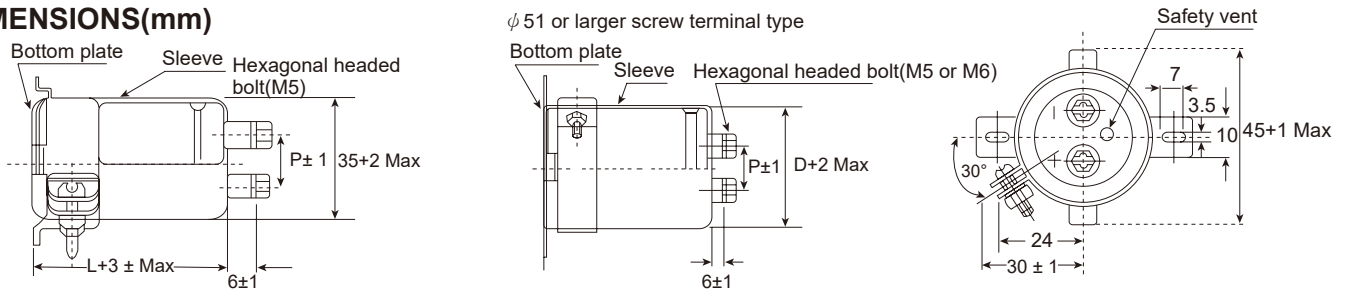

DIMENSIONS OF TERMINAL PITCH(P)

Case dia. (mm)	P (mm)
35	12.7
51	22.0
64	28.6
76	31.8
90	31.8

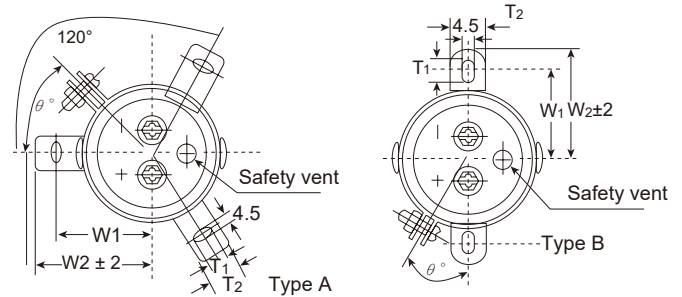

DIMENSIONS OF MOUNTING BRACKET

Cap (μF)	Leg shape	3-Legs				2-Legs			
		φ D	φ 51	φ 64	φ 76	φ 90	φ 51	φ 64	φ 76
	W1	32.5	38	44	50.8	33.2	40.5	46.5	53
	W2	38	43	49.2	57	39.5	46.5	53	59
	T1	7	8	7	7	6	6	6	6
	T2	12	14	16	16	14	14	14	14
	θ°	60	60	60	60	30	30	30	30

STANDARD RATINGS

D×L(mm) ; R.C.(A rms) at 85°C 120Hz

Cap (μF)	V	16		25		35		50		63	
		Item	D x L	R.C.	D x L	R.C.	D x L	R.C.	D x L	R.C.	D x L
10000										35x80	4.0
15000								35x80	5.4	35x100	5.5
22000								35x100	6.0	35x120	7.0
33000				35x80	6.0	35x80	6.2	51x80	7.0	51x80	8.8
47000		35x80	6.4	35x100	8.2	35x120	8.2	51x100	8.6	51x120	11.7
68000		35x100	7.9	35x120	9.4	51x80	9.3	51x100	11.0	64x100	15.0
100000		35x120	10.6	51x100	12.0	51x120	13.6	64x100	14.2	64x140	20.8
150000		51x120	11.5	51x120	15.3	64x120	16.5	76x120	18.6	76x140	26.0
220000		51x120	15.6	64x120	18.9	76x100	20.1				
330000		64x120	25.0	76x120	23.2	76x150	24.8				
470000		76x120	30.5								
500000		76x160	32.0								

LP series

STANDARD RATINGS

D×L(mm) ; R.C.(A rms) at 85°C 120Hz

Cap (μF)	V Item	80		100		160		200		250	
		D x L	R.C.	D x L	R.C.	D x L	R.C.	D x L	R.C.	D x L	R.C.
1000										35x80	2.4
1500								35x80	2.9	35x100	3.0
2200						35x80	3.2	35x100	3.5	51x80	4.0
3300						35x120	4.7	51x80	4.8	51x100	5.4
4700				35x80	3.7	51x80	5.0	51x100	6.3	64x100	7.3
6800				35x100	4.5	51x100	6.4	51x140	7.3	64x120	8.9
10000		35x80	4.2	35x120	5.3	64x100	9.0	64x120	9.8	76x120	11.8
15000		35x120	6.0	51x80	6.0	76x100	12.0	76x120	13.0	90x150	16.4
22000		51x80	6.5	51x100	6.8	76x140	16.9	90x150	15.9		
33000		51x120	9.2	51x140	10.0	90x150	19.2				
47000		64x120	12.7	64x140	14.1						
68000		64x140	15.5	76x150	18.2						
100000		76x150	21.3								

Cap (μF)	V Item	350		400		450		500	
		D x L	R.C.	D x L	R.C.	D x L	R.C.	D x L	R.C.
470				35x80	2.0	35x80	2.0	51x75	2.2
680		35x80	2.5	35x100	2.6	35x120	2.9	51x100	3.1
1000		51x60	3.3	51x80	3.3	51x80	3.6	51x130	3.8
1200		51x80	3.6	51x80	4.2	51x100	4.2	64x100	4.6
1500		51x80	4.5	51x100	4.8	51x120	5.0	64x120	5.4
1800		51x100	5.1	51x120	5.4	64x100	5.4	64x130	5.8
2200		51x120	6.0	51x140	6.3	64x120	6.6	76x120	6.9
2700		51x140	6.9	64x120	7.2	64x140	7.5	76x150	7.9
3300		64x100	8.0	64x140	8.4	76x120	8.4	90x140	8.6
3900		64x120	9.0	76x100	8.7	76x150	9.6	90x150	10.0
4700		76x100	9.6	76x150	10.5	76x150	11.4	90x190	12.0
5600		76x120	11.4	76x150	12.3	76x150	13.2		
6800		76x150	13.5	76x150	13.5	90x150	14.4		
8200		76x150	15.0	90x150	15.9	90x150	15.9		
10000		90x150	16.8	90x150	17.7	90x190	17.5		
12000		90x150	18.4	90x190	20.7				
15000		90x190	22.8						

LS series

- Load life : 85°C 5000Hours Screw terminal type.
- Suitable for use in industrial equipment industrial power, solar pv inverter, wind power, Marine, heavy trucks, and other fields.
- RoHS Compliance
- 85°C 5000小時 螺絲型端子。
- 適用於工業設備工控電源，太陽能光伏逆變器，風力發電，船舶，重型卡車等領域。



SPECIFICATIONS

Items 項目	Characteristics 特性				
Capacitance Tolerance 靜電容量誤差	± 20%(120Hz,20°C)				
Operating Temperature Range 適用溫度範圍	- 25 ~ +85°C				
Rated Voltage Range 額定電壓範圍	350 ~ 500VDC				
Rated Capacitance Range 容量範圍	220 ~ 1,000,000µF				
Leakage Current 洩漏電流	I ≤ 0.02CV (µA) or 5mA, whichever is smaller. (After 5 minutes application of DC rated voltage, at 20 °C)				
Dissipation Factor 散逸因素(tan δ)	Measurement Frequency: 120Hz. Temperature: 20°C				
	Rated Voltage(V)	350	400	450	500
	tan δ(MAX)	0.15	0.15	0.15	0.15
Temperature Stability 溫度特性	Measurement Frequency: 120Hz.				
	Capacitance Change C(-25°C)/Z(20°C) ≥ 0.6				
Load Life 負荷壽命	The following specifications shall be satisfied when the capacitors are restored to 20°C after subjected to DC voltage with the rated ripple current is applied for 5,000 hours at 85°C.				
	Capacitance Change	Within ± 20% of Initial Value			
	tan δ	200% or less of Initial Specified Value			
	Leakage Current	Initial Specified Value or less			
Shelf Life 放置壽命	The following specifications shall be satisfied when the capacitors are restored to 20°C after exposing them for 500 hours 85°C without voltage applied. Before the measurement, the capacitor shall be preconditioned by applying voltage according to them 4.1 of JIS C5101-4.				
	Capacitance Change	Within ± 20% of Initial Value			
	tan δ	200% or less of Initial Specified Value			
	Leakage Current	Initial Specified Value or less			
Standards 參照標準	JIS C 5101-4-1 (IEC 60384)				

Frequency Coefficient of Permissible Ripple Current

Rated Voltage (V)	Frequency (Hz)				
	50	120	300	1K	≥10K
350 ~ 500	0.80	1.00	1.20	1.30	1.40

The endurance of capacitors is reduced with internal heating produced by ripple current at the rate of halving the lifetime with every 10°C rise. When long life performance is required in actual use , the rms ripple current has to be reduced.

LS series

DIMENSIONS(mm)

Screw terminal type for $\phi 51$ and larger

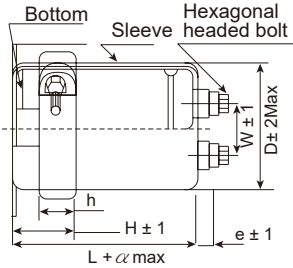

3-leg brackets for $\phi 90$ capacitors have different note shapes from the ordinary ones as illustrated below.

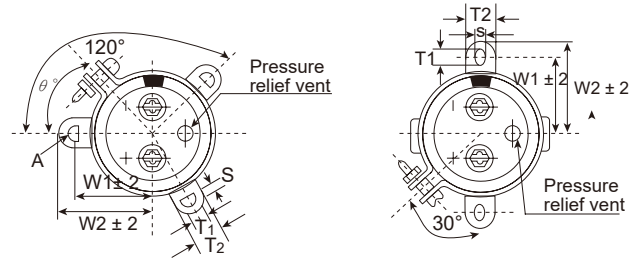
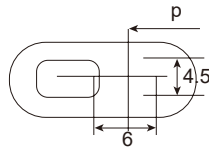

TERMINAL PITCH(W) & LENGTH (e) TABLE

ϕD	W	e	α
51	22	6	3
64	28.6	6	3
76	31.8	6	3
90	31.8	6	3
100	41.5	10	4

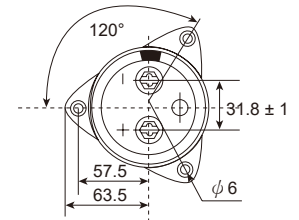
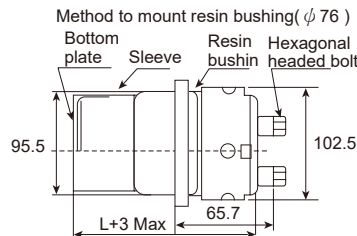
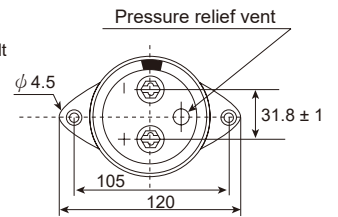
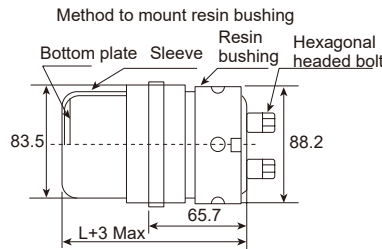

DIMENSIONS OF MOUNTING BRACKET

Cap (μF)	Leg shape	3-Legs					2-Legs			
		ϕD	$\phi 51$	$\phi 64$	$\phi 76$	$\phi 90$	$\phi 100$	$\phi 51$	$\phi 64$	$\phi 76$
	W_1	32.5	38	44.5	50.8	56.3	33.2	40.5	46.5	53
	W_2	38.5	43	49.2	57	62	40	46.5	53	59
	T_1	7.5	8.0	7.0	7.0	8.0	6.0	6.0	6.0	6.0
	T_2	12	14	14	14	16	14	14	14	14
	S	5.0	5.0	5.0	5.0	5.0	4.5	4.5	4.5	4.5
	θ°	60	60	60	60	60	30	30	30	30
	H	20	25	30	35	36	25	35	35	35
	h	15	20	24	20	30	15	20	20	20

STANDARD RATINGS

D×L(mm) ; R.C.(A rms) at 85°C 120Hz

Cap (μF)	V	350		400		450		500	
		Item	D x L	R.C.	D x L	R.C.	D x L	R.C.	D x L
1500								64x115	8.6
1800						64x95	6.7	64x130	10.0
2200						64x100	10.4	64x155	11.7
						76x95	11.5		
2700				64x100	11.5	64x130	12.8	76x120	15
3300				64x130	14.2	64x155	15.2	76x145	17.5
						76x120	15.8		
3900	64x115	14.6		64x155	16.5	64x155	16.5	76x155	20.2
				76x120	17.2	76x120	18.0		
4700	64x130	16.9		64x155	18.1	76x145	20.8	90x135	21.8
				76x130	20.8	90x120	21.8		
5600	64x155	19.8		76x140	22.7	76x160	24.2	90x160	25.3
	76x120	21.6		90x120	23.8	90x135	24.9		
6800	76x145	25.0		76x160	26.6			90x175	29.0
	90x120	26.2		90x135	27.4	90x160	29.4		
8200	76x160	29.3							
	90x135	30.1		90x160	32.2	90x160	32.2		
10000	90x160	35.7		90x160	35.7	90x175	36.9		
12000	90x160	39.1							

LV series

- Load life : 85°C 5000Hours high voltage Screw terminal type.
- Suitable for use in industrial equipment industrial power, solar pv inverter, wind power, Marine, heavy trucks, and other fields.
- RoHS Compliance
- 85°C 5000小時 耐高壓螺栓型端子。
- 適用於在工業設備工控電源，太陽能光伏逆變器，風力發電，船舶，重型卡車等領域。



SPECIFICATIONS

Items 項目	Characteristics 特性				
Capacitance Tolerance 靜電容量誤差	± 20%(120Hz,20°C)				
Operating Temperature Range 適用溫度範圍	- 25 ~ +85°C				
Rated Voltage Range 額定電壓範圍	500 ~ 650VDC				
Rated Capacitance Range 容量範圍	220 ~ 1,000,000µF				
Leakage Current 洩漏電流	I ≤ 0.02CV (µA) or 5mA, whichever is smaller. (After 5 minutes application of DC rated voltage, at 20 °C)				
Dissipation Factor 散逸因素(tan δ)	Measurement Frequency: 120Hz. Temperature: 20°C				
	Rated Voltage(V)	500	550	600	650
	tan δ(MAX)	0.25	0.25	0.25	0.25
Temperature Stability 溫度特性	Measurement Frequency: 120Hz.				
	Capacitance Change C(-25°C)/Z(20°C) ≥ 0.6				
Load Life 負荷壽命	The following specifications shall be satisfied when the capacitors are restored to 20°C after subjected to DC voltage with the rated ripple current is applied for 5,000 hours at 85°C.				
	Capacitance Change	Within ± 20% of Initial Value			
	tan δ	200% or less of Initial Specified Value			
	Leakage Current	Initial Specified Value or less			
Shelf Life 放置壽命	The following specifications shall be satisfied when the capacitors are restored to 20°C after exposing them for 500 hours 85°C without voltage applied. Before the measurement, the capacitor shall be preconditioned by applying voltage according to them 4.1 of JIS C5101-4.				
	Capacitance Change	Within ± 20% of Initial Value			
	tan δ	200% or less of Initial Specified Value			
	Leakage Current	Initial Specified Value or less			
Standards 參照標準	JIS C 5101-4-1 (IEC 60384)				

Frequency Coefficient of Permissible Ripple Current

Rated Voltage (V)	Frequency (Hz)				
	50	120	360	1K	≥3K
500 ~ 650	0.80	1.00	1.20	1.30	1.40

The endurance of capacitors is reduced with internal heating produced by ripple current at the rate of halving the lifetime with every 10°C rise. When long life performance is required in actual use , the rms ripple current has to be reduced.

LV series

DIMENSIONS(mm)

Screw terminal type for $\phi 51$ and larger

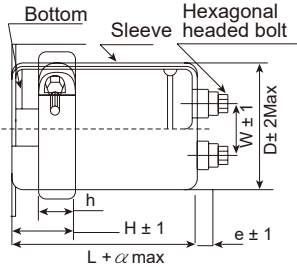

3-leg brackets for $\phi 90$ capacitors have different hole shapes from the ordinary ones as illustrated below.

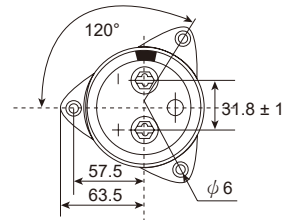
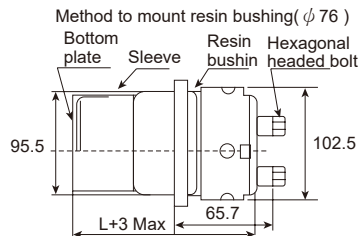
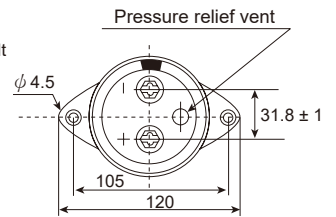
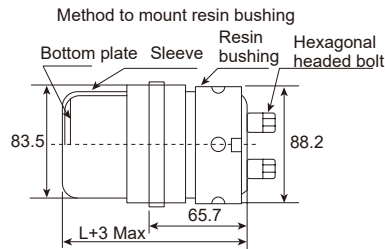
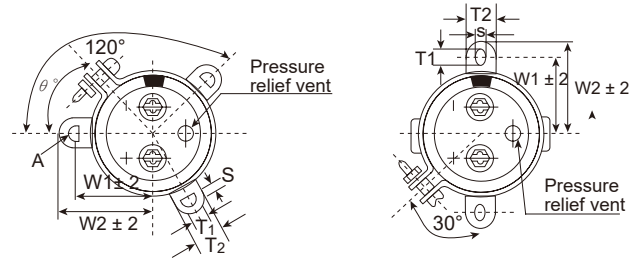
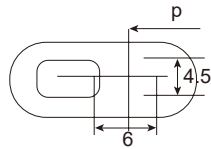

TERMINAL PITCH(W) & LENGTH (e) TABLE

ϕD	W	e	α
51	22	6	3
64	28.6	6	3
76	31.8	6	3
90	31.8	6	3
100	41.5	10	4

DIMENSIONS OF MOUNTING BRACKET

mm

Cap (μF)	Leg shape	3-Legs					2-Legs			
		$\phi 51$	$\phi 64$	$\phi 76$	$\phi 90$	$\phi 100$	$\phi 51$	$\phi 64$	$\phi 76$	$\phi 90$
	W_1	32.5	38	44.5	50.8	56.3	33.2	40.5	46.5	53
	W_2	38.5	43	49.2	57	62	40	46.5	53	59
	T_1	7.5	8.0	7.0	7.0	8.0	6.0	6.0	6.0	6.0
	T_2	12	14	14	16	16	14	14	14	14
	S	5.0	5.0	5.0	5.0	5.0	4.5	4.5	4.5	4.5
	θ°	60	60	60	60	60	30	30	30	30
	H	20	25	30	35	36	25	35	35	35
	h	15	20	24	20	30	15	20	20	20

STANDARD RATINGS

D×L(mm) ; R.C.(A rms) at 85°C 120Hz

Cap (μF)	V	500		550		600		650	
		D x L	R.C.	D x L	R.C.	D x L	R.C.	D x L	R.C.
1000				51x95	5.4			64x100	6.3
1200		51x95	5.9	51x110	6.3	64x95	6.7	64x110	7.2
1500		51x115	7.2	51x130	7.6	64x110	8.0	64x130	8.6
1800		51x130	8.3	64x105	8.6	64x125	9.3	64x150	10.1
2200		51x150	9.8	64x120	10.1	64x145	11	64x170	11.7
2700		64x120	11.2	64x150	12.4	64x170	13.1	76x150	13.6
				76x105	11.7	76x125	12.6		
3300		64x140	13.3	64x170	14.5	76x145	14.9	76x170	15.8
				76x130	14.2				
3900		64x170	15.7	76x140	15.9	76x170	17.3	90x155	15.3
		76x130	15.4			90x130	14.2		
4700		76x150	18.1	76x170	19.1	76x190	20.0	90x190	18.4
				90x130	15.6	90x150	16.6		
5600		76x170	20.8	90x150	18.2	90x170	19.1		
		90x130	17.1						
6800		90x150	20	90x170	21.1				
8200		90x190	24.4	100x170	24.8				
10000		90x210	28.2	100x200	29.4				
12000		100x210	32.9						
15000		100x250	39.8						

LV

LW series

- Load life : 85°C 10000Hours Screw terminal type.
- Suitable for use in industrial equipment industrial power, solar pv inverter, wind power, Marine, heavy trucks, and other fields.
- RoHS Compliance
- 85°C 10000小時 螺絲型端子。
- 適用於工業設備工控電源，太陽能光伏逆變器，風力發電，船舶，重型卡車等領域。



SPECIFICATIONS

Items 項目	Characteristics 特性			
Capacitance Tolerance 靜電容量誤差	± 20%(120Hz,20°C)			
Operating Temperature Range 適用溫度範圍	- 25 ~ +85°C			
Rated Voltage Range 額定電壓範圍	350 ~ 450VDC			
Rated Capacitance Range 容量範圍	220 ~ 1,000,000µF			
Leakage Current 洩漏電流	I ≤ 0.02CV (µA) or 5mA, whichever is smaller. (After 5 minutes application of DC rated voltage, at 20 °C)			
Dissipation Factor 散逸因素(tan δ)	Measurement Frequency: 120Hz. Temperature: 20°C			
	Rated Voltage(V)	350	400	450
	tan δ(MAX)	0.15	0.15	0.15
Temperature Stability 溫度特性	Measurement Frequency: 120Hz.			
	Capacitance Change C(-25°C)/Z(20°C) ≥ 0.6			
Load Life 負荷壽命	The following specifications shall be satisfied when the capacitors are restored to 20°C after subjected to DC voltage with the rated ripple current is applied for 10,000 hours at 85°C.			
	Capacitance Change	Within ± 20% of Initial Value		
	tan δ	200% or less of Initial Specified Value		
	Leakage Current	Initial Specified Value or less		
Shelf Life 放置壽命	The following specifications shall be satisfied when the capacitors are restored to 20°C after exposing them for 500 hours 85°C without voltage applied. Before the measurement, the capacitor shall be preconditioned by applying voltage according to them 4.1 of JIS C5101-4.			
	Capacitance Change	Within ± 20% of Initial Value		
	tan δ	200% or less of Initial Specified Value		
	Leakage Current	Initial Specified Value or less		
Standards 參照標準	JIS C 5101-4-1 (IEC 60384)			

Frequency Coefficient of Permissible Ripple Current

Rated Voltage (V)	Frequency (Hz)				
	50	120	300	1K	≥10K
350 ~ 450	0.80	1.00	1.20	1.30	1.40

The endurance of capacitors is reduced with internal heating produced by ripple current at the rate of halving the lifetime with every 10°C rise. When long life performance is required in actual use , the rms ripple current has to be reduced.

LW

LW series

DIMENSIONS(mm)

Screw terminal type for $\phi 51$ and larger

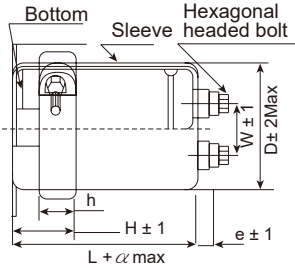

3-leg brackets for $\phi 90$ capacitors have different note shapes from the ordinary ones as illustrated below.

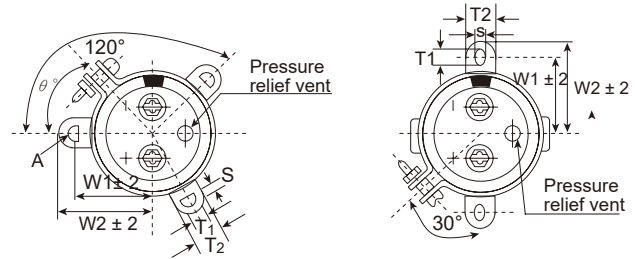
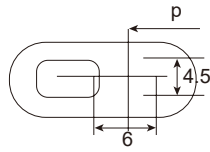

TERMINAL PITCH(W) & LENGTH (e) TABLE

ϕD	W	e	α
51	22	6	3
64	28.6	6	3
76	31.8	6	3
90	31.8	6	3
100	41.5	10	4

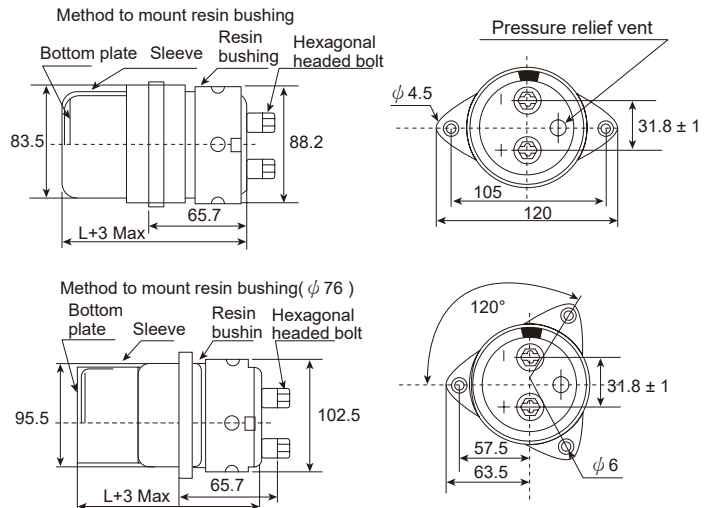

DIMENSIONS OF MOUNTING BRACKET

Cap (μF)	Leg shape	3-Legs					2-Legs			
		ϕD	$\phi 51$	$\phi 64$	$\phi 76$	$\phi 90$	$\phi 100$	$\phi 51$	$\phi 64$	$\phi 76$
	W_1	32.5	38	44.5	50.8	56.3	33.2	40.5	46.5	53
	W_2	38.5	43	49.2	57	62	40	46.5	53	59
	T_1	7.5	8.0	7.0	7.0	8.0	6.0	6.0	6.0	6.0
	T_2	12	14	14	16	16	14	14	14	14
	S	5.0	5.0	5.0	5.0	5.0	4.5	4.5	4.5	4.5
	θ°	60	60	60	60	60	30	30	30	30
	H	20	25	30	35	36	25	35	35	35
	h	15	20	24	20	30	15	20	20	20

STANDARD RATINGS

D×L(mm) ; R.C.(A rms) at 85°C 120Hz

Cap (μF)	V	350		400		450		
		Item	D x L	R.C.	D x L	R.C.	D x L	R.C.
1000			51x85	5.5	51x85	5.0	51x85	5.0
1200			51x85	5.5	51x85	5.5	51x95	6.0
1500			51x85	6.1	51x95	6.7	51x115	7.2
1800			51x95	7.4	51x95	7.4	51x130	8.3
2200			51x95	8.2	51x130	9.2	64x95	9.0
2700			51x130	10.2	64x95	9.9	64x115	10.7
3300			51x130	11.3	64x115	11.8	64x130	12.4
3900			64x115	12.8	64x130	13.5	76x115	13.6
4700			64x130	14.8	76x115	14.9	76x130	15.6
5600			76x115	16.3	76x130	17.0	76x155	18.3
6800			76x130	18.8	76x155	20.2	90x155	21.4
8200			76x155	22.1	90x155	23.5	90x155	23.5
10000			90x155	25.9	90x155	25.9	90x195	28.3
12000			90x155	28.4	90x195	31.0		
15000			90x195	34.6				

HP series

- 105°C 5000hours, Screw terminal type.
- High temperature, high ripple current resistance and long life.
- RoHS Compliance
- 105°C 5000小時螺栓型端子。
- 耐高溫、高紋波電流、長壽命。



SPECIFICATIONS

Items 項目	Characteristics 特性												
Capacitance Tolerance 靜電容量誤差	± 20%(120Hz,20°C)												
Operating Temperature Range 適用溫度範圍	- 40 ~ +105°C						- 25 ~ +105°C						
Rated Voltage Range 額定電壓範圍	10 ~ 100VDC						160 ~ 450VDC						
Rated Capacitance Range 容量範圍	220 ~ 1,000,000µF												
Leakage Current 洩漏電流	I ≤ 0.02CV (µA) or 5mA, whichever is smaller. (After 5 minutes application of DC rated voltage, at 20 °C)												
Dissipation Factor 散逸因素 (tan δ)	Measurement Frequency: 120Hz. Temperature: 20°C												
	Rated Voltage(V)		10	16	25	35	50	63	80	100	160~250	350~450	
	tan δ (MAX)	35Ø	80~140	0.65	0.45	0.40	0.30	0.25	0.25	0.20	0.12	0.15	0.20
		51Ø	80~140	0.90	0.60	0.50	0.40	0.25	0.25	0.20	0.15	0.15	0.20
		64Ø	120~190	1.20	0.80	0.70	0.50	0.35	0.30	0.25	0.20	0.20	0.20
		76Ø	120~190	2.00	1.20	0.90	0.70	0.55	0.50	0.35	0.30	0.20	0.20
90Ø		150~190	2.40	2.00	1.50	1.00	0.75	0.60	0.40	0.30	0.25	0.20	
100Ø	220	2.00	2.00	1.50	1.00	0.75	0.60	0.40	0.30	0.25	0.20		
Low Temperature Stability 低溫特性	Measurement Frequency: 120Hz.												
Impedance Ratio(Max) 阻抗比率(最大值)	Rated Voltage(V)	10~100						160~450					
	Z(-25°C)/Z(20°C)	-						8					
	Z(-40°C)/Z(20°C)	12						-					
Load Life 負荷壽命	The following specifications shall be satisfied when the capacitors are restored to 20°C after subjected to DC voltage with the rated ripple current is applied for 5,000 hours (10~250V,2000 hours) at 105°C.												
	Capacitance Change	Within ± 20% of Initial Value											
	tan δ	300% or less of Initial Specified Value											
	Leakage Current	Initial Specified Value or less											
Shelf Life 放置壽命	The following specifications shall be satisfied when the capacitors are restored to 20°C after exposing them for 1,000 hours 105°C without voltage applied. Before the measurement, the capacitor shall be preconditioned by applying voltage according to them 4.1 of JIS C5101-4.												
	Capacitance Change	Within ± 20% of Initial Value											
	tan δ	300% or less of Initial Specified Value											
	Leakage Current	Initial Specified Value or less											
Standards 參照標準	JIS C 5101-4 (IEC 60384)												

Frequency Coefficient of Permissible Ripple Current

Rated Voltage (V)	Frequency (Hz)				
	60	120	360	1K	≥10K
10 ~ 100	0.90	1.00	1.08	1.15	1.15
160 ~ 250	0.88	1.00	1.08	1.15	1.20
350 ~ 450	0.82	1.00	1.20	1.35	1.40

The endurance of capacitors is reduced with internal heating produced by ripple current at the rate of halving the lifetime with every 5°C rise. When long life performance is required in actual use, the rms ripple current has to be reduced.

HP series

DIMENSIONS(mm)

Screw terminal type for $\phi 51$ and larger

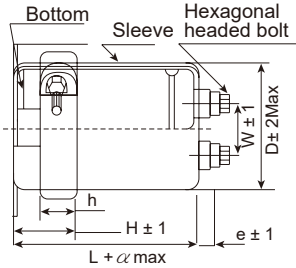

3-leg brackets for $\phi 90$ capacitors have different note shapes from the ordinary ones as illustrated below.

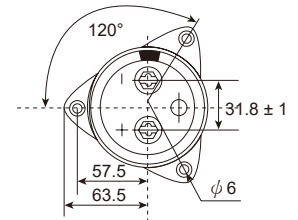
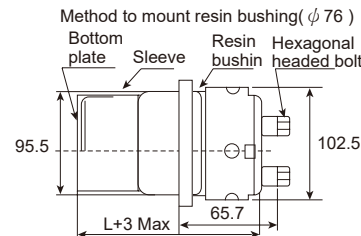
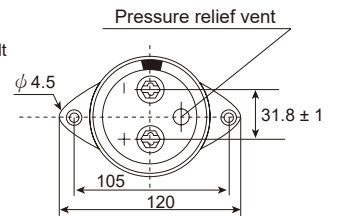
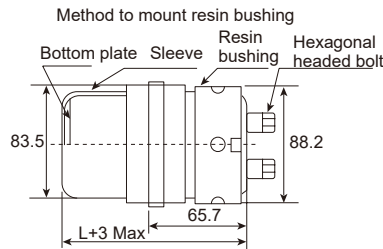
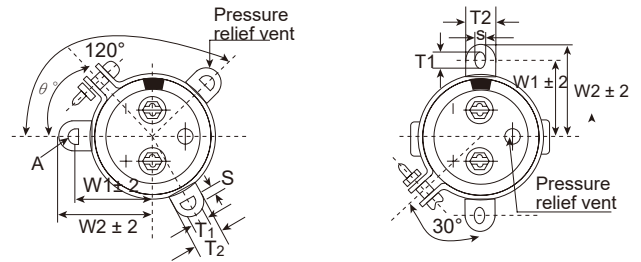
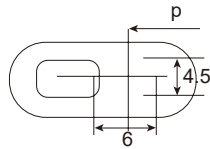

TERMINAL PITCH(W) & LENGTH (e) TABLE

ϕD	W	e	α
35	12.7	/	3
51	22.0	6	3
64	28.6	6	3
76	31.8	6	3
90	31.8	6	3
100	41.5	10	4

DIMENSIONS OF MOUNTING BRACKET

Cap (μF)	Leg shape	3-Legs					2-Legs					
		ϕD	$\phi 51$	$\phi 64$	$\phi 76$	$\phi 90$	$\phi 100$	$\phi 35$	$\phi 51$	$\phi 64$	$\phi 76$	$\phi 90$
	W_1		32.5	38	44.5	50.8	56.3	24	33.2	40.5	46.5	53
	W_2		38.5	43	49.2	57	62	30	40	46.5	53	59
	T_1		7.5	8.0	7.0	7.0	8.0	6	6.0	6.0	6.0	6.0
	T_2		12	14	14	16	16	10	14	14	14	14
	S		5.0	5.0	5.0	5.0	5.0	3.5	4.5	4.5	4.5	4.5
	θ°		60	60	60	60	60	30	30	30	30	30
	H		20	25	30	35	36	16	25	35	35	35
	h		15	20	24	20	30	12	15	20	20	20

STANDARD RATINGS

D×L(mm) ; R.C.(A rms) at 105°C 120Hz

Cap (μF)	V	10		16		25		35	
		Item	D x L	R.C.	D x L	R.C.	D x L	R.C.	D x L
10000								35x100	4.3
15000								35x100	5.0
22000						35x100	4.4	35x120	5.2
33000		35x80	4.7	35x80	4.8	35x120	6.0	35x140	7.0
47000		35x100	6.0	35x100	6.0	51x100	8.0	51x120	8.0
68000		51x80	6.5	51x80	6.5	51x140	10.0	51x140	12.0
100000		51x100	8.2	51x100	9.0	64x120	11.0	64x140	13.2
150000		51x120	10.2	51x120	11.4	64x140	13.5	76x150	15.0
220000		64x120	13.0	64x120	14.5	76x150	16.5	90x150	17.1
330000		76x120	15.2	76x120	17.0	90x150	20.2	90x190	21.0
470000		90x140	16.0	90x140	20.2	90x190	22.0		
680000		90x170	18.0	90x170	22.0				
1000000		90x180	20.0	90x190	23.5				

HP series

STANDARD RATINGS

D×L(mm) ; R.C.(A rms) at 105°C 120Hz

Cap (μF)	V Item	50		63		80		100	
		D x L	R.C.	D x L	R.C.	D x L	R.C.	D x L	R.C.
2200								35x100	2.0
3300								35x100	3.0
4700						35x100	3.1	35x120	3.4
6800						35x120	3.4	51x100	5.0
10000		35x100	4.5	35x120	4.5	51x100	5.0	51x120	6.2
15000		35x120	5.2	51x100	5.5	51x120	6.0	64x120	7.4
22000		51x100	6.0	51x120	6.5	64x120	8.0	76x120	9.5
33000		51x140	7.5	64x120	9.0	76x120	9.5	76x150	12.3
47000		64x120	9.5	64x140	11.0	76x150	13.0	90x150	16.5
68000		64x140	12.5	76x150	13.2	90x150	16.5	90x190	18.0
100000		76x150	16.5	90x150	17.3	90x190	18.2	100x220	20.2
150000		90x150	19.5	90x190	20.5	100x220	21.2		
220000		90x190	21.5	100x220	23.2				
330000		100x220	24.0						

Cap (μF)	V Item	160		200		250	
		D x L	R.C.	D x L	R.C.	D x L	R.C.
680						35x100	1.4
1000		35x100	1.6	35x100	1.7	35x120	1.9
1500		35x100	2.1	35x120	2.3	51x100	2.4
2200		35x120	2.7	51x100	2.9	51x120	3.2
3300		51x100	3.8	51x120	3.9	64x120	4.3
4700		51x120	4.5	64x120	5.1	64x140	5.9
6800		64x120	6.8	64x140	7.0	76x150	7.1
10000		64x150	7.8	76x150	8.2	90x150	9.6
15000		76x150	9.8	76x150	10.4	90x190	12.7
22000		76x150	12.5	90x150	15.1		
33000		90x150	13.4				

Cap (μF)	V Item	350		400		450	
		D x L	R.C.	D x L	R.C.	D x L	R.C.
220				35x100	1.2	35x100	1.4
330		35x100	2.0	35x100	2.0	35x120	2.0
470		35x100	2.4	35x120	3.0	51x100	3.0
680		51x100	4.0	51x100	4.0	51x120	4.0
1000		51x100	6.2	51x100	6.2	51x120	6.5
1500		51x120	8.2	51x140	9.0	51x140	9.0
2200		51x140	10.6	64x120	11.2	64x120	11.4
2700		64x120	12.2	64x120	13.0	64x140	13.4
						76x120	14.1
3300		64x120	14.0	64x140	15.0	64x170	16.2
						76x150	17.0
3900		64x140	16.4	64x170	17.5	64x190	18.0
				76x120	18.0		
4700		64x140	19.4	64x190	20.3	76x170	21.3
		76x150	19.3	76x150	20.0		
5600		76x150	22.0	76x170	23.3	76x190	26.0
						90x170	24.0
6800		76x170	26.0	76x190	27.2	90x190	28.0
				90x170	26.5		
8200		76x170	30.0	90x190	29.5		
		90x150	29.0				
10000		90x170	32.0				

HP

Taping Specification for Automatic insertion

APPLICATIONS

- These specifications include taped single-ended electrolytic capacitors with the body diameters from 4.0 to 16mm.
- Suitable to be used in automatic lead preparation and insertion machines.

DESCRIPTION

- Body tape requirements are shown from Fig.1 to Fig.6
- Polarity of capacitors shall be oriented in one direction.
- Leader tapes shall not be provided before the first and after the last capacitor on tape.
- Up to 3 capacitor consecutively missing on tape is permitted but a designed quantity of capacitors shall be packed in each case.
- Removal faulty capacitors from the tape shall be by pulling out or by cutting off leads. Cut off leads remaining on tape shall not protrude more than 2.0 mm from tape edge.

DIAGRAM OF TAPING DIMENSIONS

(Unit=mm)

Fig.1(φ 4-φ 8)

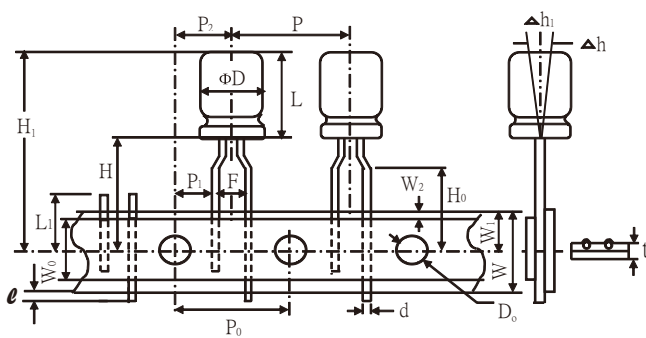

Fig.2(φ 4-φ 5)

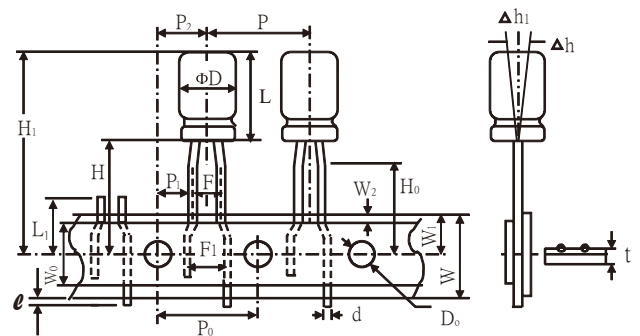

Fig.3(φ 5-φ 8)

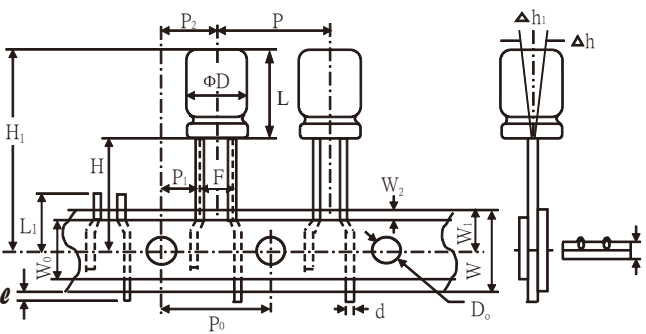

Fig.4(φ 10)

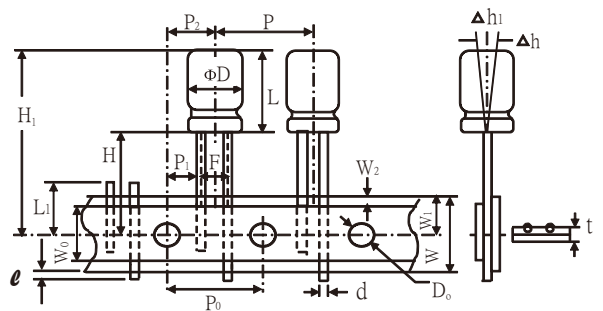

Fig.5(φ 12~φ 13)

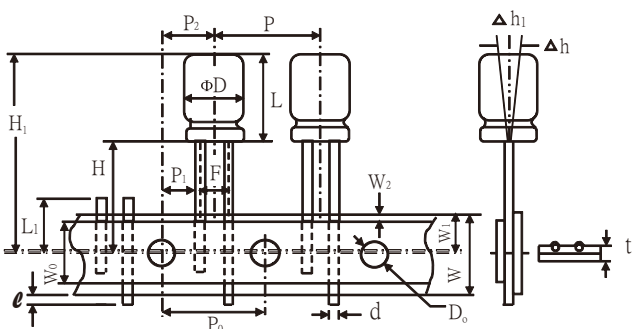
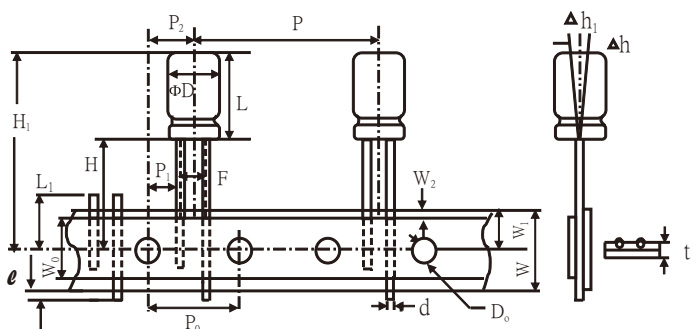

Fig.6(φ 16)



For Automatic Insertion Taping Capacitors

TAPING DIMENSIONS (mm)

Items	Symbol	Case Size									Tolerance	Remark			
		4x5	5x5		4x7	5x7		5x11	6.3x11	8x12			10x13	10x16	10x20
			6.3x5	8x5		6.3x7	8x7								
Lead Wire Diameter	d	0.45	0.45	0.45	0.5	0.5			0.6			±0.05			
Body Height	L	6		8		12		13	14	18	22	max			
Intervals of Bodies	P	12.7									±1.0				
Intervals of Punched Holes	P ₀	12.7									±0.2				
Distance between Holes and Lead Wire	P ₁	3.85									±0.7	Fig.1 Fig.4 Fig.2 Fig.3			
		5.35	5.10	5.10	5.10	5.10	5.10	5.10	5.10	5.10					
Distance between Holes and Body Center	P ₂	6.35									±1.0				
Distance between Lead and Lead	F	5.00									+0.8	Fig.1 Fig.4 Fig.2			
		2.5	2.5	2.5	2.5	2.5	2.5								
		1.5	2.0		2.5	2.5	2.0	2.5	3.5			-0.2	Fig.3		
Distance between Lead and Lead	F1	5.0										Fig.2 Fig.3			
Base Tape Width	W	18.0									±0.5				
Adhesive Tape Width	W ₀	10.0	10.0	10.0	10.0	10.0	12.0			min					
Deviation between Holes and Base Tape	W ₁	9.0									±0.5				
Deviation between Adhesive and Base Tape	W ₂	1.5									max				
Deviation between Body Bottom and Tape Center	H	17.5				18.5				±0.75	Fig.1 Fig.4 Fig.2 Fig.3				
		17.5	18.5	17.5	18.5	18.5									
Lead Wire Clinched Height	H ₀	15.0				16.0				±0.5					
		15.0	16.0	15.0	16.0										
Distance between Body Top and Tape Center	H ₁	27.5			32.5			33.0	36.0	41.0	max				
Punched Hole Diameter	D ₀	4.0									±0.3				
Lead Wire Protrusion	l	1.0									max				
Length of not Good Lead Slit	L ₁	11.0									max				
Base and Adhesive Tape Thickness	t	0.7									±0.2				
Deviation of Body Alignment	Δh	0									±2.0				
Deviation of Body Alignment	Δh ₁	0									±2.0				

TAPING DIMENSIONS (mm)

Items	Symbol	Case Size							Tolerance	Remark
		12.5x21	13x21	13x25	13x30	16x26	16x32	16x36		
Lead Wire Diameter	d	0.6			0.8				±0.05	
Body Height	L	23.0	23.0	27.0	32.0	28.0	34.0	38.0	max	
Intervals of Bodies	P	15.0				30.0			±1.0	
Intervals of punched Holes	P ₀	15.0							±0.2	
Distance between Holes and Lead Wire	P ₁	5.0				3.75			±0.7	
Distance between Holes and Bodies	P ₂	7.5							±1.0	
Distance between Lead and Lead	F	5.0				7.5			+0.8 -0.2	Fig.5 Fig.6
Base Tape Width	W	18.0				15.0			±0.5	
Adhesive Tape Width	W ₀	12.0				15.0			min	
Deviation between Holes and Base Tape	W ₁	9.0							±0.5	
Deviation between Adhesive and Base Tape	W ₂	1.5							max	
Deviation between Body Bottom and Tape Center	H	18.5							±0.75	Fig.5 Fig.6
Distance between Body Top and Tape Center	H ₁	40.5	40.5	45.5	50.5	46.5	53.5	56.5	max	
Punched Hole Diameter	D ₀	4.0							±0.3	
Lead Wire Protrusion	l	1.0							max	
Length of not Good Lead Slit	L ₁	11.0							max	
Base and Adhesive Tape Thickness	t	0.7							±0.2	
Deviation of Body Alignment	Δh	0							±2.0	
Deviation of Body Alignment	Δh ₁	0							±2.0	

Lead Cutting and Forming

With Terminals or Forms as below, Easier Inserting the Units into P.C. Board and Contributing to Higher Mounting Efficiency.

SHAPE (S)

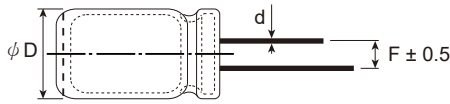

SHAPE (C)

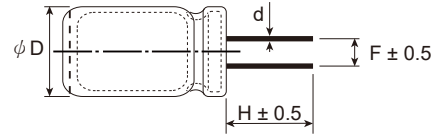

SHAPE (D)

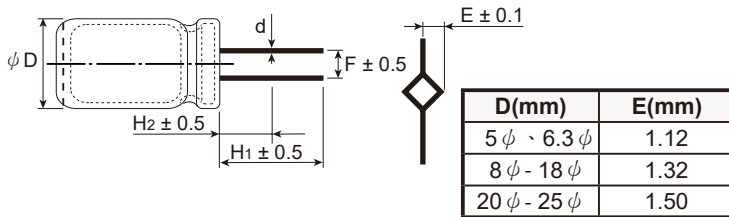

SHAPE (H)

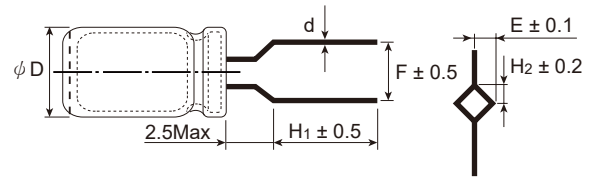

SHAPE (F)

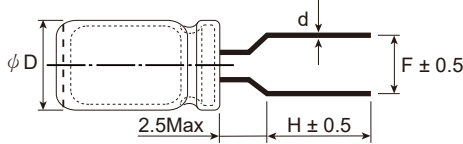

SHAPE (B)

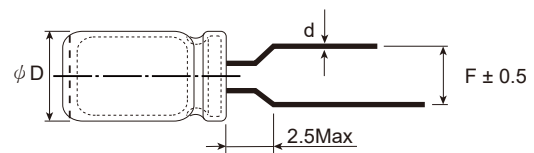

SHAPE (Z)

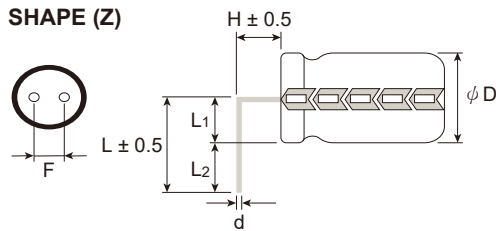

SHAPE (L)

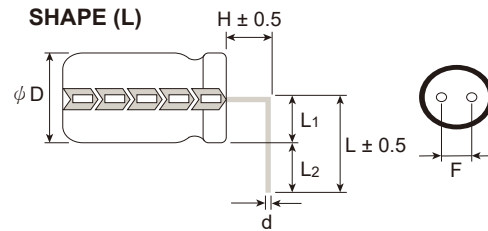

SPECIFICATION INFORMATION

Shape No.	Cutting & Forming Methods	D ϕ	4 ϕ	5 ϕ	6.3 ϕ	8 ϕ	10 ϕ	12.5 ϕ	13 ϕ	16 ϕ	18 ϕ	22 ϕ		
S	Long Lead	F	1.5	2.0	2.5	3.5	5	5	5	7.5	7.5	10		
		d	0.45	0.5	0.5	0.5	0.6	0.6	0.6	0.6	0.8	0.8	0.8	
C	Lead Cut Only	F	1.5	2.0	2.5	3.5	5.0	5.0	5.0	7.5	7.5	10.0		
		H	5.0	5.0	5.0	5.0	5.0	5.0	5.0	5.0	5.0	5.0		
		d	0.45	0.5	0.5	0.5	0.6	0.6	0.6	0.6	0.8	0.8	0.8	
D	Lead Cut and Crimp	F	—	—	—	—	5.0	5.0	5.0	7.5	7.5	10		
		H ₁	—	—	—	—	5.0	5.0	5.0	5.0	5.0	5.0		
		H ₂	—	—	—	—	1.8	1.8	1.8	1.8	1.8	1.8		
F	Lead Cut and Form	d	—	—	—	—	0.6	0.6	0.6	0.8	0.8	0.8		
		F	5.0	5.0	5.0	5.0	—	—	—	—	—	—		
		H	4.0	5.0	5.0	5.0	—	—	—	—	—	—		
H	Lead Cut, Crimp and Form	d	0.45	0.5	0.5	0.5	—	—	—	—	—	—		
		F	5.0	5.0	5.0	5.0	—	—	—	—	—	—		
		H ₁	4.0	5.0	5.0	5.0	—	—	—	—	—	—		
B	Forming Only	H ₂	1.8	1.8	1.8	1.8	—	—	—	—	—	—		
		d	0.45	0.5	0.5	0.5	—	—	—	—	—	—		
		F	5.0	5.0	5.0	5.0	—	—	—	—	—	—		
L / Z	Lead Cutting and Bending	d	0.45	0.5	0.5	0.5	—	—	—	—	—	—		
		F	1.5	2.0	2.5	3.5	5	5	5	7.5	7.5	10		
		H	2.0	2.0	2.0	2.5 or 3.5 or 5.0								
		L ₁	2.2	2.7	3.4	4.5	5.3	6.6	6.8	8.4	9.4	11.4		
		L ₂	3.5	3.5	3.5	3.5	3.5	3.5	3.5	3.5	3.5	3.5		

Terminals Diagram for Capacitors

(mm)

D= ϕ 22 to ϕ 35 mm

YL

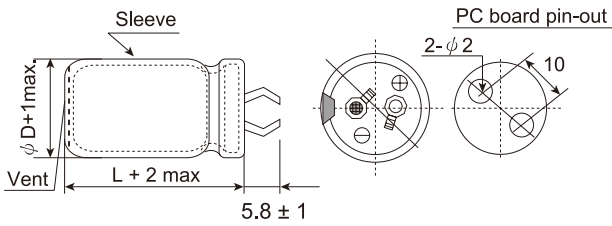

D= ϕ 22 to ϕ 35mm

YS

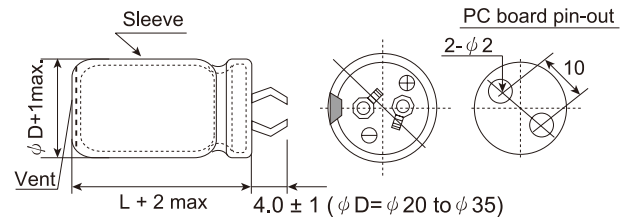

D= ϕ 25 to ϕ 51 mm

G

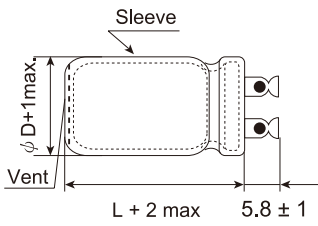

D= ϕ 35 to ϕ 51mm

ST

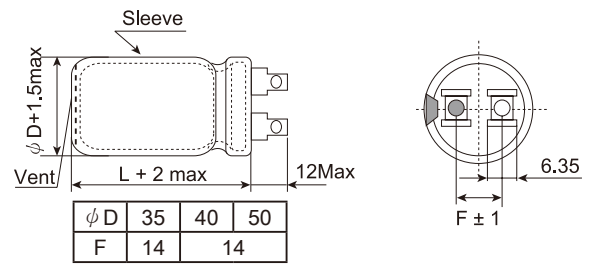

D= ϕ 35 to ϕ 40 mm

PCS

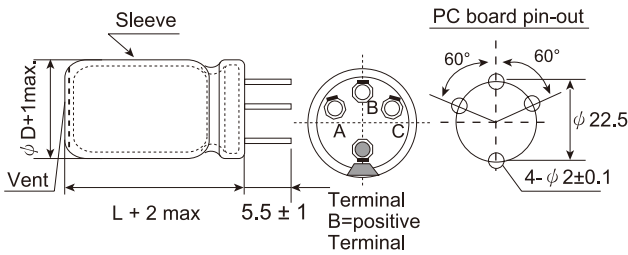

D= ϕ 35 to ϕ 40mm

PCY

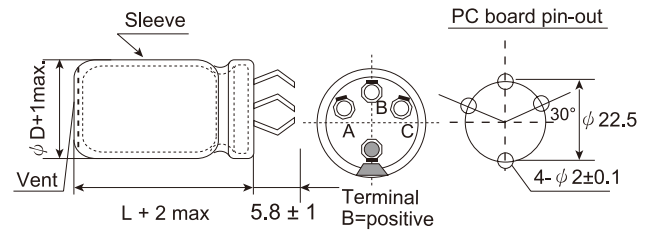

D= ϕ 35 to ϕ 40 mm

PCU

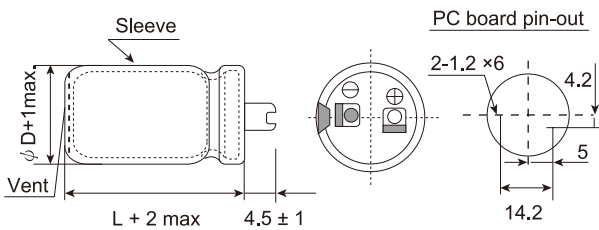

D= ϕ 22 to ϕ 30mm

PCB

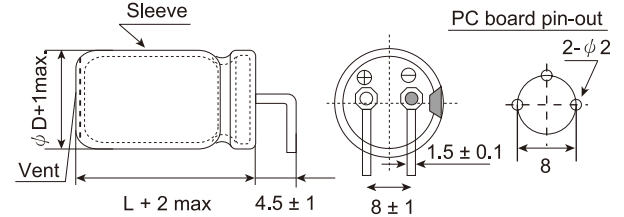

D= ϕ 40 to ϕ 50 mm

U

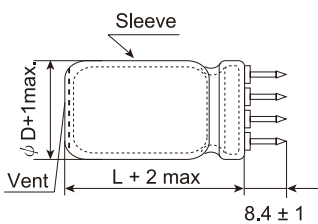

D= ϕ 35 to ϕ 100mm

W

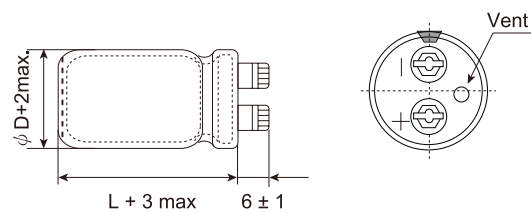

CAUTION :

- Use the blank terminals for mechanical support only.
- The blank terminals must not be connected any copper on PC board.
- Be sure to electrically isolate from negative the positive terminals.

Taping Package

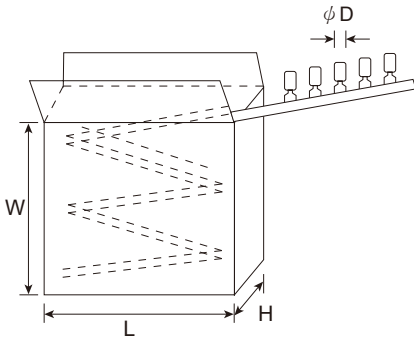

Item	Taping Packing						Tape and Reel
	W±5 (mm)	L±5 (mm)	H±5 (mm)	Qty. (pcs)	G.W. kg/box	Box /Carton	Qty. (pcs)
φ D(mm)							
4	235	327	54	2,500	0.89	10	1800
5	235	327	54	2,000	0.99	10	1200
6.3	235	327	54	1,500	1.12	10	1000
8	265	327	51	1,000	1.48	10	800
10 (L≤16)	235	330	57	600	1.29	10	600
10 (L≤20)	235	330	57	600	1.48	10	600
12.5 (L≤21)	280	315	65	400	1.73	6	400
13 (L≤21)	280	315	65	400	1.95	6	400
13 (L≤25)	280	315	65	400	2.35	6	
φ D≤10	290	310	72	400	2.65	6	
16 (L≤26)	290	310	72	250	1.85	6	
16 (L≤32)	290	310	72	250	2.25	6	
16 (L≤36)	290	310	72	250	2.45	6	

Taping and Reel

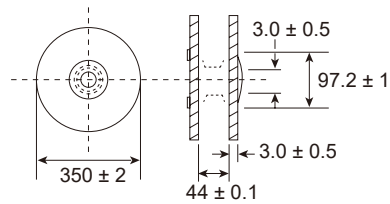

Chip Packing

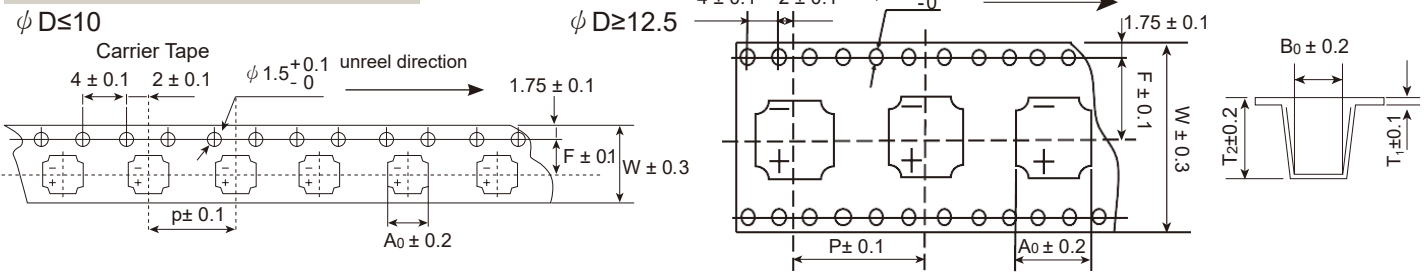

Size	Item					
	W	P	F	A ₀	B ₀	T ₂
φ 4 x 5.4 L	12.0	8.0	5.5	5.0	5.0	5.8
φ 5 x 5.4 L	12.0	12.0	5.5	6.0	6.0	5.8
φ 6.3 x 5.4 L	16.0	12.0	7.5	7.0	7.0	5.8
φ 6.3 x 7.7 L	16.0	12.0	7.5	7.0	7.0	8.0
φ 8 x 10 L	24.0	16.0	11.5	8.7	8.7	11
φ 10 x 10 L	24.0	16.0	11.5	10.7	10.7	11
φ 12.5 x 13.5 L	32.0	24.0	14.2	13.4/13.7(G)	13.4/13.7(G)	15
φ 16 x 16.5 L	44.0	28.0	20.2	17.5	17.5	17.5

"(G)" "Anti-vibration Structure".

Chip Reel

Package Quantity

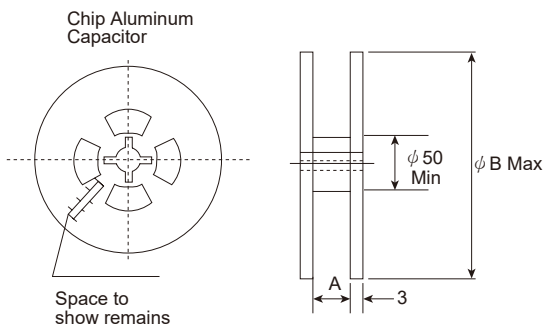

Size	Q'ty / Reel
φ 4 x 5.4 L	2000pcs
φ 5 x 5.4 L	1000pcs
φ 6.3 x 5.4 L	1000pcs
φ 6.3 x 7.7 L	1000pcs
φ 8 x 10 L	500pcs
φ 10 x 10 L	500pcs
φ 12.5 x 13.5 L	250pcs
φ 16 x 16.5 L	200pcs

Size	φ 4~5	φ 6.3	φ 8	φ 10	φ 12.5	φ 16
A	14	18	26	26	34	46
B	382	382	382	382	382	382

Package Information

Unit:(mm)

Type of Product	Dim. (DxL)	Bags / Inner Box	Layer Quantity	Quantity (pcs/bag)	Total Quantity (pcs/Carton)	Wt (kg/bag)	Size of Inner Box (mm)	Size of Out Box (mm)
Radial (Standard Bulk)	4x5	20	2	1000	40,000	0.19	267 X 260 X 135	546 X 279 X 160
	4x7	20	2	1000	40,000	0.23		
	5x5	15	2	1000	30,000	0.25		
	5x7	10	2	1000	20,000	0.32		
	5x11	10	2	1000	20,000	0.43		
	6.3x5	10	2	1000	20,000	0.37		
	6.3x7	10	2	1000	20,000	0.45		
	6.3x11	8	2	1000	16,000	0.60		
	8x5	10	2	500	10,000	0.23		
	8x9	10	2	500	10,000	0.42		
	8x12	10	2	500	10,000	0.49		
	8x14	8	2	500	8,000	0.63		
	8x16	6	2	500	6,000	0.69		
	8x20	6	2	500	6,000	0.71		
	10x13	11	2	200	4,400	0.38		
10x16	9	2	200	3,600	0.45			
Radial (Special Bulk)	4x5	15	2	1000	30,000	0.13	365 X 245 X 230	365 X 245 X 230
	4x7	15	2	1000	30,000	0.18		
	5x5	10	2	1000	20,000	0.19		
	5x7	10	2	1000	20,000	0.27		
	5x11	10	2	1000	20,000	0.40		
	6.3x5	10	2	1000	20,000	0.31		
	6.3x7	10	2	1000	20,000	0.40		
	6.3x11	10	2	1000	20,000	0.55		
	8x5	20	2	250	10,000	0.11		
	8x7	20	2	250	10,000	0.15		
	8x9	20	2	250	10,000	0.20		
	8x12	20	2	250	10,000	0.23		
	8x14	20	2	250	10,000	0.28		
	8x16	20	2	250	10,000	0.33		
	8x20	18	2	250	9,000	0.39		
8x25	14	2	250	7,000	0.48			
Cutting	4x5	30	2	1000	60,000	0.13	267 X 260 X 135	546 X 279 X 160
	4x7	30	2	1000	60,000	0.18		
	5x5	20	2	1000	40,000	0.19		
	5x7	20	2	1000	40,000	0.27		
	5x11	15	2	1000	30,000	0.40		
	6.3x5	15	2	1000	30,000	0.31		
6.3x7	15	2	1000	30,000	0.40			

PACKAGE BOX

Inner Box



Inner Box Size:
(L) X (W) X (H)

Carton

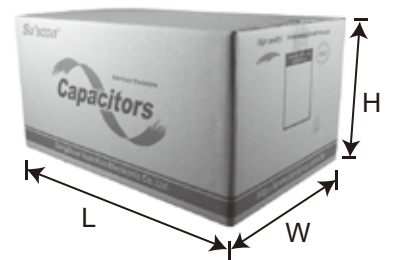

Carton Size:
(L) X (W) X (H)

Type of Product	Dim. (DxL)	Quantity (pcs/Inner Box)	Layer Quantity	Total Quantity (pcs/Carton)	Unit Wt. (kg/pcs)	Gross (kg/Inner Box)	Size of Inner Box (mm)	Size of Out Box (mm)	
Snap-In, LUG	20x50	200	4	800	0.022	4.61	272 X 272 X 146	564 X 282 X 312	
	22x25	300	4	1200	0.013	4.11			
	22x30	300	4	1200	0.016	5.01			
	22x35	200	4	800	0.020	4.21			
	22x40	200	4	800	0.022	4.61			
	22x45	200	4	800	0.023	4.81			
	22x50	200	4	800	0.030	6.21			
	25x25	300	4	1200	0.016	5.05			
	25x30	300	4	1200	0.017	5.35			
	25x35	300	4	1200	0.022	6.85			
	25x40	200	4	800	0.028	5.85			
	25x45	200	4	800	0.032	6.65			
	25x50	200	4	800	0.035	7.25			
	30x25	75	4	300	0.024	1.92			
	30x30	75	4	300	0.027	2.15			
	30x35	75	4	300	0.036	2.82			
	30x40	50	4	200	0.040	2.12			
	30x45	50	4	200	0.045	2.37			
	30x50	50	4	200	0.050	2.62			
	30x55	50	4	200	0.055	2.87			
Snap-In, LUG	35x30	75	4	300	0.036	2.87	204 X 204 X 146	428 X 214 X 312	
	35x35	75	4	300	0.039	3.06			
	35x40	50	4	200	0.046	2.44			
	35x50	50	4	200	0.061	3.19			
	35x120	25	4	100	0.161	16.24			204x204x146
	Screw Terminal	51x100	40	1	40	0.278	11.83	515x337x210	515x337x210
		51x120	40	1	40	0.326	13.75		
		51x170	36	1	36	0.412	15.76	515x337x260	515x337x260
		64x120	24	1	24	0.485	12.35	515x337x210	515x337x210
		64x140	20	1	20	0.558	12.09	515x337x260	515x337x260
64x170		20	1	20	0.775	16.43			
64x195		16	1	16	0.510	9.31	515x337x310	515x337x310	
76x140		12	1	12	0.714	9.50	515x337x260	515x337x260	
76x150		12	1	12	0.603	8.17			
76x170		12	1	12	1.012	13.07			
76x190	9	1	9	1.209	12.03				
Screw Terminal	76x220	9	1	9	1.472	14.39	515x337x310	515x337x310	
	90x170	12	1	12	1.237	15.77	515x337x260	515x337x260	
	90x190	7	1	7	1.635	12.59	515x337x310	515x337x310	



冠坤電子企業股份有限公司

KUAN KUN ELECTRONIC ENTERPRISE CO., LTD.

新北市23511中和區建八路2號5樓之3
5F-3, NO.2, JIAN 8TH RD., ZHONGHE DIST.,
NEW TAIPEI CITY 23511, TAIWAN (R.O.C.)
TEL:886-2-8226-9699 FAX:886-2-8226-9670
E-mail: sales@su-scon.com.tw

冠碩投資股份有限公司

KUAN SHIH INVESTMENTS CO., LTD.

香港九龍觀塘開源道49號 創貿廣場22樓5室
FLAT 5, 22/F APEC PLAZA, 49 HOL YUEN ROAD,
KWUN TONG, KOWLOON, HONG KONG
TEL:852-2385-7603 FAX:852-2385-8725

東莞冠宜電子有限公司

DONG GUAN KUAN YI ELECTRONIC CO., LTD.

廣東省523648東莞市清溪鎮銀河工業區銀瓶路41號
YIN HE INDUSTRIAL ZONE, QING XI TOWN,
DONG GUAN CITY, GUANG DONG 523648, CHINA
TEL:86-769-39019168 FAX:86-769-39019167

Su'scon



東莞冠坤電子有限公司

DONG GUAN KUAN KUN ELECTRONIC CO., LTD.

廣東省523648東莞市清溪鎮銀河工業區銀瓶路41號
YIN HE INDUSTRIAL ZONE, QING XI TOWN,
DONG GUAN CITY, GUANG DONG 523648, CHINA
TEL:86-769-87318000 FAX:86-769-87318008

東莞冠宜電子有限公司蘇州分公司

DONG GUAN KUAN YI ELECTRONIC CO., LTD SUZHOU BRANCH

蘇州工業園區啟月街288號紫金東方商務廣場1商幢2-1008室
ROOM 2-1008, ZIJIN ORIENTAL PLAZA, NO.288, QIYUE STREET,
INDUSTRIAL PARK, SUZHOU
TEL:0512-62857850 FAX:0512-62857856

X-ON Electronics

Largest Supplier of Electrical and Electronic Components

Click to view similar products for [Aluminium Electrolytic Capacitors - SMD category](#):

Click to view products by [Suscon manufacturer](#):

Other Similar products are found below :

[ULV2H4R7MNL1GS](#) [ULV2H1R8MNL1GS](#) [EMZA500ARA221MJA0G](#) [MAL214099813E3](#) [CA025M4R70REB-0405](#)

[UCX1V471MNQ1MS](#) [10SVP120M](#) [DV100M050C055ETR](#) [RVJ-50V101MH10U-R](#) [AEH1012471M016R](#) [MAL213967339E3](#)

[EMK1EM331FB0D00R](#) [EMF1CM221FB0D00R](#) [EMF1CM331FB0D00R](#) [EMF1CM471FB0D00R](#) [EMK1JM101GB0D00R](#)

[EMK1AM102GB0D00R](#) [EMK1HM221GB0D00R](#) [DV221M6R3E055ETR](#) [DV221M025E077ETR](#) [RV331M025F105ETR](#) [RVT1A101M0505](#)

[GVZ1H101M0607](#) [CK1E100M0405](#) [GVM1E331M0607](#) [VT10UF100V167RV0127](#) [VT100UF16V167RV0124](#) [CS100UF35V167RV0155](#)

[CK220UF16V167RV0142](#) [VT10UF16V167RV0128](#) [VT22UF35V167RV0131](#) [CS470UF10V167RV0150](#) [CK100UF16V167RV0138](#)

[CK220UF10V167RV0141](#) [RVT330UF25V167RV0055](#) [VT470UF16V167RV0135](#) [CS100UF10V167RV0144](#) [126RV0017](#)

[VT47UF35V167RV0137](#) [CS220UF35V167RV0148](#) [126RV0010](#) [126RV0009](#) [VT220UF25V167RV160](#) [VT220UF16V167RV0088](#)

[126RV0012](#) [126RV0011](#) [126RV0013](#) [126RV0018](#) [126RV0008](#) [126RV0015](#)