

Mechanical Dimensions: Inches [mm]

Tolerances ± 0.012 [0.3] Unless Otherwise Specified

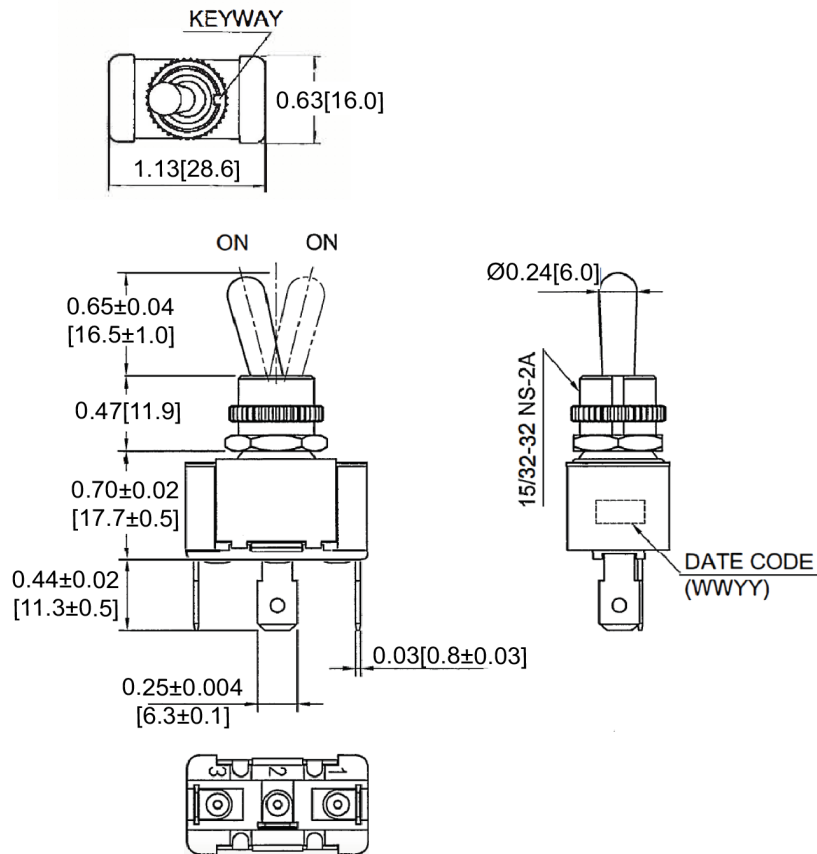

Mounting Hole

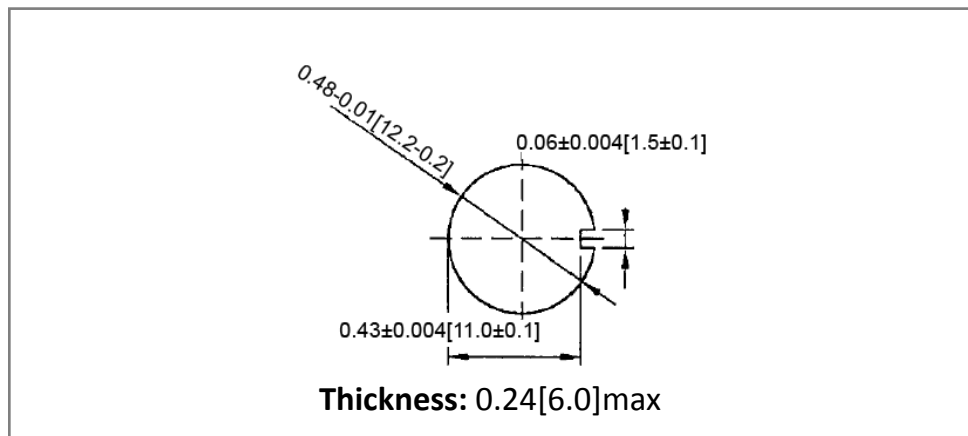

Circuit Diagram

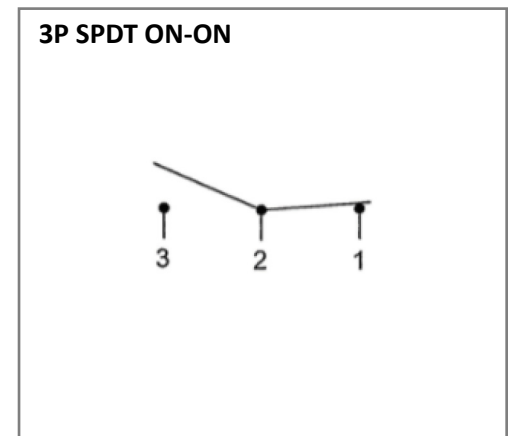

Electrical Specifications

Rating	21A 14V DC
Contact Resistance	50m ohm Max
Insulation Resistance	DC 500V 100M ohm Min
Dielectric Strength	AC 1500V 1 minute
Operation Temperature	-20°C ~ 85°C

Material Specifications

Operation Force	700gf \pm 250gf
	1 Hex Nut Assy
	1 Knurl Nut Assy

Rev	Date of issue	Revision Notes	Designed	Approved
B	03-04-2020	Initial Drawing	RC	OF

X-ON Electronics

Largest Supplier of Electrical and Electronic Components

Click to view similar products for [Toggle Switches](#) category:

Click to view products by [SWITCH COMPONENTS](#) manufacturer:

Other Similar products are found below :

[8928K478](#) [8951K3310](#) [8956K1283](#) [8956K1285](#) [8956K1286](#) [8956K1287](#) [8961K155](#) [8A1-C-222](#) [020017-13](#) [0090-0001](#) [0121-0015](#) [CS115W](#)
[CS120W](#) [CS1223GY](#) [CS215I](#) [CS8275](#) [637H/25](#) [7101SPDV30BE](#) [7103SDV30BE](#) [7105D](#) [7108P3YAV2BE](#) [71YY50282](#) [7209SY9AQE](#)
[7209SYCBE](#) [7300K36](#) [7301SS24484](#) [7303KZQE](#) [7306K36](#) [7503K21](#) [7565K6](#) [7595K6](#) [7660K12](#) [7704K3](#) [8391K108](#) [8811K17](#) [8825K5](#)
[8835K3](#) [8858K44](#) [8E4011](#) [1202W](#) [A201SCWZB04](#) [A207SYCB04](#) [A208J61ZQ0004](#) [A221T1TCQ](#) [A323S1CWZQ](#) [1201W](#) [1203W](#)
[12149A-3V](#) [12156AX408](#) [1221W](#)