

SWITCHCRAFT CABLE CONNECTOR ASSEMBLY INSTRUCTIONS

STEP 1
FEED THE END OF THE CABLE THROUGH THE BOOT AND CABLE CLAMP HOUSING IN THE ORDER AND POSITION SHOWN.

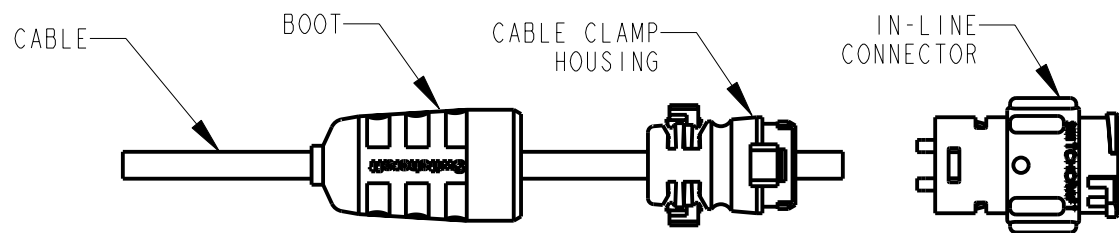

STEP 2
STRIP CABLE AS SHOWN AND BEGIN SOLDERING CONDUCTORS TO PINS. STARTING WITH CONTACT NO. 1 NEXT TO THE "NOTCH" AND FOLLOW WITH THE REMAINING CONDUCTORS CLOCKWISE WITH NO. 6 OR NO. 8 CONDUCTOR IN THE CENTER.

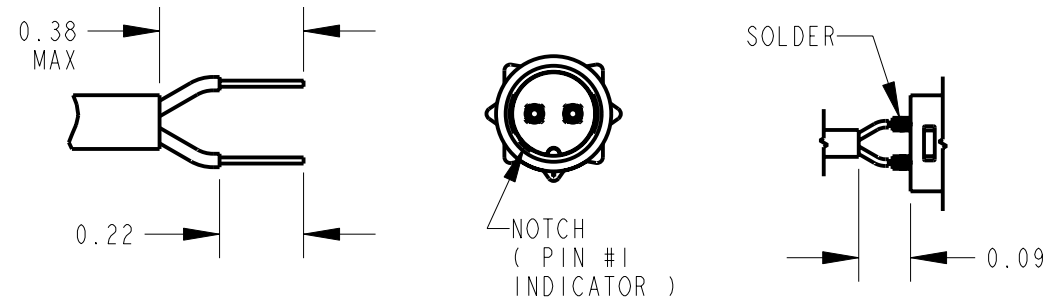

STEP 3
PUSH THE CABLE CLAMP HOUSING FORWARD UNTIL IT LOCKS INTO THE CONNECTOR BODY AND SNAP THE TWO CLAMPS INTO ITS COMPARTMENTS.

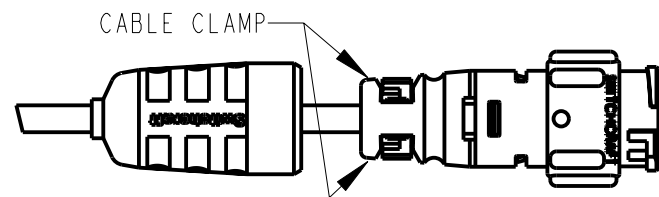

STEP 4
PUSH THE BOOT ALL THE WAY FORWARD TO SEAT TIGHTLY ONTO THE CABLE CLAMP HOUSING.

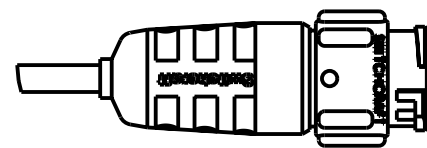

SPECIFICATIONS

MECHANICAL:
SHOCK: MIL-STD 202 METHOD 213B, COND. K.
VIBRATION: MIL-STD 202 METHOD 201
LIFE: 300 INSERTION/WITHDRAWAL CYCLES (MINIMUM)

ELECTRICAL
DIELECTRIC WITHSTANDING VOLTAGE: 1,000 VAC
INSULATION RESISTANCE: 100 MEGOHMS (MIN) AT 77°F
CONTACT RESISTANCE: 5.0 MILLOHMS MAX.
CURRENT RATING: 7.5 AMPS (#20 CONTACT)
6.5 AMPS (7 & 8 PIN #20 CONTACT)
13.0 AMPS (#16 CONTACT)

ENVIRONMENTAL
TEMPERATURE LIMITS: -40°C TO +65°C (NON-OPERATING)
MOISTURE RESISTANCE: MIL-STD 202 METHOD 106F
INSULATION RESISTANCE: MIL-STD 202 METHOD 302, COND. B
THERMAL SHOCK: MIL-STD 202 METHOD 107G
SALT SPRAY: MIL-STD 202 METHOD 101D, COND. B
WATER TIGHTNESS TEST: U.S. COAST GUARD CFR 46 PART 110.20

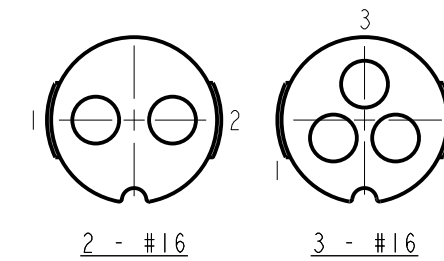
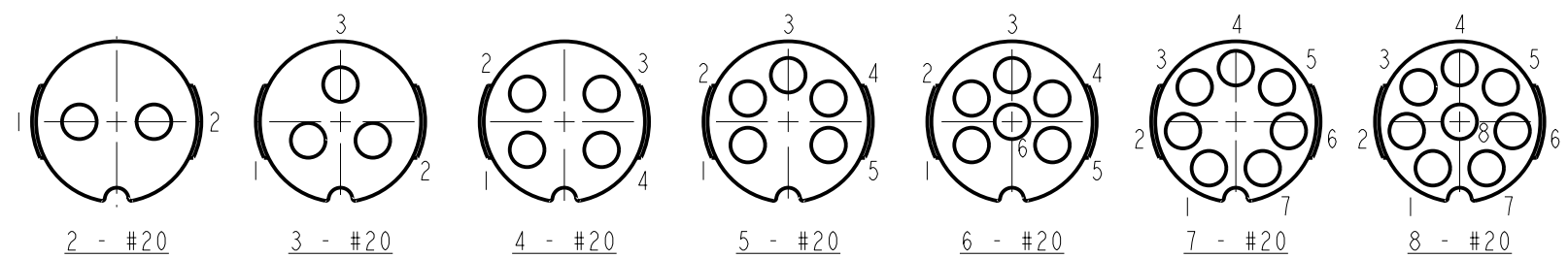

CONTACT ARRANGEMENTS

SHOWN ARE REAR VIEWS OF MALE INLINE CONNECTORS

MATERIALS:
IN-LINE CONNECTOR SHELL, CONTACT LOCKING DISK, AND CABLE CLAMP ASSEMBLY: THERMOPLASTIC POLYMER GLASS FIBER, FLAME RETARDANT

REAR BOOT AND CONNECTOR SHELL INTERIOR: THERMOPLASTIC RUBBER

CONTACTS: COPPER BASE ALLOY GOLD-PLATED OVER NICKEL UNDERPLATE

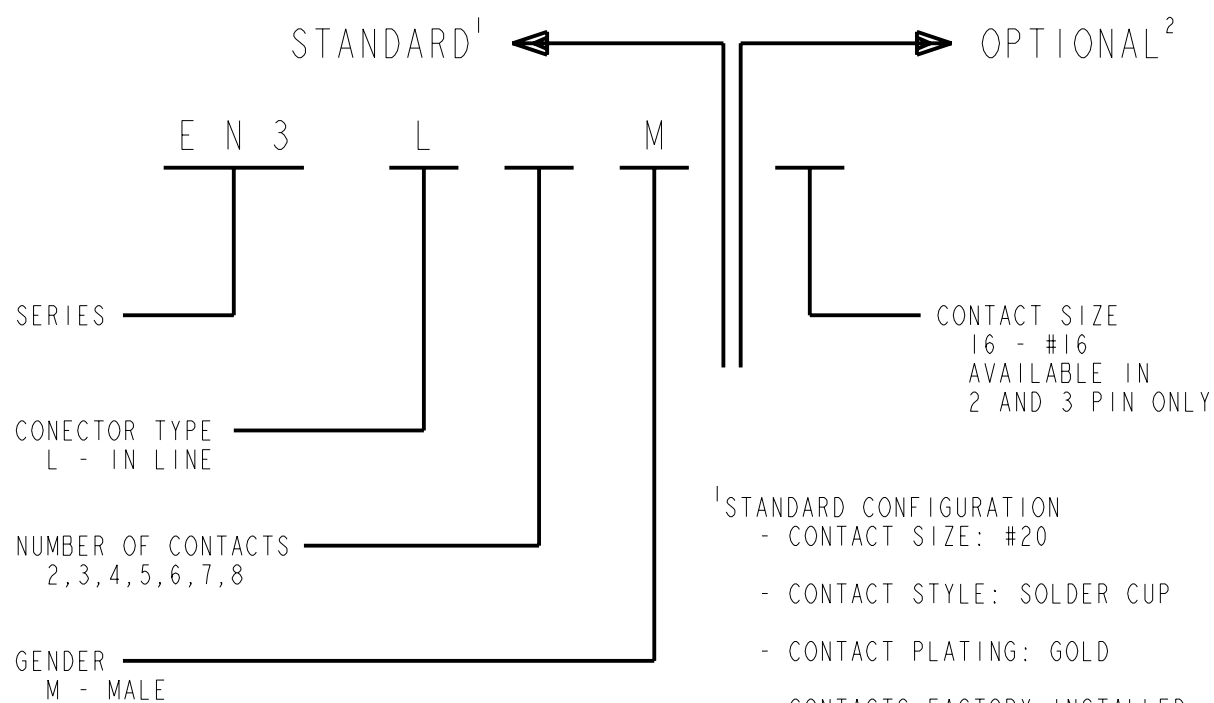

¹STANDARD CONFIGURATION
- CONTACT SIZE: #20
- CONTACT STYLE: SOLDER CUP
- CONTACT PLATING: GOLD
- CONTACTS FACTORY INSTALLED
- PACKAGED IN BULK

²OPTIONAL CONFIGURATION
- LEAVE BLANK FOR STANDARD CONFIGURATION

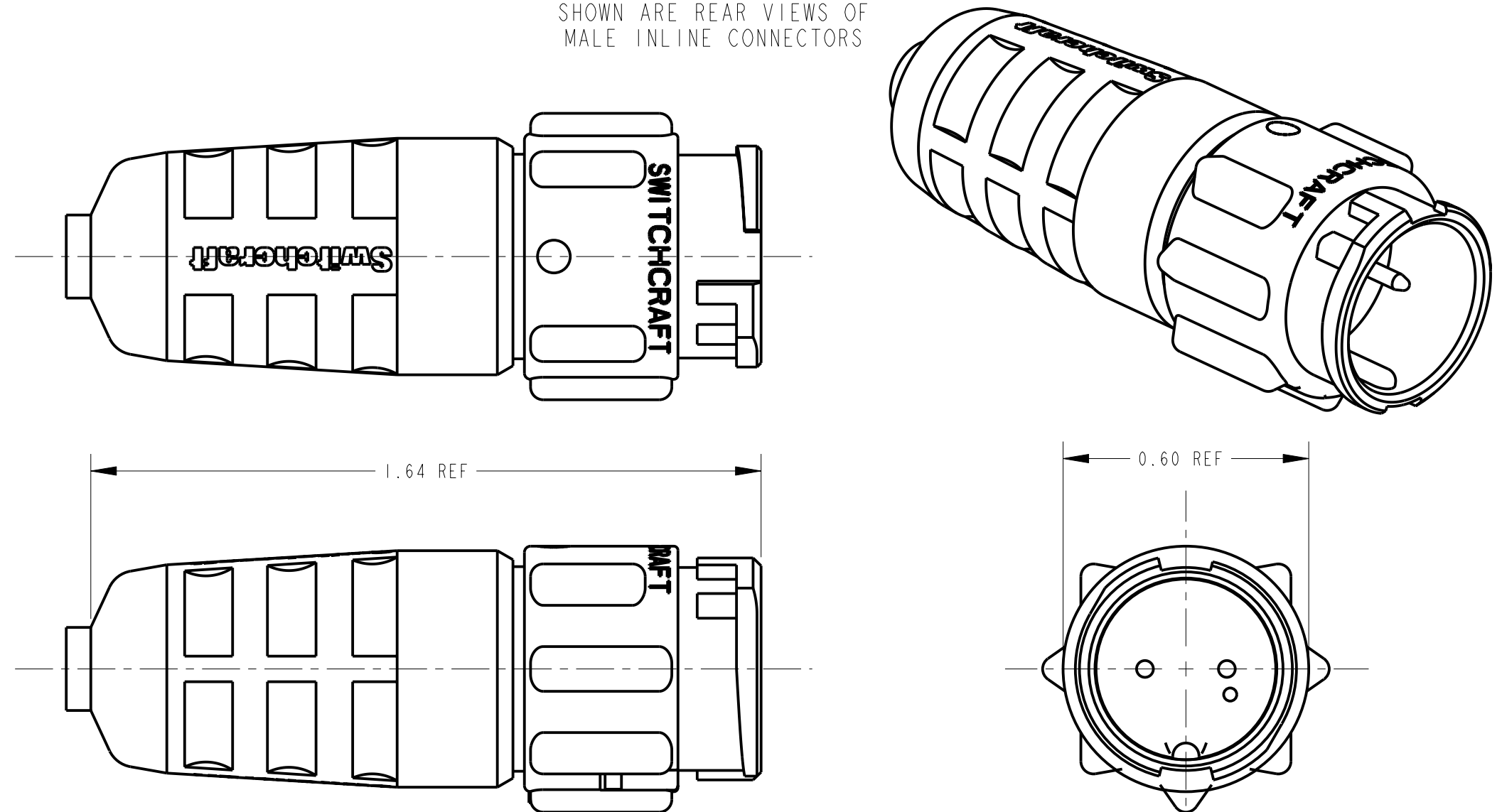

CUSTOMER DRAWING

★ STAR SYMBOL DENOTES CRITICAL DIMENSION				THIS DRAWING DESCRIBES A DESIGN CONSIDERED PROPRIETARY IN NATURE, DEVELOPED AND MANUFACTURED BY SWITCHCRAFT INC. AND IS RELEASED ON A CONFIDENTIAL BASIS FOR IDENTIFICATION PURPOSES ONLY.				
UNLESS OTHERWISE SPECIFIED				SIZE	WIDTH	MULT	LBS/M	TEMPER
1. ALL DIMENSIONS IN INCHES - TWO PLACE DECIMALS ±0.01 - THREE PLACE DECIMALS ±0.005 - ANGLES ±1° - ALL DIA. CONCENTRIC WITHIN 0.005 T.I.R.				FINISH		MATERIAL SPEC No.		
2. FEATURES ON THE SAME CENTERLINE MUST BE ALIGNED WITHIN ±0.002				FIRST USED ON		SCALE 2:1		
3. REMOVE ALL BURRS				DATE DRAWN	BY	CHKD	APVD	SHEET OF EN3L_M
DO NOT SCALE DRAWING				22-May-95	SG	5-22-95	5-25-95	
REVISIONS				MALE CONNECTOR				REV B

X-ON Electronics

Largest Supplier of Electrical and Electronic Components

Click to view similar products for [Standard Circular Connector](#) category:

Click to view products by [SWITCHCRAFT](#) manufacturer:

Other Similar products are found below :

[C015](#) [10F006](#) [001](#) [1](#) [5M2530B10P](#) [600247N007](#) [600259N006](#) [600273N007](#) [600432N009](#) [6280-2PG-519](#) [6280-3PG-311](#) [6280-3SG-311](#)
[6280-7SG-3DC](#) [6280-7SG-522](#) [6282-5PG-311](#) [6282-6PG-519](#) [6282-8SG-311](#) [6283-11](#) [6283-15](#) [6290](#) [6293](#) [6382-2PG-311](#) [6382-2PG-3DC](#)
[6382-2SG-321](#) [6382-2SG-3DC](#) [6382-4SG-516](#) [67-03E20-37P](#) [681-PMG](#) [CXS3102A14S2P](#) [CXS3102A181S](#) [CXS3106A14S6S](#) [MB12P-1](#)
[MB12R-6](#) [7251-2PG-300](#) [7251-2SG-300](#) [7251-4PG-300](#) [7251-4SG-300](#) [7251-5PG-300](#) [7251-5SG-300](#) [7251-6SG-300](#) [7251-7PG-300](#) [7251-](#)
[8PG-300](#) [7271-6SG-300](#) [7282-3PG-300-CH3](#) [73000005663](#) [75-190011-03P](#) [75-190216-08S](#) [75-190218-10P](#) [75-214636-52P](#) [75-474118-10P](#)
[75-474211-03P](#) [75-474218-19S](#) [75-474618-01S](#)