

MFG. ENG. APPROVED BY: DATE: QA APPROVED BY: DATE:

ASS'Y P/N	CONTACT QTY.	CABLE O.D. RANGE
W18980-5SG-P-518	5	0.18 - 0.20 [4.6 - 5.1]
W18980-5SG-P-521	5	0.21 - 0.22 [5.3 - 5.6]
W18980-5SG-P-522	5	0.22 - 0.23 [5.6 - 5.8]
W18980-6SG-P-518	6	0.18 - 0.20 [4.6 - 5.1]
W18980-6SG-P-521	6	0.21 - 0.22 [5.3 - 5.6]
W18980-6SG-P-522	6	0.22 - 0.23 [5.6 - 5.8]
W18980-7SG-P-518	7	0.18 - 0.20 [4.6 - 5.1]
W18980-7SG-P-521	7	0.21 - 0.22 [5.3 - 5.6]
W18980-7SG-P-522	7	0.22 - 0.23 [5.6 - 5.8]
W18980-XSG-P-5XX		

NOTES:

1. ALL PARTS ARE BULK PACKED.
2. REFER TO DRAWING HPMCSTD FOR CONTACT PATTERNS.
3. ALL DIMENSIONS ARE REFERENCE ONLY IN INCHES [mm], WITHIN ±0.015 UNLESS OTHERWISE NOTED.

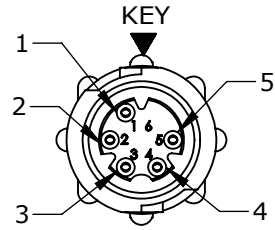

FACE VIEW
W18980-5SG-P-5XX
5 POSITION

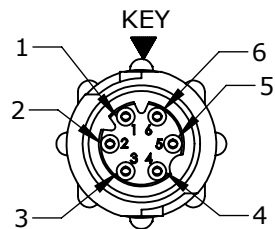

FACE VIEW
W18980-6SG-P-5XX
6 POSITION

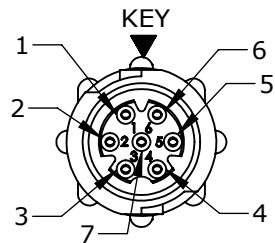

FACE VIEW
W18980-7SG-P-5XX
7 POSITION

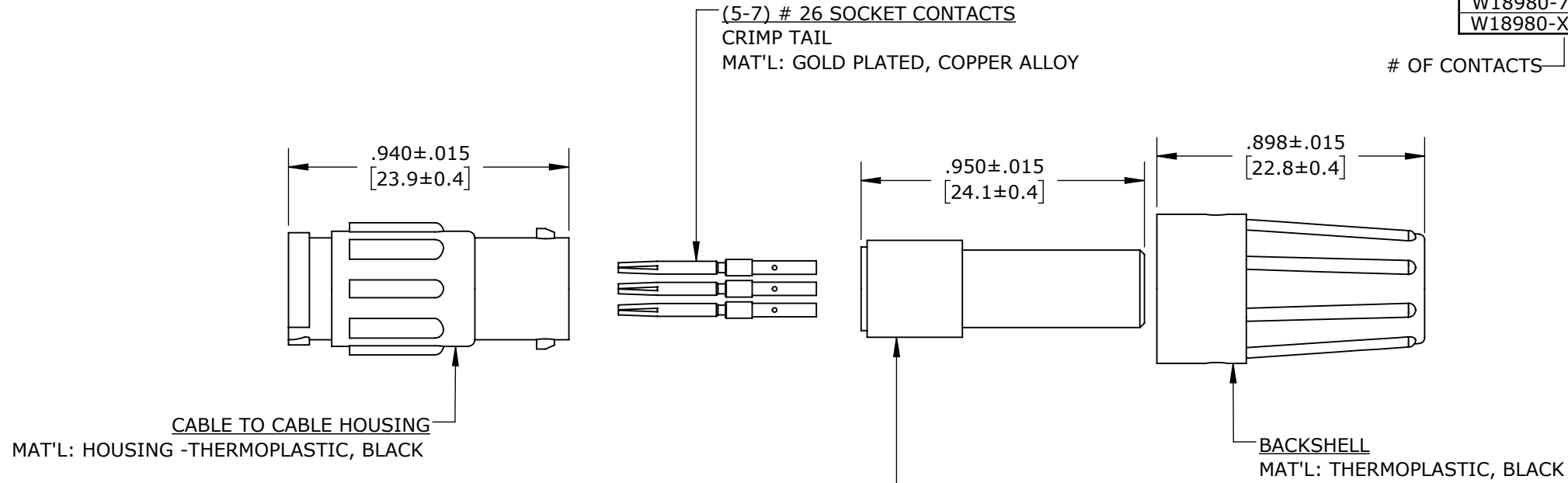

GROMMET SIZE = CABLE O.D. RANGE:
 518 = 0.18 - 0.20 [4.6 - 5.1]
 521 = 0.21 - 0.22 [5.3 - 5.6]
 522 = 0.22 - 0.23 [5.6 - 5.8]

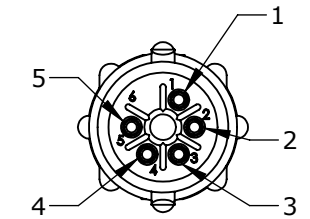

WIRING VIEW
W18980-5SG-P-5XX

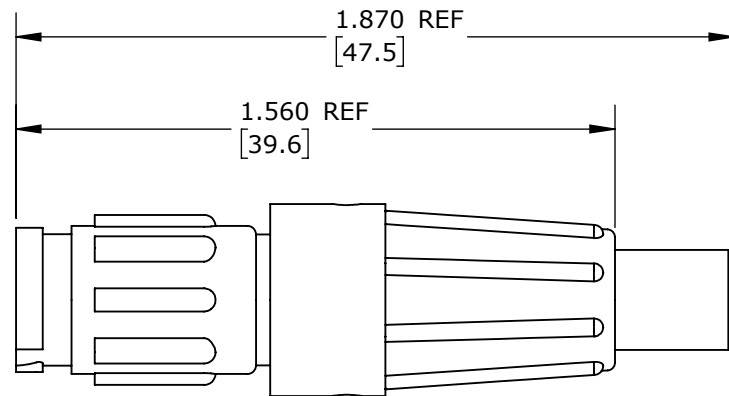

ASSEMBLED VIEW
FOR CUSTOMER REF. ONLY

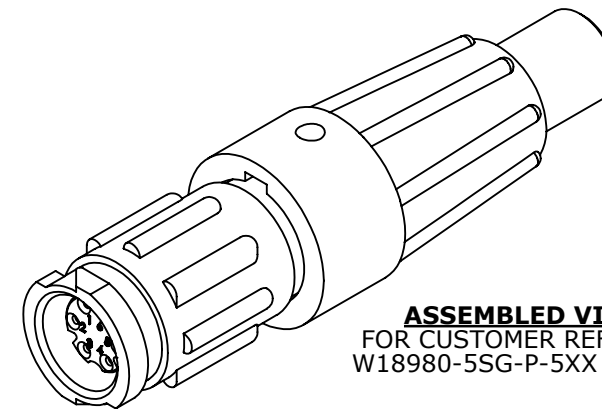

ASSEMBLED VIEW
FOR CUSTOMER REF. ONLY
W18980-5SG-P-5XX SHOWN

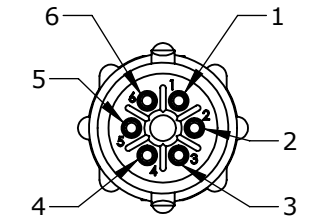

WIRING VIEW
W18980-6SG-P-5XX

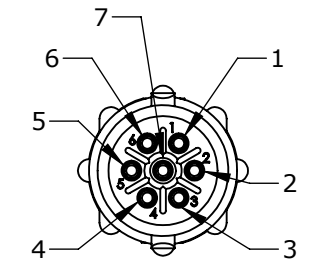

WIRING VIEW
W18980-7SG-P-5XX

CUSTOMER PRINT

PART NUMBER: W18980-XSG-P-5XX

PRELIMINARY

DIMENSIONS IS BRACKETS [] ARE METRIC

CUSTOMER APPROVAL

THIS DOCUMENT CONTAINS CONFIDENTIAL INFORMATION PROPRIETARY TO CONXALL CORPORATION. ANY REPRODUCTION, DISCLOSURE, OR USE OF THIS DOCUMENT /INFORMATION IS EXPRESSLY PROHIBITED UNLESS AUTHORIZED IN WRITING BY CONXALL CORPORATION.

APPROVED BY: _____
DATE: _____

RoHS COMPLIANT

0A	JGK	8/29/19	DRAWING CREATED FOR PDR #18004.	
REV.	INIT.	DATE	DESCRIPTION	
	JGK	8/29/19	ALL INFORMATION ILLUSTRATED IS THE PROPERTY OF "CONXALL CORPORATION". UNAUTHORIZED DUPLICATION OR DISTRIBUTION OF THIS DOCUMENT IS PROHIBITED. ORIG. DRAWN BY: JGK DATE: 8/29/19 CHECKED BY: _____ APPROVED BY: _____ TITLE: CABLE TO CABLE CONN. ASS'Y (5-7) #26 SOCKET CONTACTS, CRIMP INSTA-CLICK, MICRO-CON-X STANDARD PRODUCT CUSTOMER: _____ PART NUMBER: W18980-XSG-P-5XX	
ALL UNITS ARE IN FEET, INCHES, FRACTION OF INCHES AND DECIMALS. UNLESS OTHERWISE SPECIFIED TOLERANCES: 3 PLACE DECIMALS ±.005 ANGLES ±1° FRACTIONS ±1/16 - CRITICAL CHARACTERISTIC FLAG PER SPEC. XXXX			SCALE: NTS SIZE: B SHEET: 1 OF 1	601 E. WILDWOOD VILLA PARK, IL 60181
FILE:	W18980-XSG-P-5XX	DIRECTORY:	SLW	REV: 0A

X-ON Electronics

Largest Supplier of Electrical and Electronic Components

Click to view similar products for [Standard Circular Connector](#) category:

Click to view products by [Switchcraft](#) manufacturer:

Other Similar products are found below :

[5M2530B10P](#) [600259N006](#) [600273N007](#) [6134-336-13149](#) [6134-337-11149](#) [6134-337-2390](#) [6134-341-17149](#) [6280-4SG-516](#) [6280-7SG-3DC](#)
[6290](#) [6291A](#) [66200A-10](#) [680-SMG](#) [681-PMG](#) [CXS3102A14S2P](#) [CXS3102A181S](#) [7271-6SG-300](#) [7282-3PG-300-CH3](#) [75-474014-05S](#) [75-](#)
[474618-01S](#) [75-474618-04P](#) [75-474618-04S](#) [799539-000](#) [MI8-SE](#) [805-005-07NF11-19PC](#) [805-005-07NF15-7PA](#) [8280-4PG-516](#) [8280-7PG-](#)
[519](#) [8282-5PG-519](#) [836783-1](#) [MP-4102-25P-C](#) [862256-1](#) [864019-2](#) [866857-1](#) [867865-1](#) [PT01SP-14-18P](#) [PT08P-14-5S](#) [120-1833-000](#)
[QCM019PC2DC012B](#) [1-2069279-1](#) [121583-0217](#) [121667-0020](#) [129591AU](#) [1000B BULK](#) [RD10A16-19-P6CS051/1](#) [RD10A20-31-](#)
[P8CS051/1](#) [RD16A14-12-S6CS051/2](#) [1301240290](#) [1301240347](#) [1301860202](#) [1301240268](#)