

CUSTOMER PRINT

PART NUMBER: W3B82-8PG-3XX

- NOTES:
 1. PARTS TO BE BULK PACKED.
 2. SOLDER CONTACTS ARE PRESSED INTO CONNECTOR.
 SIZE 12 CONTACTS AND SIZE 26 (POSITIONS 3, 7 & 8) FACE TOP KEY (UP).
 SIZE 26 CONTACTS (POSITIONS 4-6) FACE DOWN.
 3. ALL DIMENSIONS ARE FOR REFERENCE ONLY EXCEPT WHERE NOTED WITH TOLERANCE.

ASSY P/N	COUPLING RING P/N	CABLE O.D.
W3B82-8PG-335	4282V4	.350-.370 IN. [8.9-9.4mm]
W3B82-8PG-335W	4482V4	.350-.370 IN. [8.9-9.4mm]

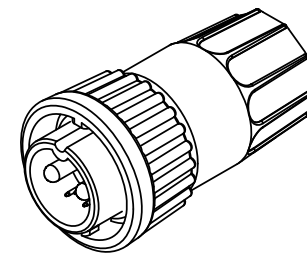

STD COUPLING RING
 P/N: W3B82-8PG-3XX

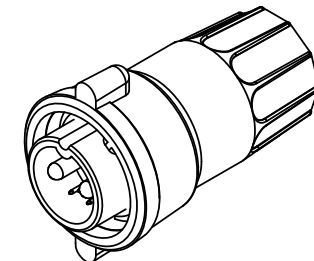

WINGED COUPLING RING
 P/N: W3B82-8PG-3XXW

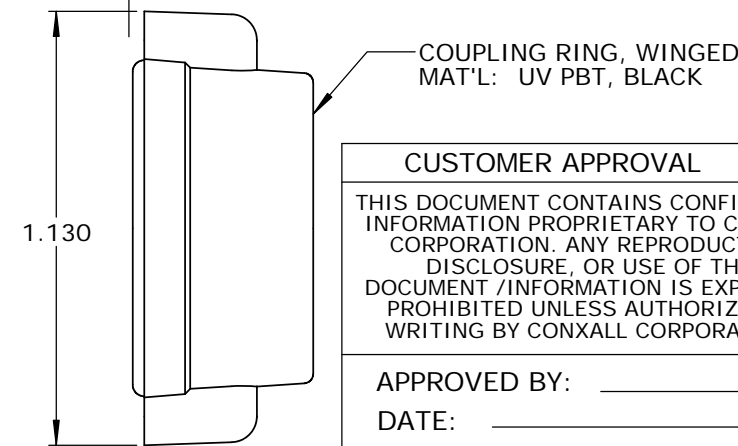
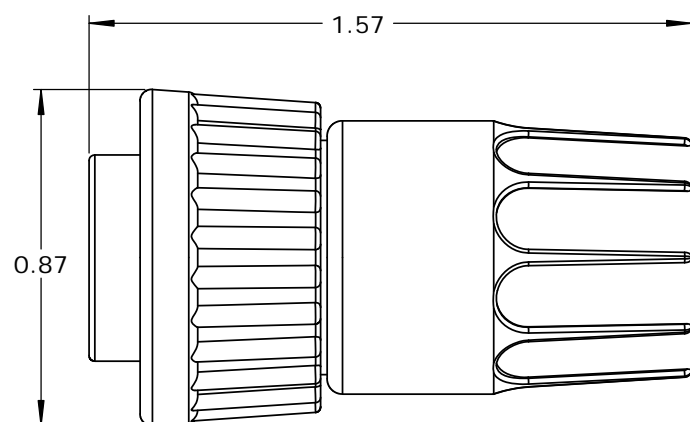
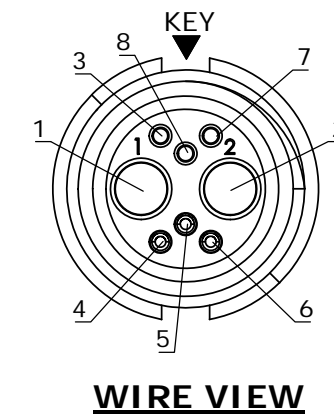
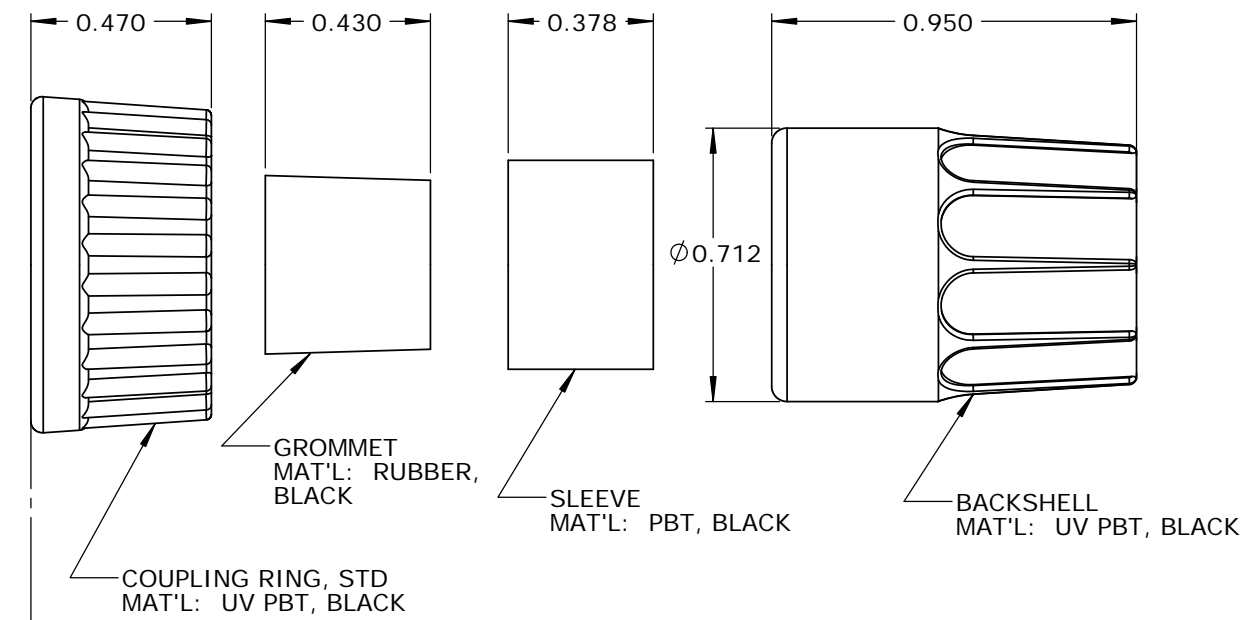
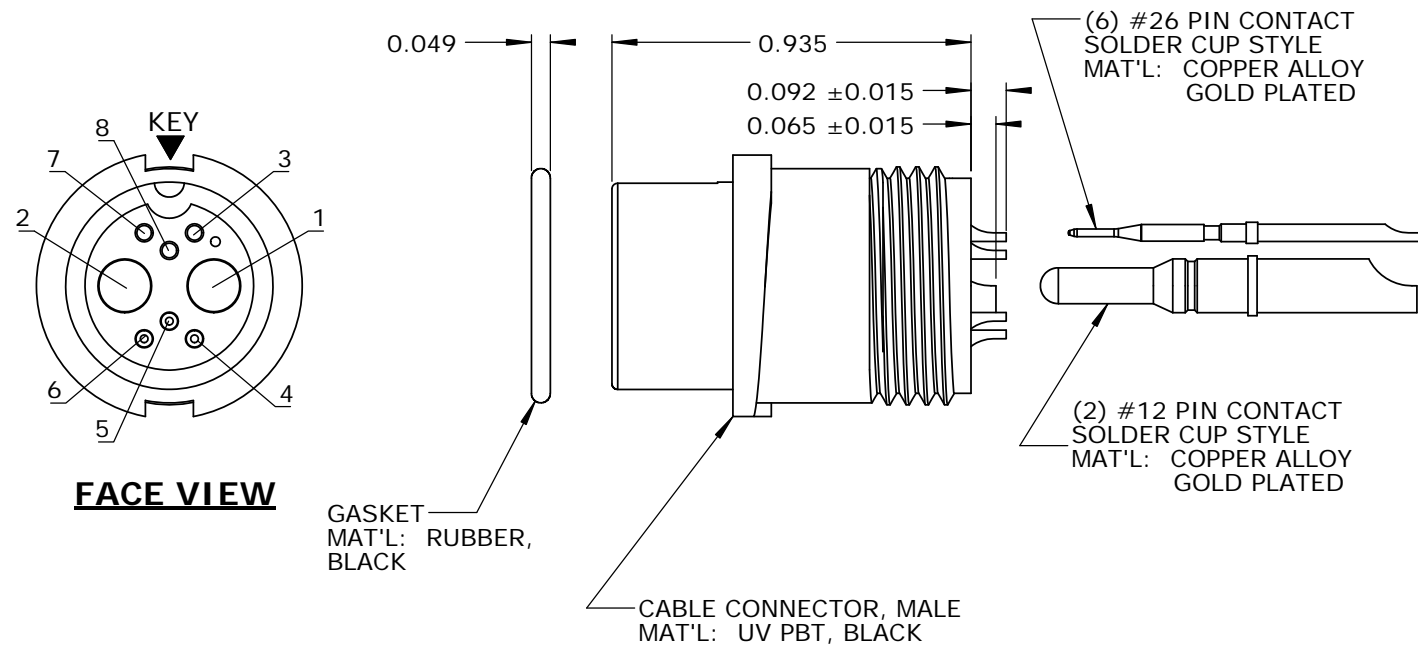

CUSTOMER APPROVAL

THIS DOCUMENT CONTAINS CONFIDENTIAL INFORMATION PROPRIETARY TO CONXALL CORPORATION. ANY REPRODUCTION, DISCLOSURE, OR USE OF THIS DOCUMENT /INFORMATION IS EXPRESSLY PROHIBITED UNLESS AUTHORIZED IN WRITING BY CONXALL CORPORATION.

APPROVED BY: _____
 DATE: _____

RoHS COMPLIANT

A	AB	05-09-19	RELEASE PER DOR 14-6281TC
REV.	INIT.	DATE	DESCRIPTION
ALL INFORMATION ILLUSTRATED IS THE PROPERTY OF "CONXALL CORPORATION". UNAUTHORIZED DUPLICATION OR DISTRIBUTION OF THIS DOCUMENT IS PROHIBITED.		ORIG. DRAWN BY: AB	DATE: 07-21-14
ALL UNITS ARE IN FEET, INCHES, FRACTION OF INCHES AND DECIMALS.		CHECKED BY:	<p>601 E. WILDWOOD VILLA PARK, IL 60181</p>
APPROVED BY:		TITLE: CABLE END CONNECTOR KIT (2)#12 + (6)#26 PIN CONTACTS, SOLDER CUP MULTI-CON-X, WEATHER RESISTANT STANDARD PRODUCT	
SCALE: NTS	SIZE: B	SHEET: 1 OF 1	CUSTOMER: STANDARD PRODUCT
FILE: SAME AS P/N	DIRECTORY: SLW	PART NUMBER: W3B82-8PG-3XX(W)	REV: A

X-ON Electronics

Largest Supplier of Electrical and Electronic Components

Click to view similar products for [Standard Circular Connector](#) category:

Click to view products by [Switchcraft](#) manufacturer:

Other Similar products are found below :

[5M2530B10P](#) [600259N006](#) [600273N007](#) [6134-336-13149](#) [6134-337-11149](#) [6134-337-2390](#) [6134-341-17149](#) [6280-4SG-516](#) [6280-7SG-3DC](#)
[6290](#) [6291A](#) [66200A-10](#) [680-SMG](#) [681-PMG](#) [CXS3102A14S2P](#) [CXS3102A181S](#) [7251-5SG-300](#) [7271-6SG-300](#) [7282-3PG-300-CH3](#) [75-](#)
[474618-01S](#) [75-474618-04P](#) [75-474618-04S](#) [799539-000](#) [MI8-SE](#) [805-005-07NF11-19PC](#) [805-005-07NF15-7PA](#) [8280-4PG-516](#) [8280-7PG-](#)
[519](#) [8282-5PG-519](#) [836783-1](#) [MP-4102-25P-C](#) [862256-1](#) [864019-2](#) [866857-1](#) [867865-1](#) [PT01SP-14-18P](#) [PT08P-14-5S](#) [PTSF06SE-14-12S](#)
[120-1833-000](#) [QCM019PC2DC012B](#) [1-2069279-1](#) [121583-0217](#) [121667-0020](#) [129591AU](#) [1000B BULK](#) [RD10A16-19-P6CS051/1](#)
[RD10A20-31-P8CS051/1](#) [RD16A14-12-S6CS051/2](#) [1301240290](#) [1301240347](#) [1301860202](#)