

NOTES:

1. ALL PARTS TO BE BULK PACKED.
2. CONTACTS SUPPLIED UNASSEMBLED
3. ALL DIMENSIONS ARE REFERENCE EXCEPT THOSE WITH A TOLERANCE
4. DIMENSIONS IN BRACKETS [] ARE IN MILLIMETERS

ASS'Y P/N	GROMMET SIZE
W6280-XSG-P-513	.148 GROMMET I.D. FOR CABLE O.D. 0.13 - 0.15 [3.3 - 3.8]
W6280-XSG-P-516	.176 GROMMET I.D. FOR CABLE O.D. 0.16 - 0.18 [4.1 - 4.6]
W6280-XSG-P-519	.206 GROMMET I.D. FOR CABLE O.D. 0.19 - 0.21 [4.8 - 5.3]
W6280-XSG-P-522	.245 GROMMET I.D. FOR CABLE O.D. 0.22 - 0.25 [5.6 - 6.3]
W6280-XSG-P-526	.265 GROMMET I.D. FOR CABLE O.D. 0.25 - 0.27 [6.3 - 6.8]
W6280-XSG-P-528	.280 GROMMET I.D. FOR CABLE O.D. 0.26 - 0.28 [6.6 - 7.1]

ASSEMBLY P/N	CONTACTS
W6280-2SG-P-5XX	2 #20
W6280-3SG-P-5XX	3 #20
W6280-4SG-P-5XX	4 #20
W6280-5SG-P-5XX	5 #20
W6280-6SG-P-5XX	6 #20
W6280-7SG-P-5XX	7 #20
W6280-8SG-P-5XX	8 #20
W6280-XSG-P-5XX	

CUSTOMER APPROVAL

THIS DOCUMENT CONTAINS CONFIDENTIAL INFORMATION PROPRIETARY TO CONXALL CORPORATION. ANY REPRODUCTION, DISCLOSURE, OR USE OF THIS DOCUMENT /INFORMATION IS EXPRESSLY PROHIBITED UNLESS AUTHORIZED IN WRITING BY CONXALL CORPORATION.

APPROVED BY: _____
DATE: _____

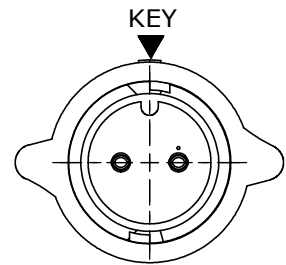

MATING FACE
W6280-2SG-P-5XX SHOWN

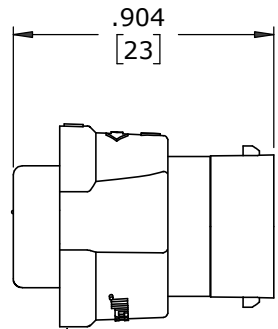
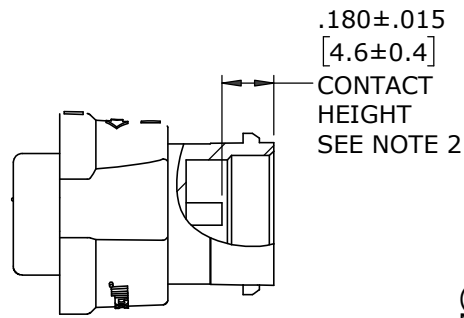

CABLE-END HOUSING
MAT'L: UV PBT, BLACK
COUPLING RING
MAT'L: UV PBT, BLACK
O-RING
MAT'L: SILICONE, RED
SPRING
MAT'L: STAINLESS STEEL

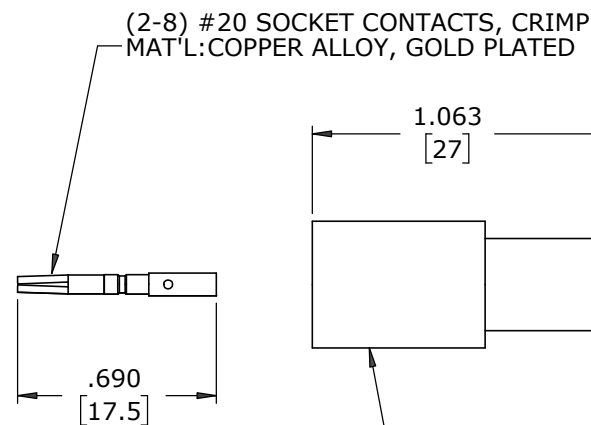

(2-8) #20 SOCKET CONTACTS, CRIMP
MAT'L: COPPER ALLOY, GOLD PLATED

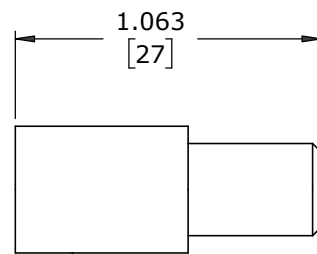

GROMMET
MAT'L: SANTOPRENE, BLACK

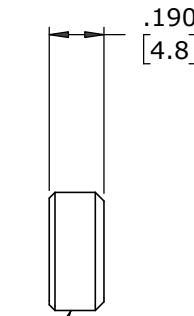

CABLE GRIP
MAT'L: POLYPROPYLENE, BLACK

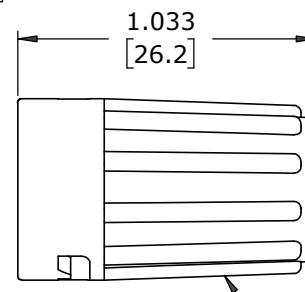

BACKSHELL
MAT'L: UV PBT, BLACK

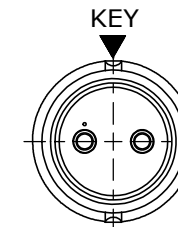

WIRING END
W6280-2SG-P-5XX SHOWN
WITHOUT HARDWARE

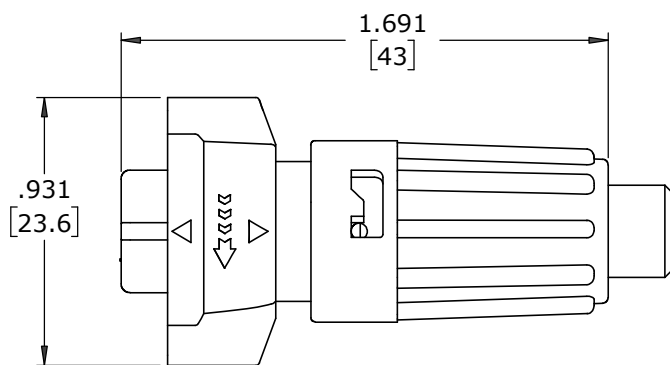

SHOWN ASSEMBLED
FOR CUSTOMER REFERENCE ONLY

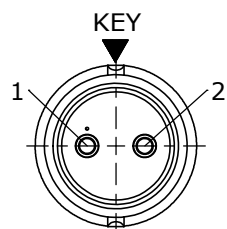

WIRING END
W6280-2SG-P-5XX

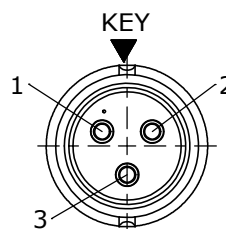

WIRING END
W6280-3SG-P-5XX

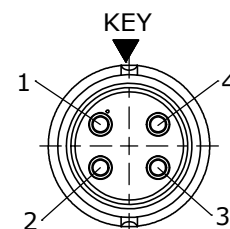

WIRING END
W6280-4SG-P-5XX

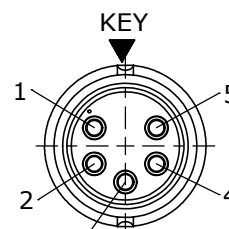

WIRING END
W6280-5SG-P-5XX

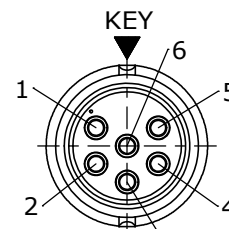

WIRING END
W6280-6SG-P-5XX

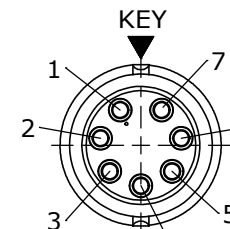

WIRING END
W6280-7SG-P-5XX

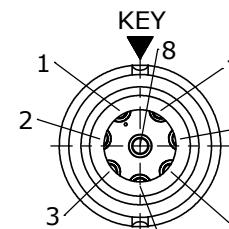

WIRING END
W6280-8SG-P-528

RoHS COMPLIANT

B	MA	02-24-21	ADDED W6280-XSG-P-526 TO CHART PER ECR 9544
A	MA	02-28-20	RELEASED PER PDR 16014-7
	PNK	01-15-18	PDR 16014
REV.	INIT.	DATE	DESCRIPTION
<small>ALL INFORMATION ILLUSTRATED IS THE PROPERTY OF CONXALL CORPORATION. UNAUTHORIZED DUPLICATION OR DISTRIBUTION OF THIS DOCUMENT IS PROHIBITED.</small>			ORIG. DRAWN BY: PNK DATE: 01-15-18 CHECKED BY:
<small>ALL UNITS ARE IN FEET, INCHES, FRACTION OF INCHES AND DECIMALS. UNLESS OTHERWISE SPECIFIED TOLERANCES: 3 PLACE DECIMALS ±.010 ANGLES ±1° FRACTIONS ±1/16</small>			APPROVED BY: _____ TITLE: CABLE-END ASSEMBLY 2-8 #20 SOCKET CONTACTS, CRIMP INSTA-CLICK™ MINI-CON-X CUSTOMER: STANDARD PRODUCT
FILE:	W6280-XSG-P-5XX	DIRECTORY:	SLW
PART NUMBER: W6280-XSG-P-5XX			REV B

CUSTOMER PRINT

PART NUMBER: W6280-XSG-P-5XX

X-ON Electronics

Largest Supplier of Electrical and Electronic Components

Click to view similar products for [Standard Circular Connector](#) category:

Click to view products by [Switchcraft](#) manufacturer:

Other Similar products are found below :

[5M2530B10P](#) [600259N006](#) [600273N007](#) [6134-336-13149](#) [6134-337-11149](#) [6134-337-2390](#) [6134-341-17149](#) [6280-4SG-516](#) [6280-7SG-3DC](#)
[6290](#) [6291A](#) [66200A-10](#) [680-SMG](#) [681-PMG](#) [CXS3102A14S2P](#) [CXS3102A181S](#) [7271-6SG-300](#) [7282-3PG-300-CH3](#) [75-474014-05S](#) [75-](#)
[474618-01S](#) [75-474618-04P](#) [75-474618-04S](#) [799539-000](#) [MI8-SE](#) [805-005-07NF11-19PC](#) [805-005-07NF15-7PA](#) [8280-4PG-516](#) [8280-7PG-](#)
[519](#) [8282-5PG-519](#) [836783-1](#) [MP-4102-25P-C](#) [862256-1](#) [864019-2](#) [866857-1](#) [867865-1](#) [PT01SP-14-18P](#) [PT08P-14-5S](#) [120-1833-000](#)
[QCM019PC2DC012B](#) [1-2069279-1](#) [121583-0217](#) [121667-0020](#) [129591AU](#) [1000B BULK](#) [RD10A16-19-P6CS051/1](#) [RD10A20-31-](#)
[P8CS051/1](#) [RD16A14-12-S6CS051/2](#) [1301240290](#) [1301240347](#) [1301860202](#) [1301240268](#)