

CUSTOMER PRINT

PART NUMBER: W6380-XPG-P-3XX

**NOTES:**

1. ALL PARTS TO BE BULK PACKED.
2. CONTACTS ARE SUPPLIED UNASSEMBLED
3. ALL DIMENSIONS ARE REFERENCE EXCEPT THOSE WITH A TOLERANCE
4. DIMENSIONS IN BRACKETS [ ] ARE IN MILLIMETERS

ASS'Y P/N	GROMMET SIZE
W6380-XPG-P-311	CABLE O.D. .09-.14 [2.3 - 3.6]
W6380-XPG-P-315	CABLE O.D. .15-.17 [3.8 - 4.3]
W6380-XPG-P-318	CABLE O.D. .18-.20 [4.6 - 5.1]
W6380-XPG-P-321	CABLE O.D. .21-.23 [5.3 - 5.8]

ASSEMBLY P/N	CONTACTS
W6380-2PG-P-3XX	2 #16
W6380-3PG-P-3XX	3 #16
W6380-4PG-P-3XX	4 #16
W6380-XPG-P-3XX	

GROMMET SIZE FOR SINGLE GROMMET OR "DC" FOR DAISY CHAIN

NUMBER OF CONTACTS

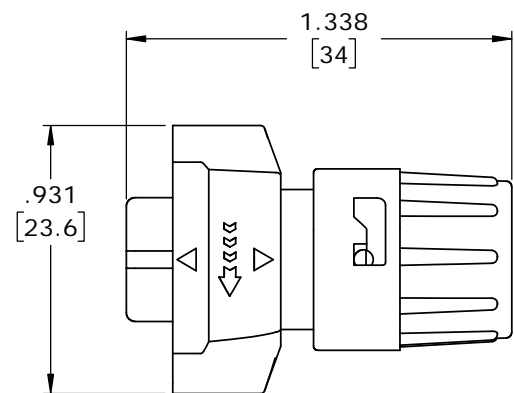

**SHOWN ASSEMBLED**  
FOR CUSTOMER REFERENCE ONLY

DAISY CHAIN GROMMETS  
FOR W6380-XPG-P-3DC  
.125 I.D. FOR CABLES .09-.14 [2.3 - 3.6] O.D.  
.188 I.D. FOR CABLES .18-.20 [4.6 - 5.1] O.D.  
.250 I.D. FOR CABLES .24-.26 [6.1 - 6.6] O.D.

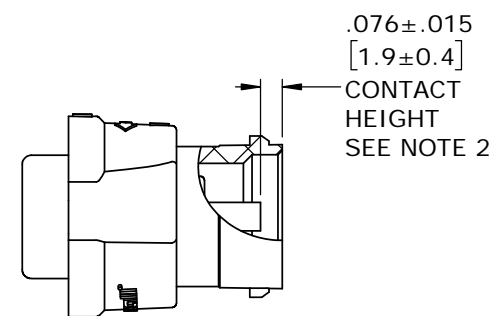

.076 ± .015  
[1.9 ± 0.4]  
CONTACT  
HEIGHT  
SEE NOTE 2

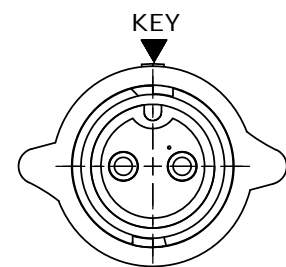
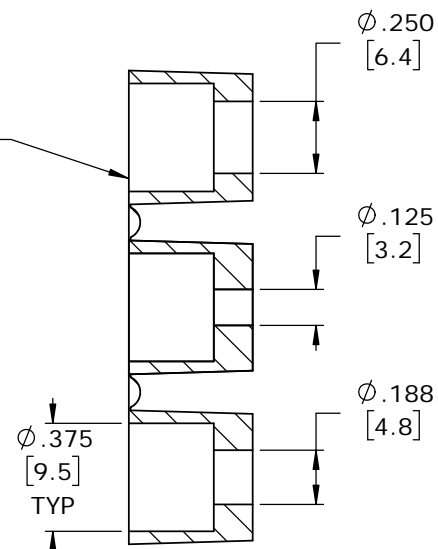

**MATING FACE**  
W6380-2PG-P-3XX SHOWN

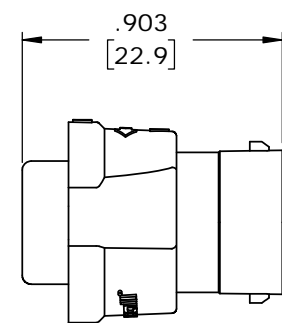

CABLE-END HOUSING  
MAT'L: UV PBT, BLACK  
COUPLING RING  
MAT'L: UV PBT, BLACK  
O-RING  
MAT'L: SILICONE, RED  
SPRING  
MAT'L: STAINLESS STEEL

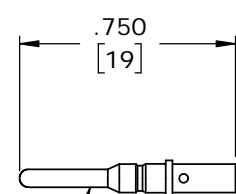

(2-4) #16 PIN CONTACT, CRIMP  
MAT'L: COPPER ALLOY, GOLD PLATED

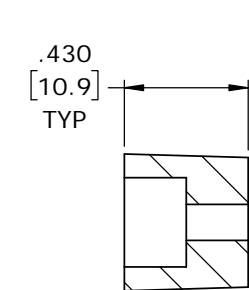

GROMMET  
MAT'L: SANTOPRENE, BLACK

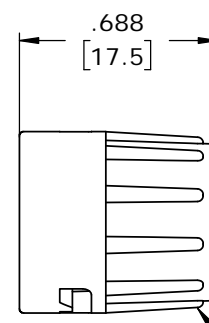

BACKSHELL  
MAT'L: UV PBT, BLACK

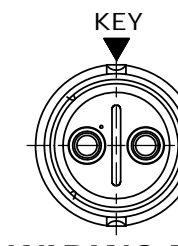

**WIRING END**  
W6380-2PG-P-3XX SHOWN  
WITHOUT HARDWARE

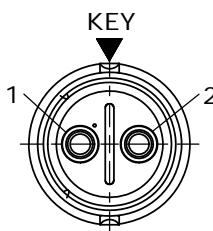

**WIRING END**  
W6380-2PG-P-3XX

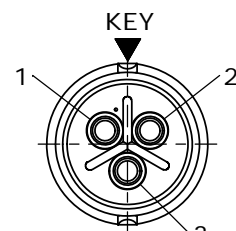

**WIRING END**  
W6380-3PG-P-3XX

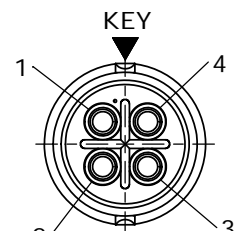

**WIRING END**  
W6380-4PG-P-3XX

**CUSTOMER APPROVAL**

THIS DOCUMENT CONTAINS CONFIDENTIAL INFORMATION PROPRIETARY TO CONXALL CORPORATION. ANY REPRODUCTION, DISCLOSURE, OR USE OF THIS DOCUMENT / INFORMATION IS EXPRESSLY PROHIBITED UNLESS AUTHORIZED IN WRITING BY CONXALL CORPORATION.

APPROVED BY: \_\_\_\_\_  
DATE: \_\_\_\_\_

**RoHS COMPLIANT**

REV.	INIT.	DATE	DESCRIPTION
A	MA	02-28-20	RELEASED PER PDR 16014-7
	PNK	11-25-19	BACKSHELL P/N 6284 CHANGES TO 6284V4
	PNK	05-10-19	PDR 16014

ALL INFORMATION ILLUSTRATED IS THE PROPERTY OF CONXALL CORPORATION. UNAUTHORIZED DUPLICATION OR DISTRIBUTION OF THIS DOCUMENT IS PROHIBITED.	ORIG. DRAWN BY: PNK DATE: 05-10-19	
ALL UNITS ARE IN FEET, INCHES, FRACTION OF INCHES AND DECIMALS. UNLESS OTHERWISE SPECIFIED TOLERANCES: 3 PLACE DECIMALS ± 0.10 ANGLES ± 1° FRACTIONS ± 1/16 - CRITICAL CHARACTERISTIC FLAG PER SPEC. XXXX	CHECKED BY:	
APPROVED BY:	SCALE: NTS SIZE: B SHEET: 1 OF 1	TITLE: CABLE-END ASSEMBLY 2-4 #16 PIN CONTACTS, CRIMP INSTA-CLICK™ MINI-CON-X STANDARD PRODUCT
FILE: W6380-XPG-P-3XX	DIRECTORY: SLW	CUSTOMER: W6380-XPG-P-3XX

## X-ON Electronics

Largest Supplier of Electrical and Electronic Components

*Click to view similar products for [Standard Circular Connector](#) category:*

*Click to view products by [Switchcraft](#) manufacturer:*

Other Similar products are found below :

[5M2530B10P](#) [600259N006](#) [600273N007](#) [6134-336-13149](#) [6134-337-11149](#) [6134-337-2390](#) [6134-341-17149](#) [6280-4SG-516](#) [6280-7SG-3DC](#)  
[6290](#) [6291A](#) [66200A-10](#) [680-SMG](#) [681-PMG](#) [CXS3102A14S2P](#) [CXS3102A181S](#) [7251-5SG-300](#) [7271-6SG-300](#) [7282-3PG-300-CH3](#) [75-](#)  
[474618-01S](#) [75-474618-04P](#) [75-474618-04S](#) [799539-000](#) [MI8-SE](#) [805-005-07NF11-19PC](#) [805-005-07NF15-7PA](#) [8280-4PG-516](#) [8280-7PG-](#)  
[519](#) [8282-5PG-519](#) [836783-1](#) [MP-4102-25P-C](#) [862256-1](#) [864019-2](#) [866857-1](#) [867865-1](#) [PT01SP-14-18P](#) [PT08P-14-5S](#) [PTSF06SE-14-12S](#)  
[120-1833-000](#) [QCM019PC2DC012B](#) [1-2069279-1](#) [121583-0217](#) [121667-0020](#) [129591AU](#) [1000B BULK](#) [RD10A16-19-P6CS051/1](#)  
[RD10A20-31-P8CS051/1](#) [RD16A14-12-S6CS051/2](#) [1301240290](#) [1301240347](#) [1301860202](#)