

CUSTOMER PRINT

PART NUMBER: W728X-XSG-P-3XX_CD

- NOTES:
1. CRIMP CONTACTS SUPPLIED UNASSEMBLED AND WITHOUT EPOXY BACKING.
 2. REFER TO DRAWING HPMISTD FOR CONTACT PATTERNS.
 3. HEX-NUT TORQUE: 8-10 IN-LB.
 4. DIMENSIONS ARE REFERENCE ONLY, IN INCHES [mm], WITHIN ±0.015 UNLESS OTHERWISE NOTED.

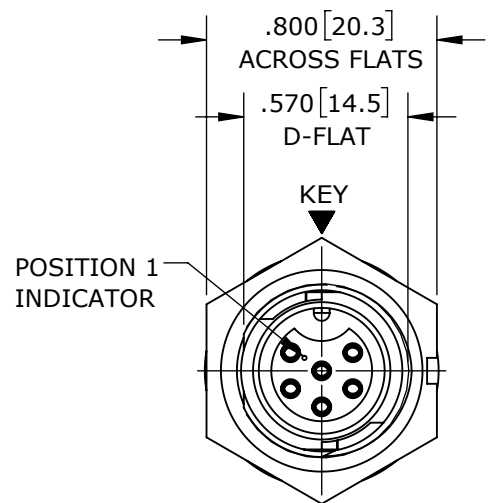

MATING FACE
W7282-6SG-P-300 SHOWN

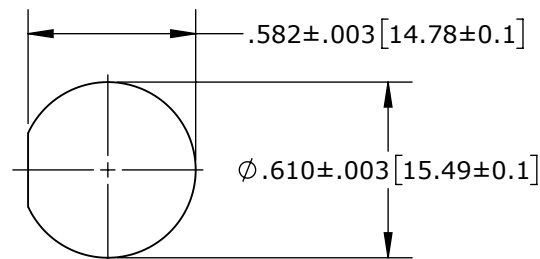

RECOMMENDED PANEL CUTOUT

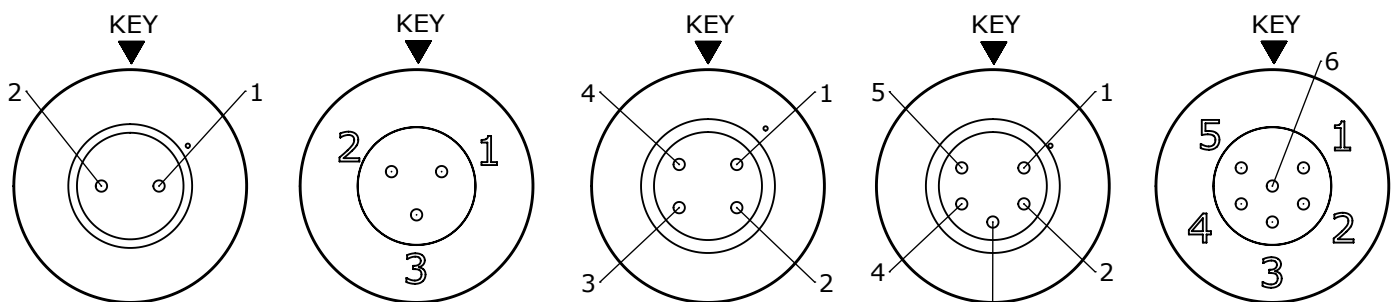

W7281-2SG-P-3ES W7281-3SG-P-3ES W7281-4SG-P-3ES W7281-5SG-P-3ES W7281-6SG-P-3ES

CONTACT ARRANGEMENTS (WIRING END SHOWN)

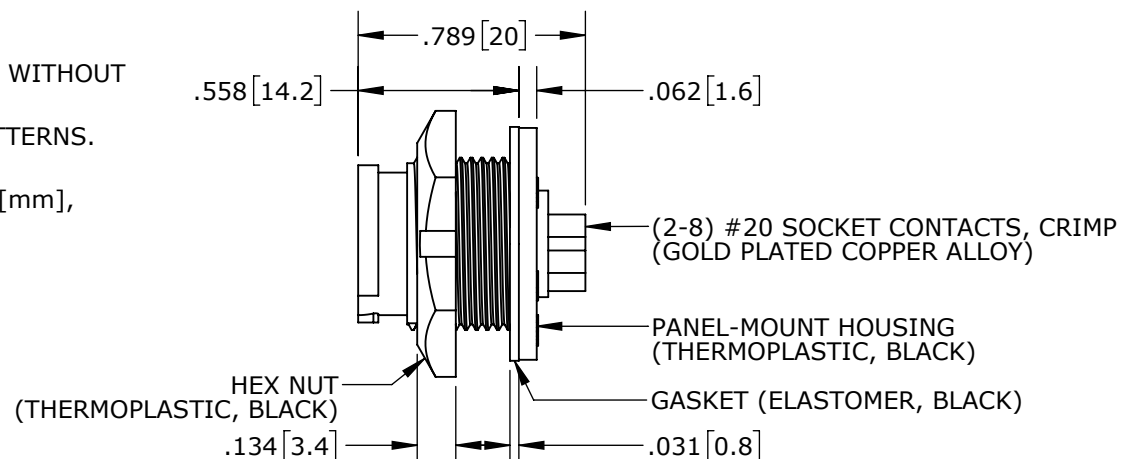

CRIMP CONTACTS (SHOWN ASSEMBLED)
W7280-6SG-P-300 SHOWN

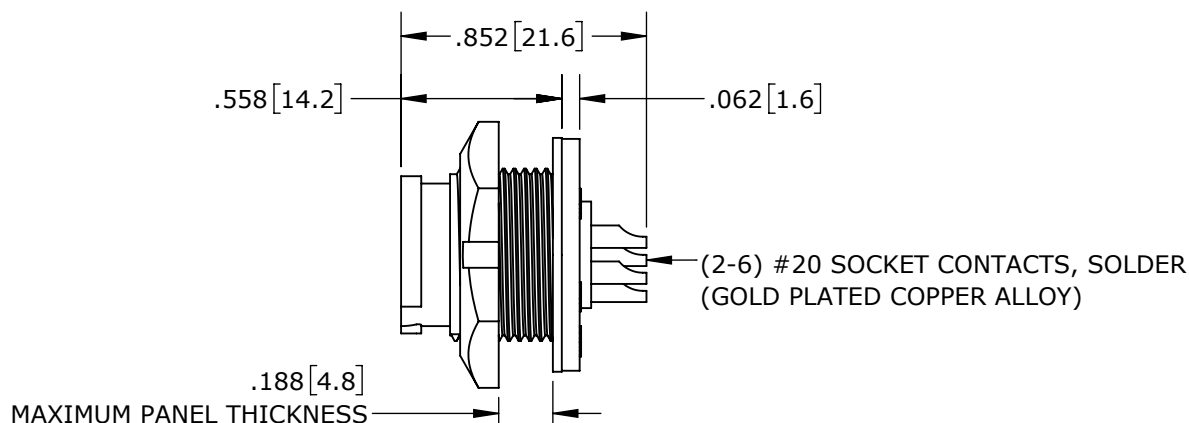

SOLDER CONTACTS
W7282-6SG-P-300 SHOWN

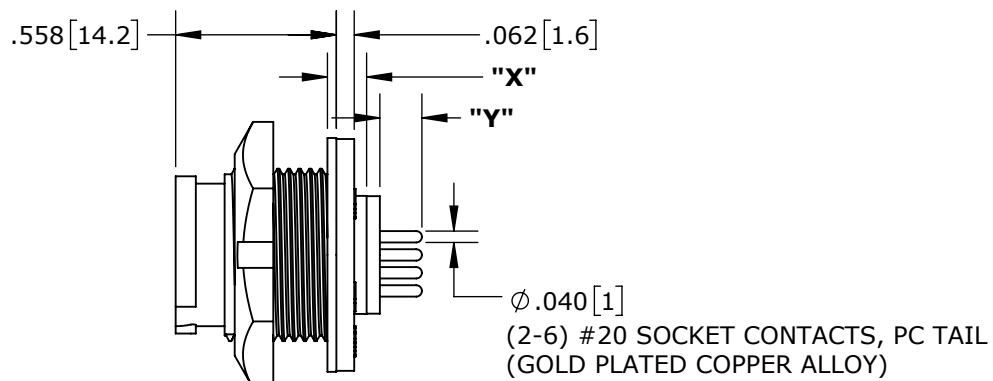

PC TAIL CONTACTS
W7281-6SG-P-3ES SHOWN

PANEL-MOUNT CONNECTOR PART NUMBERS:

W 7 2 8 X - X S G - P - 3XX

CONTACTS STYLE:
0 = CRIMP
2 = SOLDER
1 = PC TAIL

OF CONTACTS:
2-6 #20 SOCKETS

EPOXY BACKING:
3ES = WITH EPOXY
300 = WITHOUT EPOXY

CUSTOMER APPROVAL

THIS DOCUMENT CONTAINS CONFIDENTIAL INFORMATION PROPRIETARY TO CONXALL CORPORATION. ANY REPRODUCTION, DISCLOSURE, OR USE OF THIS DOCUMENT /INFORMATION IS EXPRESSLY PROHIBITED UNLESS AUTHORIZED IN WRITING BY CONXALL CORPORATION.

APPROVED BY: _____
DATE: _____

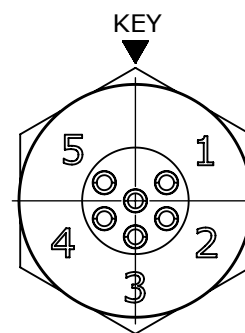

WIRING END
W7282-6SG-P-300 SHOWN

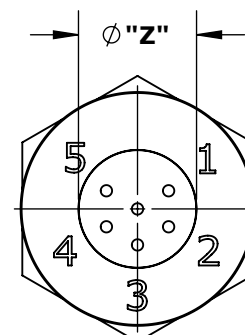

WIRING END
W7281-6SG-P-3ES SHOWN

PC CONTACT CONNECTORS DIMENSIONING:

PART NUMBER	"X"	"Y"	"Z"
W7281-2SG-P-300			
W7281-3SG-P-300			
W7281-4SG-P-300	.133 [3.4]	.195 [5]	.370 [9.4]
W7281-5SG-P-300			
W7281-6SG-P-300			
W7281-2SG-P-3ES	.183 [4.6]	.145 [3.7]	.430 [10.9]
W7281-3SG-P-3ES	.136 [3.5]	.192 [4.9]	.410 [10.4]
W7281-4SG-P-3ES	.183 [4.6]	.145 [3.7]	.465 [3.7]
W7281-5SG-P-3ES			
W7281-6SG-P-3ES	.136 [3.5]	.192 [4.9]	.410 [10.4]

0A	PNK	01-12-18	PDR16014
REV.	INIT.	DATE	DESCRIPTION
<small>ALL INFORMATION ILLUSTRATED IS THE PROPERTY OF CONXALL CORPORATION. UNAUTHORIZED DUPLICATION OR DISTRIBUTION OF THIS DOCUMENT IS PROHIBITED.</small>			ORIG. DRAWN BY: _____ DATE: 01-12-18 CHECKED BY: _____
<small>ALL UNITS ARE IN FEET, INCHES, FRACTION OF INCHES AND DECIMALS.</small>			APPROVED BY: _____ TITLE: PANEL-MOUNT CONNECTOR 2-6 #20 SOCKET CONTACTS INSTA-CLICK™ MINI-CON-X CUSTOMER: STANDARD PRODUCT
SCALE	SIZE	SHEET	PART NUMBER: W728X-XSG-P-3XX
NTS	B	1 OF 1	REV 0A
FILE:	DIRECTORY:	PART NUMBER:	
W728X-XSG-P-3XX_CD	SLW	W728X-XSG-P-3XX	

RoHS COMPLIANT

X-ON Electronics

Largest Supplier of Electrical and Electronic Components

Click to view similar products for [Standard Circular Connector](#) category:

Click to view products by [Switchcraft](#) manufacturer:

Other Similar products are found below :

[5M2530B10P](#) [600259N006](#) [600273N007](#) [6134-336-13149](#) [6134-337-11149](#) [6134-337-2390](#) [6134-341-17149](#) [6280-4SG-516](#) [6280-7SG-3DC](#)
[6290](#) [6291A](#) [66200A-10](#) [680-SMG](#) [681-PMG](#) [CXS3102A14S2P](#) [CXS3102A181S](#) [7251-5SG-300](#) [7271-6SG-300](#) [7282-3PG-300-CH3](#) [75-](#)
[474618-01S](#) [75-474618-04P](#) [75-474618-04S](#) [799539-000](#) [MI8-SE](#) [805-005-07NF11-19PC](#) [805-005-07NF15-7PA](#) [8280-4PG-516](#) [8280-7PG-](#)
[519](#) [8282-5PG-519](#) [836783-1](#) [MP-4102-25P-C](#) [862256-1](#) [864019-2](#) [866857-1](#) [867865-1](#) [PT01SP-14-18P](#) [PT08P-14-5S](#) [PTSF06SE-14-12S](#)
[120-1833-000](#) [QCM019PC2DC012B](#) [1-2069279-1](#) [121583-0217](#) [121667-0020](#) [129591AU](#) [1000B BULK](#) [RD10A16-19-P6CS051/1](#)
[RD10A20-31-P8CS051/1](#) [RD16A14-12-S6CS051/2](#) [1301240290](#) [1301240347](#) [1301860202](#)