

# Unshielded DIP Power Inductors



PK series Spike suppression coil



## ◆特征:

- 低成本
- 具有高功率, 高饱和和低电阻
- 非屏蔽功率电感
- 磁芯由 UL 热缩管包覆以提供优良的机械和环境保护
- 多种封装尺寸和宽电感范围
- 编带包装可用于自动插件
- 符合 RoHS, 无卤和 REACH

## Features:

- Low cost
- High power, High saturation, Low resistance
- Unshielded power inductor
- Core is encapsulated by UL heat shrink tube to provide excellent mechanic and environmental protection
- Various package size and wide inductance range
- Tape packaging for auto-insertion
- RoHS, Halogen Free and REACH Compliance

## ◆用途:

- 电视和音响设备
- 通信设备
- 噪声滤波器
- 充电器, 快充
- DC/DC 转换器

## Applications:

- TVs and Audio equipment
- Telecommunication devices
- Other noise filter
- Charger, fast charge
- DC/DC converters

## ◆环境:

- 工作温度: -40°C 至+125°C (包括线圈自身温升)

## Environmental Data:

- Operating Temperature: -40°C to +125°C (Including coils self-temperature rise)

## ◆试验设备:

- 电感值: HP4284A, HP4285A 或同等仪器
- 电流: HP4284+42841A
- 自谐振频率: HM 9461
- 品质因子: HP4285A
- 直流电阻: Chroma 16502 或同等仪器

## Test Equipment:

- L: HP4284A or HP4285A LCR meter or equivalent
- Isat & Irms: HP4284+42841A
- SRF: HM 9461
- Q: HP4285A
- DCR: Chroma 16502 or equivalent

## ◆产品型号:

## Product Identification:

**PK**

①

**0608**

②

**503**

③

**K**

④

**UL**

⑤

**TF**

⑥

①

类型 Type	
PK	径向引线固定电感 Raial Leded Fixed Inductors <b>I</b>

②

外形尺寸(L×W×H) (mm) External Dimensions (L×H) (mm)	
0608	7.0×11.0

③

Inductance
50 mH

④

公差 Inductance Tolerance
J:±5%,K: ±10%, L: ±15%
M: ±20%,P: ±25%, N: ±30%

⑤

套管 UL	
UL	Black UL125°C Tube
no code	No UL

⑥

包装 Packing	
B	散装 Bulk Package
TF	编带 Tape

◆外观尺寸:

Shape and Dimensions(dimensions are in mm):

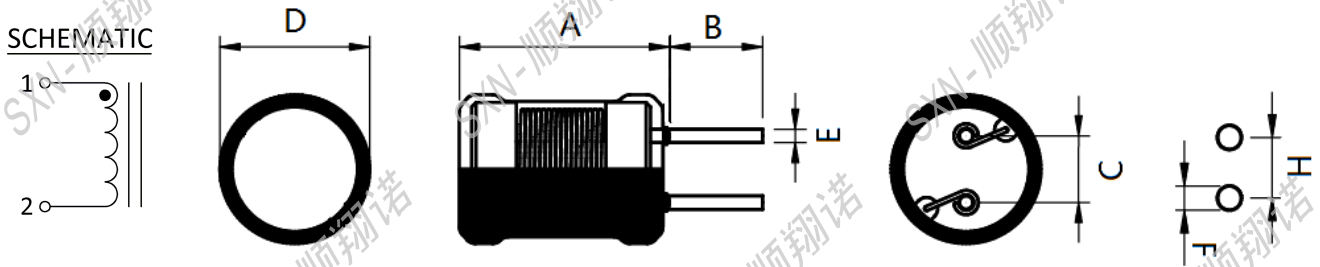

Marking is available if needed

如果需要，产品可印字

Reference  
holepattern

Part No	ITEM						
	A	B	C	D	E	F	H
PK0406	8.0 Max	15.0 Min	2.0±0.5	5.5 Max	0.55±0.1	0.85	2.0
PK0608	11.0 Max	15.0 Min	2.5±0.5	7.5 Max	0.65±0.1	0.95	2.5
PK0707	9.5 Max	15.0 Min	5.0±0.5	8.5 Max	0.65±0.1	0.95	5.0
PK0807	9.5 Max	15.0 Min	5.0±0.5	10.0 Max	0.65±0.1	0.95	5.0
PK0810	13.0 Max	15.0 Min	5.0±0.5	10.0 Max	0.65±0.1	0.95	5.0
PK0912	15.0 Max	15.0 Min	5.0±0.5	12.0 Max	0.80±0.1	1.1	5.0
PK1010	13.0 Max	15.0 Min	5.0±0.5	12.0 Max	0.80±0.1	1.1	5.0
PK1012	15.0 Max	15.0 Min	6.0±0.5	12.0 Max	0.80±0.1	1.1	6.0
PK1018	21.0 Max	15.0 Min	6.0±0.5	12.0 Max	0.80±0.1	1.1	6.0
PK1213	16.0 Max	15.0 Min	7.5±0.5	14.0 Max	0.80±0.1	1.1	7.5

◆规格特性:

Specifications:

● PK0406 Series Electrical Characteristics (Electrical specifications at 25°C)

Part No	Inductance		Q		SRF	DCR	Rated Current
	L(μH) @1KHz	Tole	Min	Test Freq.	(MHz) Min	(Ω) Max	(mA) Max
PK0406-1R0M-□□	1.0	M	100	7.96MHZ	120	0.035	2000
PK0406-1R2M-□□	1.2	M	100	7.96MHZ	120	0.058	1950
PK0406-1R5M-□□	1.5	M	100	7.96MHZ	120	0.075	1900
PK0406-1R8M-□□	1.8	M	100	7.96MHZ	120	0.110	1800
PK0406-2R2M-□□	2.2	M	100	7.96MHZ	100	0.120	1750
PK0406-2R7M-□□	2.7	M	100	7.96MHZ	80	0.125	1680
PK0406-3R3M-□□	3.3	M	100	7.96MHZ	75	0.130	1500
PK0406-3R9M-□□	3.9	M	100	7.96MHZ	70	0.135	1450
PK0406-4R7M-□□	4.7	M	100	7.96MHZ	50	0.140	1320
PK0406-5R6M-□□	5.6	M	100	7.96MHZ	45	0.145	1230
PK0406-6R8M-□□	6.8	M	100	7.96MHZ	30	0.15	1150
PK0406-8R2M-□□	8.2	M	100	7.96MHZ	22	0.16	1100
PK0406-100M-□□	10	M	80	2.52MHZ	20	0.23	1000
PK0406-120M-□□	12	M	80	2.52MHZ	17	0.24	970
PK0406-150M-□□	15	M	80	2.52MHZ	16	0.25	920
PK0406-180M-□□	18	M	80	2.52MHZ	12	0.33	860
PK0406-220M-□□	22	M	80	2.52MHZ	10	0.45	800
PK0406-270M-□□	27	M	80	2.52MHZ	9.5	0.50	710
PK0406-330M-□□	33	M	80	2.52MHZ	8.7	0.70	660
PK0406-390M-□□	39	M	70	2.52MHZ	8.2	0.74	600
PK0406-470M-□□	47	M	70	2.52MHZ	7.8	0.76	550
PK0406-560M-□□	56	M	50	2.52MHZ	7.6	0.80	500
PK0406-680M-□□	68	M	50	2.52MHZ	6.8	0.90	470
PK0406-820M-□□	82	M	50	2.52MHZ	6.0	0.95	430
PK0406-101K-□□	100	K	45	796KHZ	6.0	1.00	400
PK0406-121K-□□	120	K	45	796KHZ	5.5	1.10	370
PK0406-151K-□□	150	K	65	796KHZ	4.2	1.30	350
PK0406-181K-□□	180	K	65	796KHZ	3.6	1.50	320
PK0406-221K-□□	220	K	65	796KHZ	2.8	1.80	300
PK0406-271K-□□	270	K	50	796KHZ	2.4	1.90	275
PK0406-331K-□□	330	K	50	796KHZ	2.2	2.20	250

Part No	Inductance		Q		SRF	DCR	Rated Current
	L(μH) '@1KHz	Tole	Min	Test Freq.	(MHz) Min	(Ω) Max	(mA) Max
PK0406-391K-□□	390	K	50	796KHZ	2.0	2.70	220
PK0406-471K-□□	470	K	50	796KHZ	1.7	3.60	200
PK0406-561K-□□	560	K	50	796KHZ	1.5	4.20	190
PK0406-681K-□□	680	K	50	796KHZ	1.3	4.60	170
PK0406-821K-□□	820	K	50	796KHZ	1.1	5.70	155
PK0406-122K-□□	1200	K	90	252KHZ	0.9	8.20	140
PK0406-152K-□□	1500	K	80	252KHZ	0.8	13.00	120
PK0406-182K-□□	1800	K	80	252KHZ	0.8	15.00	110
PK0406-222K-□□	2200	K	80	252KHZ	0.8	17.00	100
PK0406-272K-□□	2700	K	80	252KHZ	0.8	19.00	90
PK0406-332K-□□	3300	K	70	252KHZ	0.7	26.00	83
PK0406-392K-□□	3900	K	70	252KHZ	0.6	30.00	76
PK0406-472K-□□	4700	K	65	252KHZ		45.00	70
PK0406-562K-□□	5600	K	65	252KHZ		48.00	62
PK0406-682K-□□	6800	K	65	252KHZ		56.00	56
PK0406-822K-□□	8200	K	65	252KHZ		62.00	52
PK0406-103K-□□	10000	K	45	79.6KHZ		72.00	47
PK0406-153K-□□	15000	K	45	79.6KHZ		120.00	35
PK0406-223K-□□	22000	K	45	79.6KHZ		160.00	24
PK0406-253K-□□	25000	K	45	79.6KHZ		180.00	20

● PK0608 Series Electrical Characteristics (Electrical specifications at 25°C)

Part No	Inductance		Q		SRF	DCR	Rated Current
	L(μH) '@1KHz	Tole	Min	Test Freq.	(MHz) Min	(Ω) Max	(mA) Max
PK0608-3R3M-□□	3.3	M	20	7.96MHZ	40.0	0.016	3500
PK0608-4R7M-□□	4.7	M	20	7.96MHZ	36.0	0.020	3000
PK0608-6R8M-□□	6.8	M	20	7.96MHZ	32.0	0.022	2500
PK0608-100M-□□	10	M	30	2.52MHZ	23.0	0.039	2000
PK0608-150M-□□	15	M	30	2.52MHZ	19.0	0.045	1700
PK0608-220M-□□	22	M	30	2.52MHZ	16.0	0.062	1400
PK0608-330M-□□	33	M	30	2.52MHZ	11.0	0.10	1100
PK0608-470M-□□	47	M	30	2.52MHZ	9.5	0.15	950

Part No	Inductance		Q		SRF	DCR	Rated Current
	L(μH) '@1KHz	Tole	Min	Test Freq.	(MHz) Min	(Ω) Max	(mA) Max
PK0608-680M-□□	68	M	30	2.52MHZ	9.0	0.22	800
PK0608-101K-□□	100	K	20	796KHZ	6.5	0.35	650
PK0608-151K-□□	150	K	20	796KHZ	5.5	0.43	540
PK0608-221K-□□	220	K	20	796KHZ	4.8	0.90	440
PK0608-331K-□□	330	K	20	796KHZ	3.7	1.50	350
PK0608-471K-□□	470	K	20	796KHZ	2.8	1.80	300
PK0608-681K-□□	680	K	20	796KHZ	2.5	2.50	250
PK0608-102K-□□	1000	K	100	252KHZ	2.1	3.20	200
PK0608-122K-□□	1200	K	70	252KHZ		3.50	180
PK0608-182K-□□	1800	K	70	252KHZ		5.00	155
PK0608-222K-□□	2200	K	70	252KHZ		6.80	140
PK0608-272K-□□	2700	K	70	252KHZ		7.20	125
PK0608-332K-□□	3300	K	70	252KHZ		10.50	115
PK0608-392K-□□	3900	K	70	252KHZ		11.70	105
PK0608-472K-□□	4700	K	70	252KHZ		13.60	95
PK0608-562K-□□	5600	K	70	252KHZ		16.60	85
PK0608-682K-□□	6800	K	70	252KHZ		19.60	80
PK0608-822K-□□	8200	K	70	252KHZ		25.20	70
PK0608-103K-□□	10000	K	70	79.6KHZ		29.50	65
PK0608-123K-□□	12000	K	50	79.6KHZ		33.80	60
PK0608-153K-□□	15000	K	50	79.6KHZ		45.40	55
PK0608-183K-□□	18000	K	50	79.6KHZ		50.40	50
PK0608-223K-□□	22000	K	50	79.6KHZ		80.00	45
PK0608-303K-□□	30000	K	50	79.6KHZ		91.50	40
PK0608-333K-□□	33000	K	50	79.6KHZ		98.50	35
PK0608-393K-□□	39000	K	50	79.6KHZ		140.00	32
PK0608-473K-□□	47000	K	50	79.6KHZ		160.00	30
PK0608-503K-□□	50000	K	50	79.6KHZ		170.00	29
PK0608-563K-□□	56000	K	50	79.6KHZ		250.00	28
PK0608-683K-□□	68000	K	50	79.6KHZ		282.00	25
PK0608-823K-□□	82000	K	50	79.6KHZ		312.00	23
PK0608-104K-□□	100000	K	30	25.2KHZ		380.00	20
PK0608-124K-□□	120000	K	30	25.2KHZ		430.00	18
PK0608-154K-□□	150000	K	30	25.2KHZ		520.00	16

● PK0707 Series Electrical Characteristics (Electrical specifications at 25°C)

Part No	Inductance		Q		SRF	DCR	Saturation Current	Temperature Rise Current
	L(μH) '@1KHz	Tole	Min	Test Freq.	(MHz) Min	(Ω) Max	(A) Max	(A) Max
PK0707-1R0M-□□	1.0	M	10	7.96MHz	70	0.006	6600	5000
PK0707-1R5M-□□	1.5	M	10	7.96MHz	56	0.008	5400	4300
PK0707-2R2M-□□	2.2	M	10	7.96MHz	45	0.011	4000	3700
PK0707-3R3M-□□	3.3	M	10	7.96MHz	35	0.018	3600	2900
PK0707-4R7M-□□	4.7	M	10	7.96MHz	29	0.022	3100	2600
PK0707-6R8M-□□	6.8	M	10	7.96MHz	24	0.028	2500	2300
PK0707-100M-□□	10	M	20	2.52MHz	19	0.043	2100	1900
PK0707-150M-□□	15	M	20	2.52MHz	15	0.056	1700	1600
PK0707-220M-□□	22	M	20	2.52MHz	12	0.086	1400	1300
PK0707-330M-□□	33	M	20	2.52MHz	9.4	0.14	1100	1000
PK0707-470M-□□	47	M	20	2.52MHz	7.6	0.17	960	940
PK0707-680M-□□	68	M	20	2.52MHz	6.2	0.28	790	730
PK0707-101K-□□	100	K	20	7.96MHz	5.0	0.33	600	670
PK0707-151K-□□	150	K	20	7.96MHz	4.0	0.56	530	520
PK0707-221K-□□	220	K	20	7.96MHz	3.2	0.72	440	420
PK0707-331K-□□	330	K	20	7.96MHz	2.5	1.10	360	330
PK0707-471K-□□	470	K	20	7.96MHz	2.0	1.70	300	270
PK0707-681K-□□	680	K	20	7.96MHz	1.7	2.30	210	260
PK0707-102K-□□	1000	K	70	2.52MHz	1.3	4.30	200	190
PK0707-152K-□□	1500	K	50	2.52MHz	1.3	5.00	170	160

● PK0807 Series Electrical Characteristics (Electrical specifications at 25°C)

Part No	Inductance		Q		SRF	DCR	Saturation Current	Temperature Rise Current
	L(μH) '@1KHz	Tole	Min	Test Freq.	(MHz) Min	(Ω) Max	(A) Max	(A) Max
PK0807-2R2M-□□	2.2	M	10	7.96MHz	60	0.011	5500	4000
PK0807-3R3M-□□	3.3	M	10	7.96MHz	38	0.013	3800	3400
PK0807-4R7M-□□	4.7	M	10	7.96MHz	30	0.017	3700	3000
PK0807-6R8M-□□	6.8	M	10	7.96MHz	24	0.023	2800	2600
PK0807-100M-□□	10	M	20	2.52MHz	19	0.031	2500	2200
PK0807-150M-□□	15	M	20	2.52MHz	15	0.042	2000	1900
PK0807-220M-□□	22	M	20	2.52MHz	12	0.070	1600	1500

Part No	Inductance		Q		SRF	DCR	Saturation Current	Temperature Rise Current
	L(μH) '@1KHz	Tole	Min	Test Freq.	(MHz) Min	(Ω) Max	(A) Max	(A) Max
PK0807-330M-□□	33	M	20	2.52MHz	10	0.092	1300	1200
PK0807-470M-□□	47	M	20	2.52MHz	8.2	0.130	1100	1000
PK0807-680M-□□	68	M	20	2.52MHz	6.6	0.160	970	910
PK0807-101K-□□	100	K	15	796KHz	5.4	0.230	810	750
PK0807-151K-□□	150	K	15	796KHz	4.3	0.400	610	610
PK0807-221K-□□	220	K	15	796KHz	3.5	0.530	530	500
PK0807-331K-□□	330	K	15	796KHz	2.8	0.780	440	410
PK0807-471K-□□	470	K	10	796KHz	2.3	1.00	390	330
PK0807-681K-□□	680	K	10	796KHz	1.9	1.50	320	280
PK0807-102K-□□	1000	K	20	252KHz	1.5	2.20	260	230
PK0807-152K-□□	1500	K	30	252KHz	1.2	3.50	210	180

● PK0810 Series Electrical Characteristics (Electrical specifications at 25°C)

Part No	Inductance		Q		SRF	DCR	Rated Current
	L(μH) '@1KHz	Tole	Min	Test Freq.	(MHz) Min	(Ω) Max	(mA) Max
PK0810-3R3M-□□	3.3	M	30	7.96MHz	65	0.012	5000
PK0810-3R9M-□□	3.9	M	30	7.96MHz	55	0.014	4600
PK0810-4R7M-□□	4.7	M	30	7.96MHz	45	0.016	4300
PK0810-5R6M-□□	5.6	M	30	7.96MHz	38	0.020	3900
PK0810-6R8M-□□	6.8	M	30	7.96MHz	27	0.022	3700
PK0810-8R2M-□□	8.2	M	30	7.96MHz	21	0.024	3500
PK0810-100M-□□	10	M	50	2.52MHz	17	0.025	3.200
PK0810-120M-□□	12	M	50	2.52MHz	15	0.027	3.000
PK0810-150M-□□	15	M	50	2.52MHz	13	0.033	2.800
PK0810-180M-□□	18	M	50	2.52MHz	12	0.039	2.600
PK0810-220M-□□	22	M	50	2.52MHz	11	0.047	2.400
PK0810-270M-□□	27	M	50	2.52MHz	10	0.052	2.100
PK0810-330M-□□	33	M	50	2.52MHz	8.5	0.075	1900
PK0810-390M-□□	39	M	40	2.52MHz	7.7	0.082	1700
PK0810-470M-□□	47	M	40	2.52MHz	6.7	0.10	1500
PK0810-560M-□□	56	M	40	2.52MHz	6.4	0.15	1300
PK0810-680M-□□	68	M	30	2.52MHz	5.8	0.18	1200

Part No	Inductance		Q		SRF	DCR	Rated Current
	L(μH) '@1KHz	Tole	Min	Test Freq.	(MHz) Min	(Ω) Max	(mA) Max
PK0810-820M-□□	82	M	30	2.52MHz	5.2	0.20	1100
PK0810-101K-□□	100	K	30	796KHz	4.4	0.20	900
PK0810-121K-□□	120	K	30	796KHz	4.2	0.22	800
PK0810-151K-□□	150	K	30	796KHz	3.7	0.24	720
PK0810-181K-□□	180	K	30	796KHz	3.5	0.28	650
PK0810-221K-□□	220	K	20	796KHz	3.3	0.35	600
PK0810-271K-□□	270	K	20	796KHz	2.9	0.40	550
PK0810-331K-□□	330	K	20	796KHz	2.6	0.47	500
PK0810-391K-□□	390	K	20	796KHz	2.4	0.68	460
PK0810-471K-□□	470	K	20	796KHz	2.2	0.80	420
PK0810-561K-□□	560	K	20	796KHz	2.0	1.00	380
PK0810-681K-□□	680	K	20	796KHz	1.8	1.20	350
PK0810-821K-□□	820	K	20	796KHz	1.7	1.50	310
PK0810-102K-□□	1000	K	40	252KHz	1.5	1.80	280
PK0810-122K-□□	1200	K	40	252KHz	1.4	2.00	250
PK0810-152K-□□	1500	K	40	252KHz	1.3	2.40	230
PK0810-182K-□□	1800	K	40	252KHz	1.1	2.80	210
PK0810-222K-□□	2200	K	40	252KHz	1.0	3.30	190
PK0810-272K-□□	2700	K	40	252KHz	0.88	5.00	170
PK0810-392K-□□	3900	K	40	252KHz	0.72	6.20	140
PK0810-472K-□□	4700	K	40	252KHz	0.65	7.00	130
PK0810-562K-□□	5600	K	40	252KHz	0.58	9.10	120
PK0810-682K-□□	6800	K	40	252KHz	0.55	10.00	110
PK0810-822K-□□	8200	K	20	252KHz	0.50	15.00	100
PK0810-103K-□□	10000	K	20	79.6KHz	0.42	24.00	90
PK0810-473K-□□	47000	K	60	79.6KHz	0.20	80.00	40
PK0810-104K-□□	100000	K	20	79.6KHz	0.14	180.00	28



● PK0912 Series Electrical Characteristics (Electrical specifications at 25°C)

Part No	Inductance		DCR	Rated Current
	L(μH) '@1KHz	Tole	(Ω) Max	(A) Max
PK0912-3R3M-□□	3.3	M	0.017	4.80
PK0912-4R7M-□□	4.7	M	0.020	4.50
PK0912-6R8M-□□	6.8	M	0.025	4.20
PK0912-100M-□□	10	M	0.040	4.00
PK0912-120M-□□	12	M	0.045	3.80
PK0912-150M-□□	15	M	0.050	3.50
PK0912-180M-□□	18	M	0.060	3.20
PK0912-220M-□□	22	M	0.070	3.00
PK0912-270K-□□	27	M	0.10	2.80
PK0912-330K-□□	33	M	0.12	2.50
PK0912-390K-□□	39	M	0.12	2.00
PK0912-470K-□□	47	M	0.13	1.90
PK0912-560K-□□	56	M	0.14	1.80
PK0912-680K-□□	68	M	0.15	1.70
PK0912-820K-□□	82	K	0.16	1.60
PK0912-101K-□□	100	K	0.25	1.50
PK0912-121K-□□	120	K	0.28	1.20
PK0912-151K-□□	150	K	0.30	1.00
PK0912-181K-□□	180	K	0.45	0.70
PK0912-221K-□□	220	K	0.50	0.60
PK0912-271K-□□	270	K	0.65	0.50
PK0912-331K-□□	330	K	0.85	0.45
PK0912-391K-□□	390	K	0.95	0.40
PK0912-471K-□□	470	K	1.10	0.35
PK0912-561K-□□	560	K	1.20	0.30
PK0912-681K-□□	680	K	1.30	0.25
PK0912-821K-□□	820	K	1.50	0.20
PK0912-102K-□□	1000	K	2.00	0.20
PK0912-152K-□□	1500	K	2.30	0.18

Part No	Inductance		DCR	Rated Current
	L(μH) '@1KHz	Tole	(Ω) Max	(A) Max
PK0912-222K-□□	2200	K	4.50	0.15
PK0912-332K-□□	3300	K	5.50	0.13
PK0912-472K-□□	4700	K	7.20	0.12
PK0912-682K-□□	6800	K	12.00	0.10
PK0912-103K-□□	10000	K	16.00	0.09
PK0912-153K-□□	15000	K	21.00	0.08
PK0912-223K-□□	22000	K	33.00	0.07
PK0912-333K-□□	33000	K	45.00	0.04

● PK1010 Series Electrical Characteristics (Electrical specifications at 25°C)

Part No	Inductance		Q	SRF	DCR	Saturation Current	Temperature Rise Current	
	L(μH) '@1KHz	Tole						Test Freq.
PK1010-3R3M-□□	3.3	M	10	7.96MHz	36	0.010	8800	5900
PK1010-4R7M-□□	4.7	M	10	7.96MHz	28	0.015	7200	4800
PK1010-6R8M-□□	6.8	M	10	7.96MHz	18	0.016	6700	4600
PK1010-100M-□□	10	M	20	2.52MHz	16	0.025	5000	3700
PK1010-150M-□□	15	M	20	2.52MHz	12	0.029	4200	3400
PK1010-200M-□□	22	M	20	2.52MHz	9.5	0.040	3400	2900
PK1010-330M-□□	33	M	20	2.52MHz	7.0	0.062	2800	3300
PK1010-470M-□□	47	M	20	2.52MHz	5.8	0.075	2300	2100
PK1010-680M-□□	68	M	20	2.52MHz	4.7	0.13	1900	1600
PK1010-101K-□□	100	K	20	796KHz	3.8	0.16	1600	1400
PK1010-151K-□□	150	K	20	796KHz	3.1	0.26	1300	1100
PK1010-221K-□□	220	K	20	796KHz	2.5	0.33	1100	1000
PK1010-331K-□□	330	K	20	796KHz	2.0	0.52	880	820
PK1010-471K-□□	470	K	10	796KHz	1.6	0.66	750	720
PK1010-681K-□□	680	K	10	796KHz	1.3	1.10	610	560
PK1010-102K-□□	1000	K	20	252KHz	1.1	1.40	510	500
PK1010-152K-□□	1500	K	30	252KHz	0.82	2.40	430	380
PK1010-222K-□□	2200	K	20	252KHz	0.76	3.20	350	330
PK1010-332K-□□	3300	K	30	252KHz	0.64	4.90	280	260

Part No	Inductance		Q		SRF	DCR	Saturation Current	Temperature Rise Current
	L(μH) '@1KHz	Tole	Min	Test Freq.	(MHz) Min	(Ω) Max	(A) Max	(A) Max
PK1010-472K-□□	4700	K	30	252KHz	0.54	7.60	240	210
PK1010-682K-□□	6800	K	30	252KHz	0.45	9.80	200	180
PK1010-103K-□□	10000	K	30	79.6KHz	0.38	18.00	170	140
PK1010-153K-□□	15000	K	50	79.6KHz	0.29	24.00	130	120

● PK1012 Series Electrical Characteristics (Electrical specifications at 25°C)

Part No	Inductance		Q		SRF	DCR	Saturation Current	Temperature Rise Current
	L(μH) '@1KHz	Tole	Min	Test Freq.	(MHz) Min	(Ω) Max	(A) Max	(A) Max
PK1012-103K-□□	10000	K	100	79.6KHz	0.35	12.00	180	170
PK1012-123K-□□	12000	K	100	79.6KHz	0.31	13.00	160	160
PK1012-153K-□□	15000	K	100	79.6KHz	0.28	18.00	140	140
PK1012-183K-□□	18000	K	80	79.6KHz	0.26	25.00	130	120
PK1012-223K-□□	22000	K	80	79.6KHz	0.22	30.00	120	110
PK1012-273K-□□	27000	K	80	79.6KHz	0.20	35.00	110	100
PK1012-333K-□□	33000	K	60	79.6KHz	0.19	40.00	100	90
PK1012-393K-□□	39000	K	60	79.6KHz	0.17	50.00	90	80
PK1012-473K-□□	47000	K	60	79.6KHz	0.15	50.00	80	75
PK1012-563K-□□	56000	K	40	79.6KHz	0.13	65.00	75	70
PK1012-683K-□□	68000	K	40	79.6KHz	0.12	70.00	70	65
PK1012-823K-□□	82000	K	30	79.6KHz	0.10	100.00	60	55
PK1012-104K-□□	100000	K	30	79.6KHz	0.10	135.00	55	45

● PK1018 Series Electrical Characteristics (Electrical specifications at 25°C)

Part No	Inductance		DCR	Saturation Current	Temperature Rise Current
	L(μH) '@1KHz	Tole	(Ω) Max	(A) Max	(A) Max
PK1018-4R7K-□□	4.7	K	0.008	10000	6000
PK1018-6R8K-□□	6.8	K	0.011	8000	5000
PK1018-100K-□□	10	K	0.017	7000	4500
PK1018-150K-□□	15	K	0.022	5500	4000
PK1018-220K-□□	22	K	0.026	4500	3700
PK1018-330K-□□	33	K	0.032	3800	3300
PK1018-470K-□□	47	K	0.035	3200	3000
PK1018-680K-□□	68	K	0.047	2600	2600
PK1018-101K-□□	100	K	0.090	2200	2000
PK1018-151K-□□	150	K	0.129	1800	1600
PK1018-221K-□□	220	K	0.162	1500	1500
PK1018-331K-□□	330	K	0.212	1200	1200
PK1018-471K-□□	470	K	0.380	1000	1000
PK1018-681K-□□	680	K	0.548	840	840
PK1018-102K-□□	1000	K	0.844	660	660
PK1018-152K-□□	1500	K	1.18	550	550
PK1018-222K-□□	2200	K	2.00	460	440
PK1018-332K-□□	3300	K	2.53	380	380
PK1018-472K-□□	4700	K	3.19	320	320
PK1018-682K-□□	6800	K	5.69	260	250
PK1018-103K-□□	10000	K	7.300	220	220
PK1018-153K-□□	15000	K	10.50	180	180
PK1018-223K-□□	22000	K	21.80	140	130
PK1018-333K-□□	33000	K	25.70	120	120
PK1018-473K-□□	47000	K	36.10	100	100
PK1018-683K-□□	68000	K	57.30	80	80
PK1018-104K-□□	100000	K	89.70	60	60

● PK1213 Series Electrical Characteristics (Electrical specifications at 25°C)

Part No	Inductance		DCR	Saturation Current	Temperature Rise Current
	L(μH) '@1KHz	Tole	(Ω) Max	(A) Max	(A) Max
PK1213-100M-□□	10	M	0.023	8000	5100
PK1213-150M-□□	15	M	0.028	6500	4500
PK1213-220M-□□	22	M	0.035	5500	4200
PK1213-330M-□□	33	M	0.043	4500	3700
PK1213-470M-□□	47	M	0.052	3600	3400
PK1213-680M-□□	68	M	0.068	3100	3000
PK1213-101K-□□	100	K	0.097	2600	2500
PK1213-151K-□□	150	K	0.14	2100	2100
PK1213-221K-□□	220	K	0.20	1700	1700
PK1213-331K-□□	330	K	0.30	1400	1400
PK1213-471K-□□	470	K	0.43	1100	1100
PK1213-681K-□□	680	K	0.61	950	990
PK1213-102K-□□	1000	K	1.00	780	780
PK1213-152K-□□	1500	K	1.30	640	680
PK1213-222K-□□	2200	K	2.00	530	550
PK1213-332K-□□	3300	K	3.10	430	440
PK1213-472K-□□	4700	K	4.40	360	370
PK1213-682K-□□	6800	K	6.50	300	300
PK1213-103K-□□	10000	K	10.00	240	240

- Saturation Current: DC current at which inductance drops 10% from its value without current
- Temperature Rise Current: the actual value of DC current when the temperature rise is  $\Delta T 40^{\circ}\text{C}$  ( $T_a=25^{\circ}\text{C}$ )
- Rated DC Current: The less value which is Isat or Irms
- Special remind: Circuit design, component, PCB trace size and thickness, airflow and other cooling provisions all affect the part temperature. Part temperature should be verified in the end application

## ◆产品包装:

- In bag pakeage

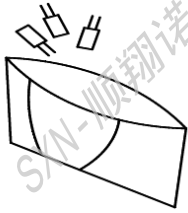

PE 袋

## Packaging:

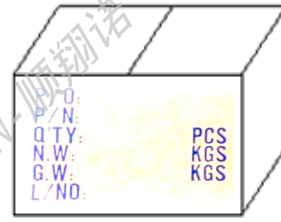

Outside Carton

不足整箱用内盒或填充物装满

Part No.	PE 胶袋每袋数量	外箱
PK0406	1000PCS	20,000PCS
PK0608	1000PCS	20,000PCS
PK0707	500PCS	10,000PCS
PK0807	500PCS	10,000PCS
PK0810	500PCS	10,000PCS
PK0912	200PCS	4000PCS
PK1010	200PCS	4000PCS
PK1012	200PCS	4000PCS
PK1018	200PCS	4000PCS
PK1213	200PCS	4000PCS

## ● Tape Specifications(mm)

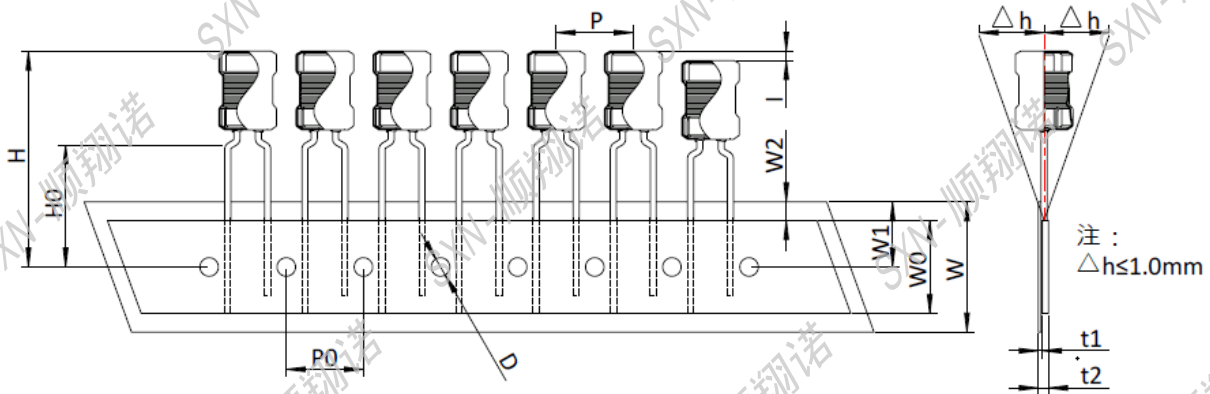

W	W0	W1	W2	P	P0	H	H0	D	t1	t2
18±1.0	12.5min	9.0±0.5	3.0max	12.7±1.0	12.7±0.3	32.0max	16.0min	4.0±0.3	0.35~0.6	0.86~1.5

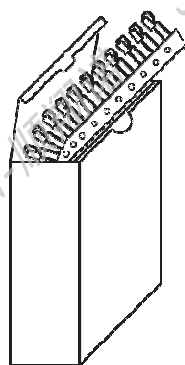

INSIDE BOX

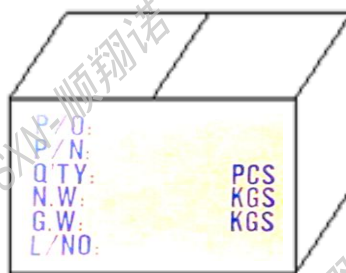



Outside Carton  
不足整箱用内盒或填充物装满

Part No.	INSIDE BOX	外箱
PK0406	1000PCS	10,000PCS
PK0608	750PCS	7500PCS
PK0707	750PCS	7500PCS
PK0807	600PCS	6000PCS
PK0810	600PCS	6000PCS
PK0912	500PCS	5000PCS
PK1010	500PCS	5000PCS
PK1012	500PCS	5000PCS

## ◆可靠性测试:

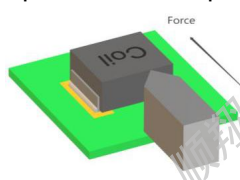
## Reliability Testing:

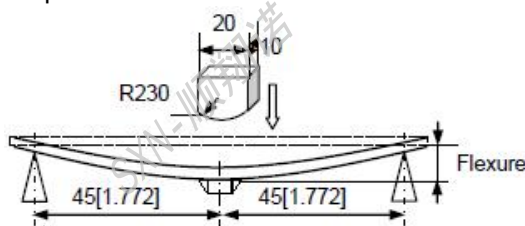
Items	Requirements	Test Methods and Remarks
Terminal Strength Reference documents: GB/T 2423.60-2008 端子强度(SMT)	1. Pulling test: Define: A: sectional area of terminal $A \leq 8\text{mm}^2$ force $\geq 5\text{N}$ time: 30sec $8\text{mm}^2 < A \leq 20\text{mm}^2$ force $\geq 10\text{N}$ time: 10sec $20\text{mm}^2 < A$ force $\geq 20\text{N}$ time: 10sec 2. Solder paste thickness: 0.12mm 3. Meet the above requirements without any loose terminal	Solder the inductor to the testing jig using leadfree solder. Then apply a force in the Keep time: $10 \pm 1\text{s}$ Speed: 1.0mm/s. 
Terminal Strength Reference documents: GB/T 2423.60-2008 端子强度(DIP)	1. Terminal diameter (d) mm $0.35 < d \leq 0.50$ Applied force: 5N Duration: 10sec 2. Terminal diameter (d) mm $0.50 < d \leq 0.80$ Applied force: 10N Duration: 10sec 3. Terminal diameter (d) mm $0.80 < d \leq 1.25$ Applied force: 20N Duration: 10sec 4. Terminal diameter (d) mm $D > 1.25$ Applied force: 40N Duration: 10sec 5. Meet the above requirements without any loose terminal.	Pull Force: the force shall be applied gradually to the terminal and then maintained for 10 seconds. 
Resistance to Flexure JIS C 5321:1997 抗弯曲性试验	1. No visible mechanical damage.	1. Solder the inductor to the test jig (glass epoxy board 2. shown in Using a leadfree solder. Then apply a force in the direction shown 3. Flexure: 2mm. 4. Pressurizing Speed: 0.5mm/sec. 5. Keep time: 30 sec. 
Dropping Reference documents: GB/T 2423.7-2018 落下试验	1. No case deformation or change in appearance. 2. No short and no open.	1. Drop the packaged products from 1m high in 1 angle, 3 ridges and 6 surfaces, twice in each direction.
Solderability Reference documents: GB/T 2423.28-2005 可焊性试验	1. No visible mechanical damage. 2. Wetting shall exceed 75% coverage for 3. Terminals must have 95% minimum solder coverage	1. Solder temperature: $240 \pm 2^\circ\text{C}$ 2. Duration: 3 sec. 3. Solder: Sn/3.0Ag/0.5Cu. 4. Flux: 25% Resin and 75% ethanol in weight

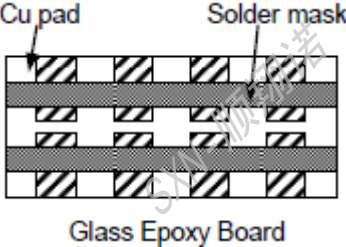
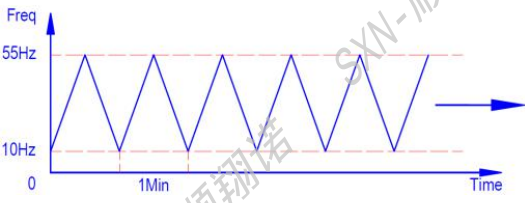
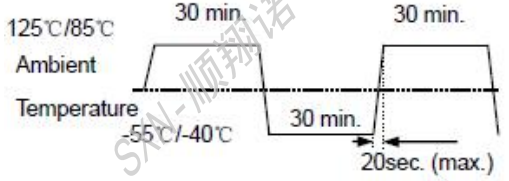
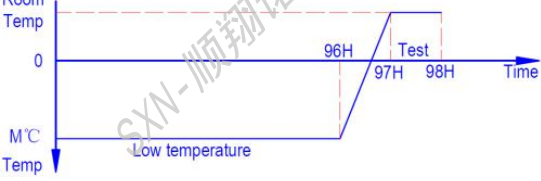

Items	Requirements	Test Methods and Remarks
<p>Vibration</p> <p>Reference documents: GB/T 2423.10-2019</p> <p>振動試驗</p>	<p>1.No visible mechanical damage.</p> <p>2. Inductance change: Within <math>\pm 10\%</math>.</p> <p>3. Q factor change: Within <math>\pm 20\%</math>.</p> 	<p>1.Solder the inductor to the testing jig (glass epoxy boardshown in ) using leadfree solder.</p> <p>2.The inductor shall be subjected to a simple harmonic motion having total amplitude of 1.5mm, the frequency being varied uniformly between the approximate limits of 10 and 55 Hz.</p> <p>3.The frequency range from 10 to 55 Hz and return to 10 Hz shall be traversed in approximately 1 minute. This motion shall be applied for a period of 2 hours in each 3 mutually perpendicular directions(total of 6 hours).</p> 
<p>Thermal Shock</p> <p>Reference documents: GB/T 2423.22-2012</p> <p>Method Na</p> <p>冷热冲击试验</p>	<p>1.No visible mechanical damage.</p> <p>2. Inductance change: Within <math>\pm 10\%</math>.(Mn-Zn: Within <math>\cong 30\%</math> )</p> <p>3. Q factor change: Within <math>\pm 20\%</math>.</p>	<p>1.Start at ( 85~125℃ ) for T time, rush to (-55~40℃ ) for T time as one cycle, go through 100 cycles.</p> <p>2.Transforming interval: Max. 20 sec.</p> <p>3.Tested cycle: 100 cycles.</p> <p>4.The chip shall be stabilized at normal condition for 1~2 hours</p> 
<p>Low temperature Storage</p> <p>Reference documents: GB/T 2423.1-2008</p> <p>Method Ab</p> <p>低温储存试验</p>	<p>1.No visible mechanical damage.</p> <p>2. Inductance change: Within <math>\pm 10\%</math>.(Mn-Zn: Within <math>\cong 30\%</math> )</p> <p>3. Q factor change: Within <math>\pm 20\%</math>.</p>	<p>1. Temperature: M(-55~40<math>\pm 2^\circ\text{C}</math>)</p> <p>2. Duration: 96<math>\pm 2</math> hours</p> <p>3. The chip shall be stabilized at normal condition for 1~2 hours before measuring.</p> 

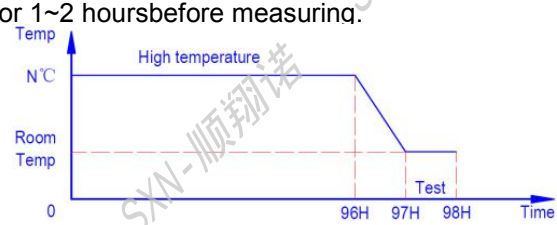
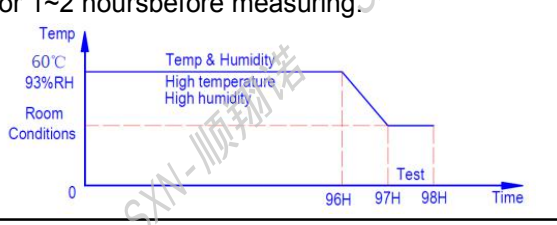
Items	Requirements	Test Methods and Remarks
High temperature Storage Reference documents: GB/T 2423.2-2008 Method Bb 高温储存试验	1.No visible mechanical damage. 2. Inductance change: Within $\pm 10\%$ .(Mn-Zn: Within $\cong 30\%$ ) 3.Q factor change: Within $\pm 20\%$ .	1.Temperature:N( $125\sim 85\pm 2^{\circ}\text{C}$ ). 2.Duration: 96 $\pm 2$ hours 3.The chip shall be stabilized at normal condition for 1~2 hours before measuring. 
Damp Heat (Steady States) Reference documents: GB/T 2423.3-2016 恒定湿热试验	1.No visible mechanical damage. 2. Inductance change: Within $\pm 10\%$ .(Mn-Zn: Within $\cong 30\%$ ) 3. Q factor change: Within $\pm 20\%$ .	1.Temperature: $60\pm 2^{\circ}\text{C}$ 2.Humidity: 90% to 95% RH. 3.Duration: 96 $\pm 2$ hours. 4.The chip shall be stabilized at normal condition for 1~2 hours before measuring. 
Heat endurance of Reflow soldering Reference documents: GJB 360B-2009 回流焊耐热性试验	1.No significant defects in appearance. 2. $\Delta L/L \cong 10\%$ (Mn-Zn: $\Delta L/L \cong 30\%$ ) 3. $\Delta Q/Q \cong 30\%$ (SMD series only) 4. $\Delta DCR/DCR \cong 10\%$	1.Refer to the above reflow curve and go through the reflow for twice. 2.The peak temperature : $260+0/-5^{\circ}\text{C}$
Resistance to solvent test Reference documents: IEC 68-2-45:1993 耐溶剂性试验	No case deformation or change in appearance or obliteration of marking	To dip parts into IPA solvent for $5\pm 0.5$ Min, then drying them at room temp for 5Min, at last , to brushing making 10 times.
Overload test Reference documents: JIS C5311-6.13 过负荷试验	1.During the test no smoke, no peculiar, smell, no fire 2.The characteristic is normal after test	Apply twice as rated current for 5 minutes.
voltage resistance test Reference documents: MIL-STD-202G Method 301 绝缘耐压测试	1.During the test no breakdown 2.The characteristic is normal after test	1. For parts with two coils 2. DC1000V, Current: 1mA, Time: 1Min. 3. Refer to catalogue of specific products

◆推荐无铅波峰焊接曲线:

Lead-free the recommended Wave soldering (DIP-TYP) :

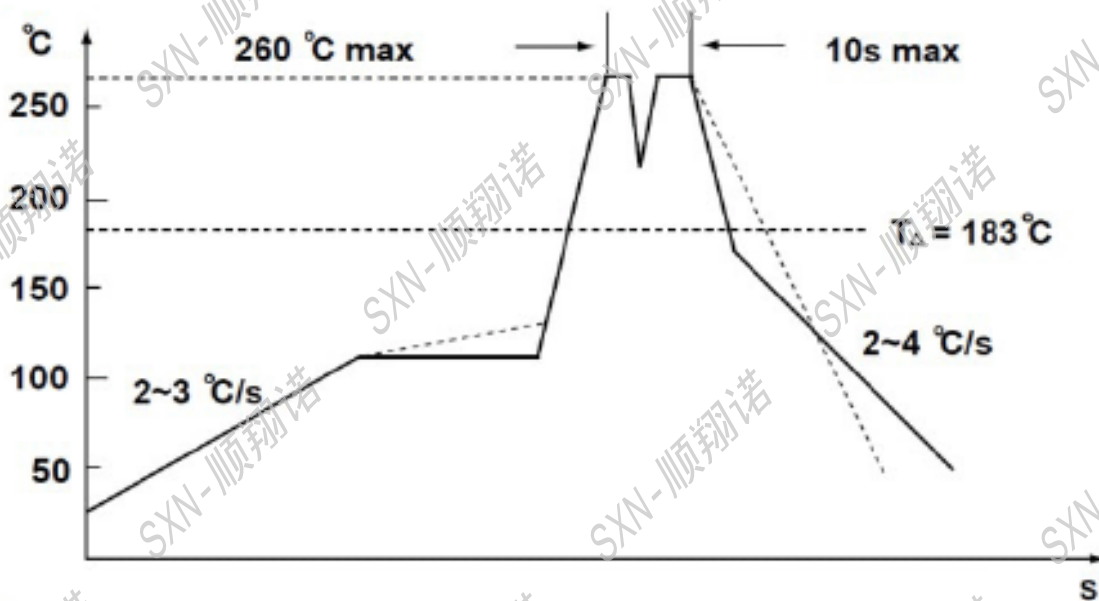

The recommended reflow conditions as above graph, is set according to our soldering equipment. DUE to various manufactures may have different reflow soldering equipment, products, process conditions, set methods. And so on, when setting the reflow conditions, Please adjust and confirm according to users' environment/equipment.

## 使用注意事项

### REMINDERS FOR USING THESE PRODUCTS



- 保存时间为12个月以内，保存条件（温度5~40°C以下、湿度35 ~ 66%RH 以下），需充分注意。若超过保存时间，端子电极的可焊性将可能老化。

The storage period is within 12 months. Be sure to follow the storage conditions (temperature: 5~40°C, humidity: 35 to 65% RH or less). If the storage period elapses, the soldering of the terminal electrodes may deteriorate.

- 请勿在气体腐蚀环境（盐、酸、碱等）下使用和保存。

Do not use or store in locations where there are conditions such as gas corrosion (salt, acid, alkali, etc.).

- 手上的油脂会导致可焊性降低，应避免用手直接接触端子。

Don't touch electrodes directly with bare hands as oil secretions may inhibit soldering. Always ensure optimum conditions for soldering.

- 请小心轻拿轻放，避免由于产品的跌落或取出不当而导致的损坏。

Please always handle products carefully to prevent any damage caused by dropping down or inappropriate removing.

- 端子过度弯曲会导致断线，请不要过度弯曲端子。

Don't bend the terminals with excessive stress in case of any wire fracture.

- 不要清洗产品，如需要清洗时请联系我司。

Don't rinse coils by yourself and please contact SXN if necessary.

- 请勿将本产品靠近磁铁或带有磁力的物体

Don't expose the products to magnets or magnetic fields

- 在实施焊接前，请务必进行预热。预热温度与焊接温度及芯片温度的温度差要在150°C 以内。

Before soldering, be sure to preheat components. The preheating temperature should be set so that the temperature difference between the solder temperature and chip temperature does not exceed 150°C.

- 安装后的焊接修正应在规格书规定的条件范围内。若加热过度可能导致短路、性能降低、寿命减少。

Soldering corrections after mounting should be within the range of the conditions determined in the specifications. If overheated, a short circuit, performance deterioration, or lifespan shortening may occur.

- 装置会因通电而自我发热（温度上升），因此在热设计方面需留有充分余地。

Self heating (temperature increase) occurs when the power is turned ON, so the tolerance should be sufficient for the set thermal design.

- 非磁屏蔽型在基板设计时需注意配置线圈，受到电磁干扰可能会导致误动作。

Carefully lay out the coil for the circuit board design of the non-magnetic shield type. A malfunction may occur due to magnetic interference.

- 当公司产品使用在一般电子设备以外的场合，如：车载、医疗设备、军用、航空航天等，请务必联系本公司营业部门，如超出公司产品使用条件而引起的机器故障时，本公司概不负责。

If SXN product will be applied in area like automotive product, medical equipment, military and aerospace except generalelectronic device, please keep SXN sales informed in advance. SXN shall not be held liable for any malfunction or breakdown caused by using product in the condition which is inconsistent with that recommended by SXN.

## X-ON Electronics

Largest Supplier of Electrical and Electronic Components

*Click to view similar products for [Fixed Inductors](#) category:*

*Click to view products by [SXN](#) manufacturer:*

Other Similar products are found below :

[CR32NP-151KC](#) [CR32NP-180KC](#) [CR32NP-181KC](#) [CR32NP-1R5MC](#) [CR32NP-390KC](#) [CR32NP-3R9MC](#) [CR32NP-680KC](#) [CR32NP-820KC](#) [CR32NP-8R2MC](#) [CR43NP-390KC](#) [CR43NP-560KC](#) [CR43NP-680KC](#) [CR54NP-181KC](#) [CR54NP-470LC](#) [CR54NP-820KC](#) [CR54NP-8R5MC](#) [70F224AI](#) [MGDQ4-00004-P](#) [MHL1ECTTP18NJ](#) [MHQ1005P10NJ](#) [MHQ1005P1N0S](#) [MHQ1005P2N4S](#) [MHQ1005P3N6S](#) [MHQ1005P5N1S](#) [MHQ1005P8N2J](#) [PE-51506NL](#) [PE-53601NL](#) [PE-53602NL](#) [PE-53630NL](#) [PE-53824SNLT](#) [PE-92100NL](#) [PG0434.801NLT](#) [PG0936.113NLT](#) [9220-20](#) [9310-16](#) [PM06-2N7](#) [PM06-39NJ](#) [A01TK](#) [1206CS-471XJ](#) [HC2LP-R47-R](#) [HC2-R47-R](#) [HC3-2R2-R](#) [HCF1305-3R3-R](#) [1206CS-151XG](#) [RCH664NP-140L](#) [RCH664NP-4R7M](#) [RCH8011NP-221L](#) [RCP1317NP-332L](#) [RCP1317NP-391L](#) [RCR1010NP-470M](#)