

Shielded SMD Power Inductors



SMDRI series, Shielded SMD Power Inductors



◆特征:

- 高饱和电流, 低直流电阻
- 闭合磁路设计减少漏磁
- 自动贴装的高精度尺寸
- 多种封装尺寸和宽电感范围
- 符合 RoHS, 无卤和 REACH

Features:

- High saturation current, low DCR
- Close magnetic circuit design reduce leakage
- High accurate dimensions for automatic mounting
- Various package size and wide inductance range
- RoHS, Halogen Free and REACH Compliance

◆用途:

- 录影机
- 液晶电视
- 笔记本电脑
- 小型通信机器.
- DC/DC 转换器等

Applications:

- Power supply for VTRs
- LCD televisions
- Notebook PCs
- Portable communication equipment
- DC/DC converters, etc

◆环境:

- 工作温度: -40°C 至+125°C
(包括线圈自身温升)

Environmental Data:

- Operating Temperature: -40°C to +125°C
(Including coils self-temperature rise)

◆试验设备:

- 电感值: HP4284A, HP4285A 或同等仪器
- 电流: HP4284+42841A
- 品质因子: HP4285A
- 直流电阻: Chroma 16502 或同等仪器

Test Equipment:

- L: HP4284A or HP4285A LCR meter or equivalent
- Isat & Irrms: HP4284+42841A
- Q: HP4285A
- DCR: Chroma 16502 or equivalent

◆产品型号:

Product Identification:

SMDRI

125

470

M

T

①

②

③

④

⑤

①

类型 Type	
SMDRI	闭磁路贴片电感 Shielded SMT Power Inductors 

②

外形尺寸(L×W×H) (mm) External Dimensions (L×W×H) (mm)	
125	12.3×12.3×6.0

③

Inductance
47 uH

④

公差 Inductance Tolerance
J: ±5%, K: ±10%, L: ±15% M: ±20%, P: ±25%, N: ±30%

⑤

包装 Packing	
B	散装 Bulk Package
T	编带 Tape & Reel

◆外观尺寸:

Shape and Dimensions(dimensions are in mm):

Fig.1

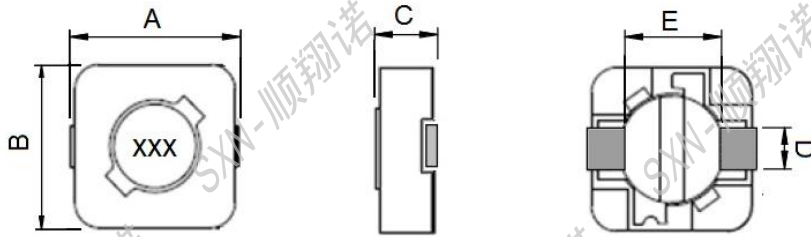

SCHEMATIC

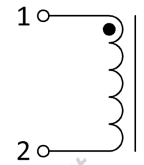
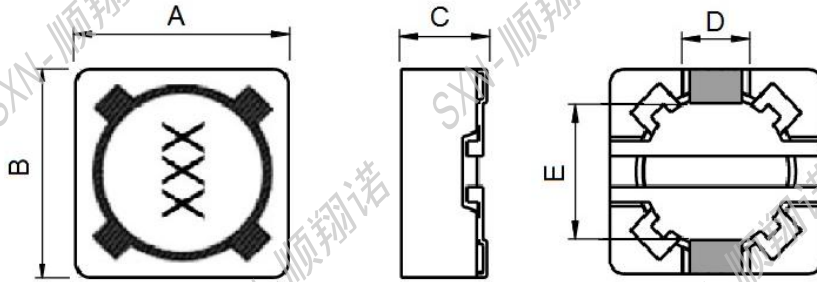

Fig.2



Recommended Land Pattern

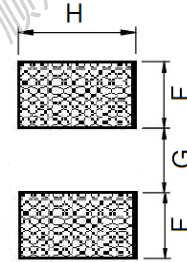
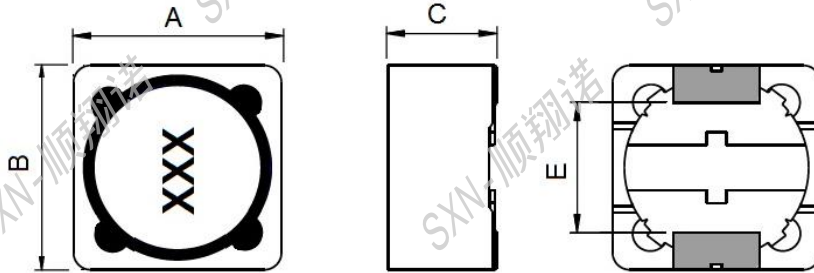

Fig.3



Part No	ITEM								
	Shape	A	B	C	D	E	F	G	H
SMDRI62	Fig.1	6.5 Max	6.8 Max	3.0 Max	4.6	1.5	1.4	4.6	1.9
SMDRI64	Fig.1	6.5 Max	6.8 Max	5.0 Max	4.6	1.5	1.4	4.6	1.9
SMDRI73	Fig.2	7.5 Max	7.5 Max	3.4 Max	5.0	1.8	1.6	4.8	2.2
SMDRI74	Fig.2	7.5 Max	7.5 Max	4.5 Max	5.0	1.8	1.6	4.8	2.2
SMDRI124	Fig.3	12.3 Max	12.3 Max	4.5 Max	7.6	5.0	2.9	7.0	5.4
SMDRI125	Fig.3	12.3 Max	12.3 Max	6.0 Max	7.6	5.0	2.9	7.0	5.4
SMDRI127	Fig.3	12.3 Max	12.3 Max	8.0 Max	7.6	5.0	2.9	7.0	5.4

◆规格特性:

Specifications:

- SMDRI62 Series Electrical Characteristics (Electrical specifications at 25°C)

Part No	Inductance			Quality Factor		DCR	Saturation Current	Temperature Rise Current
	L(μH) '@0A	Tole	Test Freq	Min	Test Freq	(Ω) Max	(A) Max	(A) Max
SMDRI62-3R3N	3.3	N	100KHz	20	1MHz	0.068	2.75	1.94
SMDRI62-4R7N	4.7	N	100KHz	20	1MHz	0.080	1.95	1.63
SMDRI62-5R6N	5.6	N	100KHz	30	1MHz	0.096	1.80	1.40
SMDRI62-100N	10	N	100KHz	35	1MHz	0.150	1.40	1.10
SMDRI62-120M	12	M	100KHz	35	1MHz	0.200	1.25	1.00
SMDRI62-150M	15	M	100KHz	35	1MHz	0.230	1.15	0.90
SMDRI62-180M	18	M	100KHz	35	1MHz	0.270	1.05	0.80
SMDRI62-220M	22	M	100KHz	35	1MHz	0.340	0.95	0.74
SMDRI62-270M	27	M	100KHz	35	1MHz	0.380	0.85	0.66
SMDRI62-330M	33	M	100KHz	35	1MHz	0.450	0.80	0.59
SMDRI62-390M	39	M	100KHz	35	1MHz	0.490	0.65	0.54
SMDRI62-470M	47	M	100KHz	35	1MHz	0.690	0.62	0.50
SMDRI62-560M	56	M	100KHz	35	1MHz	0.780	0.57	0.46
SMDRI62-680M	68	M	100KHz	35	1MHz	1.070	0.52	0.42
SMDRI62-820M	82	M	100KHz	35	1MHz	1.210	0.48	0.38
SMDRI62-101M	100	M	100KHz	40	0.796MHz	1.390	0.43	0.34
SMDRI62-121M	120	M	100KHz	40	0.796MHz	1.900	0.38	0.31
SMDRI62-151M	150	M	100KHz	40	0.796MHz	2.180	0.36	0.28
SMDRI62-181M	180	M	100KHz	40	0.796MHz	2.770	0.32	0.26
SMDRI62-221M	220	M	100KHz	40	0.796MHz	3.120	0.29	0.23
SMDRI62-271M	270	M	100KHz	40	0.796MHz	4.380	0.26	0.22
SMDRI62-331M	330	M	100KHz	40	0.796MHz	4.940	0.23	0.19

- Saturation current VS temperature rise current curve

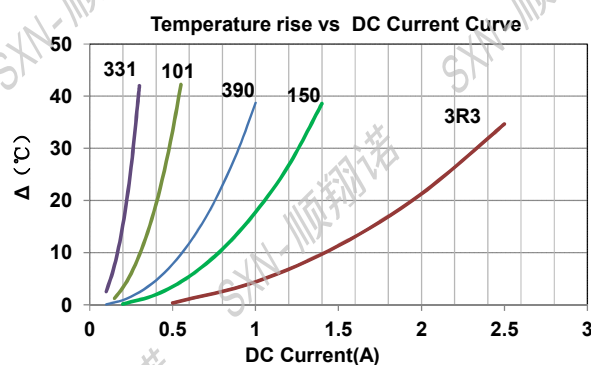
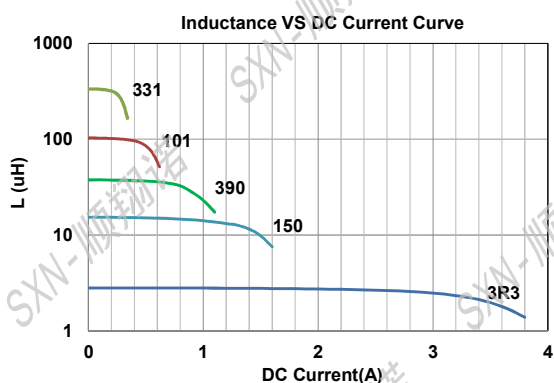

• SMDR164 Series Electrical Characteristics (Electrical specifications at 25°C)

Part No	Inductance			Quality Factor		DCR (Ω) Max	Saturation Current (A) Max	Temperature Rise Current (A) Max
	L(μ H) '@0A	Tole	Test Freq	Min	Test Freq			
SMDR164-100N	10	N	100KHz	35	1MHz	0.12	2.10	1.35
SMDR164-120M	12	M	100KHz	35	1MHz	0.13	1.85	1.22
SMDR164-150M	15	M	100KHz	35	1MHz	0.18	1.55	1.11
SMDR164-180M	18	M	100KHz	35	1MHz	0.24	1.40	1.02
SMDR164-220M	22	M	100KHz	35	1MHz	0.27	1.35	0.91
SMDR164-270M	27	M	100KHz	35	1MHz	0.30	1.20	0.82
SMDR164-330M	33	M	100KHz	35	1MHz	0.33	1.15	0.74
SMDR164-390M	39	M	100KHz	35	1MHz	0.37	1.10	0.69
SMDR164-470M	47	M	100KHz	35	1MHz	0.52	0.90	0.62
SMDR164-560M	56	M	100KHz	35	1MHz	0.56	0.85	0.58
SMDR164-680M	68	M	100KHz	35	1MHz	0.63	0.80	0.51
SMDR164-820M	82	M	100KHz	35	1MHz	0.71	0.68	0.46
SMDR164-101M	100	M	100KHz	40	0.796MHz	1.03	0.64	0.42
SMDR164-121M	120	M	100KHz	40	0.796MHz	1.15	0.60	0.38
SMDR164-151M	150	M	100KHz	40	0.796MHz	1.68	0.56	0.35
SMDR164-181M	180	M	100KHz	40	0.796MHz	1.87	0.50	0.32
SMDR164-221M	220	M	100KHz	40	0.796MHz	2.08	0.42	0.29
SMDR164-271M	270	M	100KHz	40	0.796MHz	2.37	0.38	0.26
SMDR164-331M	330	M	100KHz	40	0.796MHz	2.67	0.35	0.23
SMDR164-391M	390	M	100KHz	40	0.796MHz	2.94	0.32	0.22
SMDR164-471M	470	M	100KHz	40	0.796MHz	3.93	0.29	0.20
SMDR164-561M	560	M	100KHz	40	0.796MHz	5.43	0.27	0.18
SMDR164-681M	680	M	100KHz	40	0.796MHz	7.32	0.25	0.17
SMDR164-821M	820	M	100KHz	40	0.796MHz	8.24	0.22	0.15
SMDR164-102M	1000	M	100KHz	40	0.796MHz	9.26	0.20	0.14

• Saturation current VS temperature rise current curve

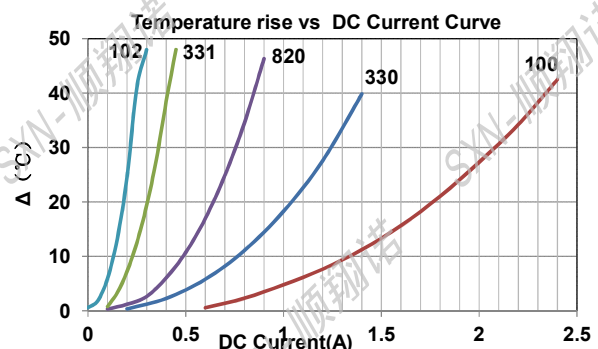
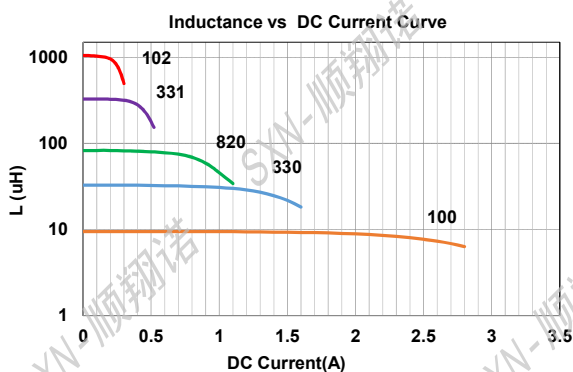

• SMDR173 Series Electrical Characteristics (Electrical specifications at 25°C)

Part No	Inductance			Quality Factor		DCR (Ω) Max	Saturation Current (A) Max	Temperature Rise Current (A) Max
	L(μH) '@0A	Tole	Test Freq	Min	Test Freq			
SMDR173-100N	10	N	100KHz	35	1MHz	0.072	2.10	1.68
SMDR173-120M	12	M	100KHz	35	1MHz	0.098	2.00	1.52
SMDR173-150M	15	M	100KHz	35	1MHz	0.130	1.60	1.33
SMDR173-180M	18	M	100KHz	35	1MHz	0.140	1.55	1.20
SMDR173-220M	22	M	100KHz	35	1MHz	0.190	1.45	1.07
SMDR173-270M	27	M	100KHz	35	1MHz	0.210	1.25	0.96
SMDR173-330M	33	M	100KHz	35	1MHz	0.240	1.20	0.91
SMDR173-390M	39	M	100KHz	35	1MHz	0.320	1.05	0.77
SMDR173-470M	47	M	100KHz	35	1MHz	0.360	0.96	0.76
SMDR173-560M	56	M	100KHz	35	1MHz	0.470	0.92	0.68
SMDR173-680M	68	M	100KHz	35	1MHz	0.520	0.80	0.61
SMDR173-820M	82	M	100KHz	35	1MHz	0.690	0.76	0.57
SMDR173-101M	100	M	100KHz	40	0.796MHz	0.790	0.65	0.50
SMDR173-121M	120	M	100KHz	40	0.796MHz	0.890	0.59	0.49
SMDR173-151M	150	M	100KHz	40	0.796MHz	1.270	0.53	0.43
SMDR173-181M	180	M	100KHz	40	0.796MHz	1.450	0.50	0.39
SMDR173-221M	220	M	100KHz	40	0.796MHz	1.650	0.45	0.35
SMDR173-271M	270	M	100KHz	40	0.796MHz	2.310	0.39	0.32
SMDR173-331M	330	M	100KHz	40	0.796MHz	2.620	0.37	0.28
SMDR173-391M	390	M	100KHz	40	0.796MHz	2.940	0.36	0.26
SMDR173-471M	470	M	100KHz	40	0.796MHz	4.180	0.29	0.24
SMDR173-561M	560	M	100KHz	40	0.796MHz	4.670	0.27	0.22
SMDR173-681M	680	M	100KHz	40	0.796MHz	5.730	0.25	0.19
SMDR173-821M	820	M	100KHz	40	0.796MHz	6.540	0.23	0.18
SMDR173-102M	1000	M	100KHz	40	0.796MHz	9.440	0.22	0.16

• Saturation current VS temperature rise current curve

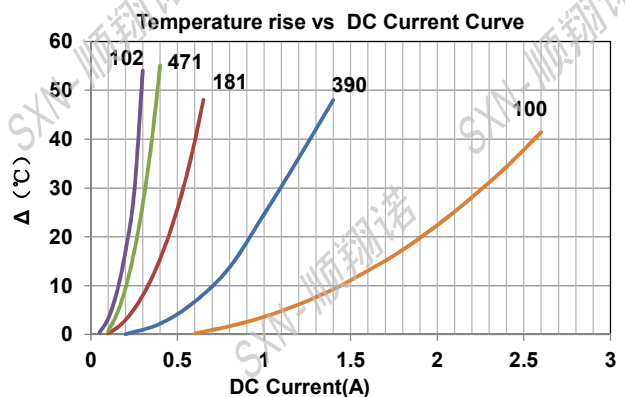
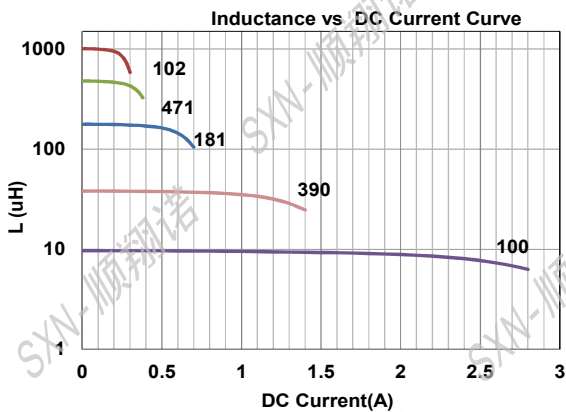

● SMDR174 Series Electrical Characteristics (Electrical specifications at 25°C)

Part No	Inductance			Quality Factor		DCR	Saturation Current	Temperature Rise Current
	L(μH) '@0A	Tole	Test Freq	Min	Test Freq	(Ω) Max	(A) Max	(A) Max
SMDR174-2R2N	2.2	N	100KHz	30	1MHz	0.0147	5.20	5.00
SMDR174-3R3N	3.3	N	100KHz	30	1MHz	0.0214	4.60	4.00
SMDR174-4R7N	4.7	N	100KHz	30	1MHz	0.0310	3.80	3.40
SMDR174-6R8N	6.8	N	100KHz	30	1MHz	0.035	3.20	2.30
SMDR174-8R2N	8.2	N	100KHz	30	1MHz	0.042	3.00	2.10
SMDR174-100N	10	N	100KHz	35	1MHz	0.049	2.95	1.84
SMDR174-120M	12	M	100KHz	35	1MHz	0.058	2.85	1.71
SMDR174-150M	15	M	100KHz	35	1MHz	0.081	2.80	1.47
SMDR174-180M	18	M	100KHz	35	1MHz	0.091	2.50	1.31
SMDR174-220M	22	M	100KHz	35	1MHz	0.110	2.10	1.23
SMDR174-270M	27	M	100KHz	35	1MHz	0.150	1.90	1.12
SMDR174-330M	33	M	100KHz	35	1MHz	0.170	1.80	0.96
SMDR174-390M	39	M	100KHz	35	1MHz	0.230	1.70	0.91
SMDR174-470M	47	M	100KHz	35	1MHz	0.260	1.50	0.88
SMDR174-560M	56	M	100KHz	35	1MHz	0.350	1.32	0.75
SMDR174-680M	68	M	100KHz	35	1MHz	0.380	1.08	0.69
SMDR174-820M	82	M	100KHz	35	1MHz	0.430	1.05	0.61
SMDR174-101M	100	M	100KHz	40	0.796MHz	0.610	1.02	0.60
SMDR174-121M	120	M	100KHz	40	0.796MHz	0.660	0.98	0.52
SMDR174-151M	150	M	100KHz	40	0.796MHz	0.880	0.95	0.46
SMDR174-181M	180	M	100KHz	40	0.796MHz	0.980	0.74	0.42
SMDR174-221M	220	M	100KHz	40	0.796MHz	1.170	0.70	0.36
SMDR174-271M	270	M	100KHz	40	0.796MHz	1.640	0.57	0.34
SMDR174-331M	330	M	100KHz	40	0.796MHz	1.860	0.56	0.32
SMDR174-391M	390	M	100KHz	40	0.796MHz	2.850	0.45	0.29
SMDR174-471M	470	M	100KHz	40	0.796MHz	3.010	0.45	0.26
SMDR174-561M	560	M	100KHz	40	0.796MHz	3.620	0.43	0.23
SMDR174-681M	680	M	100KHz	40	0.796MHz	4.630	0.37	0.22
SMDR174-821M	820	M	100KHz	40	0.796MHz	5.200	0.35	0.20
SMDR174-102M	1000	M	100KHz	40	0.796MHz	6.000	0.33	0.18

● Saturation current VS temperature rise current curve

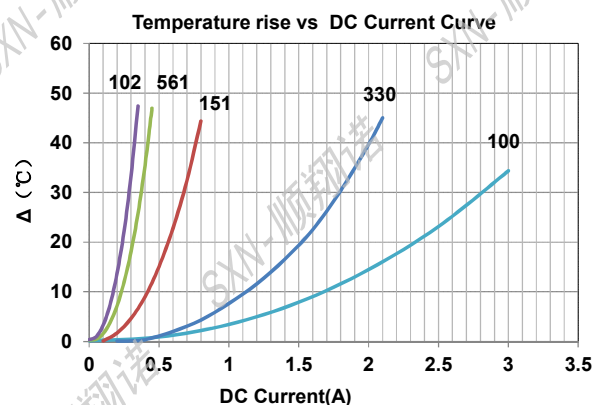
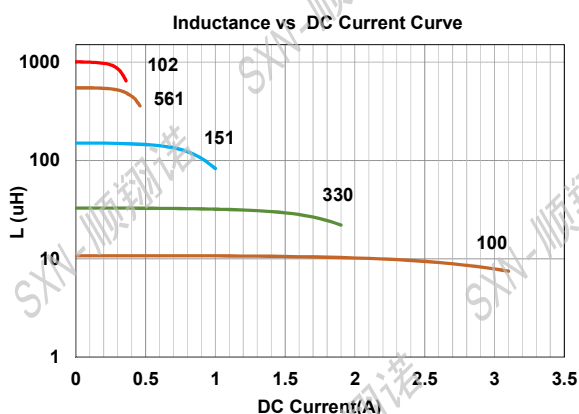

• SMDR124 Series Electrical Characteristics (Electrical specifications at 25°C)

Part No	Inductance			Quality Factor		DCR	Saturation Current	Temperature Rise Current
	L(μH) '@0A	Tole	Test Freq	Min	Test Freq	(Ω) Max	(A) Max	(A) Max
SMDR124-1R0N	1.0	N	100KHz	20	1MHz	0.010	12.00	7.0
SMDR124-2R2N	2.2	N	100KHz	20	1MHz	0.014	11.50	5.7
SMDR124-3R3N	3.3	N	100KHz	30	1MHz	0.015	11.00	5.2
SMDR124-3R9N	3.9	N	100KHz	30	1MHz	0.015	10.50	6.5
SMDR124-4R7N	4.7	N	100KHz	30	1MHz	0.018	9.70	4.9
SMDR124-6R8N	6.8	N	100KHz	30	1MHz	0.023	7.10	4.2
SMDR124-8R2N	8.2	N	100KHz	30	1MHz	0.026	6.50	4.0
SMDR124-100N	10	N	100KHz	35	1MHz	0.028	6.00	3.8
SMDR124-120M	12	M	100KHz	35	1MHz	0.038	5.70	3.5
SMDR124-150M	15	M	100KHz	35	1MHz	0.050	5.40	3.2
SMDR124-180M	18	M	100KHz	35	1MHz	0.057	5.20	3.1
SMDR124-220M	22	M	100KHz	35	1MHz	0.066	4.40	2.9
SMDR124-270M	27	M	100KHz	35	1MHz	0.080	3.80	2.8
SMDR124-330M	33	M	100KHz	35	1MHz	0.097	3.40	2.7
SMDR124-390M	39	M	100KHz	35	1MHz	0.132	3.30	2.1
SMDR124-470M	47	M	100KHz	35	1MHz	0.150	3.00	1.9
SMDR124-560M	56	M	100KHz	35	1MHz	0.190	2.70	1.8
SMDR124-680M	68	M	100KHz	35	1MHz	0.220	2.50	1.5
SMDR124-820M	82	M	100KHz	35	1MHz	0.260	2.40	1.3
SMDR124-101M	100	M	100KHz	40	0.796MHz	0.308	2.20	1.2
SMDR124-121M	120	M	100KHz	40	0.796MHz	0.380	1.95	1.1
SMDR124-151M	150	M	100KHz	40	0.796MHz	0.530	1.70	0.95
SMDR124-181M	180	M	100KHz	40	0.796MHz	0.620	1.59	0.85
SMDR124-221M	220	M	100KHz	40	0.796MHz	0.700	1.39	0.8
SMDR124-271M	270	M	100KHz	40	0.796MHz	0.876	1.20	0.6
SMDR124-331M	330	M	100KHz	40	0.796MHz	0.990	1.00	0.5

• Saturation current VS temperature rise current curve

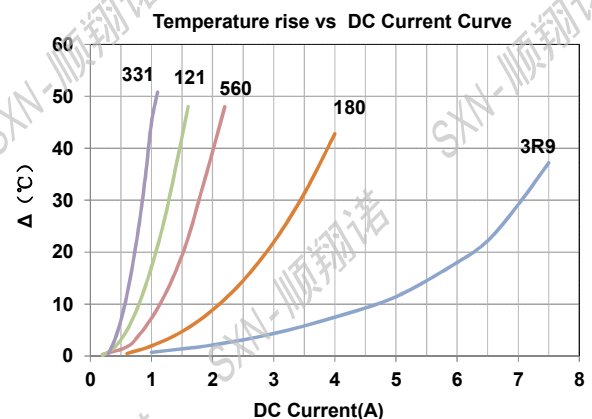
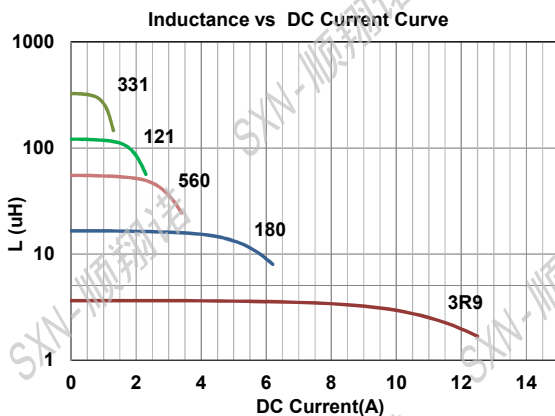

● SMDR125 Series Electrical Characteristics (Electrical specifications at 25°C)

Part No	Inductance			Quality Factor		DCR (Ω) Max	Saturation Current (A) Max	Temperature Rise Current (A) Max
	L(μ H) '@0A	Tole	Test Freq	Min	Test Freq			
SMDR125-1R0N	1.0	N	100KHz	20	1MHz	0.010	15.80	8.00
SMDR125-2R2N	2.2	N	100KHz	20	1MHz	0.014	13.50	7.80
SMDR125-2R4N	2.4	N	100KHz	20	1MHz	0.014	12.00	7.50
SMDR125-3R3N	3.3	N	100KHz	20	1MHz	0.017	10.50	6.80
SMDR125-4R7N	4.7	N	100KHz	30	1MHz	0.020	9.50	5.60
SMDR125-5R8N	5.8	N	100KHz	30	1MHz	0.021	8.60	5.20
SMDR125-8R2N	8.2	N	100KHz	30	1MHz	0.023	7.00	4.40
SMDR125-100N	10	N	100KHz	35	1MHz	0.025	6.50	4.00
SMDR125-120M	12	M	100KHz	35	1MHz	0.027	6.00	3.50
SMDR125-150M	15	M	100KHz	35	1MHz	0.030	5.40	3.30
SMDR125-180M	18	M	100KHz	35	1MHz	0.034	4.90	3.00
SMDR125-220M	22	M	100KHz	35	1MHz	0.036	4.70	2.80
SMDR125-270M	27	M	100KHz	35	1MHz	0.051	4.00	2.30
SMDR125-330M	33	M	100KHz	35	1MHz	0.057	3.58	2.10
SMDR125-390M	39	M	100KHz	35	1MHz	0.068	3.30	2.00
SMDR125-470M	47	M	100KHz	35	1MHz	0.075	3.20	1.80
SMDR125-560M	56	M	100KHz	35	1MHz	0.110	2.80	1.70
SMDR125-680M	68	M	100KHz	35	1MHz	0.120	2.50	1.50
SMDR125-820M	82	M	100KHz	35	1MHz	0.140	2.30	1.40
SMDR125-101M	100	M	100KHz	40	0.796MHz	0.160	1.90	1.30
SMDR125-121M	120	M	100KHz	40	0.796MHz	0.170	1.80	1.10
SMDR125-151M	150	M	100KHz	40	0.796MHz	0.230	1.70	1.00
SMDR125-181M	180	M	100KHz	40	0.796MHz	0.290	1.60	0.90
SMDR125-221M	220	M	100KHz	40	0.796MHz	0.400	1.45	0.80
SMDR125-271M	270	M	100KHz	40	0.796MHz	0.460	1.20	0.75
SMDR125-331M	330	M	100KHz	40	0.796MHz	0.510	1.15	0.68
SMDR125-391M	390	M	100KHz	40	0.796MHz	0.690	1.10	0.65
SMDR125-471M	470	M	100KHz	40	0.796MHz	0.770	0.94	0.58
SMDR125-561M	560	M	100KHz	40	0.796MHz	0.860	0.90	0.54
SMDR125-681M	680	M	100KHz	40	0.796MHz	1.200	0.37	0.48
SMDR125-821M	820	M	100KHz	40	0.796MHz	1.340	0.35	0.43
SMDR125-102M	1000	M	100KHz	40	0.796MHz	1.530	0.30	0.40

● Saturation current VS temperature rise current curve

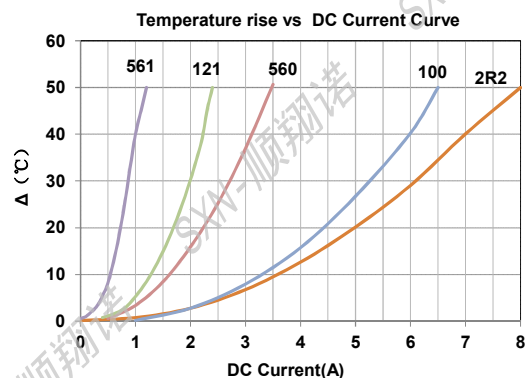
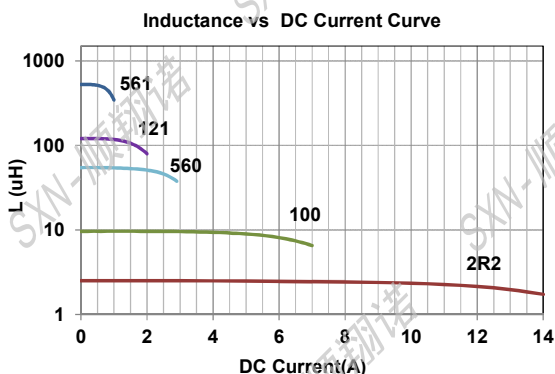

• SMDR127 Series Electrical Characteristics (Electrical specifications at 25°C)

Part No	Inductance			Quality Factor		DCR (Ω) Max	Saturation Current (A) Max	Temperature Rise Current (A) Max
	L(μ H) '@0A	Tole	Test Freq	Min	Test Freq			
SMDR127-1R0N	1.0	N	100KHz	20	1MHz	0.009	26.00	10.00
SMDR127-2R2N	2.2	N	100KHz	20	1MHz	0.012	21.00	8.00
SMDR127-2R7N	2.7	N	100KHz	20	1MHz	0.013	19.00	8.00
SMDR127-3R3N	3.3	N	100KHz	20	1MHz	0.013	16.00	8.00
SMDR127-3R9N	3.9	N	100KHz	20	1MHz	0.013	14.00	7.50
SMDR1274R7N	4.7	N	100KHz	30	1MHz	0.016	12.00	6.80
SMDR127-6R1N	6.1	N	100KHz	30	1MHz	0.018	11.50	6.60
SMDR127-6R8N	6.8	N	100KHz	30	1MHz	0.019	10.50	6.60
SMDR127-7R6N	7.6	N	100KHz	30	1MHz	0.020	10.00	5.90
SMDR127-8R2N	8.2	N	100KHz	30	1MHz	0.020	9.50	5.60
SMDR127-100N	10	N	100KHz	35	1MHz	0.021	9.00	5.40
SMDR127-120M	12	M	100KHz	35	1MHz	0.240	8.50	4.90
SMDR127-150M	15	M	100KHz	35	1MHz	0.027	8.00	4.50
SMDR127-180M	18	M	100KHz	35	1MHz	0.039	7.50	3.90
SMDR127-220M	22	M	100KHz	35	1MHz	0.043	7.00	3.60
SMDR127-270M	27	M	100KHz	35	1MHz	0.046	6.50	3.40
SMDR127-330M	33	M	100KHz	35	1MHz	0.065	5.50	3.00
SMDR127-390M	39	M	100KHz	35	1MHz	0.072	5.00	2.75
SMDR127-470M	47	M	100KHz	35	1MHz	0.100	4.60	2.50
SMDR127-560M	56	M	100KHz	35	1MHz	0.110	4.40	2.35
SMDR127-680M	68	M	100KHz	35	1MHz	0.140	4.00	2.10
SMDR127-820M	82	M	100KHz	35	1MHz	0.160	3.80	1.95
SMDR127-101M	100	M	100KHz	40	0.796MHz	0.220	3.50	1.70
SMDR127-121M	120	M	100KHz	40	0.796MHz	0.250	3.00	1.60
SMDR127-151M	150	M	100KHz	40	0.796MHz	0.280	2.70	1.42
SMDR127-181M	180	M	100KHz	40	0.796MHz	0.350	2.50	1.30
SMDR127-221M	220	M	100KHz	40	0.796MHz	0.390	2.00	1.16
SMDR127-271M	270	M	100KHz	40	0.796MHz	0.560	1.95	1.06
SMDR127-331M	330	M	100KHz	40	0.796MHz	0.640	1.90	0.95
SMDR127-391M	390	M	100KHz	40	0.796MHz	0.700	1.65	0.88
SMDR127-471M	470	M	100KHz	40	0.796MHz	0.980	1.50	0.79
SMDR127-561M	560	M	100KHz	40	0.796MHz	1.070	1.40	0.73
SMDR127-681M	680	M	100KHz	40	0.796MHz	1.460	1.30	0.67
SMDR127-821M	820	M	100KHz	40	0.796MHz	1.640	1.10	0.60
SMDR127-102M	1000	M	100KHz	40	0.796MHz	1.820	1.00	0.55

- Saturation current VS temperature rise current curve

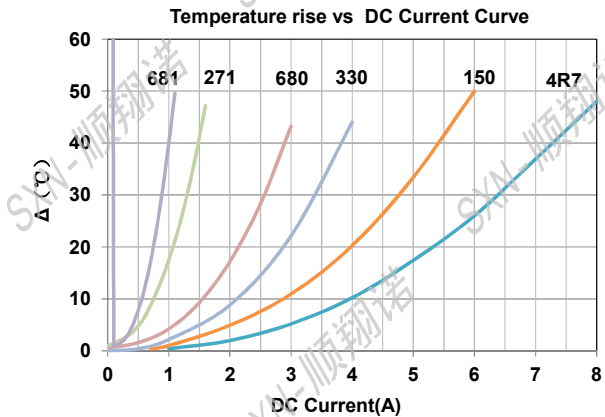
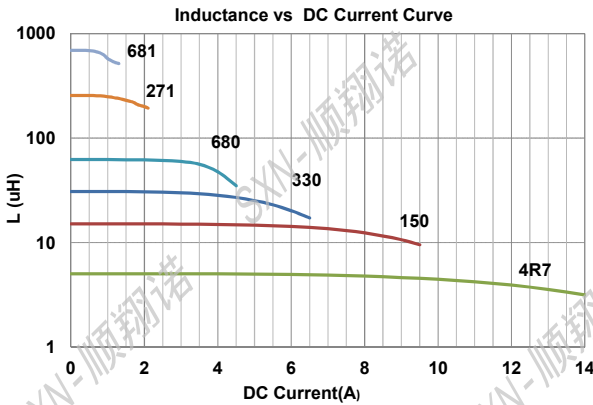

- Saturation Current: DC current at which inductance drops 25% from its value without current.
- Temperature Rise Current: the actual value of DC current when the temperature rise is $\Delta T 40^{\circ}\text{C}$ ($T_a=25^{\circ}\text{C}$).
- Rated DC Current: The less value which is Isat or Irms.
- Special remind: Circuit design, component, PCB trace size and thickness, airflow and other cooling provisions all affect the part temperature. Part temperature should be verified in the end application.

◆ 产品包装:

Packaging:

● Tape and Reel Specifications: (Dimensions are in mm)

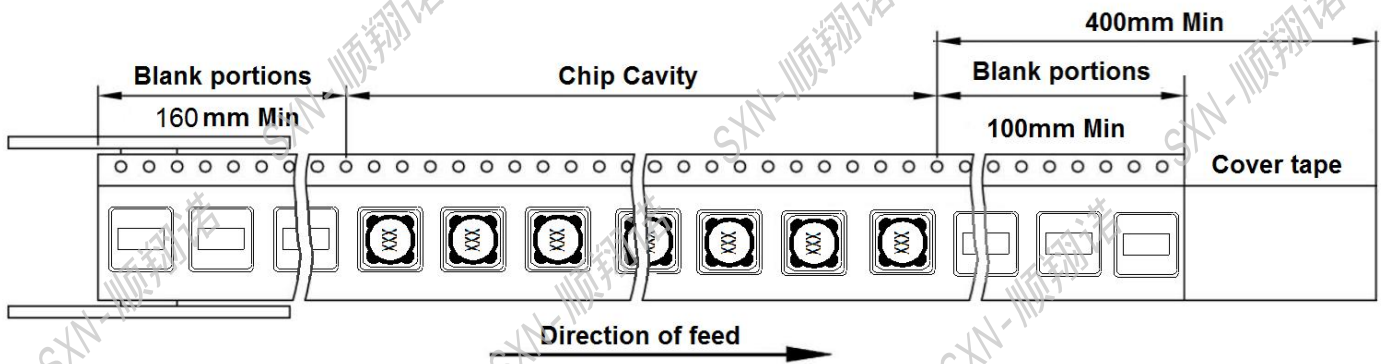

● Reel Dimensions (mm)

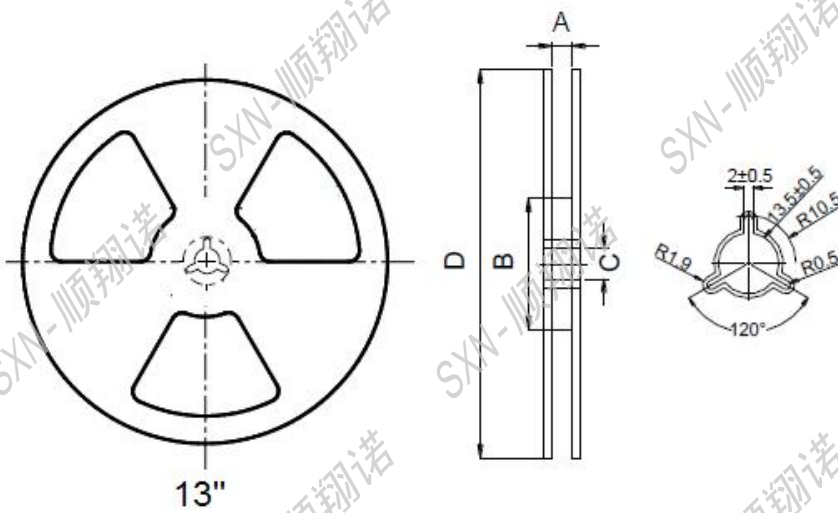

● Tape Dimension (mm)

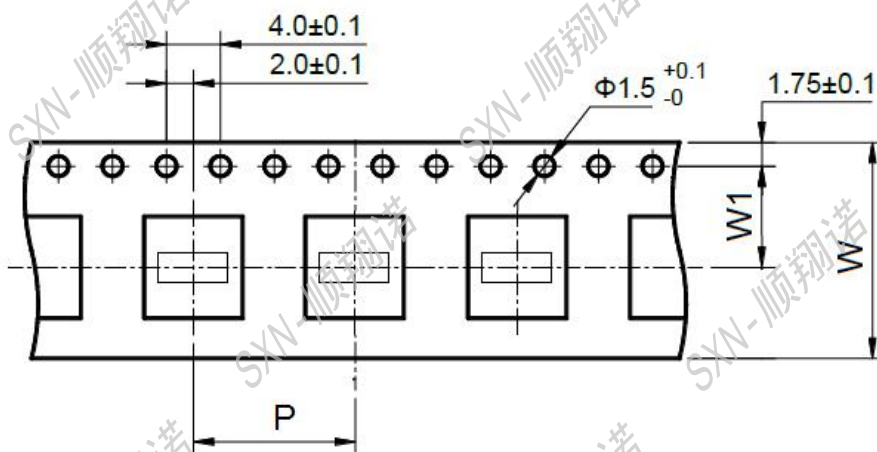

• Cover tape peel off condition

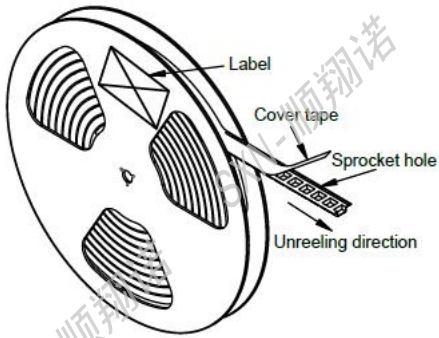

a) Cover tape peel force shall be 10 to 120g

b) Noodle strip peeling angle 165° to 180°

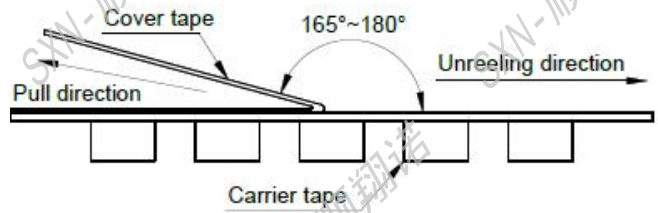

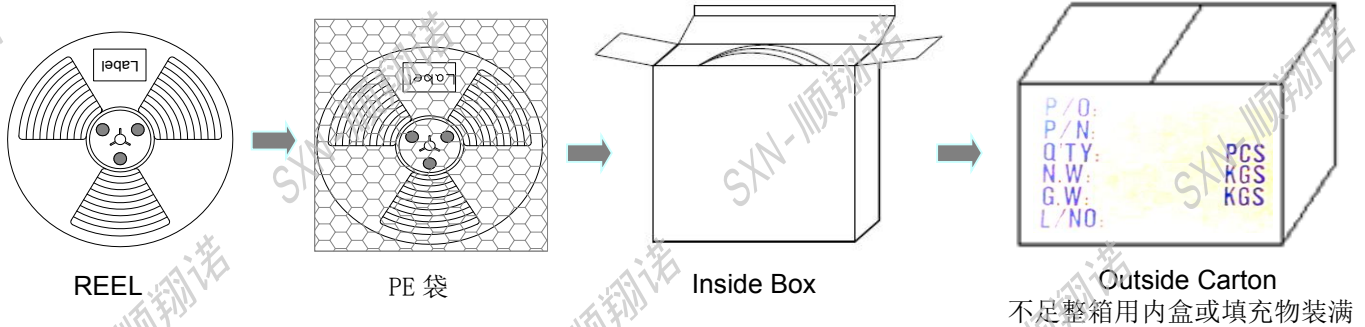

• Packing quantity



Part No.	Tape Dimension			Reel Dimensions				REEL (PCS)	Inside Box(PCS)	Outside Carton(PCS)
	W	P	H	A	B	C	D			
SMDRI62	16	12	11.5	16.5	60	13	330	1500	6000	24,000
SMDRI64	16	12	11.5	16.5	60	13	330	1000	4000	16,000
SMDRI73	16	12	11.5	16.5	60	13	330	1000	3000	12,000
SMDRI74	16	12	11.5	16.5	60	13	330	1000	3000	12,000
SMDRI124	24	16	11.5	24.4	60	13	330	500	1000	4000
SMDRI125	24	16	11.5	24.4	60	13	330	500	1000	4000
SMDRI127	24	16	11.5	24.4	60	13	330	500	1000	4000

◆可靠性测试:

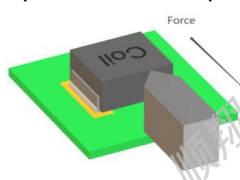
Reliability Testing:

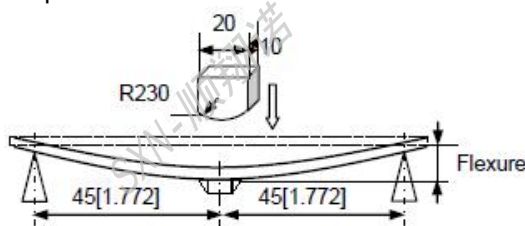
Items	Requirements	Test Methods and Remarks
Terminal Strength Reference documents: GB/T 2423.60-2008 端子強度(SMT)	1. Pulling test: Define: A: sectional area of terminal $A \leq 8\text{mm}^2$ force $\geq 5\text{N}$ time: 30sec $8\text{mm}^2 < A \leq 20\text{mm}^2$ force $\geq 10\text{N}$ time: 10sec $20\text{mm}^2 < A$ force $\geq 20\text{N}$ time: 10sec 2. Solder paste thickness: 0.12mm 3. Meet the above requirements without any loose terminal	Solder the inductor to the testing jig using leadfree solder. Then apply a force in the Keep time: $10 \pm 1\text{s}$ Speed: 1.0mm/s. 
Terminal Strength Reference documents: GB/T 2423.60-2008 端子強度(DIP)	1. Terminal diameter (d) mm $0.35 < d \leq 0.50$ Applied force: 5N Duration: 10sec 2. Terminal diameter (d) mm $0.50 < d \leq 0.80$ Applied force: 10N Duration: 10sec 3. Terminal diameter (d) mm $0.80 < d \leq 1.25$ Applied force: 20N Duration: 10sec 4. Terminal diameter (d) mm $D > 1.25$ Applied force: 40N Duration: 10sec 5. Meet the above requirements without any loose terminal.	Pull Force: the force shall be applied gradually to the terminal and then maintained for 10 seconds. 
Resistance to Flexure JIS C 5321:1997 抗弯曲性试验	1. No visible mechanical damage.	1. Solder the inductor to the test jig (glass epoxy board) 2. shown in Using a leadfree solder. Then apply a force in the direction shown 3. Flexure: 2mm. 4. Pressurizing Speed: 0.5mm/sec. 5. Keep time: 30 sec. 
Dropping Reference documents: GB/T 2423.7-2018 落下試驗	1. No case deformation or change in appearance. 2. No short and no open.	1. Drop the packaged products from 1m high in 1 angle, 3 ridges and 6 surfaces, twice in each direction.
Solderability Reference documents: GB/T 2423.28-2005 可焊性试验	1. No visible mechanical damage. 2. Wetting shall exceed 75% coverage for 3. Terminals must have 95% minimum solder coverage	1. Solder temperature: $240 \pm 2^\circ\text{C}$ 2. Duration: 3 sec. 3. Solder: Sn/3.0Ag/0.5Cu. 4. Flux: 25% Resin and 75% ethanol in weight

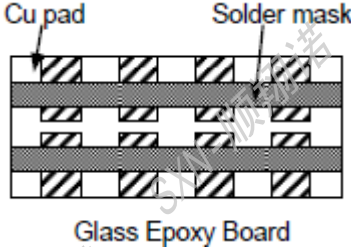
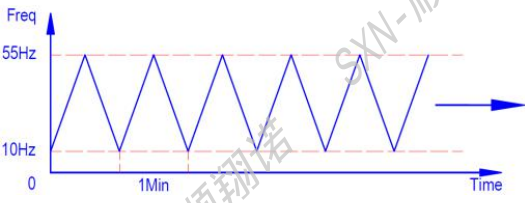
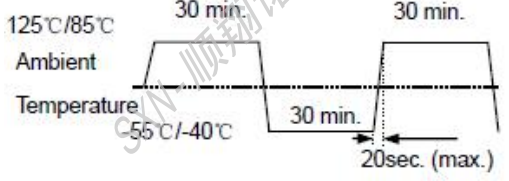
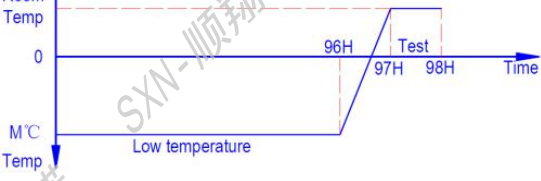
Items	Requirements	Test Methods and Remarks
<p>Vibration</p> <p>Reference documents: GB/T 2423.10-2019</p> <p>振動試驗</p>	<p>1.No visible mechanical damage.</p> <p>2. Inductance change: Within $\pm 10\%$.</p> <p>3. Q factor change: Within $\pm 20\%$.</p> 	<p>1.Solder the inductor to the testing jig (glass epoxy boardshown in) using leadfree solder.</p> <p>2.The inductor shall be subjected to a simple harmonic motion having total amplitude of 1.5mm, the frequency being varied uniformly between the approximate limits of 10 and 55 Hz.</p> <p>3.The frequency range from 10 to 55 Hz and return to 10 Hz shall be traversed in approximately 1 minute. This motion shall be applied for a period of 2 hours in each 3mutually perpendicular directions(total of 6 hours).</p> 
<p>Thermal Shock</p> <p>Reference documents: GB/T 2423.22-2012</p> <p>Method Na</p> <p>冷热冲击试验</p>	<p>1.No visible mechanical damage.</p> <p>2. Inductance change: Within $\pm 10\%$.(Mn-Zn: Within $\leq 30\%$)</p> <p>3.Q factor change: Within $\pm 20\%$.</p>	<p>1.Start at (85~125°C) for T time, rush to (-55~-40°C) for T time as one cycle, go through 100 cycles.</p> <p>2.Transforming interval: Max. 20 sec.</p> <p>3.Tested cycle: 100 cycles.</p> <p>4.The chip shall be stabilized at normal condition for 1~2 hours</p> 
<p>Low temperature Storage</p> <p>Reference documents: GB/T 2423.1-2008</p> <p>Method Ab</p> <p>低温儲存試驗</p>	<p>1.No visible mechanical damage.</p> <p>2. Inductance change: Within $\pm 10\%$.(Mn-Zn: Within $\leq 30\%$)</p> <p>3.Q factor change: Within $\pm 20\%$.</p>	<p>1.Temperature:M(-55~-40$\pm 2^\circ\text{C}$)</p> <p>2.Duration: 96± 2 hours</p> <p>3.The chip shall be stabilized at normal condition for 1~2 hoursbefore measuring.</p> 

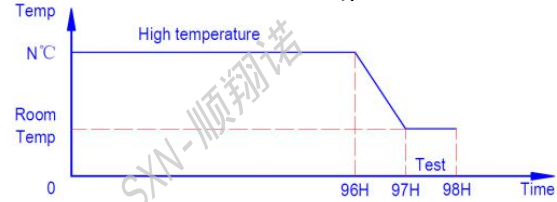
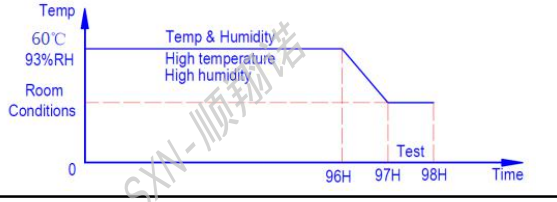
Items	Requirements	Test Methods and Remarks
High temperature Storage Reference documents: GB/T 2423.2-2008 Method Bb 高温储存试验	1.No visible mechanical damage. 2. Inductance change: Within $\pm 10\%$.(Mn-Zn: Within $\cong 30\%$) 3.Q factor change: Within $\pm 20\%$.	1.Temperature:N($125\sim 85\pm 2^{\circ}\text{C}$). 2.Duration: 96 ± 2 hours 3.The chip shall be stabilized at normal condition for 1~2 hours before measuring. 
Damp Heat (Steady States) Reference documents: GB/T 2423.3-2016 恒定湿热试验	1.No visible mechanical damage. 2. Inductance change: Within $\pm 10\%$.(Mn-Zn: Within $\cong 30\%$) 3.Q factor change: Within $\pm 20\%$.	1.Temperature: $60\pm 2^{\circ}\text{C}$ 2.Humidity: 90% to 95% RH. 3.Duration: 96 ± 2 hours. 4.The chip shall be stabilized at normal condition for 1~2 hours before measuring. 
Heat endurance of Reflow soldering Reference documents: GJB 360B-2009 回流焊耐热性试验	1.No significant defects in appearance. 2. $\Delta L/L \cong 10\%$ (Mn-Zn: $\Delta L/L \cong 30\%$) 3. $\Delta Q/Q \cong 30\%$ (SMD series only) 4. $\Delta DCR/DCR \cong 10\%$	1.Refer to the above reflow curve and go through the reflow for twice. 2.The peak temperature : $260\pm 0/-5^{\circ}\text{C}$
Resistance to solvent test Reference documents: IEC 68-2-45:1993 耐溶剂性试验	No case deformation or change in appearance or obliteration of marking	To dip parts into IPA solvent for 5 ± 0.5 Min, then drying them at room temp for 5Min, at last, to brushing making 10 times.
Overload test Reference documents: JIS C5311-6.13 过负荷试验	1.During the test no smoke, no peculiar, smell, no fire 2.The characteristic is normal after test	Apply twice as rated current for 5 minutes.
voltage resistance test Reference documents: MIL-STD-202G Method 301 绝缘耐压测试	1.During the test no breakdown 2.The characteristic is normal after test	1. For parts with two coils 2. DC1000V, Current: 1mA, Time: 1Min. 3. Refer to catalogue of specific products

◆ 推荐回流焊温度曲线

Recommended reflow soldering curve:

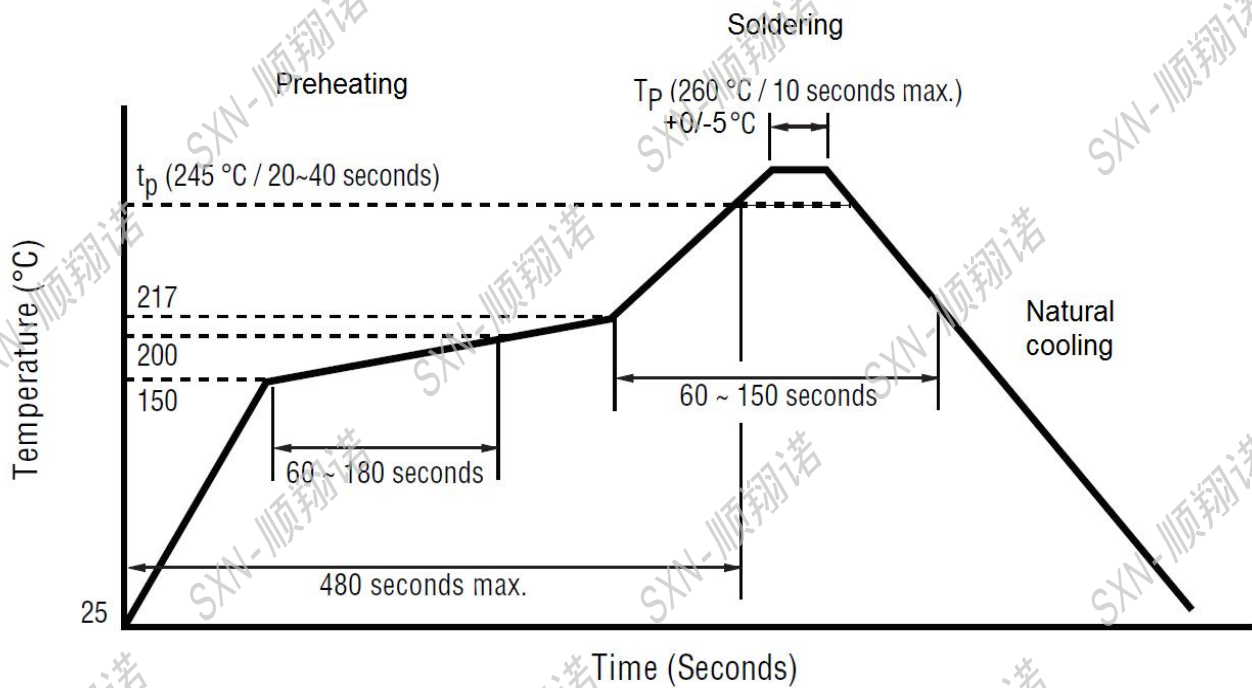

The recommended reflow conditions as above graph, is set according to our soldering equipment. DUE to various manufactures may have different reflow soldering equipment, products, process conditions, set methods. And so on, when setting the reflow conditions, Please adjust and confirm according to users' environment/equipment.

使用注意事项

REMINDERS FOR USING THESE PRODUCTS



- 保存时间为12 个月以内，保存条件（温度5~40°C以下、湿度35 ~ 66%RH 以下），需充分注意。若超过保存时间，端子电极的可焊性将可能老化。

The storage period is within 12 months. Be sure to follow the storage conditions (temperature: 5~40°C, humidity: 35 to 65% RH or less). If the storage period elapses, the soldering of the terminal electrodes may deteriorate.

- 请勿在气体腐蚀环境（盐、酸、碱等）下使用和保存。

Do not use or store in locations where there are conditions such as gas corrosion (salt, acid, alkali, etc.).

- 手上的油脂会导致可焊性降低，应避免用手直接接触端子。

Don't touch electrodes directly with bare hands as oil secretions may inhibit soldering. Always ensure optimum conditions for soldering.

- 请小心轻拿轻放，避免由于产品的跌落或取出不当而导致的损坏。

Please always handle products carefully to prevent any damage caused by dropping down or inappropriate removing.

- 端子过度弯曲会导致断线，请不要过度弯曲端子。

Don't bend the terminals with excessive stress in case of any wire fracture.

- 不要清洗产品，如需要清洗时请联系我司。

Don't rinse coils by yourself and please contact SXN if necessary.

- 请勿将本产品靠近磁铁或带有磁力的物体

Don't expose the products to magnets or magnetic fields

- 在实施焊接前，请务必进行预热。预热温度与焊接温度及芯片温度的温度差要在150°C 以内。

Before soldering, be sure to preheat components. The preheating temperature should be set so that the temperature difference between the solder temperature and chip temperature does not exceed 150°C.

- 安装后的焊接修正应在规格书规定的条件范围内。若加热过度可能导致短路、性能降低、寿命减少。

Soldering corrections after mounting should be within the range of the conditions determined in the specifications. If overheated, a short circuit, performance deterioration, or lifespan shortening may occur.

- 装置会因通电而自我发热（温度上升），因此在热设计方面需留有充分余地。

Self heating (temperature increase) occurs when the power is turned ON, so the tolerance should be sufficient for the set thermal design.

- 非磁屏蔽型在基板设计时需注意配置线圈，受到电磁干扰可能会导致误动作。

Carefully lay out the coil for the circuit board design of the non-magnetic shield type. A malfunction may occur due to magnetic interference.

- 当本公司产品使用在一般电子设备以外的场合，如：车载、医疗设备、军用、航空航天等，请务必联系本公司营业部门，如超出本公司产品使用条件而引起的机器故障时，本公司概不负责。

If SXN product will be applied in area like automotive product, medical equipment, military and aerospace except generalelectronic device, please keep SXN sales informed in advance. SXN shall not be held liable for any malfunction or breakdown caused by using product in the condition which is inconsistent with that recommended by SXN.

X-ON Electronics

Largest Supplier of Electrical and Electronic Components

Click to view similar products for [Fixed Inductors](#) category:

Click to view products by [SXN](#) manufacturer:

Other Similar products are found below :

[CR32NP-100KC](#) [70F224AI](#) [MHQ1005P10NJ](#) [MHQ1005P1N0S](#) [MHQ1005P2N4S](#) [MHQ1005P3N6S](#) [MHQ1005P5N1S](#) [MHQ1005P8N2J](#)
[PE-53601NL](#) [PE-53602NL](#) [PG0936.113NLT](#) [9220-20](#) [9310-16](#) [PM06-2N7](#) [PM06-39NJ](#) [A01TK](#) [1206CS-471XJ](#) [HC2-R47-R](#) [HC8-1R2-R](#)
[HCF1305-3R3-R](#) [1206CS-151XG](#) [RCH664NP-4R7M](#) [RCP1317NP-391L](#) [DH2280-4R7M](#) [DS1608C-106](#) [B10TJ](#) [B82498B3101J000](#) [ELJ-](#)
[RE27NJF2](#) [1812CS-153XJ](#) [1812CS-183XJ](#) [1812CS-223XJ](#) [1812LS-104XJ](#) [1812LS-105XJ](#) [1812LS-124XJ](#) [1812LS-154XJ](#) [1812LS-223XJ](#)
[1812LS-224XJ](#) [1812LS-563XJ](#) [1812LS-683XJ](#) [1812LS-824XJ](#) [NIN-FB101JTR110F](#) [NIN-FB471JTR62F](#) [NIN-FC1R5JTR220F](#) [NIN-](#)
[HCR15JTRF](#) [NIN-HCR33JTRF](#) [NIN-HDR22JTRF](#) [NIN-HDR82JTRF](#) [NIN-HK2N7STRF](#) [NIN-PA150KTR370F](#) [NIN-PB100KTR550F](#)