

④

公差 Inductance Tolerance
J: ±5%, K: ±10%, L: ±15%
M: ±20%, P: ±25%, N: ±30%

⑤

包装 Packing	
B	散装 Bulk Package
T	编带 Tape & Reel

◆外观尺寸:

Shape and Dimensions(dimensions are in mm):

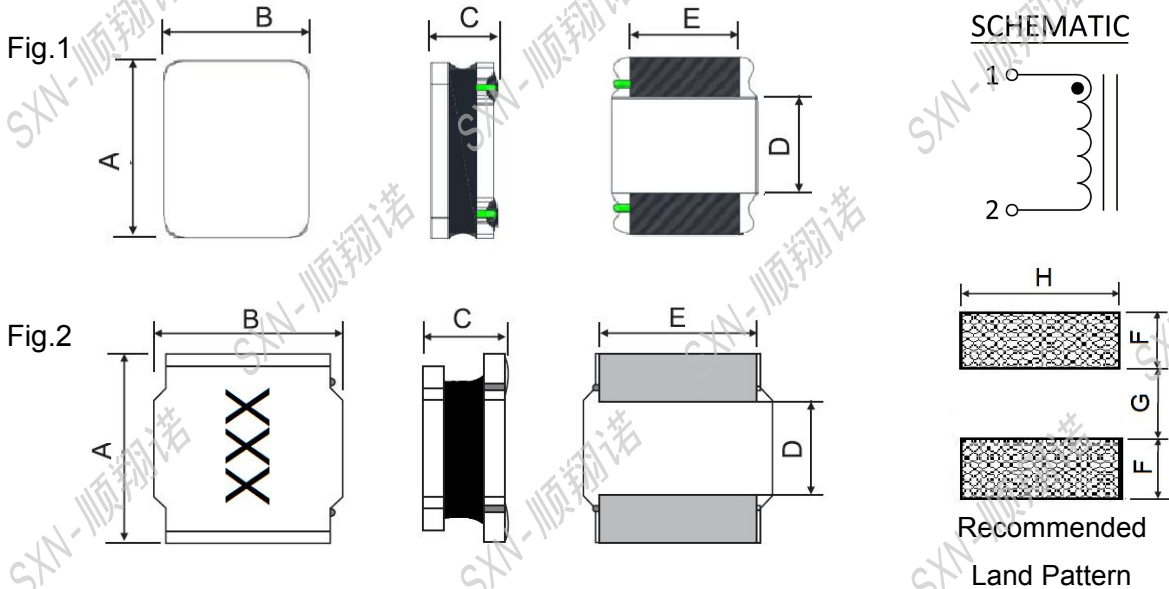

Part No	ITEM								
	Shap	A	B	C	D	E	F	G	H
SMNR201610	Fig.1	2.0±0.3	1.6±0.3	1.08 Max	0.8±0.2	1.0±0.2	0.7 Typ	0.7 Typ	1.7 Typ
SMNR252012	Fig.1	2.5±0.2	2.0±0.2	1.2 Max	0.8±0.2	1.5±0.2	0.85 Typ	0.8 Typ	2.0 Typ
SMNR3010	Fig.2	3.0±0.3	3.0±0.3	1.0 Max	1.5±0.2	2.5±0.2	0.8 Typ	1.5 Typ	2.7 Typ
SMNR3012	Fig.2	3.0±0.3	3.0±0.3	1.2 Max	1.5±0.2	2.5±0.2	0.8 Typ	1.5 Typ	2.7 Typ
SMNR3015	Fig.2	3.0±0.3	3.0±0.3	1.5 Max	1.5±0.2	2.5±0.2	0.8 Typ	1.5 Typ	2.7 Typ
SMNR4010	Fig.2	4.0±0.3	4.0±0.3	1.0 Max	2.1±0.2	3.3±0.2	1.1 Typ	1.9 Typ	3.7 Typ
SMNR4012	Fig.2	4.0±0.3	4.0±0.3	1.2 Max	2.1±0.2	3.3±0.2	1.1 Typ	1.9 Typ	3.7 Typ
SMNR4018	Fig.2	4.0±0.3	4.0±0.3	1.8 Max	2.1±0.2	3.3±0.2	1.1 Typ	1.9 Typ	3.7 Typ
SMNR4020	Fig.2	4.0±0.3	4.0±0.3	2.0 Max	2.1±0.2	3.3±0.2	1.1 Typ	1.9 Typ	3.7 Typ
SMNR4030	Fig.2	4.0±0.3	4.0±0.3	3.0 Max	2.1±0.2	3.3±0.2	1.1 Typ	1.9 Typ	3.7 Typ
SMNR5020	Fig.2	5.0±0.3	5.0±0.3	2.0 Max	2.5±0.2	4.0±0.2	1.4 Typ	2.3 Typ	4.2 Typ
SMNR5030	Fig.2	5.0±0.3	5.0±0.3	3.0 Max	2.5±0.2	4.0±0.2	1.4 Typ	2.3 Typ	4.2 Typ
SMNR5040	Fig.2	5.0±0.3	5.0±0.3	4.0 Max	2.5±0.2	4.0±0.2	1.4 Typ	2.3 Typ	4.2 Typ
SMNR6020	Fig.2	6.0±0.3	6.0±0.3	2.0 Max	2.9±0.3	4.9±0.3	1.7 Typ	2.8 Typ	5.7 Typ
SMNR6028	Fig.2	6.0±0.3	6.0±0.3	3.0 Max	2.9±0.3	4.9±0.3	1.7 Typ	2.8 Typ	5.7 Typ
SMNR6045	Fig.2	6.0±0.3	6.0±0.3	4.5 Max	2.9±0.3	4.9±0.3	1.7 Typ	2.8 Typ	5.7 Typ
SMNR8040	Fig.2	8.0±0.3	8.0±0.3	4.0 Max	4.0±0.3	6.3±0.3	2.2 Typ	3.8 Typ	7.5 Typ
SMNR8060	Fig.2	8.0±0.3	8.0±0.3	6.0 Max	4.0±0.3	6.3±0.3	2.2 Typ	3.8 Typ	7.5 Typ

◆规格特性:

Specifications:

- SMNR201610 Series Electrical Characteristics (Electrical specifications at 25°C)

Part No	Inductance 100KHz 0.25V		DCR (Ω)		Saturation Current	Temperature Rise Current
	L(μH) '@0A	Tol	Typical	Max	(A) Max	(A) Max
SMNR201610 -R24MT	0.24	±20%	0.033	0.040	3.70	2.90
SMNR201610 -R33MT	0.33	±20%	0.038	0.048	2.50	2.90
SMNR201610 -R47MT	0.47	±20%	0.047	0.059	2.30	2.35
SMNR201610 -R68MT	0.68	±20%	0.061	0.076	1.95	2.05
SMNR201610 -1R0MT	1.0	±20%	0.091	0.114	1.65	1.45
SMNR201610 -1R5MT	1.5	±20%	0.139	0.174	1.35	1.10
SMNR201610 -2R2MT	2.2	±20%	0.211	0.264	1.20	1.10
SMNR201610 -3R3MT	3.3	±20%	0.268	0.335	0.90	0.88
SMNR201610 -4R7MT	4.7	±20%	0.383	0.479	0.74	0.70
SMNR201610 -6R8MT	6.8	±20%	0.652	0.816	0.60	0.52
SMNR201610 -100MT	10.0	±20%	0.816	1.020	0.50	0.45

- Saturation current VS temperature rise current curve



● SMNR252012 Series Electrical Characteristics (Electrical specifications at 25°C)

Part No	Inductance 100KHz 0.25V		DCR (Ω)		Saturation Current	Temperature Rise Current
	L(μ H) @0A	Tol	Typical	Max	(A) Max	(A) Max
SMNR252012 -R68NT	0.68	$\pm 30\%$	0.059	0.074	3.28	1.95
SMNR252012 -1R0NT	1.0	$\pm 30\%$	0.072	0.090	2.59	1.93
SMNR252012 -1R5MT	1.5	$\pm 20\%$	0.117	0.147	2.24	1.40
SMNR252012 -2R2MT	2.2	$\pm 20\%$	0.173	0.216	1.85	1.15
SMNR252012 -3R3MT	3.3	$\pm 20\%$	0.211	0.264	1.61	1.04
SMNR252012 -4R7MT	4.7	$\pm 20\%$	0.302	0.377	1.12	0.84
SMNR252012 -5R6MT	5.6	$\pm 20\%$	0.430	0.538	1.11	0.73
SMNR252012 -6R8MT	6.8	$\pm 20\%$	0.464	0.581	0.98	0.69
SMNR252012 -8R2MT	8.2	$\pm 20\%$	0.526	0.658	0.98	0.65
SMNR252012 -100MT	10	$\pm 20\%$	0.552	0.690	0.79	0.62
SMNR252012 -150MT	15	$\pm 20\%$	1.273	1.591	0.68	0.42
SMNR252012 -220MT	22	$\pm 20\%$	1.459	1.824	0.53	0.38

● Saturation current VS temperature rise current curve

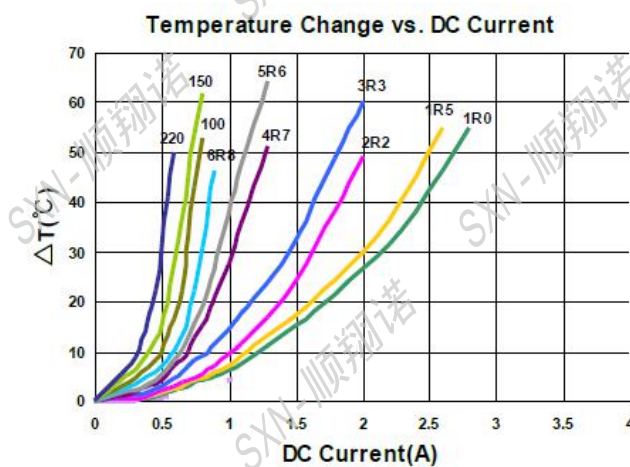
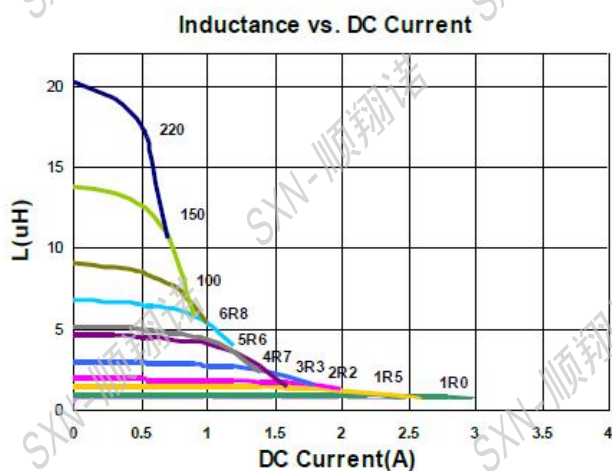

● SMNR3010 Series Electrical Characteristics (Electrical specifications at 25 °C)

Part No	Inductance 100KHz 1.0V		DCR (Ω)		Saturation Current	Temperature Rise Current
	L(μH) @0A	Tol	Typical	Max	(A) Max	(A) Max
SMNR3010 -1R0M	1.0	±20%	0.065	0.085	1.40	1.45
SMNR3010 -1R5M	1.5	±20%	0.085	0.104	1.27	1.30
SMNR3010 -2R2M	2.2	±20%	0.110	0.143	1.15	1.09
SMNR3010 -3R3M	3.3	±20%	0.150	0.189	0.97	0.96
SMNR3010 -4R7M	4.7	±20%	0.230	0.290	0.75	0.77
SMNR3010 -6R8M	6.8	±20%	0.305	0.340	0.55	0.66
SMNR3010 -100M	10	±20%	0.400	0.520	0.55	0.58
SMNR3010 -150M	15	±20%	0.610	0.800	0.42	0.47
SMNR3010 -220M	22	±20%	0.930	1.209	0.35	0.38
SMNR3010 -330M	33	±20%	1.550	2.020	0.29	0.30
SMNR3010 -470M	47	±20%	2.000	2.535	0.22	0.26

● Saturation current VS temperature rise current curve

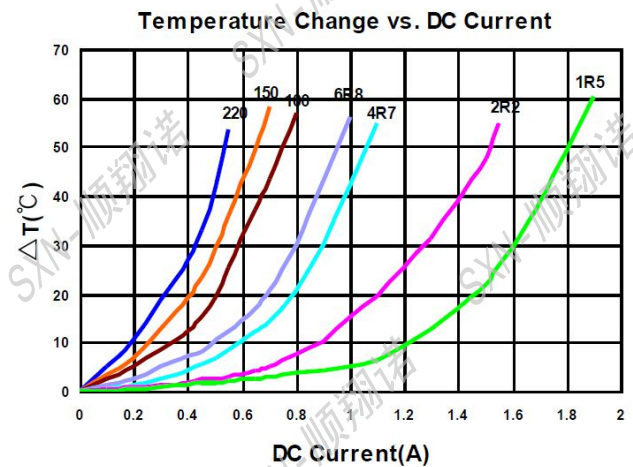
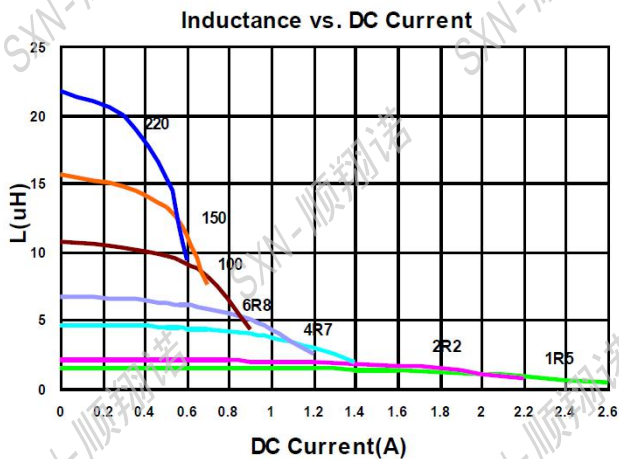

• SMNR3012 Series Electrical Characteristics (Electrical specifications at 25 °C)

Part No	Inductance 100KHz 1.0V		DCR (Ω)		Saturation Current	Temperature Rise Current
	L(μH) @0A	Tol	Typical	Max	(A) Max	(A) Max
SMNR3012 -R24M	0.24	±20%	0.020	0.029	4.00	3.00
SMNR3012 -1R0M	1.0	±20%	0.040	0.052	1.87	2.20
SMNR3012 -1R5M	1.5	±20%	0.045	0.060	1.62	2.00
SMNR3012 -2R2M	2.2	±20%	0.070	0.080	1.20	1.55
SMNR3012 -3R3M	3.3	±20%	0.100	0.130	1.05	1.36
SMNR3012 -4R7M	4.7	±20%	0.120	0.156	0.90	1.24
SMNR3012 -6R8M	6.8	±20%	0.190	0.247	0.75	0.98
SMNR3012 -100M	10	±20%	0.265	0.345	0.60	0.83
SMNR3012 -150M	15	±20%	0.360	0.468	0.45	0.71
SMNR3012 -220M	22	±20%	0.645	0.839	0.42	0.47

• Saturation current VS temperature rise current curve

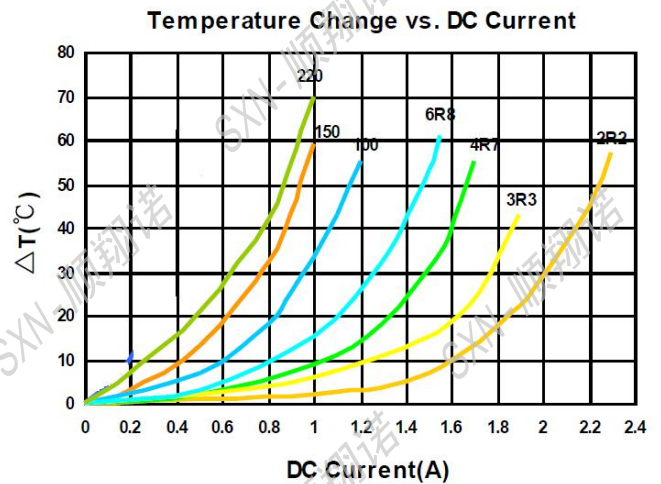
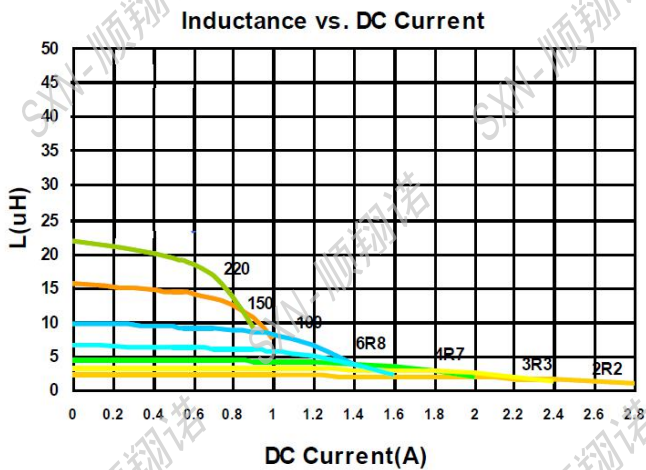

● SMNR3015 Series Electrical Characteristics (Electrical specifications at 25 °C)

Part No	Inductance 100KHz 1.0V		DCR (Ω)		Saturation Current	Temperature Rise Current
	L(μH) @0A	Tol	Typical	Max	(A) Max	(A) Max
SMNR3015 -R47M	0.47	±20%	0.024	0.035	2.50	2.60
SMNR3015 -1R0M	1.0	±20%	0.030	0.039	2.32	2.35
SMNR3015 -1R5M	1.5	±20%	0.050	0.065	2.30	1.70
SMNR3015 -1R8M	1.8	±20%	0.050	0.065	1.75	1.70
SMNR3015 -2R2M	2.2	±20%	0.060	0.078	1.60	1.60
SMNR3015 -3R3M	3.3	±20%	0.080	0.104	1.32	1.36
SMNR3015 -4R7M	4.7	±20%	0.125	0.165	1.10	1.09
SMNR3015 -6R8M	6.8	±20%	0.200	0.260	0.85	0.85
SMNR3015 -100M	10	±20%	0.250	0.325	0.72	0.77
SMNR3015 -150M	15	±20%	0.350	0.455	0.66	0.65
SMNR3015 -220M	22	±20%	0.460	0.598	0.52	0.57
SMNR3015 -330M	33	±20%	0.820	1.066	0.44	0.43
SMNR3015 -470M	47	±20%	1.250	1.625	0.35	0.35

● Saturation current VS temperature rise current curve

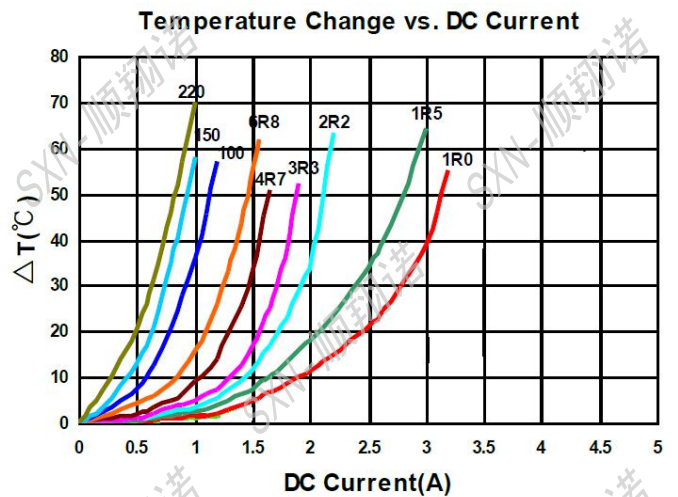
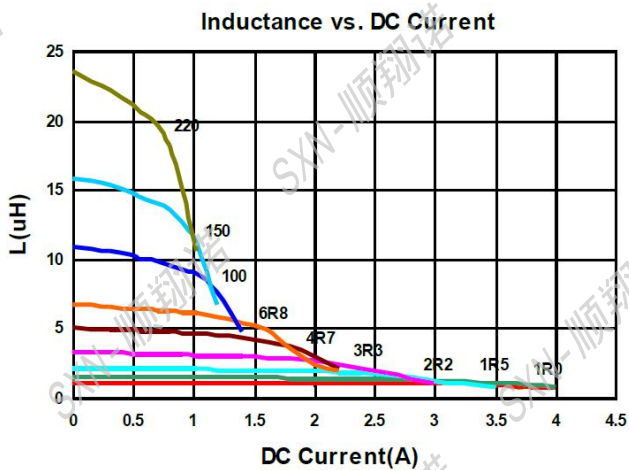

● SMNR4010 Series Electrical Characteristics (Electrical specifications at 25 °C)

Part No	Inductance 100KHz 1.0V		DCR (Ω)		Saturation Current	Temperature Rise Current
	L(μH) @0A	Tol	Typical	Max	(A) Max	(A) Max
SMNR4010 -1R0M	1.0	±20%	0.056	0.070	2.00	1.90
SMNR4010 -2R2M	2.2	±20%	0.085	0.105	1.20	1.50
SMNR4010 -3R3M	3.3	±20%	0.105	0.125	1.10	1.40
SMNR4010 -4R7M	4.7	±20%	0.185	0.260	0.95	1.20
SMNR4010 -6R8M	6.8	±20%	0.189	0.270	0.80	1.00
SMNR4010 -100M	10	±20%	0.266	0.380	0.62	0.75
SMNR4010 -150M	15	±20%	0.385	0.550	0.54	0.60
SMNR4010 -220M	22	±20%	0.490	0.700	0.45	0.50
SMNR4010 -330M	33	±20%	0.546	0.780	0.28	0.32
SMNR4010 -470M	47	±20%	0.693	0.990	0.16	0.20

● Saturation current VS temperature rise current curve

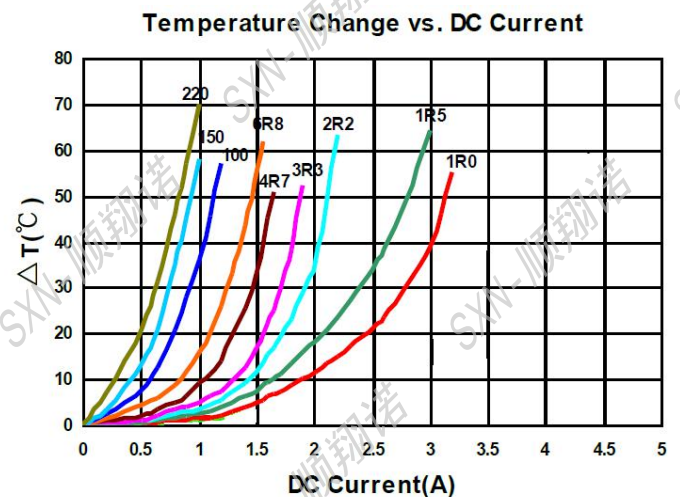
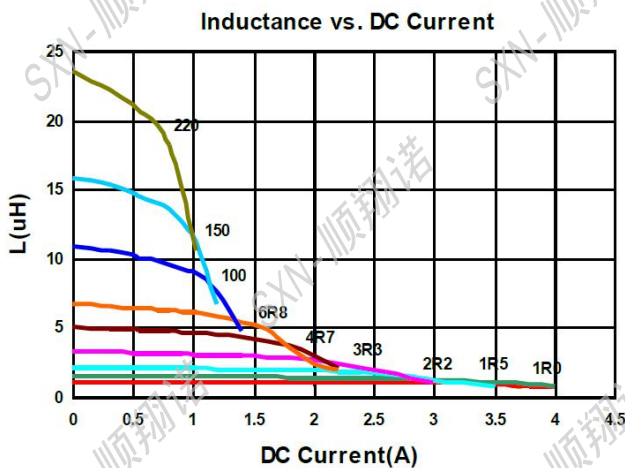

• SMNR4012 Series Electrical Characteristics (Electrical specifications at 25 °C)

Part No	Inductance 100KHz 1.0V		DCR (Ω)		Saturation Current	Temperature Rise Current
	L(μH) @0A	Tol	Typical	Max	(A) Max	(A) Max
SMNR4012 -1R0M	1.0	±20%	0.050	0.065	2.61	1.65
SMNR4012 -1R5M	1.5	±20%	0.065	0.094	2.50	1.46
SMNR4012 -2R2M	2.2	±20%	0.080	0.104	1.76	1.32
SMNR4012 -3R3M	3.3	±20%	0.110	0.143	1.72	1.12
SMNR4012 -4R7M	4.7	±20%	0.125	0.163	1.15	1.05
SMNR4012 -6R8M	6.8	±20%	0.198	0.257	0.85	0.84
SMNR4012 -100M	10	±20%	0.265	0.345	0.80	0.77
SMNR4012 -150M	15	±20%	0.340	0.442	0.56	0.64
SMNR4012 -220M	22	±20%	0.587	0.763	0.46	0.49
SMNR4012 -330M	33	±20%	0.810	1.053	0.42	0.42
SMNR4012 -470M	47	±20%	1.100	1.430	0.35	0.37

• Saturation current VS temperature rise current curve

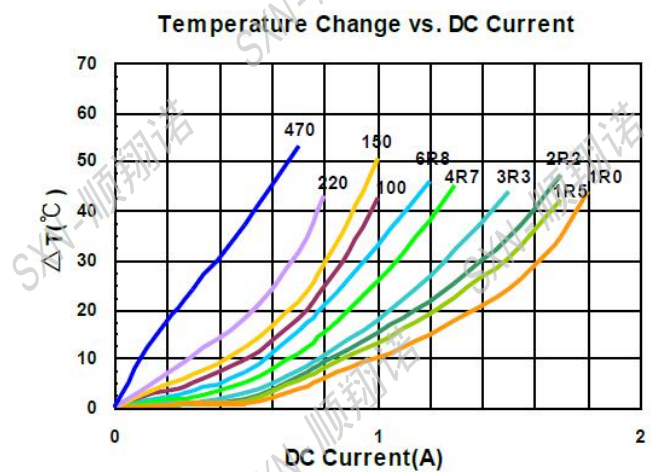

● SMNR4018 Series Electrical Characteristics (Electrical specifications at 25 °C)

Part No	Inductance 100KHz 1.0V		DCR (Ω)		Saturation Current	Temperature Rise Current
	L(μH) '@0A	Tol	Typical	Max	(A) Max	(A) Max
SMNR4018 -R24M	0.24	±20%	0.0140	0.018	4.30	4.00
SMNR4018 -1R0M	1.0	±20%	0.025	0.033	4.80	2.00
SMNR4018 -1R5M	1.5	±20%	0.030	0.039	3.35	1.80
SMNR4018 -2R2M	2.2	±20%	0.34	0.550	2.70	1.65
SMNR4018 -3R3M	3.3	±20%	0.070	0.091	2.45	1.23
SMNR4018 -4R7M	4.7	±20%	0.090	0.115	1.70	1.20
SMNR4018 -6R8M	6.8	±20%	0.110	0.140	1.45	1.06
SMNR4018 -100M	10	±20%	0.180	0.230	1.30	0.84
SMNR4018 -150M	15	±20%	0.250	0.320	0.94	0.65
SMNR4018 -220M	22	±20%	0.360	0.450	0.80	0.59
SMNR4018 -330M	33	±20%	0.530	0.689	0.56	0.49
SMNR4018 -470M	47	±20%	0.650	0.845	0.57	0.42
SMNR4018 -680M	68	±20%	1.000	1.300	0.47	0.32
SMNR4018 -101M	100	±20%	1.750	2.200	0.40	0.25
SMNR4018 -151M	150	±20%	2.500	3.000	0.31	0.22

● Saturation current VS temperature rise current curve

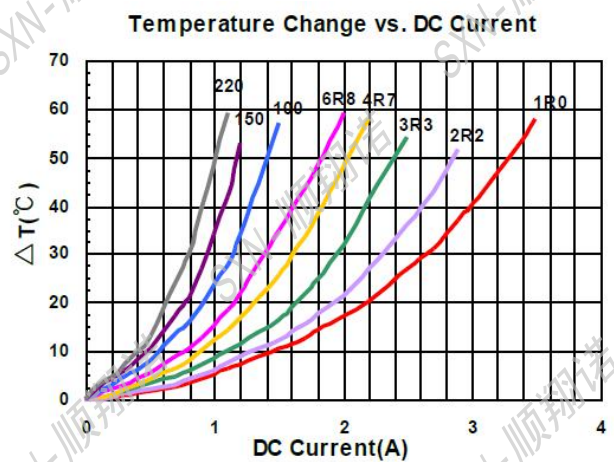

● SMNR4020 Series Electrical Characteristics (Electrical specifications at 25 °C)

Part No	Inductance 100KHz 1.0V		DCR (Ω)		Saturation Current	Temperature Rise Current
	L(μH) @0A	Tol	Typical	Max	(A) Max	(A) Max
SMNR4020 -R47M	0.47	±20%	0.022	0.029	7.00	3.30
SMNR4020 -1R0M	1.0	±20%	0.029	0.038	4.78	2.15
SMNR4020 -1R5M	1.5	±20%	0.035	0.045	4.45	2.15
SMNR4020 -2R2M	2.2	±20%	0.035	0.046	3.40	1.85
SMNR4020 -3R3M	3.3	±20%	0.070	0.091	3.20	1.40
SMNR4020 -4R7M	4.7	±20%	0.075	0.098	2.35	1.34
SMNR4020 -6R8M	6.8	±20%	0.125	0.163	2.20	1.04
SMNR4020 -8R2M	8.2	±20%	0.148	0.185	1.75	1.00
SMNR4020 -100M	10	±20%	0.165	0.215	1.60	0.90
SMNR4020 -150M	15	±20%	0.230	0.300	1.35	0.77
SMNR4020 -220M	22	±20%	0.350	0.455	1.05	0.62
SMNR4020 -330M	33	±20%	0.550	0.710	0.85	0.49
SMNR4020 -470M	47	±20%	0.710	0.920	0.74	0.44
SMNR4020 -680M	68	±20%	1.060	1.380	0.60	0.36

● Saturation current VS temperature rise current curve

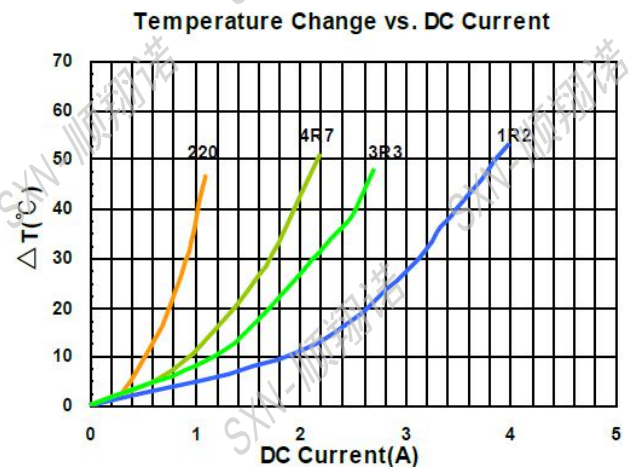
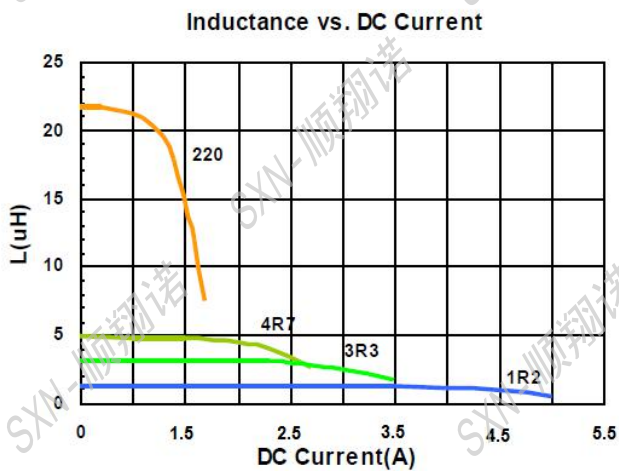

● SMNR4030 Series Electrical Characteristics (Electrical specifications at 25 °C)

Part No	Inductance 100KHz 1.0V		DCR (Ω)		Saturation Current	Temperature Rise Current
	L(μH) @0A	Tol	Typical	Max	(A) Max	(A) Max
SMNR4030 -1R0M	1.0	±20%	0.014	0.018	5.26	4.15
SMNR4030 -1R2M	1.2	±20%	0.015	0.020	5.26	3.82
SMNR4030 -1R5M	1.5	±20%	0.020	0.026	4.84	3.34
SMNR4030 -1R8M	1.8	±20%	0.025	0.033	4.84	3.20
SMNR4030 -2R2M	2.2	±20%	0.030	0.039	4.40	2.95
SMNR4030 -3R3M	3.3	±20%	0.040	0.050	3.30	2.40
SMNR4030 -4R7M	4.7	±20%	0.060	0.076	2.90	2.00
SMNR4030 -6R8M	6.8	±20%	0.090	0.115	2.75	1.60
SMNR4030 -8R2M	8.2	±20%	0.095	0.122	2.10	1.60
SMNR4030 -100M	10	±20%	0.100	0.130	1.95	1.50
SMNR4030 -120M	12	±20%	0.135	0.172	1.70	1.30
SMNR4030 -150M	15	±20%	0.190	0.230	1.65	1.11
SMNR4030 -220M	22	±20%	0.225	0.290	1.30	1.00
SMNR4030 -330M	33	±20%	0.330	0.420	1.10	0.84
SMNR4030 -470M	47	±20%	0.445	0.570	0.95	0.72
SMNR4030 -680M	68	±20%	0.868	1.100	0.72	0.52
SMNR4030 -820M	82	±20%	1.060	1.280	0.66	0.47
SMNR4030 -101M	100	±20%	1.150	1.480	0.60	0.45
SMNR4030 -121M	120	±20%	1.350	1.700	0.55	0.42

● Saturation current VS temperature rise current curve

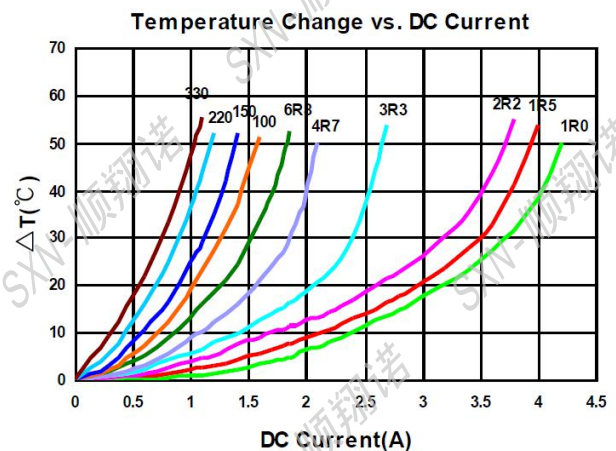
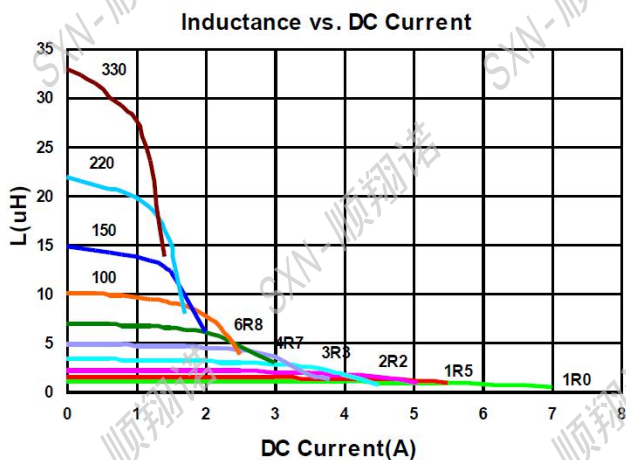

● SMNR5020 Series Electrical Characteristics (Electrical specifications at 25 °C)

Part No	Inductance 100KHz 1.0V		DCR (Ω)		Saturation Current	Temperature Rise Current
	L(μH) @0A	Tol	Typical	Max	(A) Max	(A) Max
SMNR5020 -R47M	0.47	±20%	0.017	0.021	4.50	4.60
SMNR5020 -1R0M	1.0	±20%	0.020	0.025	4.10	3.80
SMNR5020 -1R5M	1.5	±20%	0.026	0.032	3.80	3.20
SMNR5020 -2R2M	2.2	±20%	0.032	0.040	3.20	2.90
SMNR5020 -3R3M	3.3	±20%	0.043	0.054	2.55	2.50
SMNR5020 -3R9M	3.9	±20%	0.043	0.054	2.30	2.50
SMNR5020 -4R7M	4.7	±20%	0.057	0.074	2.40	2.20
SMNR5020 -6R8M	6.8	±20%	0.083	0.107	2.05	1.80
SMNR5020 -8R2M	8.2	±20%	0.098	0.125	1.85	1.65
SMNR5020 -100M	10	±20%	0.110	0.140	1.70	1.55
SMNR5020 -120M	12	±20%	0.140	0.180	1.50	1.40
SMNR5020 -150M	15	±20%	0.165	0.210	1.35	1.25
SMNR5020 -220M	22	±20%	0.226	0.290	1.15	1.10
SMNR5020 -330M	33	±20%	0.390	0.500	0.95	0.90
SMNR5020 -470M	47	±20%	0.523	0.670	0.77	0.77
SMNR5020 -680M	68	±20%	0.740	1.050	0.72	0.64
SMNR5020 -820M	82	±20%	1.000	1.280	0.66	0.50
SMNR5020 -101M	100	±20%	1.100	1.480	0.57	0.53
SMNR5020 -121M	120	±20%	1.350	1.700	0.49	0.40

● Saturation current VS temperature rise current curve

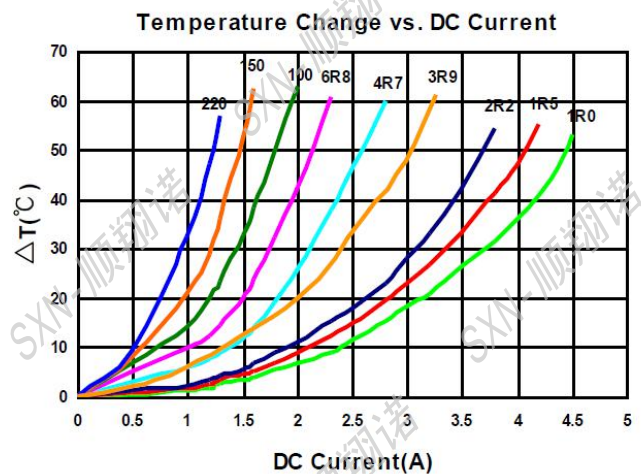
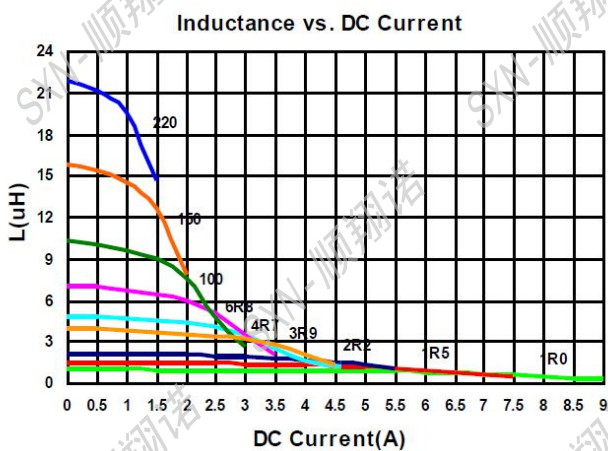

● SMNR5030 Series Electrical Characteristics (Electrical specifications at 25 °C)

Part No	Inductance 100KHz 0.25V		DCR (Ω)		Saturation Current	Temperature Rise Current
	L(μH) @0A	Tol	Typical	Max	(A) Max	(A) Max
SMNR5030 -1R0M	1.0	±20%	0.016	0.020	7.00	4.00
SMNR5030 -1R5N	1.5	±30%	0.019	0.024	5.50	3.60
SMNR5030 -2R2N	2.2	±30%	0.025	0.031	4.50	3.20
SMNR5030 -3R3N	3.3	±30%	0.032	0.039	4.00	2.80
SMNR5030 -4R7M	4.7	±20%	0.052	0.065	3.00	2.20
SMNR5030 -5R6N	5.6	±30%	0.056	0.070	3.00	2.10
SMNR5030 -6R8M	6.8	±20%	0.060	0.075	2.80	2.00
SMNR5030 -100M	10	±20%	0.080	0.100	2.10	1.80
SMNR5030 -150M	15	±20%	0.125	0.156	1.70	1.40
SMNR5030 -220M	22	±20%	0.210	0.260	1.60	1.10
SMNR5030 -330M	33	±20%	0.330	0.410	1.20	0.85
SMNR5030 -470M	47	±20%	0.375	0.468	0.90	0.80
SMNR5030 -101M	100	±20%	0.800	0.988	0.75	0.56
SMNR5030 -151M	150	±20%	1.180	1.470	0.55	0.46
SMNR5030 -221M	220	±20%	1.700	2.080	0.45	0.39
SMNR5030 -331M	330	±20%	2.800	3.500	0.35	0.30
SMNR5030 -471M	470	±20%	3.800	4.700	0.30	0.26
SMNR5030 -102M	1000	±20%	8.700	10.800	0.20	0.17

● SMNR5040 Series Electrical Characteristics (Electrical specifications at 25 °C)

Part No	Inductance 100KHz 1.0V		DCR (Ω)		Saturation Current	Temperature Rise Current
	L(μH) '@0A	Tol	Typical	Max	(A) Max	(A) Max
SMNR5040 -1R0M	1.0	±20%	0.012	0.018	7.35	4.90
SMNR5040 -1R2M	1.2	±20%	0.016	0.021	6.50	4.30
SMNR5040 -1R5M	1.5	±20%	0.015	0.020	6.30	4.30
SMNR5040 -2R2M	2.2	±20%	0.019	0.025	4.90	3.80
SMNR5040 -3R3M	3.3	±20%	0.024	0.031	3.95	3.40
SMNR5040 -4R7M	4.7	±20%	0.030	0.039	3.50	3.00
SMNR5040 -6R8M	6.8	±20%	0.043	0.056	2.90	2.50
SMNR5040 -8R2M	8.2	±20%	0.050	0.070	2.70	2.30
SMNR5040 -100M	10	±20%	0.064	0.082	2.35	2.10
SMNR5040 -120M	12	±20%	0.077	0.102	2.20	2.00
SMNR5040 -150M	15	±20%	0.086	0.115	2.00	2.00
SMNR5040 -220M	22	±20%	0.129	0.167	1.60	1.50
SMNR5040 -330M	33	±20%	0.188	0.244	1.30	1.20
SMNR5040 -470M	47	±20%	0.272	0.353	1.10	1.00
SMNR5040 -680M	68	±20%	0.400	0.520	0.90	0.80
SMNR5040 -820M	82	±20%	0.560	0.660	0.80	0.75
SMNR5040 -101M	100	±20%	0.509	0.728	0.75	0.70
SMNR5040 -121M	120	±20%	0.665	0.864	0.70	0.65
SMNR5040 -151M	150	±20%	0.750	0.975	0.65	0.60
SMNR5040 -221M	220	±20%	1.400	1.820	0.48	0.40
SMNR5040 -331M	330	±20%	2.000	2.730	0.42	0.40
SMNR5040 -471M	470	±20%	3.000	3.900	0.37	0.35
SMNR5040 -681M	680	±20%	3.900	5.070	0.30	0.25
SMNR5040 -102M	1000	±20%	6.000	7.800	0.21	0.23

● Saturation current VS temperature rise current curve

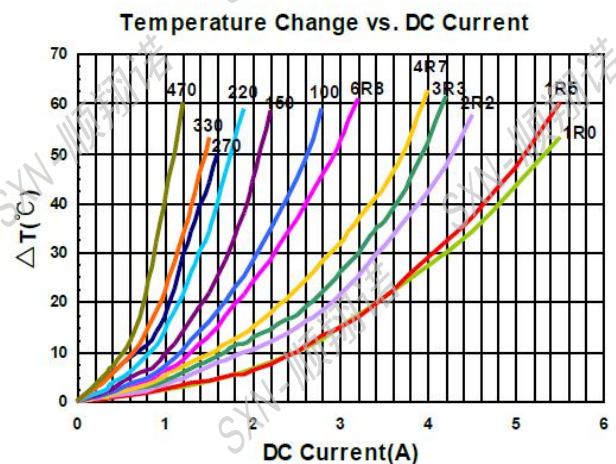
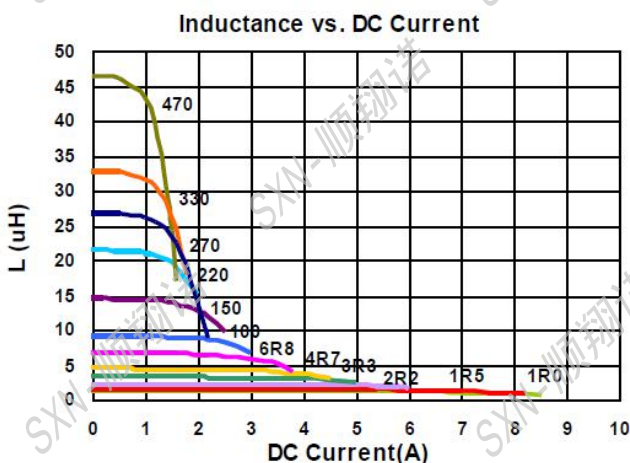

● SMNR6020 Series Electrical Characteristics (Electrical specifications at 25 °C)

Part No	Inductance 100KHz 1.0V		DCR (Ω)		Saturation Current	Temperature Rise Current
	L(μH) @0A	Tol	Typical	Max	(A) Max	(A) Max
SMNR6020 -R68M	0.68	±20%	0.017	0.022	6.55	3.80
SMNR6020 -R82M	0.82	±20%	0.017	0.023	5.30	3.80
SMNR6020 -1R0M	1.0	±20%	0.018	0.026	4.15	3.50
SMNR6020 -1R5M	1.5	±20%	0.022	0.028	4.10	3.20
SMNR6020 -1R8M	1.8	±20%	0.028	0.036	4.05	2.75
SMNR6020 -2R2M	2.2	±20%	0.028	0.038	4.00	2.75
SMNR6020 -3R3M	3.3	±20%	0.035	0.045	3.15	2.60
SMNR6020 -3R9M	3.9	±20%	0.049	0.060	3.10	2.10
SMNR6020 -4R7M	4.7	±20%	0.058	0.075	3.00	2.00
SMNR6020 -5R6M	5.6	±20%	0.058	0.077	2.40	1.90
SMNR6020 -6R8M	6.8	±20%	0.079	0.100	2.20	1.80
SMNR6020 -8R2M	8.2	±20%	0.105	0.130	2.10	1.40
SMNR6020 -100M	10	±20%	0.105	0.135	1.75	1.40
SMNR6020 -120M	12	±20%	0.120	0.150	1.45	1.30
SMNR6020 -150M	15	±20%	0.145	0.188	1.20	1.20
SMNR6020 -180M	18	±20%	0.180	0.230	1.16	1.08
SMNR6020 -220M	22	±20%	0.204	0.260	1.05	1.00

● Saturation current VS temperature rise current curve

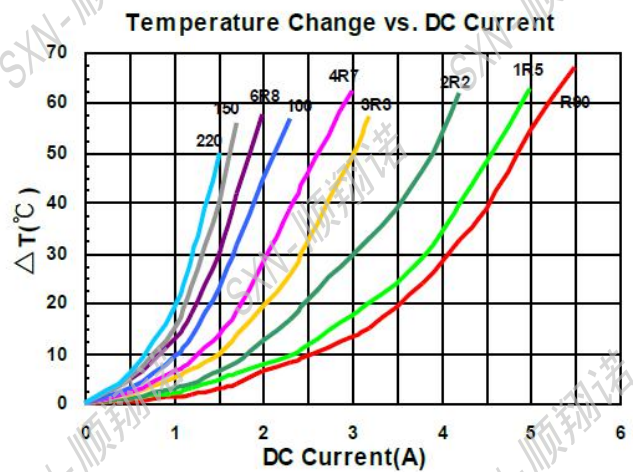
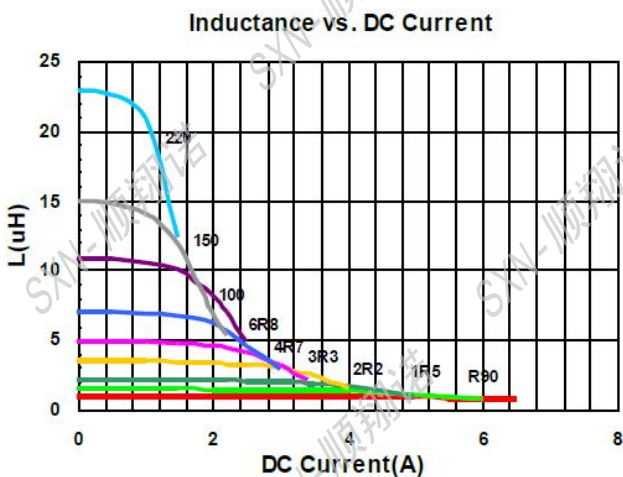

● SMNR6028 Series Electrical Characteristics (Electrical specifications at 25 °C)

Part No	Inductance 100KHz 1.0V		DCR (Ω)		Saturation Current	Temperature Rise Current
	L(μH) '@0A	Tol	Typical	Max	(A) Max	(A) Max
SMNR6028 -R68M	0.68	±20%	0.010	0.013	6.90	5.20
SMNR6028 -1R0M	1.0	±20%	0.010	0.013	5.75	5.20
SMNR6028 -1R5M	1.5	±20%	0.013	0.016	5.50	4.58
SMNR6028 -2R2M	2.2	±20%	0.020	0.026	5.10	3.75
SMNR6028 -3R3M	3.3	±20%	0.025	0.032	4.15	3.48
SMNR6028 -4R7M	4.7	±20%	0.030	0.039	3.00	3.08
SMNR6028 -6R8M	6.8	±20%	0.047	0.061	2.60	2.40
SMNR6028 -8R2M	8.2	±20%	0.055	0.071	2.30	2.25
SMNR6028 -100M	10	±30%	0.074	0.093	2.04	1.95
SMNR6028 -120M	12	±30%	0.080	0.104	1.80	1.85
SMNR6028 -150M	15	±30%	0.125	0.162	1.75	1.45
SMNR6028 -180M	18	±30%	0.120	0.169	1.52	1.45
SMNR6028 -220M	22	±30%	0.140	0.182	1.45	1.40
SMNR6028 -330M	33	±20%	0.185	0.240	1.35	1.22
SMNR6028 -390M	39	±20%	0.225	0.292	1.25	1.10
SMNR6028 -470M	47	±20%	0.315	0.400	1.15	1.06
SMNR6028 -680M	68	±20%	0.360	0.468	0.80	0.86
SMNR6028 -820M	82	±20%	0.500	0.650	0.75	0.70
SMNR6028 -101M	100	±20%	0.550	0.675	0.65	0.70

● Saturation current VS temperature rise current curve

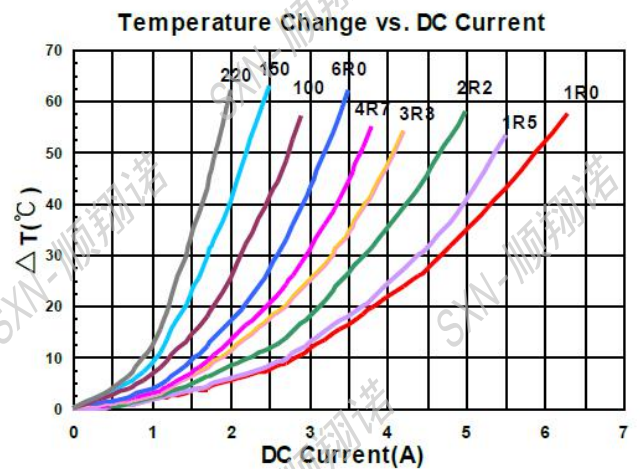
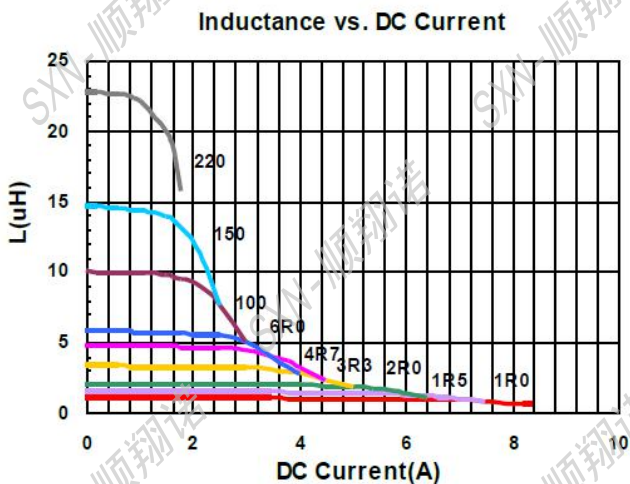

● SMNR6045 Series Electrical Characteristics (Electrical specifications at 25 °C)

Part No	Inductance 100KHz 1.0V		DCR (Ω)		Saturation Current	Temperature Rise Current
	L(μH) @0A	Tol	Typical	Max	(A) Max	(A) Max
SMNR6045 -1R0M	1.0	±20%	0.011	0.014	9.85	5.14
SMNR6045 -1R5M	1.5	±20%	0.012	0.015	8.80	4.95
SMNR6045 -2R2M	2.2	±20%	0.014	0.018	6.75	4.60
SMNR6045 -3R3M	3.3	±20%	0.021	0.027	5.90	3.70
SMNR6045 -4R7M	4.7	±20%	0.026	0.033	4.97	3.30
SMNR6045 -6R8M	6.8	±20%	0.031	0.040	3.90	3.00
SMNR6045 -100M	10	±20%	0.048	0.062	3.20	2.45
SMNR6045 -150M	15	±20%	0.068	0.088	2.50	2.05
SMNR6045 -220M	22	±20%	0.089	0.115	2.05	1.80
SMNR6045 -330M	33	±20%	0.137	0.178	1.65	1.50
SMNR6045-470M	47	±20%	0.200	0.260	1.40	1.20
SMNR6045-680M	68	±20%	0.286	0.375	1.20	1.00
SMNR6045-820M	82	±20%	0.341	0.440	1.05	0.90
SMNR6045-101M	100	±20%	0.433	0.562	0.95	0.80
SMNR6045-121M	120	±20%	0.484	0.628	0.85	0.77
SMNR6045-151M	150	±20%	0.580	0.750	0.80	0.70
SMNR6045-221M	220	±20%	0.834	1.050	0.70	0.59
SMNR6045-331M	330	±20%	1.270	1.650	0.57	0.57
SMNR6045-471M	470	±20%	1.800	2.340	0.50	0.42
SMNR6045-681M	680	±20%	2.500	3.250	0.42	0.33
SMNR6045-102M	1000	±20%	4.500	5.850	0.30	0.30

● Saturation current VS temperature rise current curve

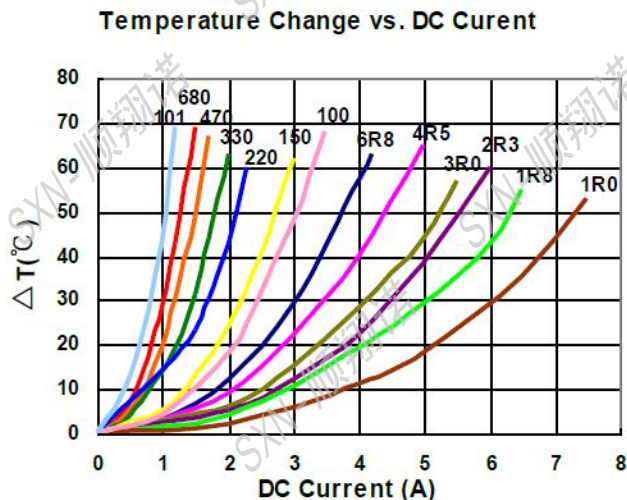

• SMNR8040 Series Electrical Characteristics (Electrical specifications at 25 °C)

Part No	Inductance 100KHz 1.0V		DCR (Ω)		Saturation Current	Temperature Rise Current
	L(μH) @0A	Tol	Typical	Max	(A) Max	(A) Max
SMNR8040 -1R0M	1.0	±20%	0.008	0.010	9.85	6.30
SMNR8040 -1R5M	1.5	±20%	0.010	0.013	8.15	5.65
SMNR8040 -2R2M	2.2	±20%	0.012	0.015	7.10	5.15
SMNR8040 -3R3M	3.3	±20%	0.017	0.022	6.50	4.40
SMNR8040 -3R6M	3.6	±20%	0.017	0.022	6.50	4.35
SMNR8040 -4R7M	4.7	±20%	0.019	0.024	5.90	4.10
SMNR8040 -5R6M	5.6	±20%	0.021	0.027	4.55	3.85
SMNR8040 -6R8M	6.8	±20%	0.024	0.031	4.55	3.60
SMNR8040 -8R2M	8.2	±20%	0.026	0.033	4.20	3.45
SMNR8040 -100M	10	±20%	0.029	0.037	3.60	3.30
SMNR8040 -150M	15	±20%	0.047	0.061	2.95	2.80
SMNR8040 -180M	18	±20%	0.053	0.068	2.70	2.40
SMNR8040 -220M	22	±20%	0.069	0.089	2.40	2.10
SMNR8040 -270M	27	±20%	0.078	0.101	2.15	2.00
SMNR8040 -330M	33	±20%	0.097	0.126	2.05	1.80
SMNR8040 -390M	39	±20%	0.107	0.139	1.95	1.70
SMNR8040-470M	47	±20%	0.136	0.176	1.75	1.55
SMNR8040-680M	68	±20%	0.196	0.254	1.45	1.25
SMNR8040 -820M	82	±20%	0.225	0.292	1.30	1.15
SMNR8040-101M	100	±20%	0.290	0.377	1.15	1.00
SMNR8040 -121M	120	±20%	0.334	0.434	1.12	0.95
SMNR8040 -151M	150	±20%	0.410	0.553	1.10	0.85
SMNR8040 -221M	220	±20%	0.599	0.778	0.85	0.80
SMNR8040 -331M	330	±20%	0.889	1.155	0.68	0.64
SMNR8040 -471M	470	±20%	1.260	1.625	0.60	0.50
SMNR8040 -681M	680	±20%	2.040	2.652	0.50	0.45
SMNR8040 -102M	1000	±20%	2.800	3.640	0.40	0.35

• Saturation current VS temperature rise current curve
Inductance vs. DC Current

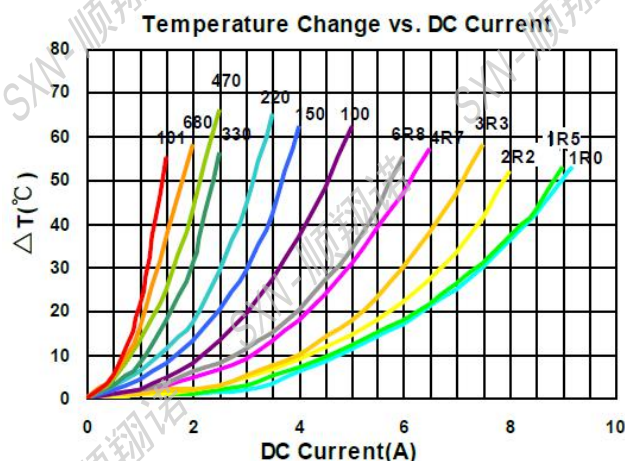
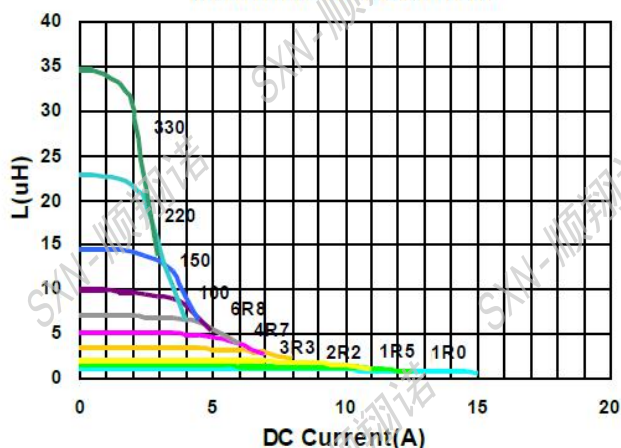

● SMNR8060 Series Electrical Characteristics (Electrical specifications at 25 °C)

Part No	Inductance 100KHz 1.0V		DCR (Ω)		Saturation Current	Temperature Rise Current
	L(μH) @0A	Tol	Typical	Max	(A) Max	(A) Max
SMNR8060 -2R2M	2.2	±20%	0.015	0.022	8.00	5.70
SMNR8060 -3R3M	3.3	±20%	0.017	0.025	7.50	5.00
SMNR8060 -4R7M	4.7	±20%	0.022	0.032	7.00	4.65
SMNR8060 -6R8M	6.8	±20%	0.025	0.037	5.90	4.20
SMNR8060 -100M	10	±20%	0.029	0.042	5.80	3.80
SMNR8060 -150M	15	±20%	0.049	0.071	4.50	3.10
SMNR8060 -220M	22	±20%	0.070	0.100	4.30	2.70
SMNR8060 -330M	33	±20%	0.113	0.162	3.00	2.10
SMNR8060-470M	47	±20%	0.131	0.188	2.85	1.80
SMNR8060-680M	68	±20%	0.173	0.248	2.50	1.60
SMNR8060-101M	100	±20%	0.266	0.380	2.00	1.25
SMNR8060 -221M	220	±20%	0.618	0.884	1.20	0.82
SMNR8060 -331M	330	±20%	0.88	1.260	1.05	0.68
SMNR8060 -471M	470	±20%	1.23	1.760	0.90	0.55
SMNR8060 -681M	680	±20%	1.96	2.800	0.80	0.50
SMNR8060 -821M	820	±20%	2.38	3.400	0.70	0.43
SMNR8060 -102M	1000	±20%	2.71	3.870	0.60	0.37

- Saturation Current: DC current at which inductance drops 30% from its value without current.
- Temperature Rise Current: the actual value of DC current when the temperature rise is $\Delta T 40^{\circ}\text{C}$ ($T_a=25^{\circ}\text{C}$).
- Rated DC Current: The less value which is Isat or Irms.
- Special remind: Circuit design, component, PCB trace size and thickness, airflow and other cooling provisions all affect the part temperature. Part temperature should be verified in the end application.
- Saturation current VS temperature rise current curve

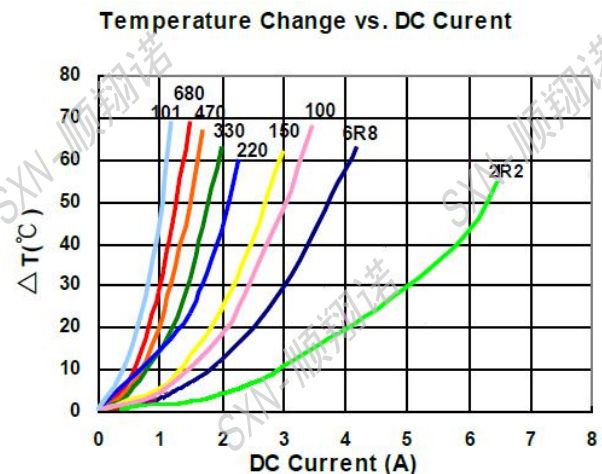
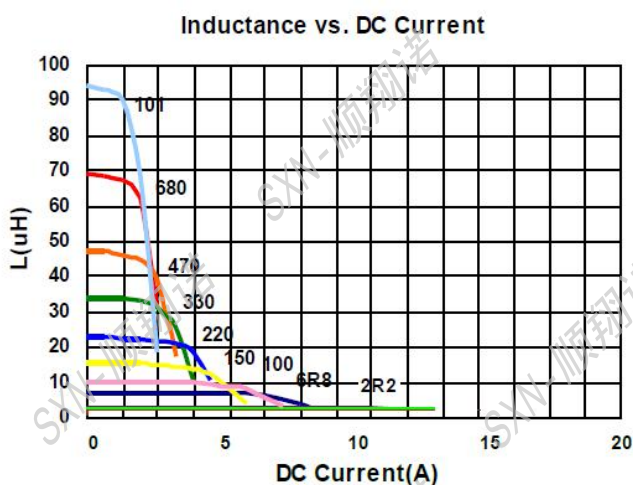

◆ 产品包装:

Packaging:

● Tape and Reel Specifications: (Dimensions are in mm)

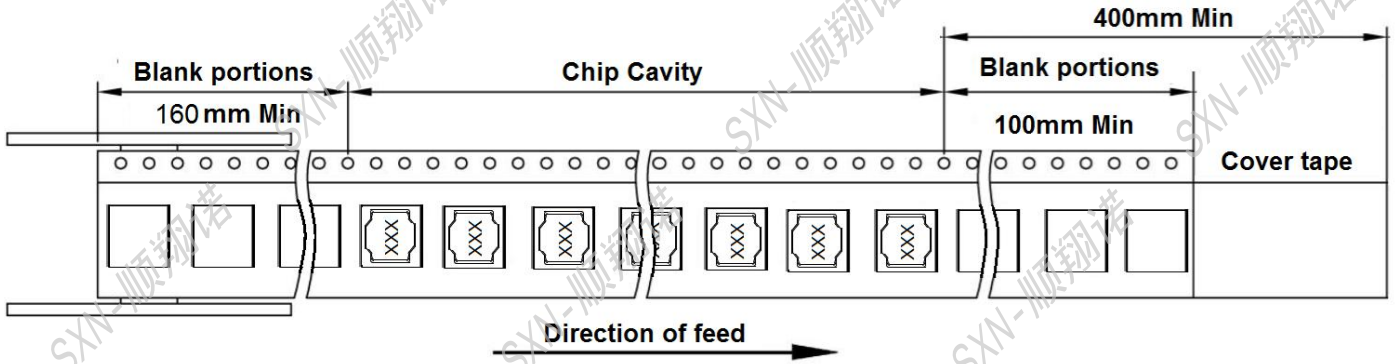

● Reel Dimensions (mm)

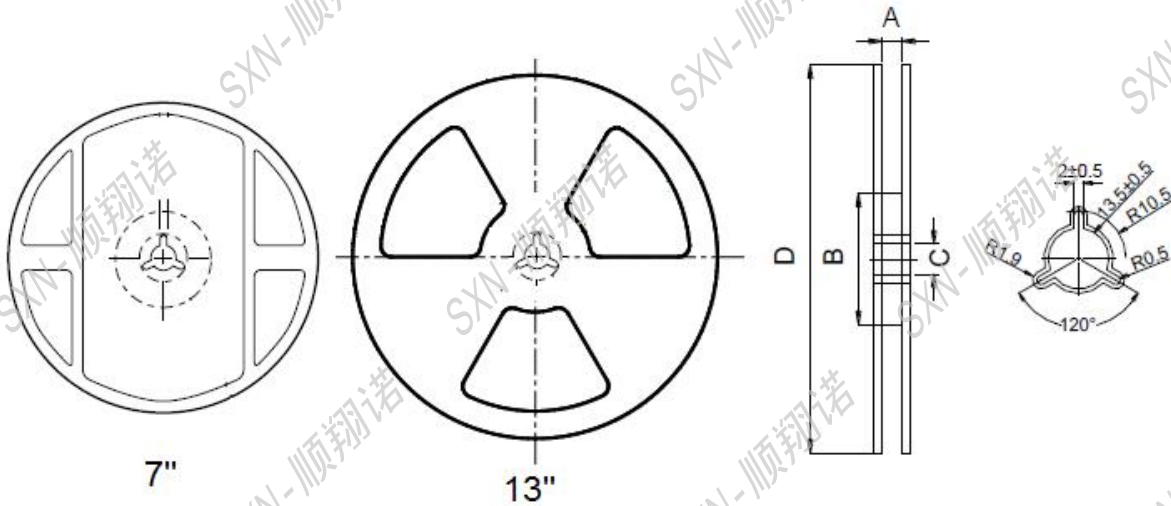

● Tape Dimension (mm)

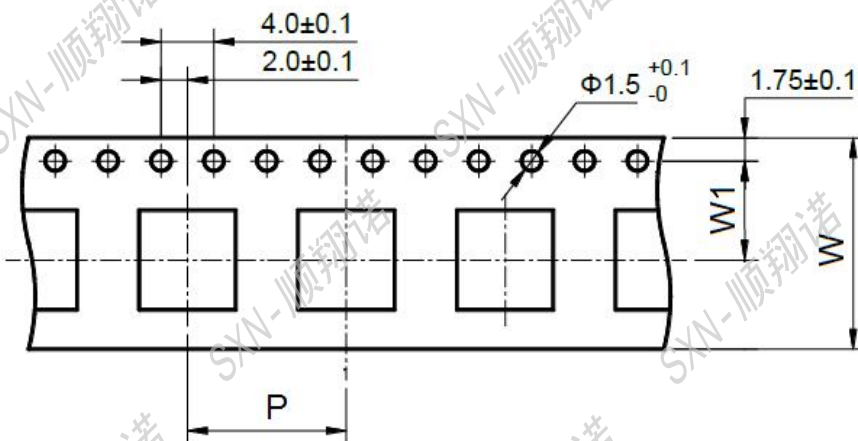

● Cover tape peel off condition

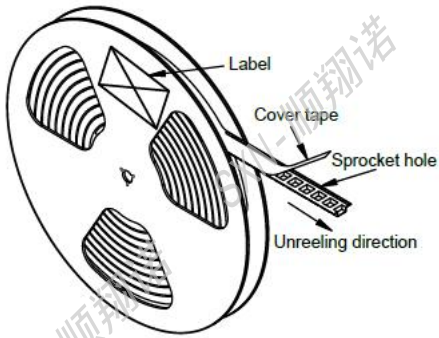

a) Cover tape peel force shall be 10 to 120g

b) Noodle strip peeling angle 165° to 180°

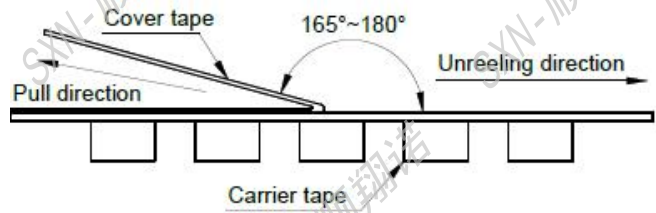

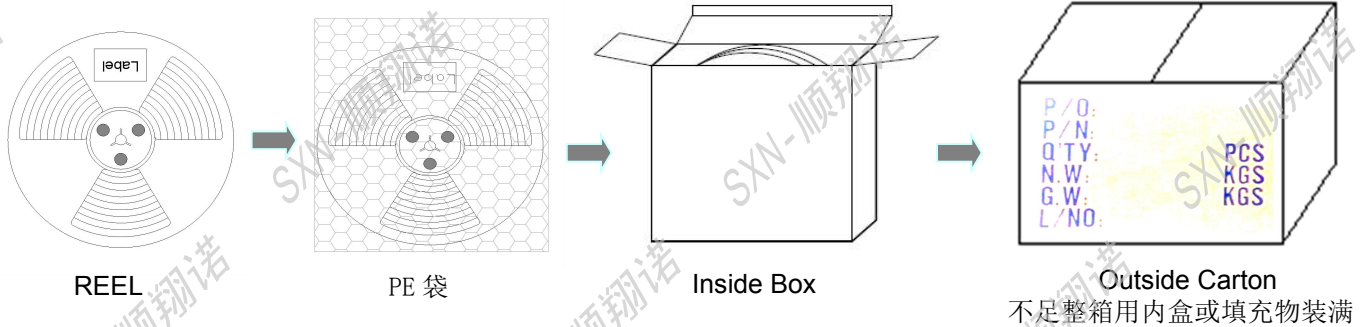

● Packing quantity



Part No.	Tape Dimension			Reel Dimensions				REEL (PCS)	Inside Box(PCS)	Outside Carton(PCS)
	W	P	W1	A	B	C	D			
SMNR201610	8	4	3.5	8.4	60	13	178	2000	20,000	80,000
SMNR252012	8	4	3.5	8.4	60	13	178	2000	20,000	80,000
SMNR3010	8	4	3.5	8.4	60	13	178	2000	20,000	80,000
SMNR3012	8	4	3.5	8.4	60	13	178	2000	20,000	80,000
SMNR3015	8	4	3.5	8.4	60	13	178	2000	20,000	80,000
SMNR4010	12	8	5.5	12.4	100	13	330	5000	20,000	80,000
SMNR4012	12	8	5.5	12.4	100	13	330	4500	18,000	72,000
SMNR4018	12	8	5.5	12.4	100	13	330	3000	12,000	48,000
SMNR4020	12	8	5.5	12.4	100	13	330	3000	12,000	48,000
SMNR4030	12	8	5.5	12.4	100	13	330	2000	8000	32,000
SMNR5020	12	8	5.5	12.4	100	13	330	3000	12,000	48,000
SMNR5030	12	8	5.5	12.4	100	13	330	2000	8000	32,000
SMNR5040	12	8	5.5	12.4	100	13	330	1500	6000	24,000
SMNR6020	16	12	7.5	16.4	100	13	330	3000	9000	36,000
SMNR6028	16	12	7.5	16.4	100	13	330	2000	6000	24,000
SMNR6045	16	12	7.5	16.4	100	13	330	1000	3000	12,000
SMNR8040	16	12	7.5	16.4	100	13	330	1000	3000	12,000
SMNR8060	16	12	7.5	16.4	100	13	330	800	2400	9600

◆可靠性测试:

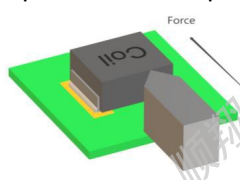
Reliability Testing:

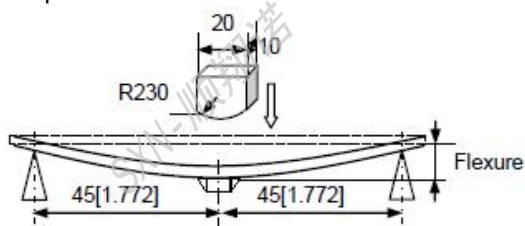
Items	Requirements	Test Methods and Remarks
Terminal Strength Reference documents: GB/T 2423.60-2008 端子强度(SMT)	1. Pulling test: Define: A: sectional area of terminal $A \leq 8\text{mm}^2$ force $\geq 5\text{N}$ time: 30sec $8\text{mm}^2 < A \leq 20\text{mm}^2$ force $\geq 10\text{N}$ time: 10sec $20\text{mm}^2 < A$ force $\geq 20\text{N}$ time: 10sec 2. Solder paste thickness: 0.12mm 3. Meet the above requirements without any loose terminal	Solder the inductor to the testing jig using leadfree solder. Then apply a force in the Keep time: $10 \pm 1\text{s}$ Speed: 1.0mm/s. 
Terminal Strength Reference documents: GB/T 2423.60-2008 端子强度(DIP)	1. Terminal diameter (d) mm $0.35 < d \leq 0.50$ Applied force: 5N Duration: 10sec 2. Terminal diameter (d) mm $0.50 < d \leq 0.80$ Applied force: 10N Duration: 10sec 3. Terminal diameter (d) mm $0.80 < d \leq 1.25$ Applied force: 20N Duration: 10sec 4. Terminal diameter (d) mm $D > 1.25$ Applied force: 40N Duration: 10sec 5. Meet the above requirements without any loose terminal.	Pull Force: the force shall be applied gradually to the terminal and then maintained for 10 seconds. 
Resistance to Flexure JIS C 5321:1997 抗弯曲性试验	1. No visible mechanical damage.	1. Solder the inductor to the test jig (glass epoxy board) 2. shown in Using a leadfree solder. Then apply a force in the direction shown 3. Flexure: 2mm. 4. Pressurizing Speed: 0.5mm/sec. 5. Keep time: 30 sec. 
Dropping Reference documents: GB/T 2423.7-2018 落下试验	1. No case deformation or change in appearance. 2. No short and no open.	1. Drop the packaged products from 1m high in 1 angle, 3 ridges and 6 surfaces, twice in each direction.
Solderability Reference documents: GB/T 2423.28-2005 可焊性试验	1. No visible mechanical damage. 2. Wetting shall exceed 75% coverage for 3. Terminals must have 95% minimum solder coverage	1. Solder temperature: $240 \pm 2^\circ\text{C}$ 2. Duration: 3 sec. 3. Solder: Sn/3.0Ag/0.5Cu. 4. Flux: 25% Resin and 75% ethanol in weight

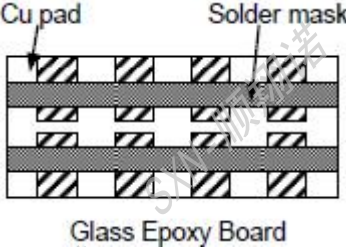
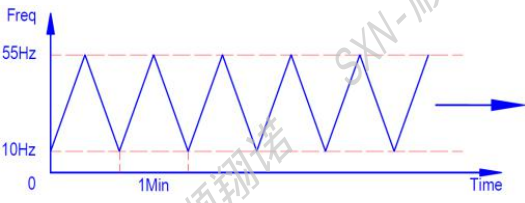
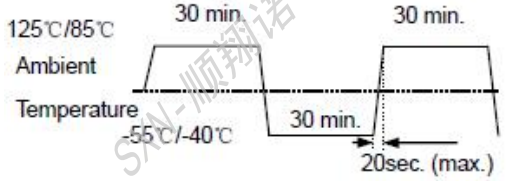
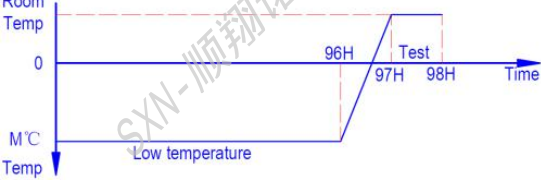
Items	Requirements	Test Methods and Remarks
<p>Vibration</p> <p>Reference documents: GB/T 2423.10-2019</p> <p>振動試驗</p>	<p>1.No visible mechanical damage.</p> <p>2. Inductance change: Within $\pm 10\%$.</p> <p>3. Q factor change: Within $\pm 20\%$.</p> 	<p>1.Solder the inductor to the testing jig (glass epoxy boardshown in) using leadfree solder.</p> <p>2.The inductor shall be subjected to a simple harmonic motion having total amplitude of 1.5mm, the frequency being varied uniformly between the approximate limits of 10 and 55 Hz.</p> <p>3.The frequency range from 10 to 55 Hz and return to 10 Hz shall be traversed in approximately 1 minute. This motion shall be applied for a period of 2 hours in each 3 mutually perpendicular directions(total of 6 hours).</p> 
<p>Thermal Shock</p> <p>Reference documents: GB/T 2423.22-2012</p> <p>Method Na</p> <p>冷热冲击试验</p>	<p>1.No visible mechanical damage.</p> <p>2. Inductance change: Within $\pm 10\%$.(Mn-Zn: Within $\leq 30\%$)</p> <p>3. Q factor change: Within $\pm 20\%$.</p>	<p>1.Start at (85~125℃) for T time, rush to (-55~40℃) for T time as one cycle, go through 100 cycles.</p> <p>2.Transforming interval: Max. 20 sec.</p> <p>3.Tested cycle: 100 cycles.</p> <p>4.The chip shall be stabilized at normal condition for 1~2 hours</p> 
<p>Low temperature Storage</p> <p>Reference documents: GB/T 2423.1-2008</p> <p>Method Ab</p> <p>低温储存试验</p>	<p>1.No visible mechanical damage.</p> <p>2. Inductance change: Within $\pm 10\%$.(Mn-Zn: Within $\leq 30\%$)</p> <p>3. Q factor change: Within $\pm 20\%$.</p>	<p>1. Temperature: M(-55~-40$\pm 2^\circ\text{C}$)</p> <p>2. Duration: 96± 2 hours</p> <p>3. The chip shall be stabilized at normal condition for 1~2 hours before measuring.</p> 

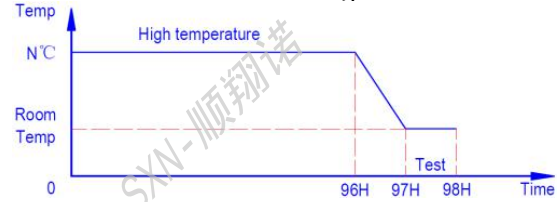
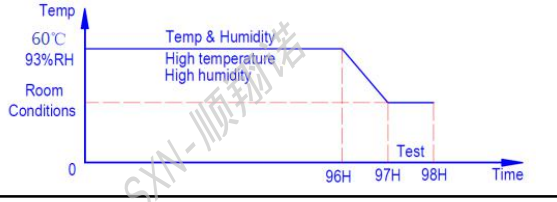
Items	Requirements	Test Methods and Remarks
High temperature Storage Reference documents: GB/T 2423.2-2008 Method Bb 高温储存试验	1.No visible mechanical damage. 2. Inductance change: Within $\pm 10\%$.(Mn-Zn: Within $\cong 30\%$) 3.Q factor change: Within $\pm 20\%$.	1.Temperature:N($125\sim 85\pm 2^\circ\text{C}$). 2.Duration: 96 \pm 2 hours 3.The chip shall be stabilized at normal condition for 1~2 hours before measuring. 
Damp Heat (Steady States) Reference documents: GB/T 2423.3-2016 恒定湿热试验	1.No visible mechanical damage. 2. Inductance change: Within $\pm 10\%$.(Mn-Zn: Within $\cong 30\%$) 3.Q factor change: Within $\pm 20\%$.	1.Temperature: $60\pm 2^\circ\text{C}$ 2.Humidity: 90% to 95% RH. 3.Duration: 96 \pm 2 hours. 4.The chip shall be stabilized at normal condition for 1~2 hours before measuring. 
Heat endurance of Reflow soldering Reference documents: GJB 360B-2009 回流焊耐热性试验	1.No significant defects in appearance. 2. $\Delta L/L \cong 10\%$ (Mn-Zn: $\Delta L/L \cong 30\%$) 3. $\Delta Q/Q \cong 30\%$ (SMD series only) 4. $\Delta DCR/DCR \cong 10\%$	1.Refer to the above reflow curve and go through the reflow for twice. 2.The peak temperature : $260\pm 0/-5^\circ\text{C}$
Resistance to solvent test Reference documents: IEC 68-2-45:1993 耐溶剂性试验	No case deformation or change in appearance or obliteration of marking	To dip parts into IPA solvent for 5 ± 0.5 Min, then drying them at room temp for 5Min, at last , to brushing making 10 times.
Overload test Reference documents: JIS C5311-6.13 过负荷试验	1.During the test no smoke, no peculiar, smell, no fire 2.The characteristic is normal after test	Apply twice as rated current for 5 minutes.
voltage resistance test Reference documents: MIL-STD-202G Method 301 绝缘耐压测试	1.During the test no breakdown 2.The characteristic is normal after test	1. For parts with two coils 2. DC1000V, Current: 1mA, Time: 1Min. 3. Refer to catalogue of specific products

◆ 推荐回流焊温度曲线

Recommended reflow soldering curve:

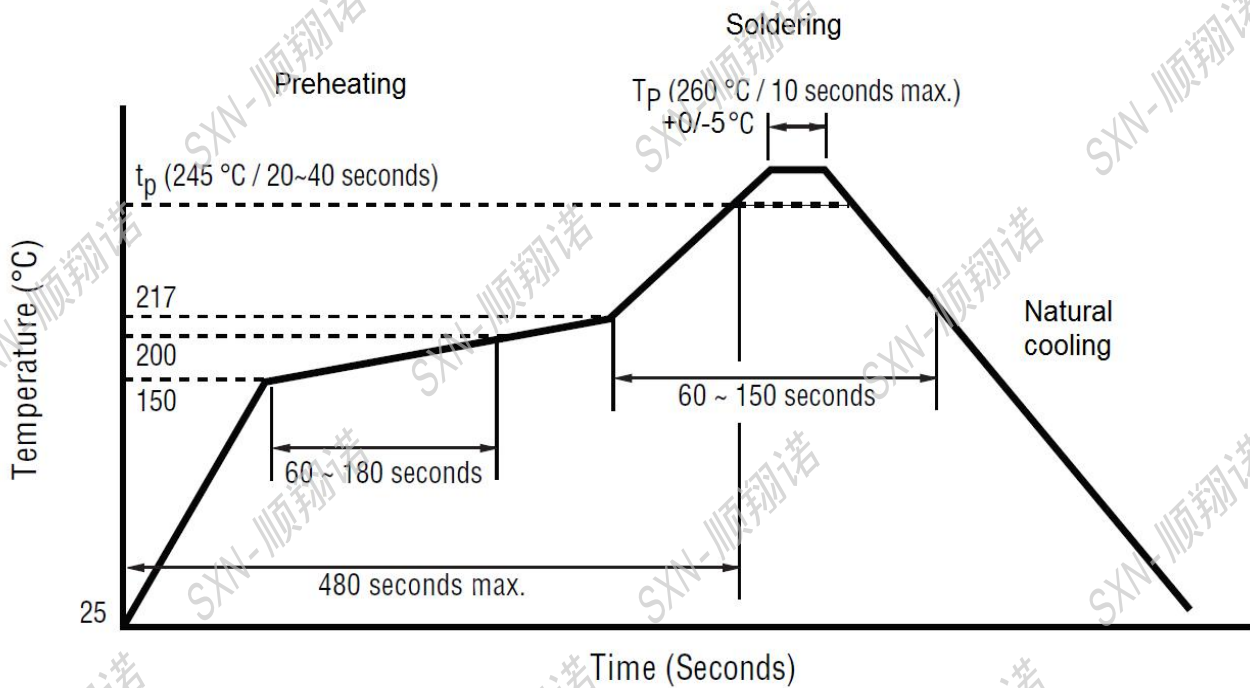

The recommended reflow conditions as above graph, is set according to our soldering equipment. DUE to various manufactures may have different reflow soldering equipment, products, process conditions, set methods. And so on, when setting the reflow conditions, Please adjust and confirm according to users' environment/equipment.

使用注意事项



REMINDERS FOR USING THESE PRODUCTS

- 保存时间为12 个月以内，保存条件（温度5~40°C以下、湿度35 ~ 66%RH 以下），需充分注意。若超过保存时间，端子电极的可焊性将可能老化。

The storage period is within 12 months. Be sure to follow the storage conditions (temperature: 5~40°C, humidity: 35 to 65% RH or less). If the storage period elapses, the soldering of the terminal electrodes may deteriorate.

- 请勿在气体腐蚀环境（盐、酸、碱等）下使用和保存。

Do not use or store in locations where there are conditions such as gas corrosion (salt, acid, alkali, etc.).

- 手上的油脂会导致可焊性降低，应避免用手直接接触端子。

Don't touch electrodes directly with bare hands as oil secretions may inhibit soldering. Always ensure optimum conditions for soldering.

- 请小心轻拿轻放，避免由于产品的跌落或取出不当而导致的损坏。

Please always handle products carefully to prevent any damage caused by dropping down or inappropriate removing.

- 端子过度弯曲会导致断线，请不要过度弯曲端子。

Don't bend the terminals with excessive stress in case of any wire fracture.

- 不要清洗产品，如需要清洗时请联系我司。

Don't rinse coils by yourself and please contact SXN if necessary.

- 请勿将本产品靠近磁铁或带有磁力的物体

Don't expose the products to magnets or magnetic fields

- 在实施焊接前，请务必进行预热。预热温度与焊接温度及芯片温度的温度差要在150°C 以内。

Before soldering, be sure to preheat components. The preheating temperature should be set so that the temperature difference between the solder temperature and chip temperature does not exceed 150°C.

- 安装后的焊接修正应在规格书规定的条件范围内。若加热过度可能导致短路、性能降低、寿命减少。

Soldering corrections after mounting should be within the range of the conditions determined in the specifications. If overheated, a short circuit, performance deterioration, or lifespan shortening may occur.

- 装置会因通电而自我发热（温度上升），因此在热设计方面需留有充分余地。

Self heating (temperature increase) occurs when the power is turned ON, so the tolerance should be sufficient for the set thermal design.

- 非磁屏蔽型在基板设计时需注意配置线圈，受到电磁干扰可能会导致误动作。

Carefully lay out the coil for the circuit board design of the non-magnetic shield type. A malfunction may occur due to magnetic interference.

X-ON Electronics

Largest Supplier of Electrical and Electronic Components

Click to view similar products for [Fixed Inductors](#) category:

Click to view products by [SXN](#) manufacturer:

Other Similar products are found below :

[CR32NP-151KC](#) [CR32NP-180KC](#) [CR32NP-181KC](#) [CR32NP-1R5MC](#) [CR32NP-390KC](#) [CR32NP-3R9MC](#) [CR32NP-680KC](#) [CR32NP-820KC](#) [CR32NP-8R2MC](#) [CR43NP-390KC](#) [CR43NP-560KC](#) [CR43NP-680KC](#) [CR54NP-181KC](#) [CR54NP-470LC](#) [CR54NP-820KC](#) [CR54NP-8R5MC](#) [70F224AI](#) [MGDQ4-00004-P](#) [MHL1ECTTP18NJ](#) [MHQ1005P10NJ](#) [MHQ1005P1N0S](#) [MHQ1005P2N4S](#) [MHQ1005P3N6S](#) [MHQ1005P5N1S](#) [MHQ1005P8N2J](#) [PE-51506NL](#) [PE-53601NL](#) [PE-53602NL](#) [PE-53630NL](#) [PE-53824SNLT](#) [PE-92100NL](#) [PG0434.801NLT](#) [PG0936.113NLT](#) [9220-20](#) [9310-16](#) [PM06-2N7](#) [PM06-39NJ](#) [A01TK](#) [1206CS-471XJ](#) [HC2LP-R47-R](#) [HC2-R47-R](#) [HC3-2R2-R](#) [HCF1305-3R3-R](#) [1206CS-151XG](#) [RCH664NP-140L](#) [RCH664NP-4R7M](#) [RCH8011NP-221L](#) [RCP1317NP-332L](#) [RCP1317NP-391L](#) [RCR1010NP-470M](#)