

# MINIATURE SMD CHIP CHOKE COILS

闭磁路贴片电感

Wire Wound SMD Power Inductors

Operating Temp:-20℃ ~ 120℃



**特征:**

- 轻便薄小
- 大电流低直流阻抗
- 直接在磁芯上金属化电极，抗跌落冲击强，经久耐用
- 闭合磁路结构设计，漏磁少，抗 EMI 能力强
- 省空间，更省电

**FEATURES:**

- Compact and thin.
- Large Current and Low DCR.
- Metallization on Ferrite Core results in excellent shock resistance and damage-free durability
- Closed magnetic circuit design reduces leakage flux and Electro Magnetic Interference (EMI)
- Takes up less PCB real estate and save more power

**用途:**

- 广泛应用于 LED 背光板、平板电视、蓝光 DVD 机顶盒、笔记本电脑、台式电脑、服务器、显卡、便携式游戏机、个人导航系统、多媒体、汽车产品、通信设备、直流转换。

**APPLICATIONS**

- LED backlight、Flat-screen TVs, blue-ray disc recorders, set top box、Notebooks, desktop computers, servers, graphic cards、Portable gaming devices, personal navigation systems, personal multimedia devices, Automotive systemsTelecomm base station、DC-DC converter

**产品型号:**

**PRODUCT IDENTIFICATION**

**SMNR                      8040                      470                      M                      T**

①                                      ②                                      ③                                      ④                                      ⑤

①

类型 Type	
SMNR	闭磁路贴片电感 Unshielded SMT Power Inductors

②

外形尺寸(LxH) (mm) External Dimensions (LxWxH) (mm)	
8040	8.0X8.0x4.0

③

Inductance
47 uH

④

Tolerance	
J:±5%,K: ±10%, L: ±15%	
M: ±20%,P: ±25%, N: ±30%	

⑤

包装 Packing	
B	散装 Bulk Package
T	编带Tape & Reel

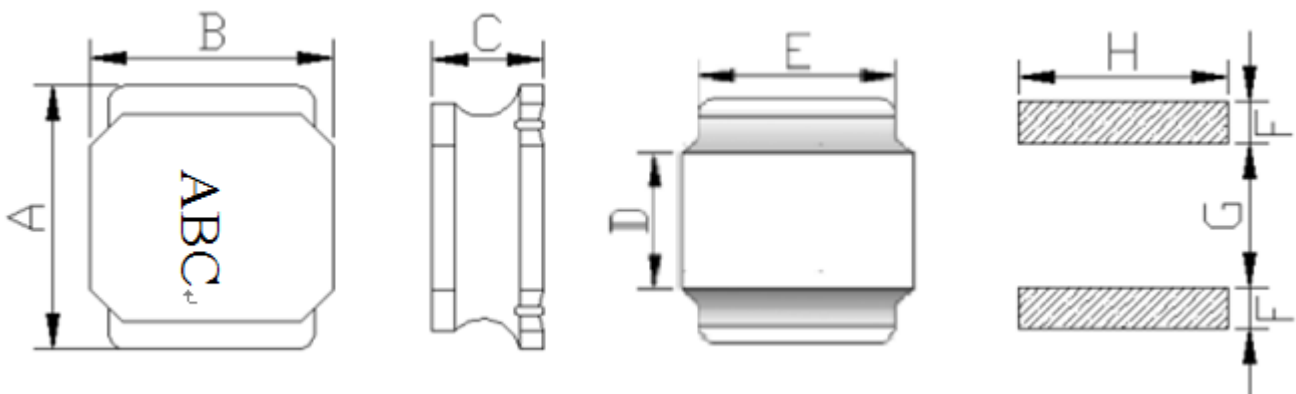

# MINIATURE SMD CHIP CHOKE COILS

Part No	A	B	C max	D	E	F Typ	G Typ	H Typ
SMNR3010	3.0±0.3	3.0±0.3	1.0	1.5±0.2	2.5±0.2	0.8	1.5	2.7
SMNR3012	3.0±0.3	3.0±0.3	1.2	1.5±0.2	2.5±0.2	0.8	1.5	2.7
SMNR3015	3.0±0.3	3.0±0.3	1.5	1.5±0.2	2.5±0.2	0.8	1.5	2.7
SMNR4010	4.0±0.3	4.0±0.3	1.0	2.1±0.2	3.3±0.2	1.1	1.9	3.7
SMNR4012	4.0±0.3	4.0±0.3	1.2	2.1±0.2	3.3±0.2	1.1	1.9	3.7
SMNR4018	4.0±0.3	4.0±0.3	1.8	2.1±0.2	3.3±0.2	1.1	1.9	3.7
SMNR4020	4.0±0.3	4.0±0.3	2.0	2.1±0.2	3.3±0.2	1.1	1.9	3.7
SMNR4030	4.0±0.3	4.0±0.3	3.0	2.1±0.2	3.3±0.2	1.1	1.9	3.7
SMNR5020	4.0±0.3	4.0±0.3	2.0	2.5±0.2	4.0±0.2	1.4	2.3	4.2
SMNR5030	4.0±0.3	4.0±0.3	3.0	2.5±0.2	4.0±0.2	1.4	2.3	4.2
SMNR5040	4.0±0.3	4.0±0.3	4.0	2.5±0.2	4.0±0.2	1.4	2.3	4.2
SMNR6020	6.0±0.3	6.0±0.3	2.0	2.9±0.3	4.9±0.3	1.7	2.8	5.7
SMNR6028	6.0±0.3	6.0±0.3	3.0	2.9±0.3	4.9±0.3	1.7	2.8	5.7
SMNR6045	6.0±0.3	6.0±0.3	4.5	2.9±0.3	4.9±0.3	1.7	2.8	5.7
SMNR8040	8.0±0.3	8.0±0.3	4.0	4.0±0.3	6.3±0.3	2.2	3.8	7.5

## SMNR3010 Series

Part No.	Inductance (uH)			DCR (OHM) Max	Rated DC Current (Amp)Max
	Nominal Value	Tole.	Test Freq.		
SMNR3010 -1R0N	1.0	N	100KHz/1.0v	0.07	1.30
SMNR3010 -1R5N	1.5	N	100KHz/1.0v	0.08	1.20
SMNR3010 -2R2N	2.2	N	100KHz/1.0v	0.10	1.10
SMNR3010 -3R3N	3.3	N	100KHz/1.0v	0.14	0.87
SMNR3010 -4R7N	4.7	N	100KHz/1.0v	0.19	0.75
SMNR3010 -6R8N	6.8	N	100KHz/1.0v	0.30	0.62
SMNR3010 -100M	10	M	100KHz/1.0v	0.45	0.50
SMNR3010 -150M	15	M	100KHz/1.0v	0.74	0.40
SMNR3010 -220M	22	M	100KHz/1.0v	1.03	0.35
SMNR3010 -330M	33	M	100KHz/1.0v	1.55	0.26
SMNR3010 -470M	47	M	100KHz/1.0v	2.05	0.22

## SMNR3012 Series

Part No.	Inductance (uH)			DCR (OHM) Max	Rated DC Current (Amp)Max
	Nominal Value	Tole.	Test Freq.		
SMNR3012 -1R0N	1.0	N	100KHz/1.0v	0.05	1.50
SMNR3012 -1R5N	1.5	N	100KHz/1.0v	0.06	1.36
SMNR3012 -2R2N	2.2	N	100KHz/1.0v	0.08	1.10
SMNR3012 -3R3N	3.3	N	100KHz/1.0v	0.10	0.91
SMNR3012 -4R7N	4.7	N	100KHz/1.0v	0.13	0.77
SMNR3012 -6R8N	6.8	N	100KHz/1.0v	0.19	0.67
SMNR3012 -100M	10	M	100KHz/1.0v	0.29	0.54
SMNR3012 -150M	15	M	100KHz/1.0v	0.45	0.44
SMNR3012 -220M	22	M	100KHz/1.0v	0.63	0.38
SMNR3012 -330M	33	M	100KHz/1.0v	1.03	0.31

# MINIATURE SMD CHIP CHOKE COILS

## SMNR3015 Series

Part No.	Inductance (uH)			DCR (OHM) Max	Rated DC Current (Amp)Max
	Nominal Value	Tole.	Test Freq.		
SMNR3015 -1R0N	1.0	N	100KHz/1.0v	0.03	2.10
SMNR3015 -1R5N	1.5	N	100KHz/1.0v	0.04	1.80
SMNR3015 -2R2N	2.2	N	100KHz/1.0v	0.06	1.48
SMNR3015 -3R3N	3.3	N	100KHz/1.0v	0.08	1.21
SMNR3015 -4R7N	4.7	N	100KHz/1.0v	0.12	1.02
SMNR3015 -6R8N	6.8	N	100KHz/1.0v	0.16	0.87
SMNR3015 -100M	10	M	100KHz/1.0v	0.23	0.70
SMNR3015 -150M	15	M	100KHz/1.0v	0.36	0.56
SMNR3015 -220M	22	M	100KHz/1.0v	0.52	0.47
SMNR3015 -330M	33	M	100KHz/1.0v	0.84	0.39
SMNR3015 -470M	47	M	100KHz/1.0v	1.34	0.32

## MNR4010 Series

Part No.	Inductance (uH)			DCR (OHM) Max	Rated DC Current (Amp)Max
	Nominal Value	Tole.	Test Freq.		
SMNR4010 -1R0N	1.0	N	100KHz/1.0v	0.070	2.00
SMNR4010 -2R2N	2.2	N	100KHz/1.0v	0.105	1.20
SMNR4010 -3R3N	3.3	N	100KHz/1.0v	0.125	1.10
SMNR4010 -4R7N	4.7	N	100KHz/1.0v	0.26	0.95
SMNR4010 -6R8N	6.8	N	100KHz/1.0v	0.27	0.80
SMNR4010 -100M	10	M	100KHz/1.0v	0.380	0.62
SMNR4010 -150M	15	M	100KHz/1.0v	0.550	0.54
SMNR4010 -220M	22	M	100KHz/1.0v	0.700	0.45
SMNR4010 -330M	33	M	100KHz/1.0v	0.780	0.28
SMNR4010 -470M	47	M	100KHz/1.0v	0.990	0.16

## SMNR4012 Series

Part No.	Inductance (uH)			DCR (OHM) Max	Rated DC Current (Amp)Max
	Nominal Value	Tole.	Test Freq.		
SMNR4012 -1R0N	1.0	N	100KHz/1.0v	0.06	2.50
SMNR4012 -2R2N	2.2	N	100KHz/1.0v	0.100	1.65
SMNR4012 -3R3N	3.3	N	100KHz/1.0v	0.135	1.20
SMNR4012 -4R7N	4.7	N	100KHz/1.0v	0.170	1.05
SMNR4012 -6R8N	6.8	N	100KHz/1.0v	0.240	0.90
SMNR4012 -100M	10	M	100KHz/1.0v	0.330	0.74
SMNR4012 -150M	15	M	100KHz/1.0v	0.40	0.56
SMNR4012 -220M	22	M	100KHz/1.0v	0.700	0.51
SMNR4012 -330M	33	M	100KHz/1.0v	0.960	0.40
SMNR4012 -470M	47	M	100KHz/1.0v	1.350	0.35

# MINIATURE SMD CHIP CHOKE COILS

## SMNR4018 Series

Part No.	Inductance (uH)			DCR (OHM) Max	Rated DC Current (Amp)Max
	Nominal Value	Tole.	Test Freq.		
SMNR4018 -1R0N	1.0	N	100KHz/1.0v	0.030	4.80
SMNR4018 -1R5N	1.5	N	100KHz/1.0v	0.036	3.35
SMNR4018 -2R2N	2.2	N	100KHz/1.0v	0.550	2.70
SMNR4018 -3R3N	3.3	N	100KHz/1.0v	0.880	2.45
SMNR4018 -4R7N	4.7	M	100KHz/1.0v	0.115	1.70
SMNR4018 -6R8N	6.8	M	100KHz/1.0v	0.140	1.45
SMNR4018 -100M	10	M	100KHz/1.0v	0.230	1.30
SMNR4018 -150M	15	M	100KHz/1.0v	0.320	0.94
SMNR4018 -220M	22	M	100KHz/1.0v	0.400	0.80
SMNR4018 -330M	33	M	100KHz/1.0v	0.660	0.56
SMNR4018 -470M	47	M	100KHz/1.0v	0.760	0.50
SMNR4018 -680M	68	M	100KHz/1.0v	1.280	0.47
SMNR4018 -101M	100	M	100KHz/1.0v	2.200	0.40
SMNR4018 -151M	150	M	100KHz/1.0v	3.000	0.31

## SMNR4020 Series

Part No.	Inductance (uH)			DCR (OHM) Max	Rated DC Current (Amp)Max
	Nominal Value	Tole.	Test Freq.		
SMNR4020 -1R0N	1.0	M	100KHz/1.0v	0.03	4.00
SMNR4020 -2R2N	2.2	M	100KHz/1.0v	0.06	2.70
SMNR4020 -3R3N	3.3	M	100KHz/1.0v	0.07	2.00
SMNR4020 -4R7N	4.7	M	100KHz/1.0v	0.09	1.70
SMNR4020 -6R8N	6.8	M	100KHz/1.0v	0.11	1.45
SMNR4020 -100M	10	M	100KHz/1.0v	0.18	1.20
SMNR4020 -150M	15	M	100KHz/1.0v	0.25	0.94
SMNR4020 -220M	22	M	100KHz/1.0v	0.36	0.80
SMNR4020 -330M	33	M	100KHz/1.0v	0.53	0.65
SMNR4020 -470M	47	M	100KHz/1.0v	0.65	0.57
SMNR4020 -680M	68	M	100KHz/1.0v	1.00	0.47

# MINIATURE SMD CHIP CHOKE COILS

## SMNR4030 Series

Part No.	Inductance (uH)			DCR (OHM) Max	Rated DC Current (Amp)Max
	Nominal Value	Tole.	Test Freq.		
SMNR4030 -1R0N	1.0	N	100KHz/1.0v	0.018	5.26
MNR4030 -1R5N	1.5	N	00KHz/1.0v	0.026	4.85
SMNR4030 -2R2N	2.2	N	100KHz/1.0v	0.039	4.40
SMNR4030 -3R3N	3.3	N	100KHz/1.0v	0.050	3.30
SMNR4030 -4R7N	4.7	N	100KHz/1.0v	0.076	2.90
SMNR4030 -6R8N	6.8	N	100KHz/1.0v	0.115	2.75
SMNR4030 -8R2N	8.2	N	100KHz/1.0v	0.122	2.10
SMNR4030 -100M	10	M	100KHz/1.0v	0.130	1.95
SMNR4030 -120M	12	M	100KHz/1.0v	0.172	1.70
SMNR4030 -150M	15	M	100KHz/1.0v	0.230	1.65
SMNR4030 -220M	22	M	100KHz/1.0v	0.290	1.30
SMNR4030 -330M	33	M	100KHz/1.0v	0.420	1.10
SMNR4030 -470M	47	M	100KHz/1.0v	0.570	0.95
SMNR4030 -680M	68	M	100KHz/1.0v	1.100	0.72
SMNR4030 -820M	82	M	100KHz/1.0v	1.280	0.66
SMNR4030 -101M	100	M	100KHz/1.0v	1.480	0.60
SMNR4030 -121M	120	M	100KHz/1.0v	1.700	0.55

## SMNR5020 Series

Part No.	Inductance (uH)			DCR (OHM) Max	Rated DC Current (Amp)Max
	Nominal Value	Tole.	Test Freq.		
SMNR5020 -1R0N	1.0	N	100KHz/1.0v	0.025	4.10
SMNR5020 -1R5N	1.5	N	00KHz/1.0v	0.032	3.80
SMNR5020 -2R2N	2.2	N	100KHz/1.0v	0.040	3.20
SMNR5020 -3R3N	3.3	N	100KHz/1.0v	0.054	2.55
SMNR5020 -4R7N	4.7	N	100KHz/1.0v	0.074	2.40
SMNR5020 -6R8N	6.8	N	100KHz/1.0v	0.107	2.05
SMNR5020 -8R2N	8.2	N	100KHz/1.0v	0.125	1.85
SMNR5020 -100M	10	M	100KHz/1.0v	0.140	1.70
SMNR5020 -120M	12	M	100KHz/1.0v	0.180	1.50
SMNR5020 -150M	15	M	100KHz/1.0v	0.210	1.35
SMNR5020 -220M	22	M	100KHz/1.0v	0.290	1.15
SMNR5020 -330M	33	M	100KHz/1.0v	0.500	0.95
SMNR5020 -470M	47	M	100KHz/1.0v	0.670	0.77
SMNR5020 -680M	68	M	100KHz/1.0v	1.050	0.72
SMNR5020 -820M	82	M	100KHz/1.0v	1.280	0.66
SMNR5020 -101M	100	M	100KHz/1.0v	1.480	0.57
SMNR5020 -121M	120	M	100KHz/1.0v	1.700	0.49

# MINIATURE SMD CHIP CHOKE COILS

## SMNR5040 Series

Part No.	Inductance (uH)			DCR (OHM) Max	Rated DC Current (Amp)Max
	Nominal Value	Tole.	Test Freq.		
SMNR5040 -1R0N	1.0	N	100KHz/1.0v	0.015	4.10
SMNR5040 -1R5N	1.5	N	100KHz/1.0v	0.020	6.50
SMNR5040 -2R2N	2.2	N	100KHz/1.0v	0.025	4.90
SMNR5040 -3R3N	3.3	N	100KHz/1.0v	0.031	3.95
SMNR5040 -4R7N	4.7	N	100KHz/1.0v	0.039	2.50
SMNR5040 -6R8N	6.8	N	100KHz/1.0v	0.056	2.90
SMNR5040 -8R2N	8.2	N	100KHz/1.0v	0.070	2.60
SMNR5040 -100M	10	M	100KHz/1.0v	0.082	2.35
SMNR5040 -120M	12	M	100KHz/1.0v	0.102	2.12
SMNR5040 -150M	15	M	100KHz/1.0v	0.115	2.00
SMNR5040 -220M	22	M	100KHz/1.0v	0.167	1.60
SMNR5040 -330M	33	M	100KHz/1.0v	0.244	1.30
SMNR5040 -470M	47	M	100KHz/1.0v	0.353	1.10
SMNR5040 -680M	68	M	100KHz/1.0v	0.520	0.90
SMNR5040 -820M	82	M	100KHz/1.0v	0.660	0.80
SMNR5040 -101M	100	M	100KHz/1.0v	0.728	0.75
SMNR5040 -121M	120	M	100KHz/1.0v	0.950	0.50

## SMNR6020 Series

Part No.	Inductance (uH)			DCR (OHM) Max	Rated DC Current (Amp)Max
	Nominal Value	Tole.	Test Freq.		
SMNR6020 -R68N	0.68	N	100KHz/1.0v	0.022	6.55
SMNR6020 -R82N	0.82	N	100KHz/1.0v	0.023	5.30
SMNR6020 -1R0N	1.0	N	100KHz/1.0v	0.026	4.15
SMNR6020 -1R5N	1.5	N	100KHz/1.0v	0.028	4.10
SMNR6020 -1R8N	1.8	N	100KHz/1.0v	0.036	4.05
SMNR6020 -2R2N	2.2	N	100KHz/1.0v	0.038	4.00
SMNR6020 -3R3N	3.3	N	100KHz/1.0v	0.045	3.15
SMNR6020 -3R9N	3.9	N	100KHz/1.0v	0.060	3.10
SMNR6020 -4R7N	4.7	N	100KHz/1.0v	0.075	3.00
SMNR6020 -5R6N	5.6	N	100KHz/1.0v	0.077	2.40
SMNR6020 -6R8N	6.8	N	100KHz/1.0v	0.100	2.20
SMNR6020 -8R2N	8.2	N	100KHz/1.0v	0.130	2.10
SMNR6020 -100M	10	M	100KHz/1.0v	0.135	1.75
SMNR6020 -120M	12	M	100KHz/1.0v	0.150	1.45
SMNR6020 -150M	15	M	100KHz/1.0v	0.188	1.20
SMNR6020 -180M	18	M	100KHz/1.0v	0.230	1.16
SMNR6020 -220M	22	M	100KHz/1.0v	0.260	1.05

# MINIATURE SMD CHIP CHOKE COILS

## SMNR6028 Series

Part No.	Inductance (uH)			DCR (OHM) Max	Rated DC Current (Amp)Max
	Nominal Value	Tole.	Test Freq.		
SMNR6028 -1R0N	1.0	N	100KHz/1.0v	0.013	5.75
SMNR6028 -1R5N	1.5	N	100KHz/1.0v	0.016	5.50
SMNR6028 -2R2N	2.2	N	100KHz/1.0v	0.026	5.10
SMNR6028 -3R3N	3.3	N	100KHz/1.0v	0.032	4.15
SMNR6028 -4R7N	4.7	N	100KHz/1.0v	0.039	3.00
SMNR6028 -6R2N	6.2	N	100KHz/1.0v	0.061	3.05
SMNR6028 -8R2N	8.2	N	100KHz/1.0v	0.071	2.30
SMNR6028 -100M	10	M	100KHz/1.0v	0.093	2.04
SMNR6028 -120M	12	M	100KHz/1.0v	0.104	1.80
SMNR6028 -150M	15	M	100KHz/1.0v	0.162	1.75
SMNR6028 -180M	18	M	100KHz/1.0v	0.169	1.52
SMNR6028 -220M	22	M	100KHz/1.0v	0.182	1.45
SMNR6028 -330M	33	M	100KHz/1.0v	0.240	1.35
SMNR6028 -390M	39	M	100KHz/1.0v	0.292	1.25
SMNR6028 -470M	47	M	100KHz/1.0v	0.400	1.15
SMNR6028 -680M	68	M	100KHz/1.0v	0.468	0.80
SMNR6028 -820M	82	M	100KHz/1.0v	0.650	0.75
SMNR6028 -101M	100	M	100KHz/1.0v	0.675	0.65

## SMNR6045 Series

Part No.	Inductance (uH)			DCR (OHM) Max	Rated DC Current (Amp)Max
	Nominal Value	Tole.	Test Freq.		
SMNR6045 -1R0N	1.0	N	100KHz/1.0v	0.014	9.85
SMNR6030 -1R5N	1.5	N	100KHz/1.0v	0.015	8.80
SMNR6045 -2R2N	2.2	N	100KHz/1.0v	0.018	6.75
SMNR6045 -3R3N	3.3	N	100KHz/1.0v	0.027	5.90
SMNR6045 -4R7N	4.7	N	100KHz/1.0v	0.033	4.97
SMNR6045 -6R8N	6.8	N	100KHz/1.0v	0.040	3.90
SMNR6045 -100M	10	M	100KHz/1.0v	0.062	3.20
SMNR6045 -150M	15	M	100KHz/1.0v	0.088	2.50
SMNR6045 -220M	22	M	100KHz/1.0v	0.115	2.05
SMNR6045 -330M	33	M	100KHz/1.0v	0.178	1.65
SMNR6045-470M	47	M	100KHz/1.0v	0.260	1.40
SMNR6045-680M	68	M	100KHz/1.0v	0.375	1.20
SMNR6045-820M	82	M	100KHz/1.0v	0.440	1.05
SMNR6045-101M	100	M	100KHz/1.0v	0.562	0.95
SMNR6045-121M	120	M	100KHz/1.0v	0.628	0.85
SMNR6045-151M	150	M	100KHz/1.0v	0.750	0.80
SMNR6045-221M	220	M	100KHz/1.0v	1.050	0.70
SMNR6045-331M	330	M	100KHz/1.0v	1.650	0.57

# MINIATURE SMD CHIP CHOKE COILS

## SMNR8040 Series

Part No.	Inductance (uH)			DCR (OHM) Max	Rated DC Current (Amp)Max
	Nominal Value	Tole.	Test Freq.		
SMNR8040 -1R0N	1.0	N	100KHz/1.0v	0.010	9.85
SMNR8040 -1R5N	1.4	N	100KHz/1.0v	0.013	8.15
SMNR8040 -2R2N	2.2	N	100KHz/1.0v	0.015	7.10
SMNR8040 -3R3N	3.3	N	100KHz/1.0v	0.022	6.50
SMNR8040 -4R7N	4.7	N	100KHz/1.0v	0.024	5.9
SMNR8040 -6R8N	6.8	N	100KHz/1.0v	0.031	4.55
SMNR8040 -8R2N	8.2	N	100KHz/1.0v	0.033	4.20
SMNR8040 -100M	10	M	100KHz/1.0v	0.037	3.60
SMNR8040 -150M	15	M	100KHz/1.0v	0.061	2.95
SMNR8040 -180M	18	M	100KHz/1.0v	0.068	2.70
SMNR8040 -220M	22	M	100KHz/1.0v	0.089	2.40
SMNR8040 -270M	27	M	100KHz/1.0v	0.101	2.15
SMNR8040 -330M	33	M	100KHz/1.0v	0.126	2.05
SMNR8040 -390M	39	M	100KHz/1.0v	0.139	1.95
SMNR8040-470M	47	M	100KHz/1.0v	0.176	1.75
SMNR8040-680M	68	M	100KHz/1.0v	0.254	1.45
SMNR8040 -820M	82	M	100KHz/1.0v	0.292	1.30
SMNR8040-101M	100	M	100KHz/1.0v	0.377	1.15
SMNR8040 -121M	120	M	100KHz/1.0v	0.434	1.12
SMNR8040 -151M	150	M	100KHz/1.0v	0.553	1.10
SMNR8040 -221M	220	M	100KHz/1.0v	0.778	0.85
SMNR8040 -331M	330	M	100KHz/1.0v	1.155	0.68



## X-ON Electronics

Largest Supplier of Electrical and Electronic Components

*Click to view similar products for [Fixed Inductors](#) category:*

*Click to view products by [SXN](#) manufacturer:*

Other Similar products are found below :

[MLZ1608M6R8WTD25](#) [MLZ1608N6R8LT000](#) [MLZ1608N3R3LTD25](#) [MLZ1608N3R3LT000](#) [MLZ1608N150LT000](#)  
[MLZ1608M150WTD25](#) [MLZ1608M3R3WTD25](#) [MLZ1608M3R3WT000](#) [MLZ1608M150WT000](#) [MLZ1608A1R5WT000](#)  
[MLZ1608N1R5LT000](#) [B82432C1333K000](#) [PCMB053T-1R0MS](#) [PCMB053T-1R5MS](#) [PCMB104T-1R5MS](#) [CR32NP-100KC](#) [CR32NP-151KC](#) [CR32NP-180KC](#) [CR32NP-181KC](#) [CR32NP-1R5MC](#) [CR32NP-390KC](#) [CR32NP-3R9MC](#) [CR32NP-680KC](#) [CR32NP-820KC](#)  
[CR32NP-8R2MC](#) [CR43NP-390KC](#) [CR43NP-560KC](#) [CR43NP-680KC](#) [CR54NP-181KC](#) [CR54NP-470LC](#) [CR54NP-820KC](#) [CR54NP-8R5MC](#)  
[MGDQ4-00004-P](#) [MGDU1-00016-P](#) [MHL1ECTTP18NJ](#) [MHL1JCTTD12NJ](#) [PE-51506NL](#) [PE-53601NL](#) [PE-53630NL](#) [PE-53824SNLT](#) [PE-62892NL](#) [PE-92100NL](#) [PG0434.801NLT](#) [PG0936.113NLT](#) [PM06-2N7](#) [PM06-39NJ](#) [HC2LP-R47-R](#) [HC2-R47-R](#) [HC3-2R2-R](#) [HC8-1R2-R](#)