

MODEL TL-2450

TECHNICAL DATA

(Typical values @+25°C for batteries stored for one year or less)

■ Nominal capacity @ 0.5 mA, to 2V	0.55 Ah
■ Rated voltage	3.6 V
■ Maximum recommended continuous current	5 mA
■ Maximum pulse current capability	10 mA
■ Weight	8.8g (0.310 oz)
■ Volume	2.60 cc
■ Operating temperature range	-55°C to +85°C
■ Li metal content	approx. 0.2 g
■ U.L. Component Recognition MH 12193	

TADIRAN LITHIUM BATTERIES

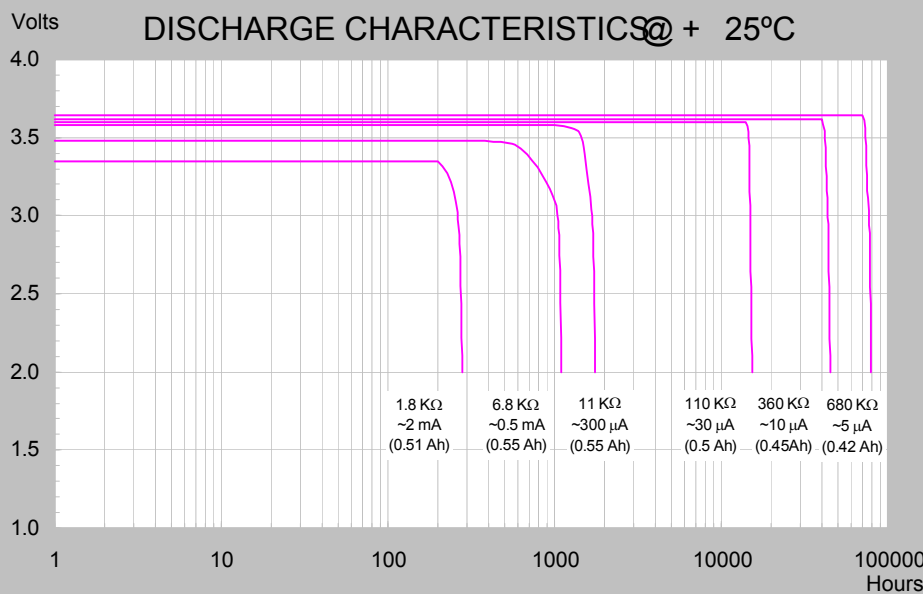
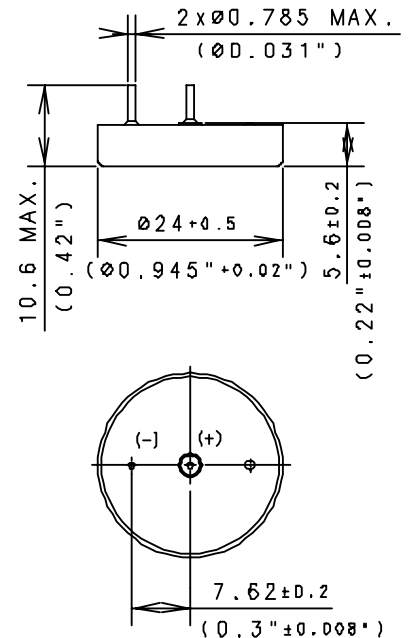

ADDITIONAL INFORMATION

SUFFIX- /P TIN PLATED NICKEL PINS
CATALOGUE NO.: 15-2450-41020

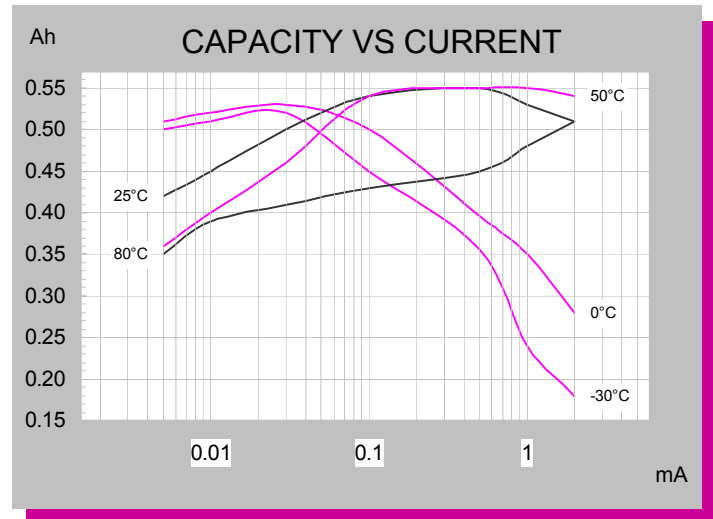
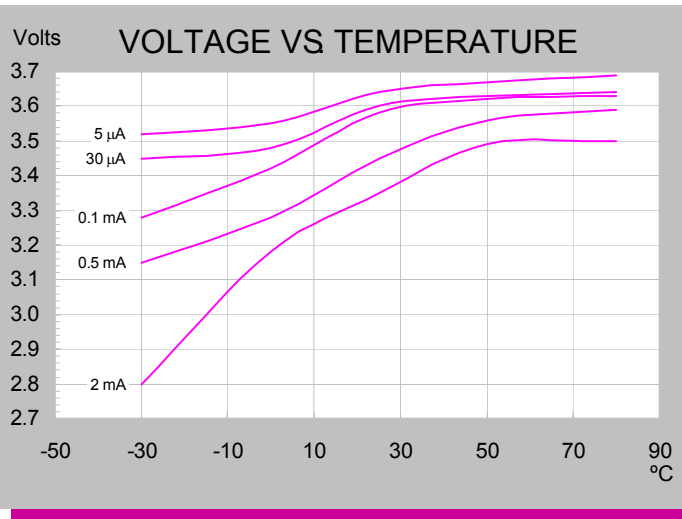

iXtra - Long Term High Performance

Note: Any presentations in this data sheet concerning performance are for information purpose only and are not construed as warranties either expressed or implied, of future performance. Rev. B 02/11 ECN 1502262

TL-2450

CELL FEATURES

- 3.6 V Primary lithium-thionyl chloride (Li-SOCl₂)
- Fast voltage recovery after long term storage and/or usage
- High energy density
- High and stable operating voltage
- Low self discharge rate
- 10 years shelf life
- Wafer construction
- Hermetic glass-to-metal-sealing
- Non-flammable electrolyte
- Non-restricted for transportation

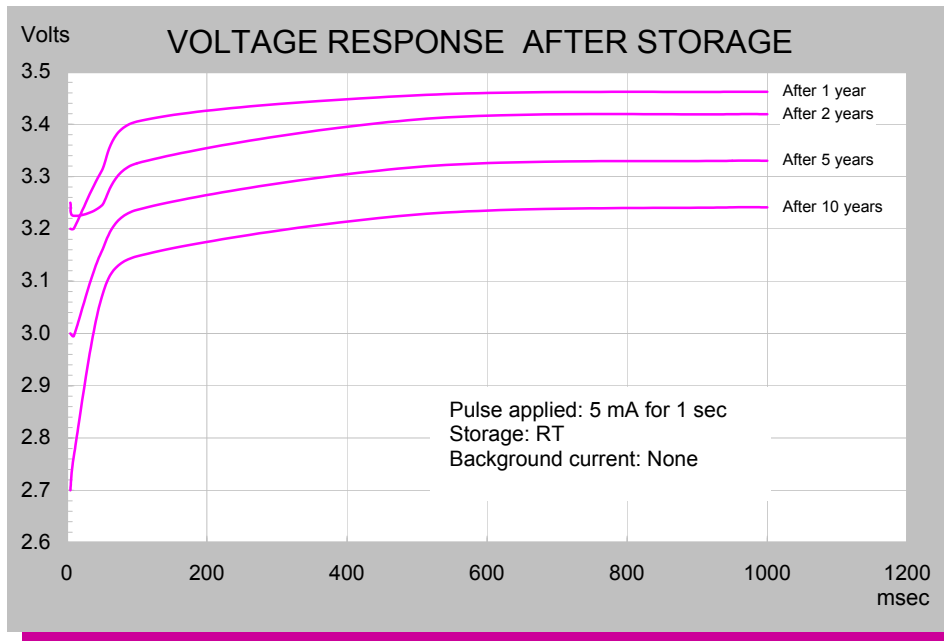

TADIRAN LITHIUM BATTERIES

MAIN APPLICATIONS

- Utility meters (elect., water & gas)
- Automatic meter reading
- RF systems
- Sensors & monitoring systems
- Tracking systems
- Wireless security systems
- Automotive electronics
- Industrial electronics
- Ultra Low Power (ULP)

STORAGE CONDITIONS

- Cells should be stored in a clean & dry (less than 30 % RH) area

For updated information please visit our website www.tadiranbat.com

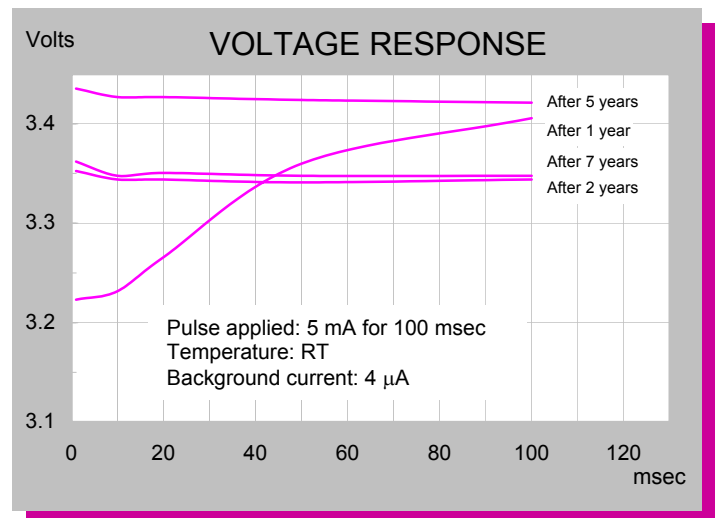
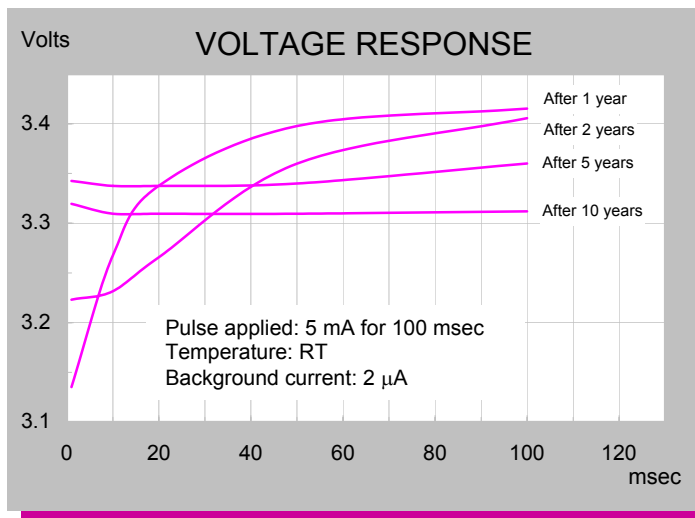

iXtra - Long Term High Performance

X-ON Electronics

Largest Supplier of Electrical and Electronic Components

Click to view similar products for [Electronic Battery](#) category:

Click to view products by [Tadiran](#) manufacturer:

Other Similar products are found below :

[R88A-BAT02W](#) [TL-5104/SBP](#) [E300781900](#) [E300782100](#) [BR-435/BN](#) [B73180A0101M199](#) [13299-0001](#) [R88A-BAT01G](#) [R88A-BAT01W](#)
[M4T32-BR12SH6](#) [LR03AD/4P](#) [13331-0001](#) [3G2A9BAT08](#) [LR03AD/B](#) [LR20AD/B](#)