



TAI-SAW TECHNOLOGY CO., LTD.

No. 3, Industrial 2nd Rd., Ping-Chen Industrial District,
Taoyuan, 324, Taiwan, R.O.C.

TEL: 886-3-4690038 FAX: 886-3-4697532

E-mail: tstsales@mail.taisaw.com Web: www.taisaw.com

Product Specifications Approval Sheet

Product Description: SAW Filter 802MHz SMD 3.8×3.8mm

TST Parts No.:TA0450A

Customer Parts No.:_____

Customer signature required
Company:_____
Division:_____
Approved by :_____
Date:_____

Checked by:_____ Anne Chen 

Approval by:_____ Andy Yu 

Date:_____ 2019/07/22

1. Customer signed back is required before TST can proceed with sample build and receive orders.
2. Orders received without customer signed back will be regarded as agreement on the specifications.
3. Any specifications changes must be approved upon by both parties and a new revision of specifications shall be released to reflect the changes.

SAW Filter 802 MHz

MODEL NO.: TA0450A

REV. NO.:2.0

A. MAXIMUM RATING:

1. Input Power Level: 15 dB_m
2. DC voltage: 5 V
3. Operating Temperature: -10°C to 60°C
4. Storage Temperature: -40°C to +85°C
5. Moisture Sensitivity Level: Level 1(MSL1)

RoHS Compliant
Lead free
Lead-free soldering

Electrostatic Sensitive Device

B. CHARACTERISTICS:

Item				Min.	Typ.	Max.
Center frequency	Fc	MHz		-	802	-
Insertion loss	798 ~ 806 MHz	IL	dB	-	2.5	4.2
Amplitude ripple	798 ~ 806 MHz		dB	-	0.3	2.0
VSWR	798 ~ 806 MHz			-	1.4	2.2
Attenuation						
10.0 ~ 730.0		MHz	dB	40	59	-
730.0 ~ 765.0		MHz	dB	36	57	-
840.0 ~ 860.0		MHz	dB	35	55	-
860.0 ~ 880.0		MHz	dB	36	55	-
880.0 ~ 1000.0		MHz	dB	40	55	-
Source impedance		Zs	Ω	-	50	-
Load impedance		ZL	Ω	-	50	-

Note1. No matching network required for operation at 50Ω

C. Transfer Function:

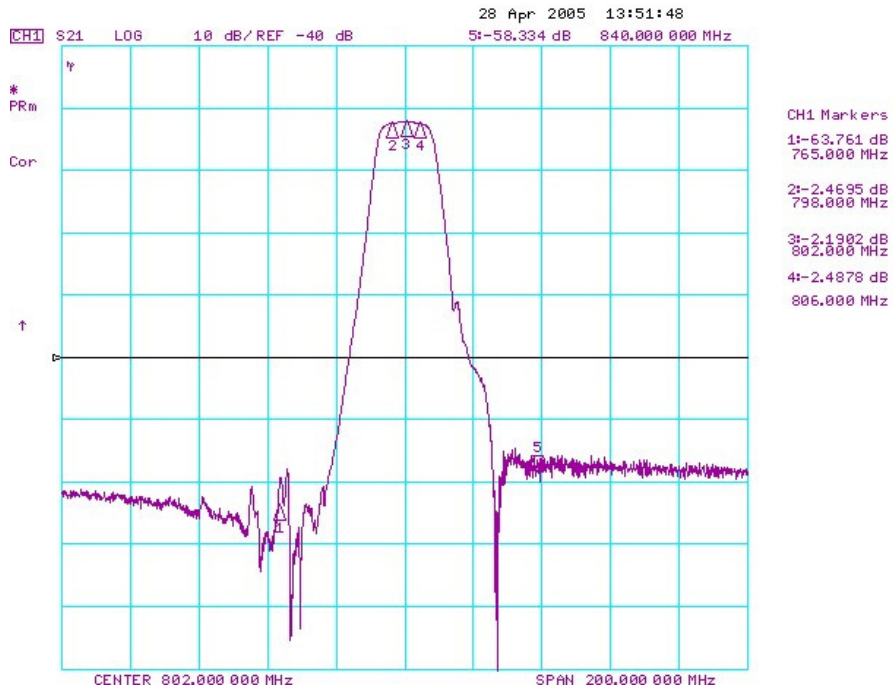

Wideband

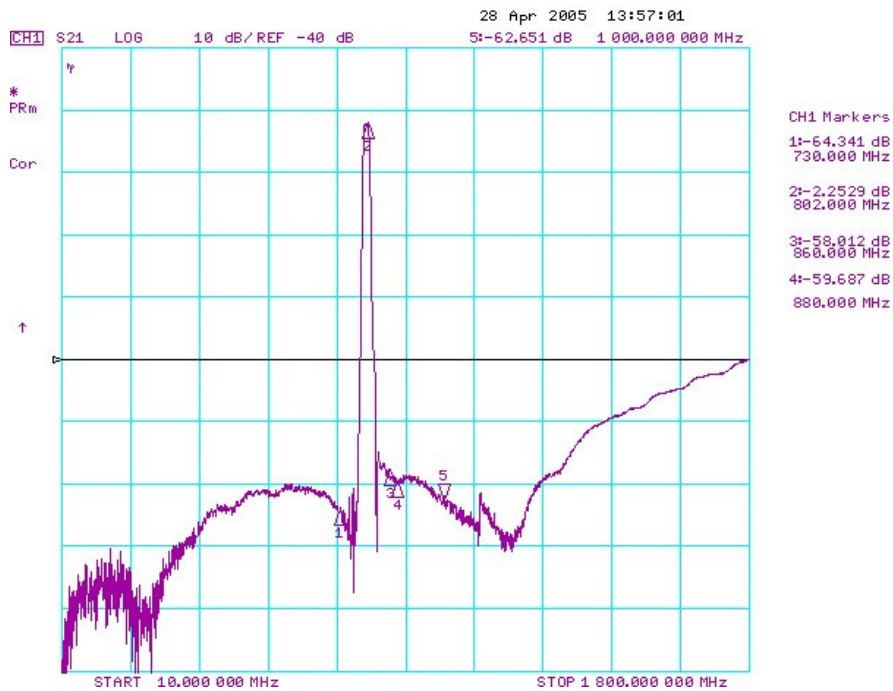

D. Reflection Functions:

S11

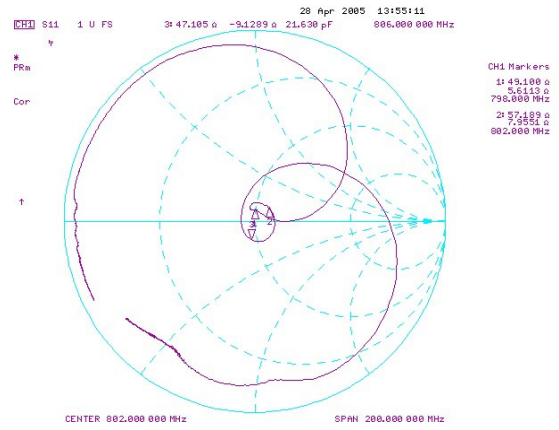
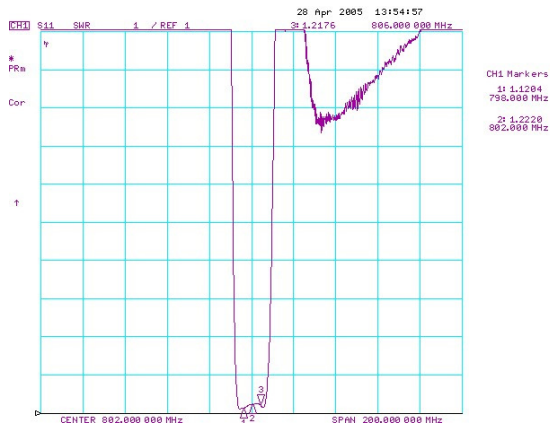

S22

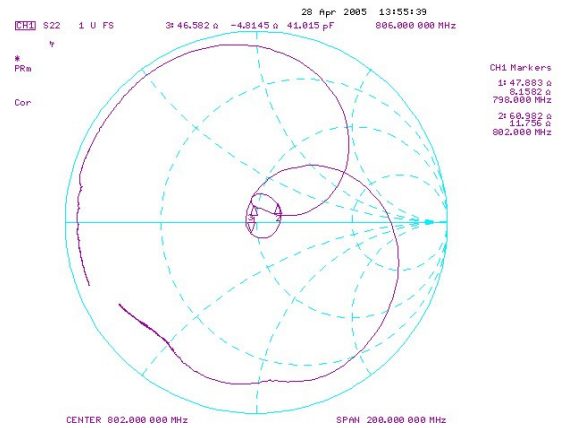
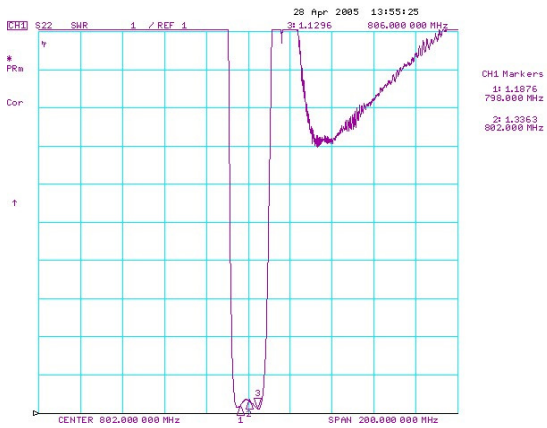

E.OUTLINE DRAWING:

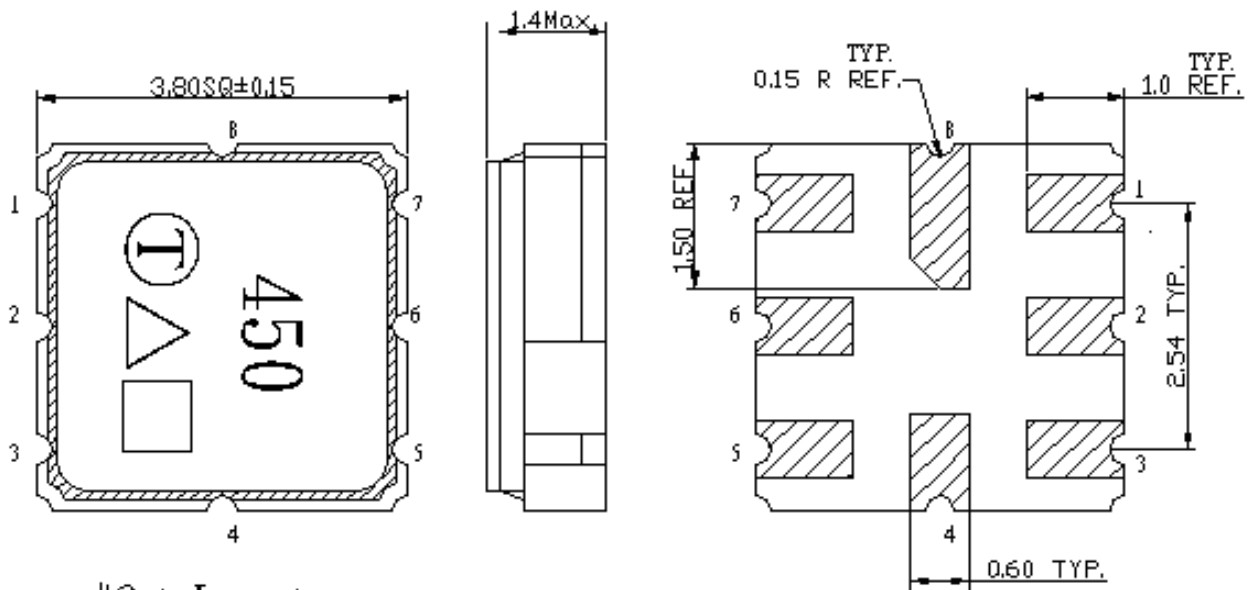

- #2 : Input
- #6 : Output
- #1, 3, 4, 5, 7, 8 : Ground
- △ : Year code
- : Date code
- Unit : mm

Product / Year Code

Year	2019 2021	2020 2022
Product Code	A	a

Week Code Table

WK01	WK02	WK03	WK04	WK05	WK06	WK07	WK08	WK09	WK10	WK11	WK12	WK13
A	B	C	D	E	F	G	H	I	J	K	L	M
WK14	WK15	WK16	WK17	WK18	WK19	WK20	WK21	WK22	WK23	WK24	WK25	WK26
N	O	P	Q	R	S	T	U	V	W	X	Y	Z
WK27	WK28	WK29	WK30	WK31	WK32	WK33	WK34	WK35	WK36	WK37	WK38	WK39
a	b	c	d	e	f	g	h	i	j	k	l	m
WK40	WK41	WK42	WK43	WK44	WK45	WK46	WK47	WK48	WK49	WK50	WK51	WK52
n	o	p	q	r	s	t	u	v	w	x	y	z

F. MEASUREMENT CIRCUIT:

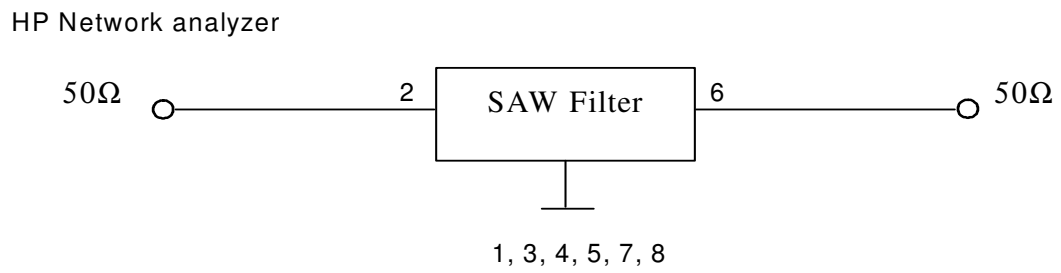

G. PCB FOOTPRINT:

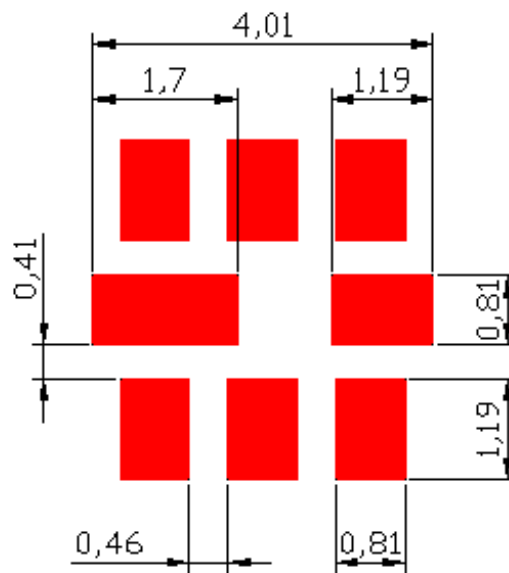

H. PACKING:

1. REEL DIMENSION (Please refer to FR-75D10 for packing quantity)

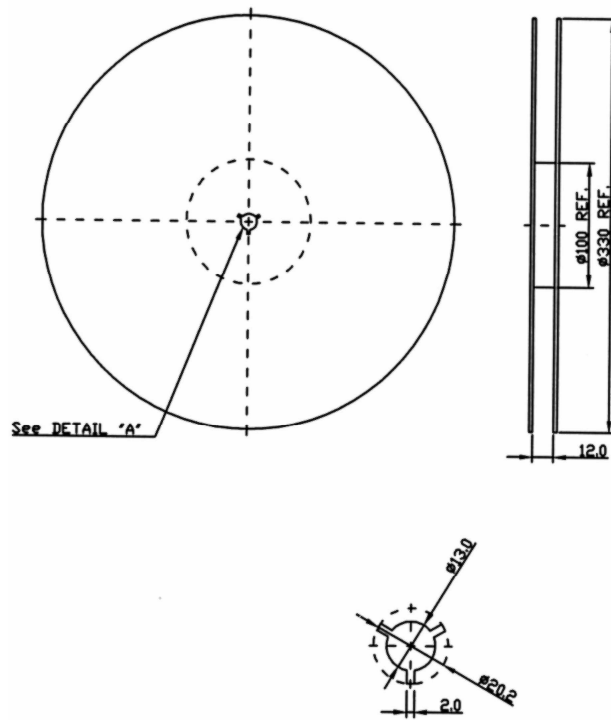

2. TAPE DIMENSION

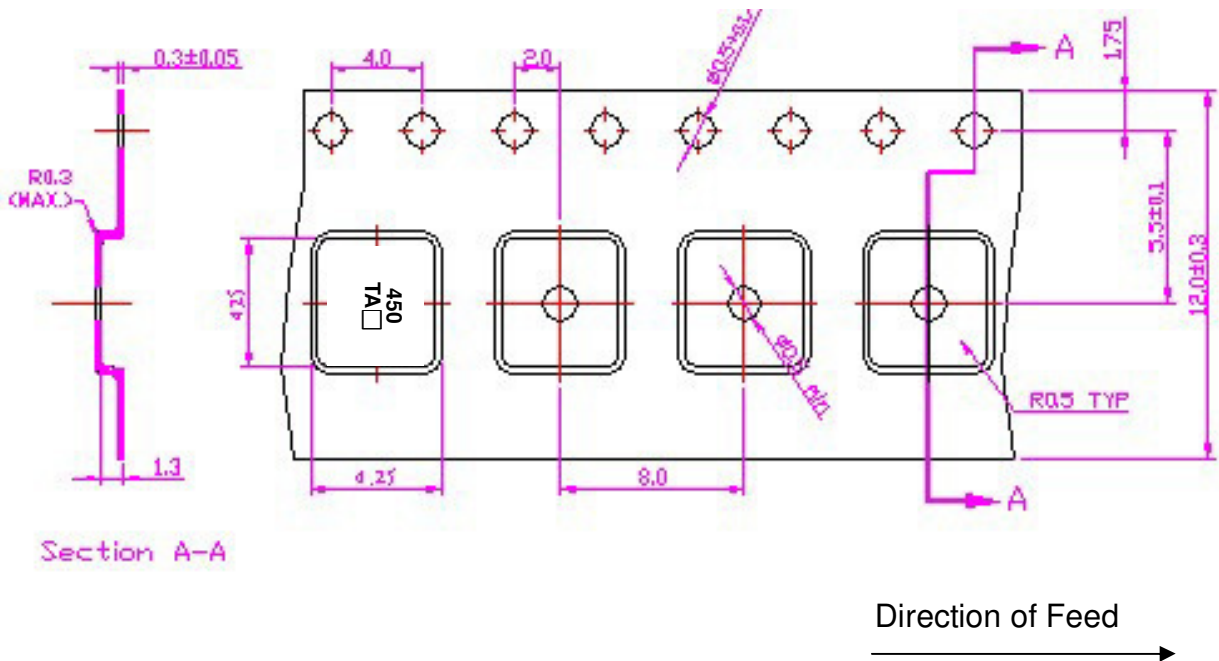

I. RECOMMENDED REFLOW PROFILE:

1. Preheating shall be fixed at 150~180°C for 60~90 seconds.
2. Ascending time to preheating temperature 150°C shall be 30 seconds min.
3. Heating shall be fixed at 220°C for 50~80 seconds and at 260°C +0/-5°C peak (20~40sec).
4. Time: 2 times.

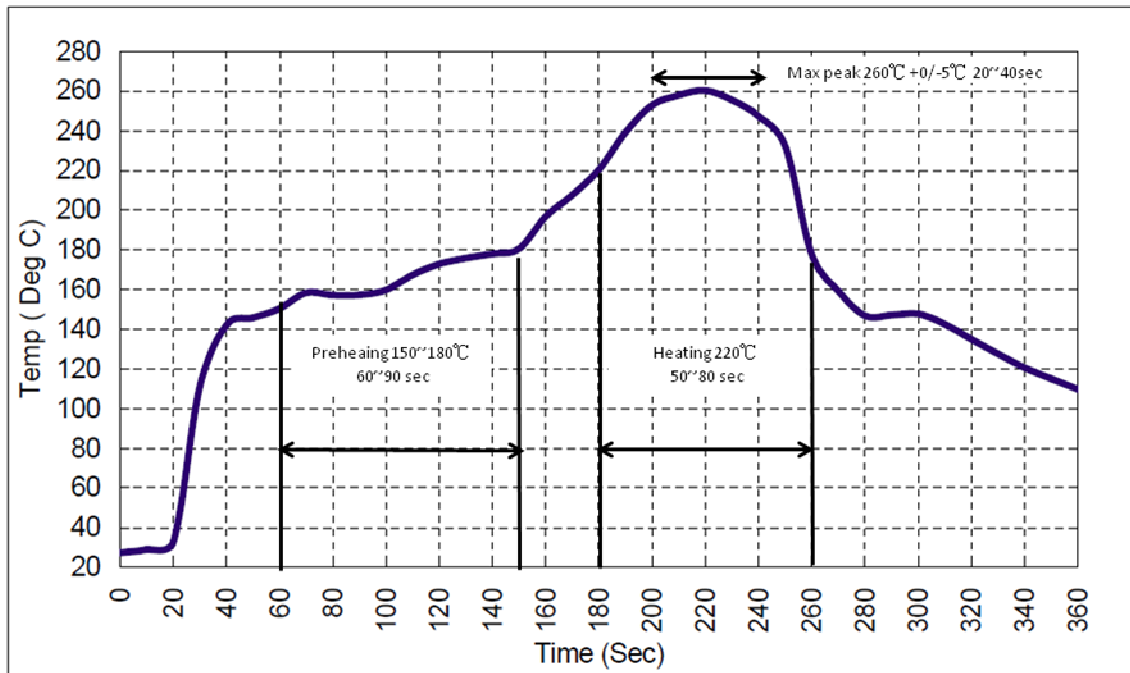

X-ON Electronics

Largest Supplier of Electrical and Electronic Components

Click to view similar products for [Signal Conditioning](#) category:

Click to view products by [Tai-Saw Technology](#) manufacturer:

Other Similar products are found below :

[MAPDCC0001](#) [MAPDCC0004](#) [PD0409J5050S2HF](#) [HHS-109-PIN](#) [AFS14A35-1591.50-T3](#) [DS-323-PIN](#) [DSS-313-PIN](#) [JP510S](#)
[LFB322G45SN1A504](#) [SF2159E](#) [FM-104-PIN](#) [CER0813B](#) [MAPDCC0005](#) [3A325](#) [BD0810N50100AHF](#) [JHS-115-PIN](#) [DC0710J5005AHF](#)
[DC2327J5005AHF](#) [LFB2H2G60BB1C106](#) [LFL15869MTC1B787](#) [X3C19F1-20S](#) [XC3500P-20S](#) [CDBLB455KCAX39-B0](#) [RF1353C](#) [051157-](#)
[0000](#) [PD0922J5050D2HF](#) [600S150FTRB](#) [1E1305-3](#) [1F1304-3S](#) [1G1304-30](#) [TP-103-PIN](#) [BD1222J50200AHF](#) [BD1722J50100AHF](#)
[2450DP39K5400E](#) [BD0810J50150AHF](#) [BD1722J50200AHF](#) [DSS-113-PIN](#) [DS-327-PIN](#) [MACP-008125-CK07F0](#) [DS-329-PIN](#) [DS-313-PIN](#)
[M38510/10304BCA](#) [TP-104-PIN](#) [HH-128-PIN](#) [JP506S](#) [XC0900P-10S](#) [XC0900B-30S](#) [CHE1260-QAG](#) [11305-10](#) [5962-9091202MXA](#)