



TAI-SAW TECHNOLOGY CO., LTD.

No. 3, Industrial 2nd Rd., Ping-Chen Industrial District,
Taoyuan, 324, Taiwan, R.O.C.

TEL: 886-3-4690038 FAX: 886-3-4697532

E-mail: tstsales@mail.taisaw.com Web: www.taisaw.com

Product Specifications Approval Sheet

Product Description: Tuning Fork Crystal Unit 3.2x1.5 32.768KHz

TST Part No.: TZ1510A

Customer Part No.: _____

Customer signature required
Company: _____
Division: _____
Approved by : _____
Date: _____

Checked by: _____ Yifan Chen *Yifan*

Approved by: _____ Kelly Huang *Kelly Huang*

Date: _____ 01/09/2019

1. Customer signed back is required before TST can proceed with sample build and receive orders.
2. Orders received without customer signed back will be regarded as agreement on the specifications.
3. Any specifications changes must be approved upon by both parties and a new revision of specifications shall be released to reflect the changes.



TAI-SAW TECHNOLOGY CO., LTD.

Tuning Fork 3.2x1.5 32.768KHz Crystal Unit

MODEL NO.: TZ1510A

REV. NO.: 4.0

Revise:

Rev.	Rev. Page	Rev. Account	Date	Ref. No.	Reviser
1	N/A	Initial release	06/08/10'	N/A	Ginger Huang
2	P4	Update Marking	08/23/16'	ECN-201600314	Yifan Chen
3	P3	Modify ESR spec	03/06/18'	ECN-201800098	Yifan Chen
4	P3,4	Update spec	01/09/19'	ECN-201900012	Yifan Chen



TAI-SAW TECHNOLOGY CO., LTD.

No. 3, Industrial 2nd Rd., Ping-Chen Industrial District,
Taoyuan, 324, Taiwan, R.O.C.

TEL: 886-3-4690038 FAX: 886-3-4697532

E-mail: tstsales@mail.taisaw.com Web: www.taisaw.com

Tuning Fork 3.2x1.5 32.768KHz Crystal Unit

MODEL NO.: TZ1510A

REV. NO.: 4.0

Features:

- Ceramic Seam Weld Package
- Excellent Reliability Performance
- Ultra Miniature Package
- Available to Surface Mount Technology and IR Reflow Process
- Moisture Sensitivity Level (MSL) : Level-1

RoHS Compliant
Lead free
Lead-free soldering

Description and Applications:

Surface mount 3.2mmx1.5mm crystal unit for use in communications devices,.

Electrical Specifications:

TZ1510A	Specification
Nominal Frequency	32.768 KHz
Storage Temperature Range	-55°C to +125°C
Operating Temperature Range	-40°C to +85°C
Turnover Temperature	25 +/- 5°C
Parabolic Curvature Constant	-0.034 +/-0.006 ppm /°C
Frequency Make Tolerance (FL)	+/-20 ppm @ 25°C
Equivalent Series Resistor (ESR)	70 kΩ max.
Drive Level	1.0 uW max.
Load Capacitance (CL)	9 pF
Aging	+/-3.0 ppm/year @25°C
Insulation Resistance	500M Ω min at DC 100V +/-15V
Marking	Laser marking

Mechanical Dimensions (mm):

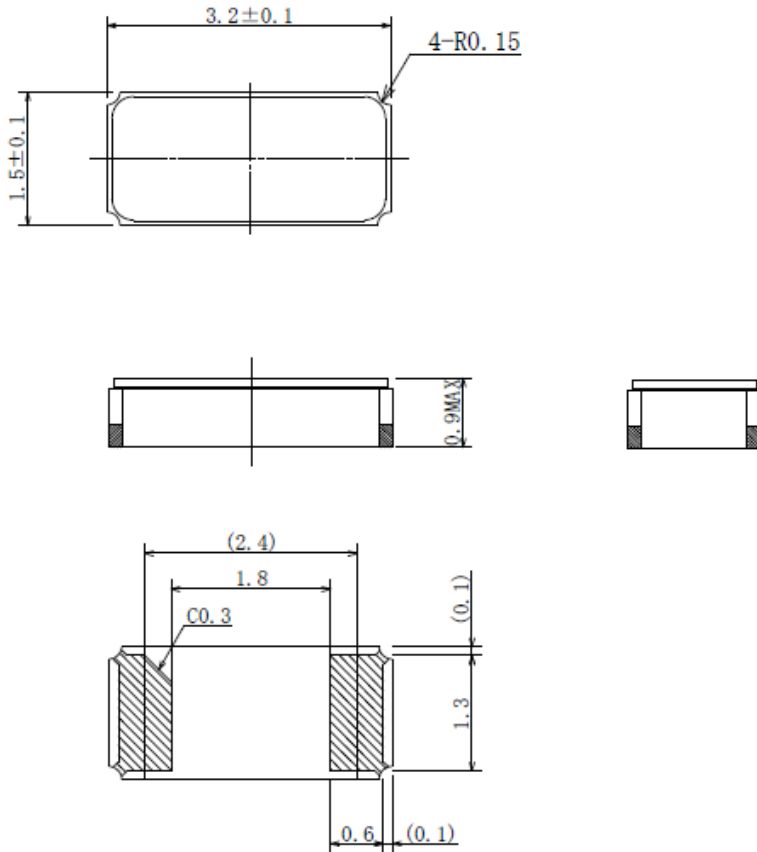

Recommended Land Pattern: (unit: mm)

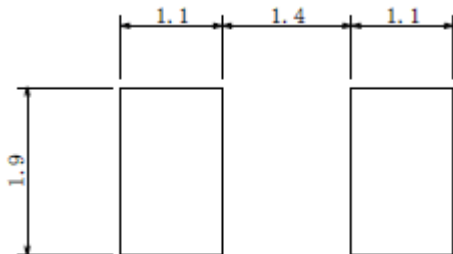

Marking:



y: The last digit of production year.

m: Production month.(See Table 1)

###: Lot.No.

Table 1

Month	1	2	...	9	10	11	12
Code	1	2	...	9	X	Y	Z

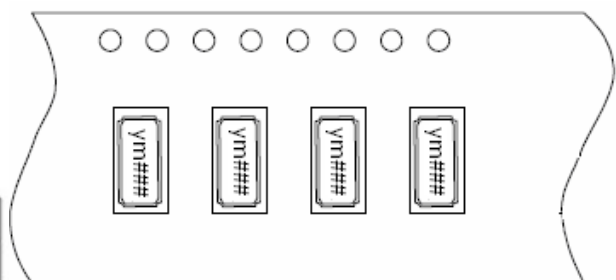

Reel Dimensions (mm):

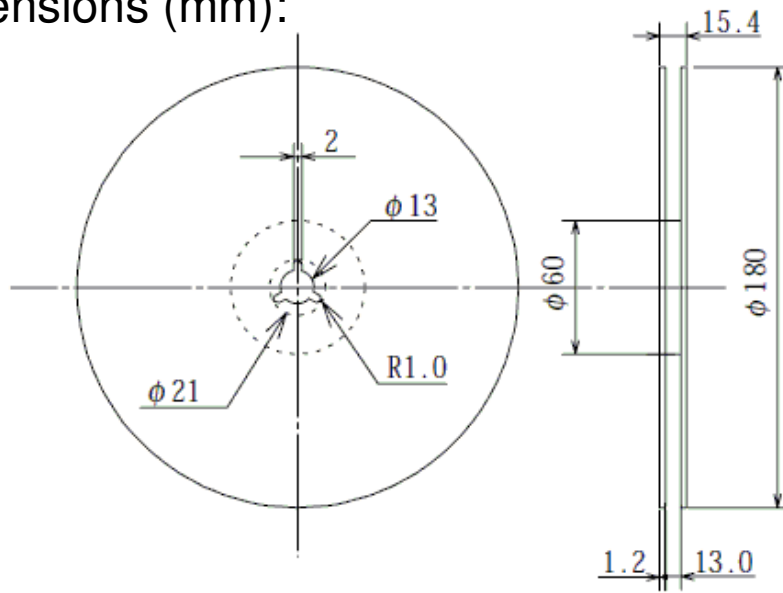

Tape Dimensions (mm):

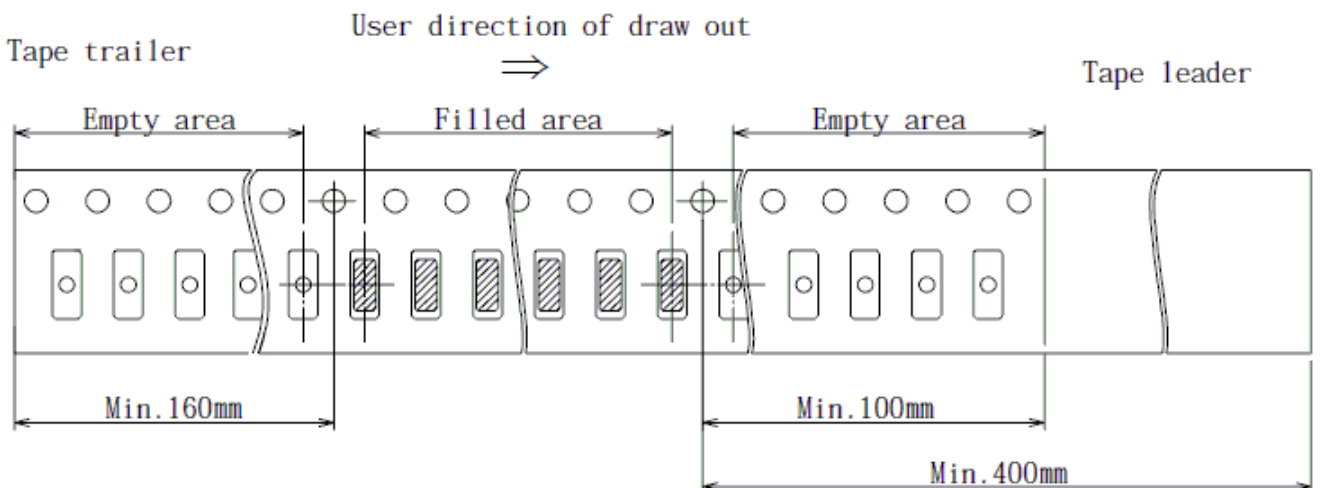
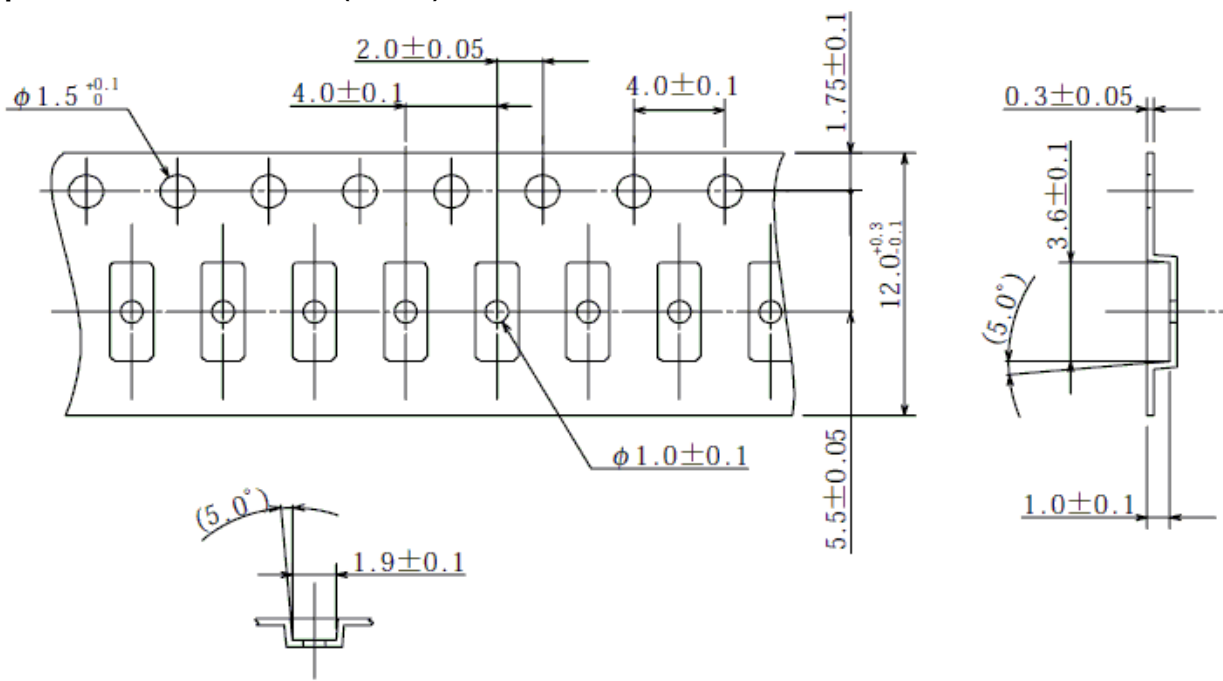

Packing Quantity/Packing:

3K pcs maximum per reel

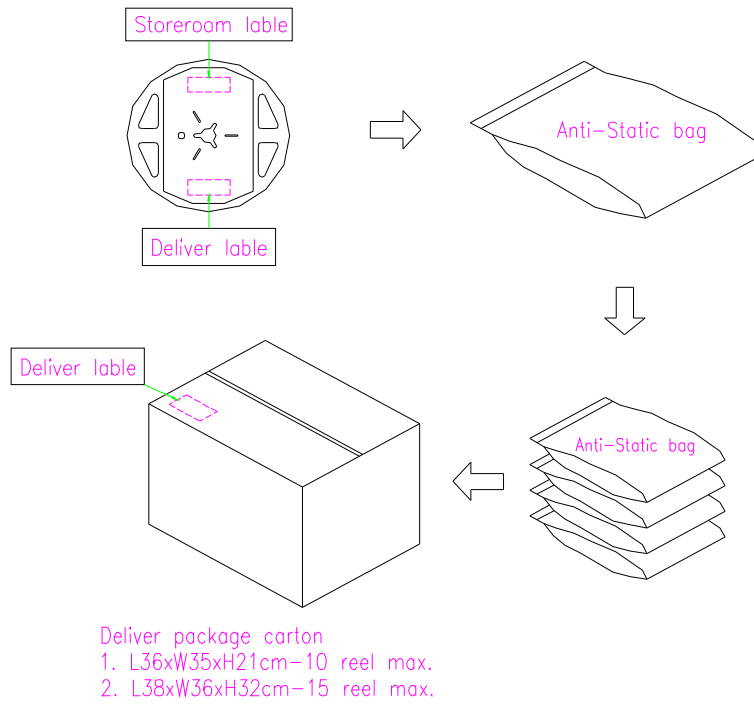

Reflow Profile:

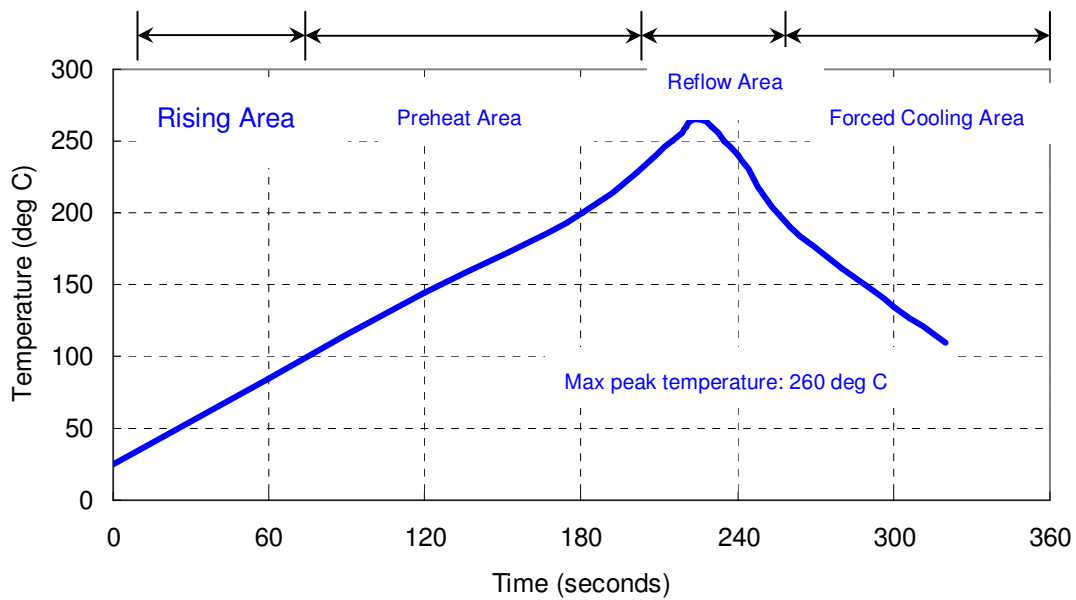

Reliability Specifications

Test name	Test process / method	Reference standard
Mechanical characteristics		
resistance to Soldering heat (IR reflow)	Temp/ Duration : 265°C /10sec ×2 times Total time : 4min.(IR-reflow)	EIAJED-4701 -300(301)M(II)
Vibration	Total peak amplitude : 1.5mm Vibration frequency : 10 to 2000 Hz Sweep period : 20 minute Vibration directions : 3 mutually perpendicular Duration : 2 hr / direc.	MIL-STD 202G method 204
Mechanical Shock	directions : 3 impacts per axis Acceleration : 3000g's, +20/-0 % Duration : 0.3 ms (total 18 shocks) Waveform : Half-sine	MIL-STD 202G method 213
Solderability	Solder Temperature:265±5 °C Duration time: 5±0.5 seconds.	J-STD-002
Environmental characteristics		
Thermal Shock	Heat cycle conditions -40 °C (30min) ↔ 85 °C (30min) * cycle time : 10 times	MIL-STD 883G method 1010.8
Humidity test	Temperature : 85 ± 2 °C Relative humidity : 85% Duration : 96 hours	MIL-STD 202G method 103
Dry heat (Aging test)	Temperature : 125 ± 2 °C Duration : 168 hours	MIL-STD 202G method 108A
Cold resistance (Low Temp Storage)	Temperature : -40 ± 2 °C Duration : 96 hours	IEC 60068-2-1

X-ON Electronics

Largest Supplier of Electrical and Electronic Components

Click to view similar products for [Crystals](#) category:

Click to view products by [Tai-Saw Technology](#) manufacturer:

Other Similar products are found below :

[CX3225GB25000M0PPSZ1](#) [718-13.2-1](#) [7A-40.000MAAE-T](#) [FL2000085](#) [99-BU](#) [9B-15.360MBBK-B](#) [9C-7.680MBBK-T](#) [H10S-12.000-18-EXT-TR](#) [ABC2-6.000MHZ-D4Z-T](#) [ABLS-20.000MHZ-D2-T](#) [ABS071-32.768KHZ-6-T](#) [R38-32.768-12.5-5PPM-NPB](#) [BTD1062E05A-513](#) [21U15A-21.4MHZ](#) [RTX-781DF1-S-20.950](#) [LFXTAL066198Cutt](#) [9C-14.31818MBBK-T](#) [A-11.000MHZ-27](#) [ABL-27.000MHZ-B4Y-T](#) [ABM11-132-24.000MHZ-T3](#) [ABM3B1-25.000MHZ-D2Y-T](#) [SPT2A-.032768B](#) [SPT2A.032768G](#) [SSPT7F-9PF20-R](#) [LFXTAL065253Cutt](#) [LFXTAL066431Cutt](#) [XT9S20ANA14M7456](#) [XT9SNLANA16M](#) [7A-24.576MBBK-T](#) [7B-30.000MBBK-T](#) [MMCC2R32.7680KHZ](#) [7A-14.31818MBBK-T](#) [6504-202-1501](#) [6526-202-1501](#) [ABLS-12.000MHZ-B2Y-T](#) [7A-10.000MBBK-T](#) [SG636PCE-20.000MC](#) [3404](#) [E1SAA18-25.000M TR](#) [CM315D32768EZFT](#) [C1E-24.000-7-2020-R](#) [C1E-19.200-12-1530-X-R](#) [C1E-16.000-12-1530-X-R](#) [ABM11-16.000MHZ-9-B1U-T](#) [FL5000014](#) [EUCA18-3.1872M](#) [FX0800015](#) [425F35E027M0000](#) [FP0800018](#) [MS3V-T1R-32.768kHz-7pF-20PPM-TA-QC-Au](#)