



TAI-SAW TECHNOLOGY CO., LTD.

No. 3, Industrial 2nd Rd., Ping-Chen Industrial District,
Taoyuan, 324, Taiwan, R.O.C.
TEL: 886-3-4690038 FAX: 886-3-4697532
E-mail: tstsales@mail.taisaw.com Web: www.taisaw.com

Product Specifications Approval Sheet

Product Description: Crystal Unit SMD 3.2x2.5 32.00MHz

TST Part No.: TZ1775A

Customer Part No.: _____

Customer signature required
Company: _____
Division: _____
Approved by : _____
Date: _____

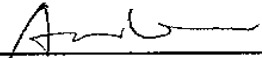
Checked by: Ann Liu 

Approved by: Kelly Huang

Date: 07/09/2010

1. Customer signed back is required before TST can proceed with sample build and receive orders.
2. Orders received without customer signed back will be regarded as agreement on the specifications.
3. Any specifications changes must be approved upon by both parties and a new revision of specifications shall be released to reflect the changes.



TAI-SAW TECHNOLOGY CO., LTD.
Crystal Unit SMD 3.2x2.5 32.00MHz

MODEL NO.: TZ1775A

REV. NO.: 2

Revise:

Rev.	Rev. Page	Rev. Account	Date	Ref. No.	Revised by
1	N/A	Initial release	10/29/09	N/A	Ann Liu
2	3	Adde Base 2	07/09/10	ECN-	Ann Liu



TAI-SAW TECHNOLOGY CO., LTD.

Crystal Unit SMD 3.2x2.5 32.00MHz

MODEL NO.: TZ1775A

REV. NO.: 2

Features:

- Surface Mount Hermetic Package
- Excellent Reliability Performance
- Good Frequency Perturbation and Stability over temperature
- Ultra Miniature Package

RoHS Compliant
Lead free
Lead-free soldering

Description and Applications:

Surface mount 3.2mmx2.5mm crystal unit for customer for use in wireless communications devices, especially for a need of ultra miniature package for mobility.

Electrical Specifications:

TZ1775A	Specification
Nominal Frequency	32.000000 MHz
Mode of Oscillation	Fundamental
Storage Temperature Range	-40°C to +85°C
Operating Temperature Range	-10°C to +60°C
Frequency Stability over Operating Temperature	+/- 10 ppm (referred to the value at 25°C)
Frequency Make Tolerance (FL)	+/- 10 ppm @ 25°C +/- 3°C
Equivalent Series Resistance (ESR)	60 Ω max.
Nominal Drive Level	10 uW
Shunt Capacitance (Co)	3.0 pF max
Load Capacitance (CL)	8 pF
.Insulation Resistance	500 MΩ min./DC 100V
Aging	+/-1ppm/year
Marking	Laser Marking
Unit Weight	0.017+/-0.005 g

Mechanical Dimensions (mm):

Base 1

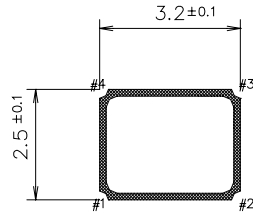

	Pin Connection
#1 pin	IN/OUT
#2 pin	GND
#3 pin	IN/OUT
#4 pin	GND

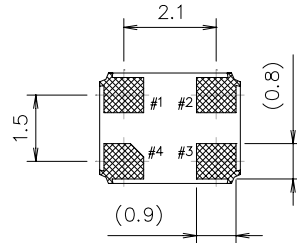
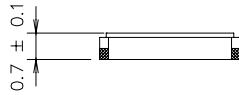

Internal Connections
(Top View)

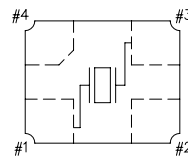

#2, #4 is connected with a cover

Base 2

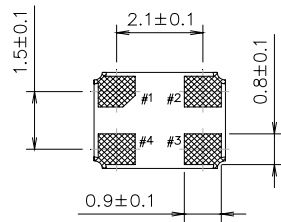

Internal Connections
(Top View)

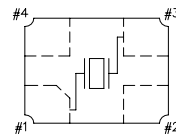

#2, #4 is connected with a cover

Recommended Land Pattern: (unit: mm)

Reference Footpoint

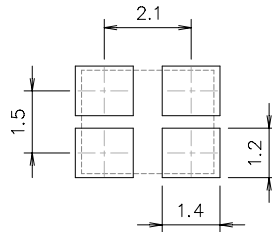

Marking:

Line 1: Frequency (32.00)

Line 2: TST Logo + Crystal Product Code + Date Code + Model Code

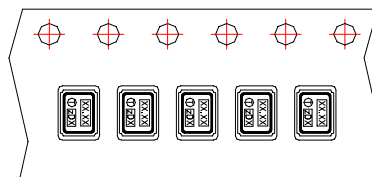
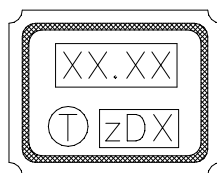

Product Code Table

Year	2009	2010	2011	2012
	2013	2014	2015	2016
	2017	2018	2019	2020
product code	Z	z	Z	z

Date Code Table

WK01	WK02	WK03	WK04	WK05	WK06	WK07	WK08	WK09	WK10	WK11	WK12	WK13
A	B	C	D	E	F	G	H	I	J	K	L	M
WK14	WK15	WK16	WK17	WK18	WK19	WK20	WK21	WK22	WK23	WK24	WK25	WK26
N	O	P	Q	R	S	T	U	V	W	X	Y	Z
WK27	WK28	WK29	WK30	WK31	WK32	WK33	WK34	WK35	WK36	WK37	WK38	WK39
a	b	c	d	e	f	g	h	i	j	k	l	m
WK40	WK41	WK42	WK43	WK44	WK45	WK46	WK47	WK48	WK49	WK50	WK51	WK52
n	o	p	q	r	s	t	u	v	w	x	y	z

Reel Dimensions (mm):

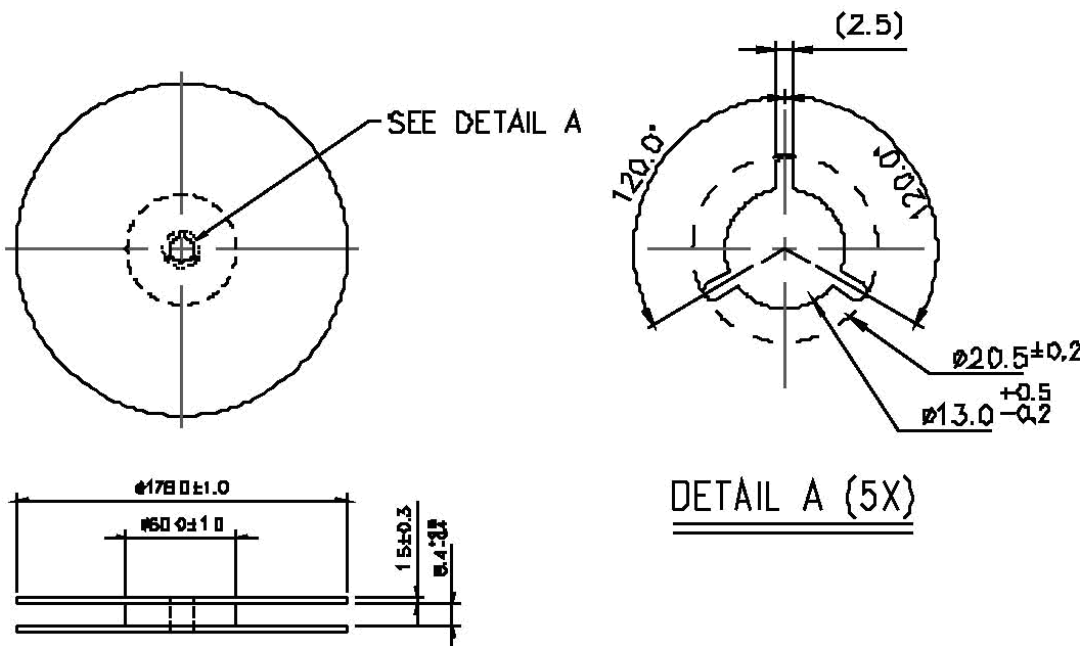

Tape Dimensions (mm):

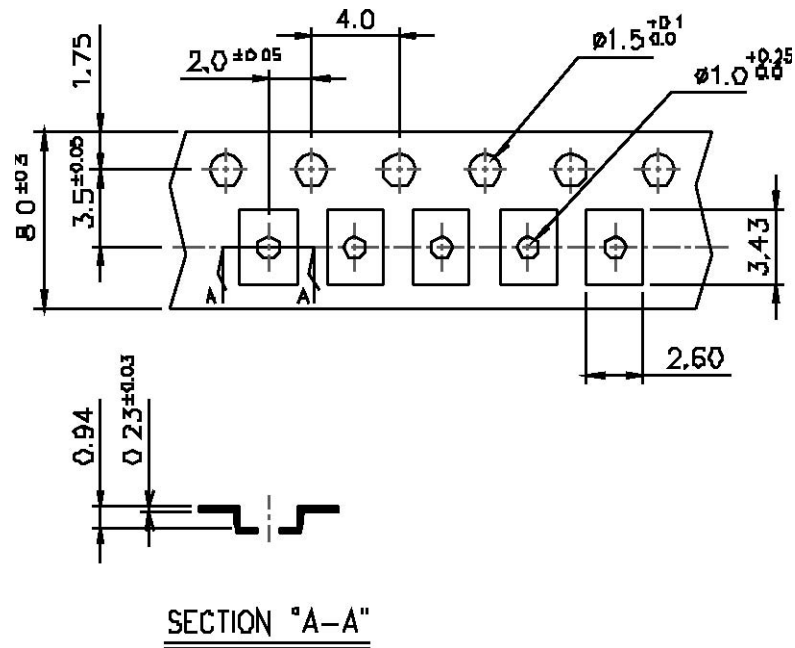

[NOTE]

- 1 UNIT : mm.
- 2 UNLESS OTHERWISE SPECIFIED TOLERANCE ON DIM. +/-0.1mm.
- 3 MATERIAL : CONDUCTIVE POLYSTYRENE.
- 4 COLOR : BLACK.
- 5 10 PITCHES CUMULATIVE TOLERANCE +/-0.2mm.

Packing Quantity/Packing:

3K pcs maximum per reel

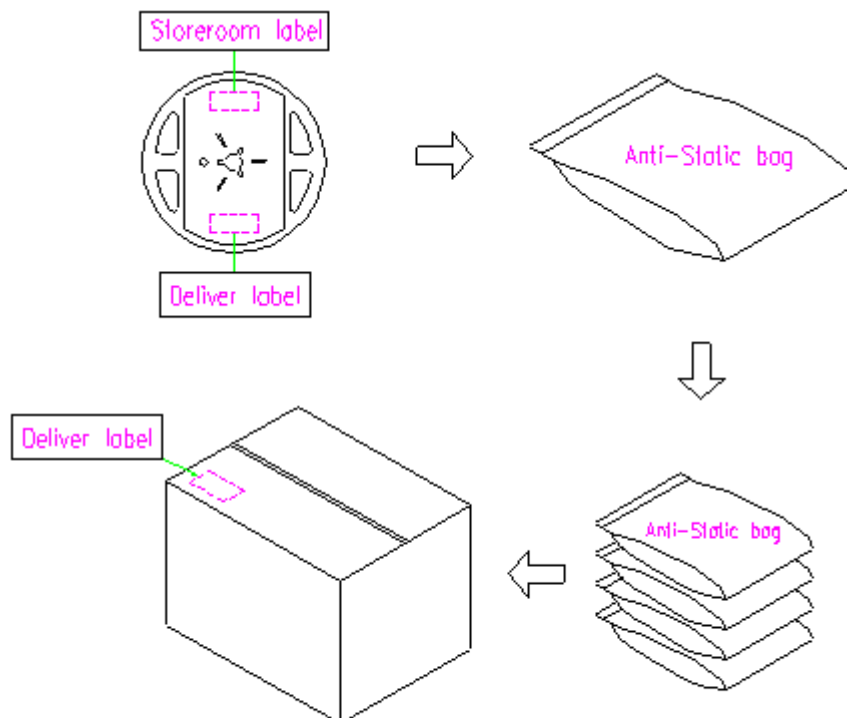

Reflow Profile:

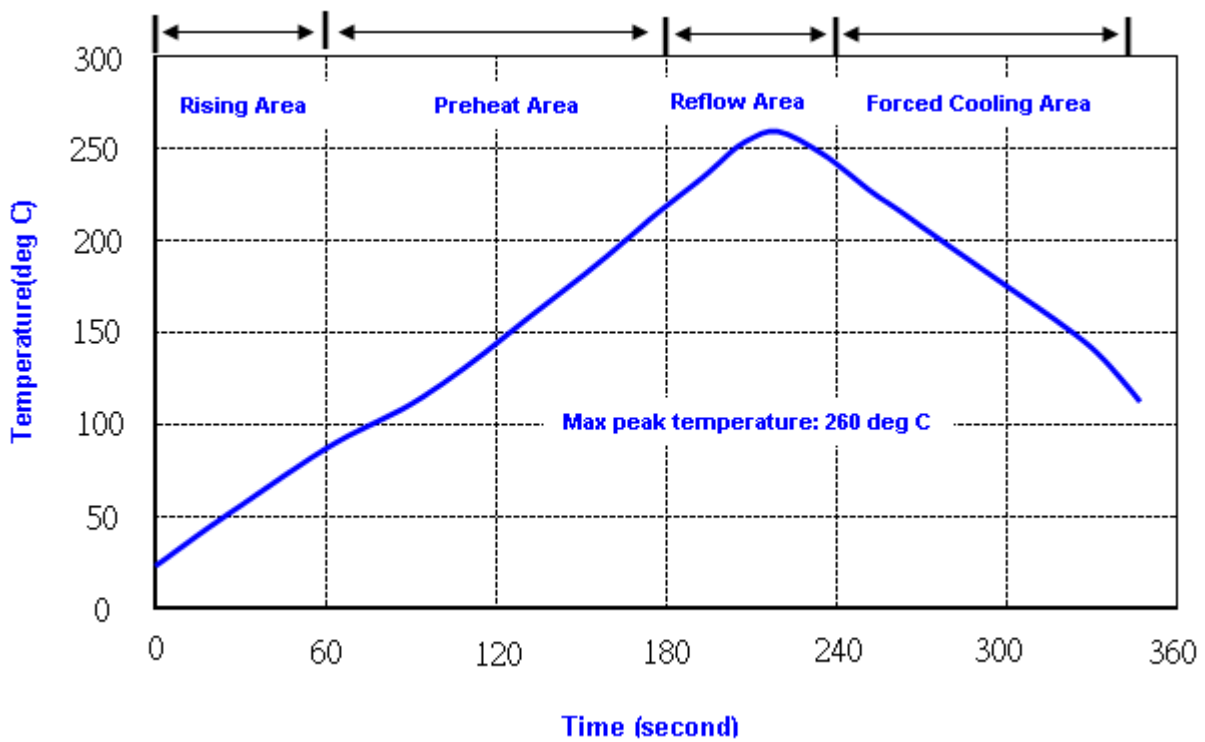

- Note: 1. Max peak temperature: 260 \pm 5 deg C; Time: 10 \pm 2 sec
2. Temperature: 217 \pm 5 deg C; Time: 90~100 sec

Reliability Specifications

Test name	Test process / method	Reference standard
Mechanical characteristics		
resistance to Soldering heat (IR reflow)	Temp./ Duration : 260°C /10sec ×2 times Total time : 4min.(IR-reflow)	EIAJED-4701 -300(301)M(II)
Vibration	Total peak amplitude : 1.5mm Vibration frequency : 10 to 55 Hz Sweep period : 1.0 minute Vibration directions : 3 mutually perpendicular Duration : 2 hr / direc.	MIL-STD 202F method 201A
Mechanical Shock	directions : 3 impacts per axis Acceleration : 3000g's, +20/-0 % Duration : 0.3 ms (total 18 shocks) Waveform : Half-sine	MIL-STD 202F method 213C
Solderability	Solder Temperature:265±5°C Duration time: 5±0.5 seconds.	MIL-STD 883G method 2003
Environmental characteristics		
Thermal Shock	Heat cycle conditions -55 °C (30min) ↔ 125 °C (30min) * cycle time : 10 times	MIL-STD 883G method 1010.7
Humidity test	Temperature : 70 ± 2 °C Relative humidity : 90~95% Duration : 96 hours	MIL-STD 202F method 103B
Dry heat (Aging test)	Temperature : 125 ± 2 °C Duration : 168 hours	MIL-STD 883G method 1008.2 condition C
PCT test	Pressure: 2.06kg/cm ² (2.03*10 ⁵ pa) Temperature : 121 ± 2 °C Relative humidity : 100% Duration : 24 hours	EIAJED-4701-3 B-123A

X-ON Electronics

Largest Supplier of Electrical and Electronic Components

Click to view similar products for [Crystals](#) category:

Click to view products by [Tai-Saw Technology](#) manufacturer:

Other Similar products are found below :

[CX3225GB25000M0PPSZ1](#) [718-13.2-1](#) [7A-40.000MAAE-T](#) [FL2000085](#) [99-BU](#) [9B-15.360MBBK-B](#) [9C-7.680MBBK-T](#) [H10S-12.000-18-EXT-TR](#) [ABC2-6.000MHZ-D4Z-T](#) [ABLS-20.000MHZ-D2-T](#) [ABS071-32.768KHZ-6-T](#) [R38-32.768-12.5-5PPM-NPB](#) [BTD1062E05A-513](#) [21U15A-21.4MHZ](#) [RTX-781DF1-S-20.950](#) [LFXTAL066198Cutt](#) [9C-14.31818MBBK-T](#) [A-11.000MHZ-27](#) [ABL-27.000MHZ-B4Y-T](#) [ABM11-132-24.000MHZ-T3](#) [ABM3B1-25.000MHZ-D2Y-T](#) [SPT2A-.032768B](#) [SPT2A.032768G](#) [LFXTAL065253Cutt](#) [LFXTAL066431Cutt](#) [XT9S20ANA14M7456](#) [XT9SNLANA16M](#) [7A-24.576MBBK-T](#) [7B-30.000MBBK-T](#) [CX2520DB16000H0HPQCC](#) [MMCC2R32.7680KHZ](#) [6504-202-1501](#) [6526-202-1501](#) [ABLS-12.000MHZ-B2Y-T](#) [7A-10.000MBBK-T](#) [SG636PCE-20.000MC](#) [3404](#) [CM315D32768EZFT](#) [C1E-24.000-7-2020-R](#) [C1E-19.200-12-1530-X-R](#) [C1E-16.000-12-1530-X-R](#) [ABM11-16.000MHZ-9-B1U-T](#) [FL5000014](#) [EUCA18-3.1872M](#) [FX0800015](#) [425F35E027M0000](#) [FP0800018](#) [MS3V-T1R-32.768kHz-7pF-20PPM-TA-QC-Au](#) [VXM7-1C1-16M000](#) [MS3V-T1R-32.768kHz-9pF-20PPM-TA-QC-Au](#)