



# TAI-SAW TECHNOLOGY CO., LTD.

No. 3, Industrial 2nd Rd., Ping-Chen Industrial District,  
Taoyuan, 324, Taiwan, R.O.C.

TEL: 886-3-4690038 FAX: 886-3-4697532  
E-mail: [tstsales@mail.taisaw.com](mailto:tstsales@mail.taisaw.com) Web: [www.taisaw.com](http://www.taisaw.com)

## Product Specifications Approval Sheet

Product Description: Crystal Unit SMD 2.0x1.6 32.0MHz

TST Part No.: TZ3375A

Customer Part No.: \_\_\_\_\_

Customer signature required
Company: _____
Division: _____
Approved by : _____
Date: _____

Checked by: \_\_\_\_\_ Chia Haur Rau *CH*

Approved by: \_\_\_\_\_ Kelly Huang *Kelly Huang*

Date: \_\_\_\_\_ 11/07/2017

1. Customer signed back is required before TST can proceed with sample build and receive orders.
2. Orders received without customer signed back will be regarded as agreement on the specifications.
3. Any specifications changes must be approved upon by both parties and a new revision of specifications shall be released to reflect the changes.



**TAI-SAW TECHNOLOGY CO., LTD.**  
Crystal Unit SMD 2.0x1.6 32.0MHz

MODEL NO.: TZ3375A

REV. NO.: 1

**Revise:**

Rev.	Rev. Page	Rev. Account	Date	Ref. No.	Revised by
1	N/A	Initial release	11/07/17'	N/A	Chia Haur Rau



# TAI-SAW TECHNOLOGY CO., LTD.

## Crystal Unit SMD 2.0x1.6 32.0MHz

MODEL NO.: TZ3375A

REV. NO.: 1

### Features:

- Surface Mount Hermetic Package
- Excellent Reliability Performance
- Good Frequency Perturbation and Stability over temperature
- Ultra Miniature Package
- Moisture Sensitivity Level (MSL) : Level-1

RoHS Compliant  
Lead free  
Lead-free soldering

### Description and Applications:

Surface mount 2.0mmx1.6mm crystal unit for use in wireless communications devices, especially for a need of ultra miniature package for mobility.

### Electrical Specifications:

TZ3375A	Specification
Nominal Frequency	32.000000 MHz
Mode of Oscillation	Fundamental
Storage Temperature Range	-40°C to +105°C
Operating Temperature Range	-30°C to +85°C
Frequency Stability over Operating Temperature Range	+/-20 ppm (referred to the value at 25°C)
Frequency Make Tolerance (FL)	+/-20 ppm @ 25°C +/- 3°C
Equivalent Series Resistance (ESR)	70 Ω max
Nominal Drive Level	50uW typical and 100uW max
Shunt Capacitance (Co)	3.0 pF max
Load Capacitance (CL)	6 pF
Aging	+/-5 ppm/year
Insulation Resistance	500 MΩ min./DC 100V
Marking	Laser Marking
Unit Weight	5.7mg+/-0.5mg

# Mechanical Dimensions (mm): Base1

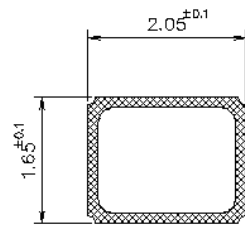

Internal Connections  
(Top View)

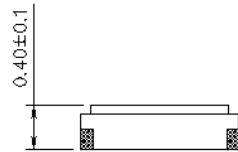
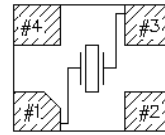

[NOTE] #2, #4 is connected with a metal cover

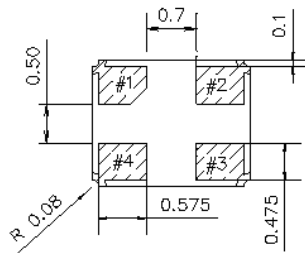

	Pin Connection
#1 pin	IN/OUT
#2 pin	GND
#3 pin	IN/OUT
#4 pin	GND

# Base2

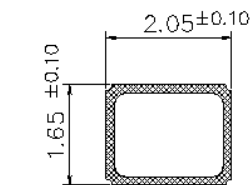

Internal Connections  
(Top View)

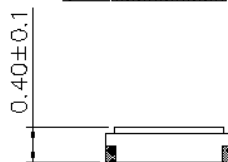
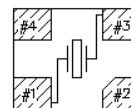

[NOTE] #2, #4 is connected with a metal cover

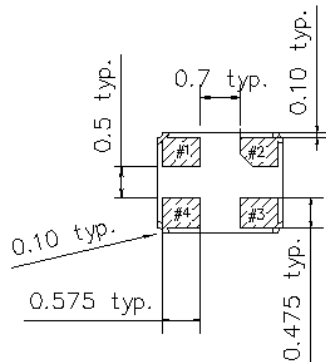

	Pin connection
#1 Pin	IN/OUT
#2 Pin	GND
#3 Pin	IN/OUT
#4 Pin	GND

# Recommended Land Pattern: (unit: mm)

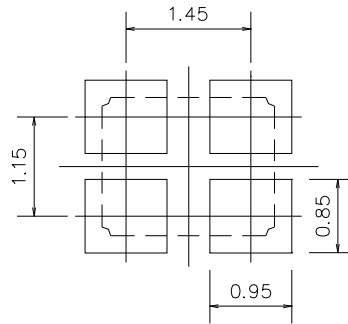

Recommended Land Pattern

## Marking:

Line 1: XX; Frequency (32)

Line 2: T; Traceable Code + D; date Code of Year/Month

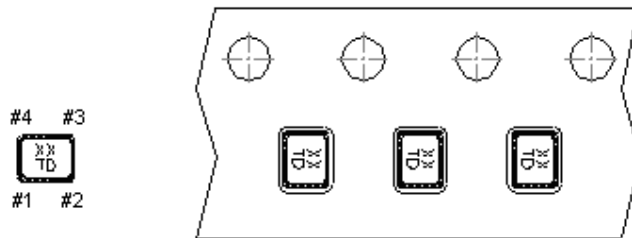

## Date Code Table: Year/Month

Year/Month	1	2	3	4	5	6	7	8	9	10	11	12
2009	n	p	q	r	s	t	u	v	w	x	y	z
2010	A	B	C	D	E	F	G	H	J	K	L	M
2011	N	P	Q	R	S	T	U	V	W	X	Y	Z
2012	a	b	c	d	e	f	g	h	i	j	k	m
2013	n	p	q	r	s	t	u	v	w	x	y	z
2014	A	B	C	D	E	F	G	H	J	K	L	M
2015	N	P	Q	R	S	T	U	V	W	X	Y	Z
2016	a	b	c	d	e	f	g	h	i	j	k	m
2017	n	p	q	r	s	t	u	v	w	x	y	z
2018	A	B	C	D	E	F	G	H	J	K	L	M
2019	N	P	Q	R	S	T	U	V	W	X	Y	Z
2020	a	b	c	d	e	f	g	h	i	j	k	m
2021	n	p	q	r	s	t	u	v	w	x	y	z

## Reel Dimensions (mm):

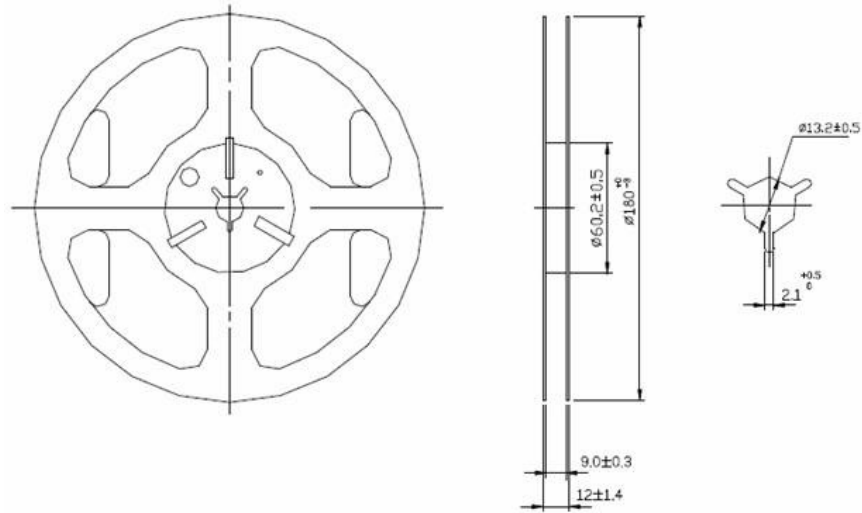

## Tape Dimensions (mm):

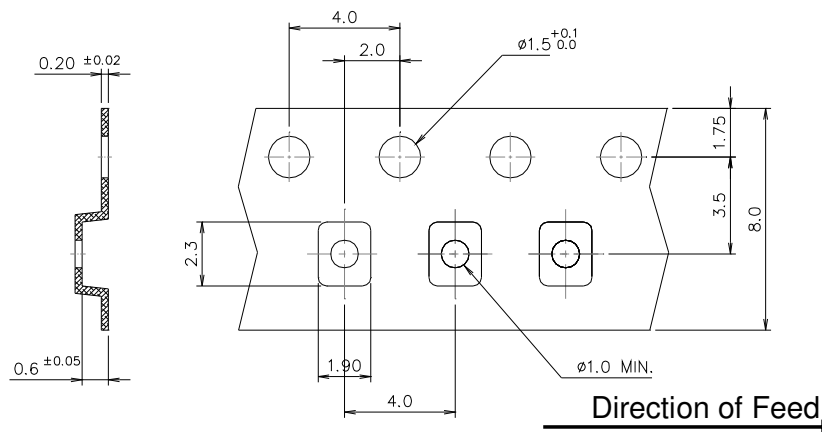

### [NOTE]:

1. Unless otherwise specified tolerance on dimension  $\pm 0.1$  mm.
2. Material: conductive polystyrene with color black.
3. 10 pitch cumulative tolerance  $\pm 0.2$  mm.

## Packing Quantity/Packing:

3K pcs maximum per reel

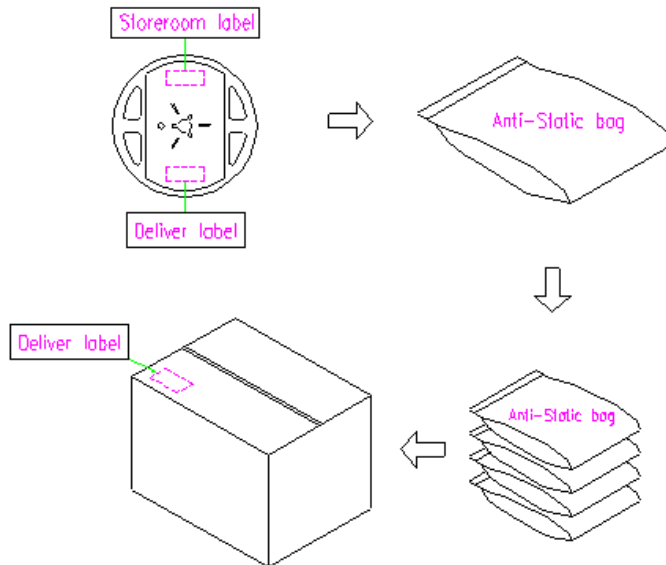

## Reflow Profile:

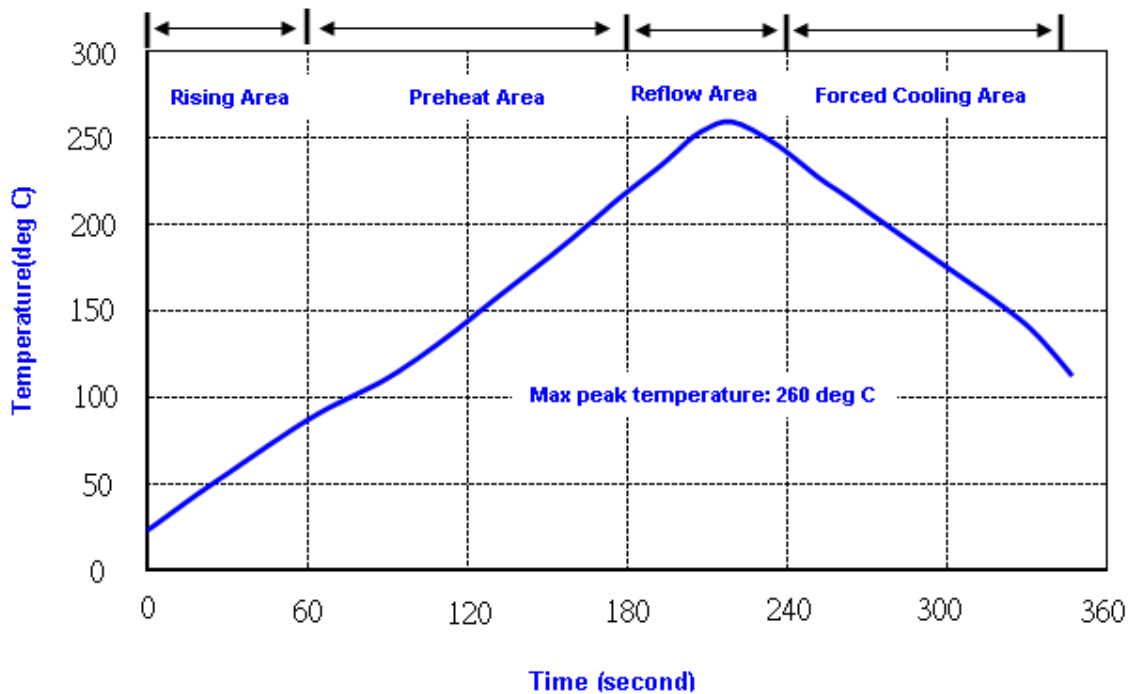

- Note: 1. Max peak temperature: 260 $\pm$ 5 deg C; Time: 10 $\pm$ 2 sec  
 2. Temperature: 217 $\pm$ 5 deg C; Time: 90~100 sec

## Reliability Specifications

Test name	Test process / method	Reference standard
<b>Mechanical characteristics</b>		
resistance to Soldering heat (IR reflow)	Temp/ Duration : 265°C / 10sec × 2 times Total time : 4min. (IR-reflow)	EIAJED-4701  -300(301)M(II)
Vibration	Total peak amplitude : 1.5mm Vibration frequency : 10 to 2000 Hz Sweep period : 20 minute Vibration directions : 3 mutually perpendicular Duration : 2 hr / direc.	MIL-STD 202G method 204
Mechanical Shock	directions : 3 impacts per axis Acceleration : 3000g's, +20/-0 % Duration : 0.3 ms (total 18 shocks) Waveform : Half-sine	MIL-STD 202G method 213
Solderability	Solder Temperature: 265±5°C Duration time: 5±0.5 seconds.	J-STD-002
<b>Environmental characteristics</b>		
Thermal Shock	Heat cycle conditions -40 °C (30min) ↔ 85 °C (30min) * cycle time : 10 times	MIL-STD 883G method 1010.8
Humidity test	Temperature : 85 ± 2 °C Relative humidity : 85% Duration : 96 hours	MIL-STD 202G method 103
Dry heat ( Aging test )	Temperature : 125 ± 2 °C Duration : 168 hours	MIL-STD 202G method 108A
Cold resistance (Low Temp Storage)	Temperature : -40 ± 2 °C Duration : 96 hours	IEC 60068-2-1



## X-ON Electronics

Largest Supplier of Electrical and Electronic Components

*Click to view similar products for [Crystals](#) category:*

*Click to view products by [Tai-Saw Technology](#) manufacturer:*

Other Similar products are found below :

[CX3225GB25000M0PPSZ1](#) [718-13.2-1](#) [7A-40.000MAAE-T](#) [FL2000085](#) [99-BU](#) [9B-15.360MBBK-B](#) [9C-7.680MBBK-T](#) [H10S-12.000-18-EXT-TR](#) [ABC2-6.000MHZ-D4Z-T](#) [ABLS-20.000MHZ-D2-T](#) [ABS071-32.768KHZ-6-T](#) [R38-32.768-12.5-5PPM-NPB](#) [BTD1062E05A-513](#) [21U15A-21.4MHZ](#) [RTX-781DF1-S-20.950](#) [LFXTAL066198Cutt](#) [9C-14.31818MBBK-T](#) [A-11.000MHZ-27](#) [ABL-27.000MHZ-B4Y-T](#) [ABM11-132-24.000MHZ-T3](#) [ABM3B1-25.000MHZ-D2Y-T](#) [SPT2A-.032768B](#) [SPT2A.032768G](#) [SSPT7F-9PF20-R](#) [LFXTAL065253Cutt](#) [LFXTAL066431Cutt](#) [XT9S20ANA14M7456](#) [XT9SNLANA16M](#) [7A-24.576MBBK-T](#) [7B-30.000MBBK-T](#) [MMCC2R32.7680KHZ](#) [7A-14.31818MBBK-T](#) [6504-202-1501](#) [6526-202-1501](#) [ABLS-12.000MHZ-B2Y-T](#) [7A-10.000MBBK-T](#) [SG636PCE-20.000MC](#) [3404](#) [E1SAA18-25.000M TR](#) [CM315D32768EZFT](#) [C1E-24.000-7-2020-R](#) [C1E-19.200-12-1530-X-R](#) [C1E-16.000-12-1530-X-R](#) [ABM11-16.000MHZ-9-B1U-T](#) [FL5000014](#) [EUCA18-3.1872M](#) [FX0800015](#) [425F35E027M0000](#) [FP0800018](#) [MS3V-T1R-32.768kHz-7pF-20PPM-TA-QC-Au](#)