

Power Inductor

1. Features

1. This specification applies Low Profile Power Inductors.
2. 100% Lead(Pb) & Halogen-Free and RoHS compliant.



2. Dimension

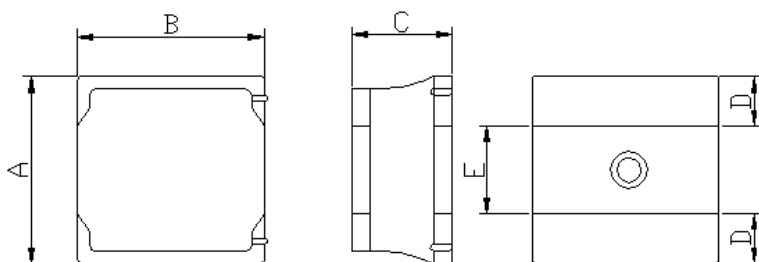

| Series | A(mm) | B(mm) | C(mm) | D(mm) | E(mm) |
|-----------|---------|---------|---------|----------|----------|
| HPC3010TF | 3.0±0.2 | 3.0±0.2 | 1.0max. | 1.0 ref. | 1.0 ref. |

Units: mm

3. Part Numbering

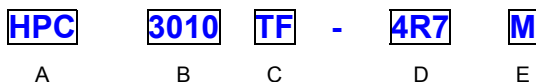

A: Series

B: Dimension

C: Lead Free

D: Inductance 4R7=4.7uH

| TAI-TECH Part Number | Inductance (uH) | Tolerance (%) | Test Frequency (Hz) | DCR (Ω) ±20% | I sat (A) typ. | I rms (A) typ. |
|----------------------|-----------------|---------------|---------------------|--------------|----------------|----------------|
| HPC3010TF-1R0Y | 1.0 | ±30% | 0.1V/1M | 0.055 | 1.80 | 2.10 |
| HPC3010 TF -1R5Y | 1.5 | ±30% | 0.1V/1M | 0.070 | 1.50 | 1.90 |
| HPC3010 TF -2R2M | 2.2 | ±20% | 0.1V/1M | 0.090 | 1.30 | 1.70 |
| HPC3010 TF -3R3M | 3.3 | ±20% | 0.1V/1M | 0.130 | 1.10 | 1.50 |
| HPC3010 TF -4R7M | 4.7 | ±20% | 0.1V/1M | 0.170 | 0.90 | 1.30 |
| HPC3010 TF -6R8M | 6.8 | ±20% | 0.1V/1M | 0.260 | 0.77 | 1.00 |
| HPC3010 TF -100M | 10 | ±20% | 0.1V/1M | 0.350 | 0.63 | 0.80 |
| HPC3010 TF -150M | 15 | ±20% | 0.1V/1M | 0.510 | 0.54 | 0.70 |
| HPC3010 TF -220M | 22 | ±20% | 0.1V/1M | 0.750 | 0.43 | 0.60 |

Note:

Isat : Based on inductance change (ΔL/L0 : ≤-30%) @ ambient temp. 25°C

HPC3010TF-1R0

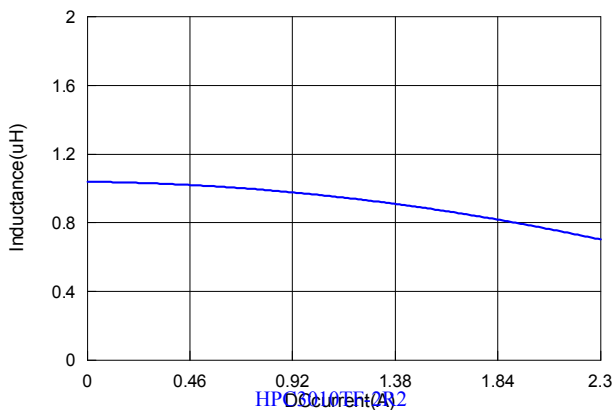

HPC3010TF-1R5

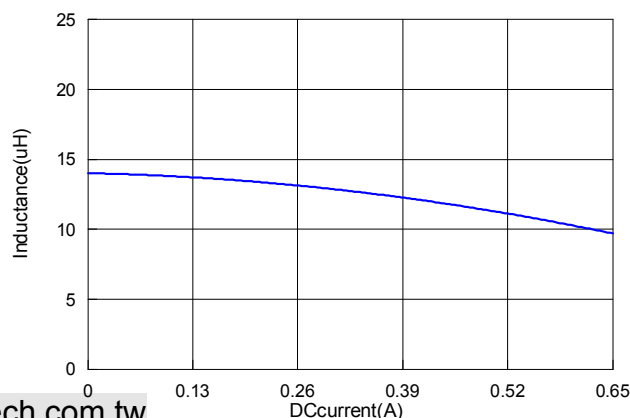
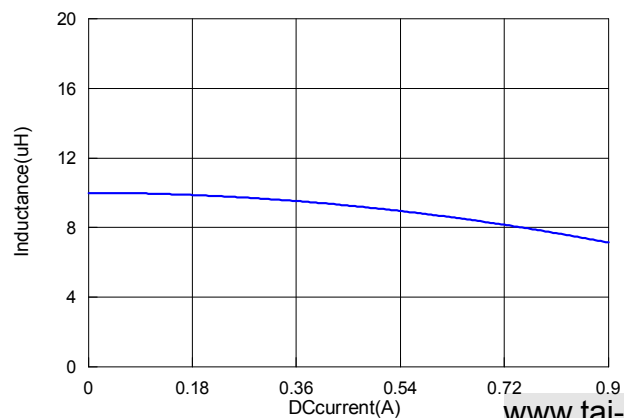
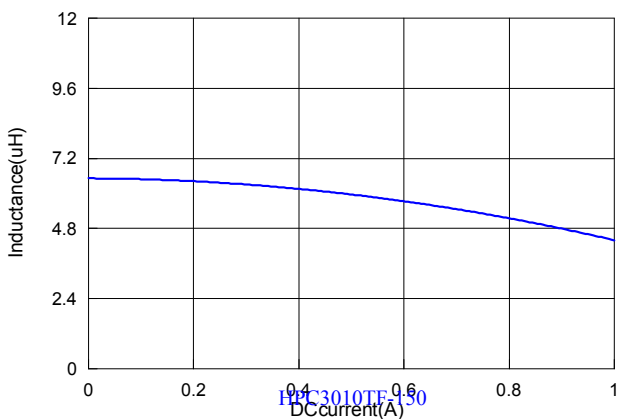
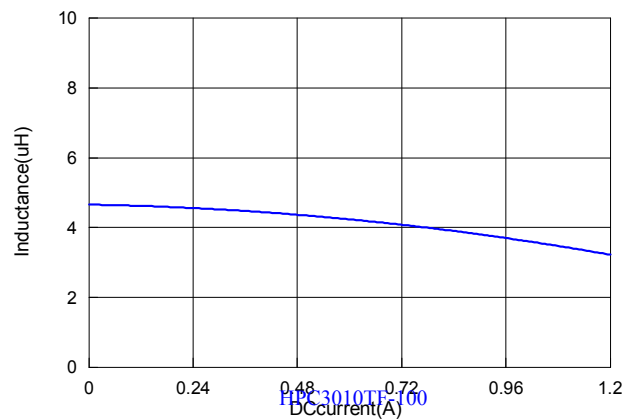
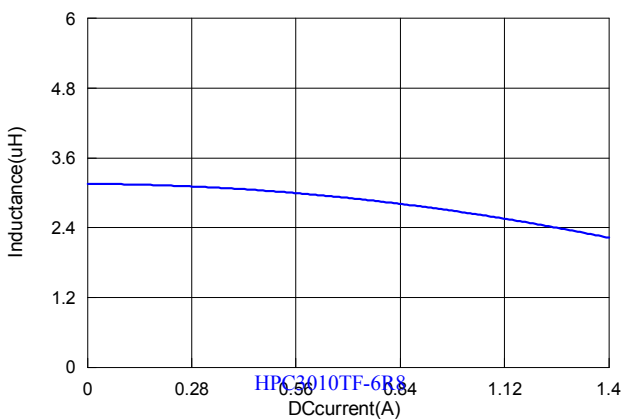
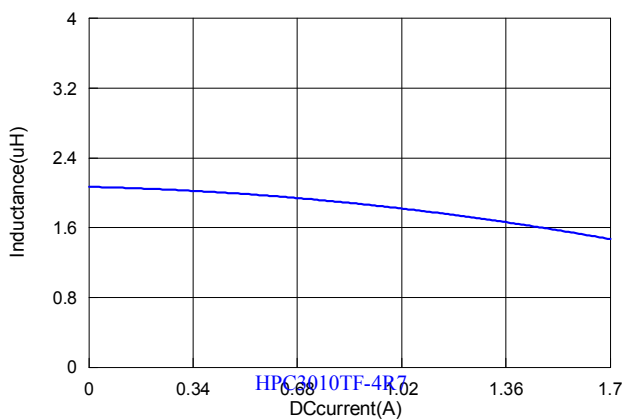
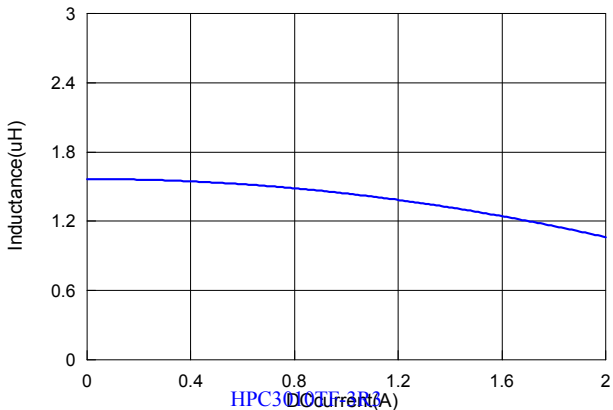

HPC3010TF-220

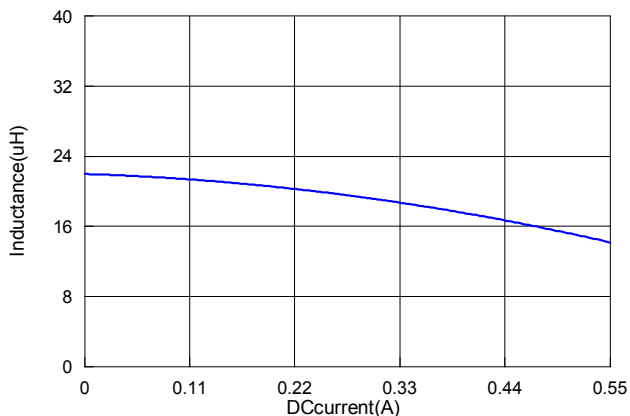

Void appearance tolerance Limit

Size of voids occurring to coating resin is specified below.

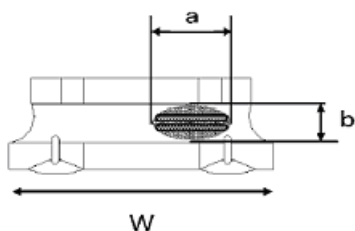

Exposed wire tolerance limit of coating resin on product side.

Size of exposed wire occurring to coating resin is specified below.

1. Width direction (dimension a) : Acceptable when $a \leq w/2$
Nonconforming when $a > w/2$
2. Length direction (dimension b) : Dimension b is not specified.
3. The total area of exposed wire occurring to each sides is not greater than 50% of coating resin area, and is acceptable.

External appearance criterion for exposed wire

Exposed end of the winding wire at the secondary side should be 2mm and below.

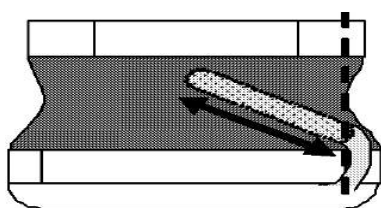

5. Material

| No. | Description | Specification |
|-----|-------------|----------------------------|
| a. | Core | Ferrite Core |
| b. | Coating | Epoxy with magnetic powder |
| c. | Termination | Tin (Pb Free) |
| d. | Wire | Enameled Copper Wire |

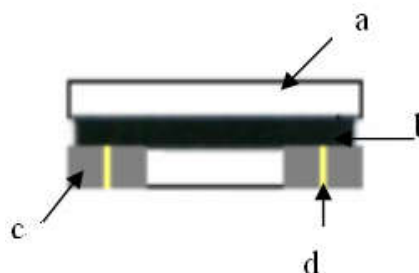

6. Reliability and Test Condition

| Item | Performance | Test Condition | | | | | | | | |
|------------------------------------|---|---|-----------------------|----------|--|-----------------------|---------------------------|------------|---------------------|---|
| Operating Temperature | -55~+125°C (For products in unopened tape package, less than 40°C) | | | | | | | | | |
| Electrical Performance Test | | | | | | | | | | |
| Inductance L | Refer to standard electrical characteristic list | Agilent-4291, Agilent-4287 | | | | | | | | |
| DC Resistance | | Agilent-4338 | | | | | | | | |
| Rated Current | Base on temp. rise & $\Delta L/L0A \leq 30\%$. | Saturation DC Current (Isat) will cause L0 to drop approximately $\Delta L(\%)$. | | | | | | | | |
| Temperature Rise Test | ΔT 40°C Max | Heat Rated Current (Irms) will cause the coil temperature rise approximately $\Delta T(^{\circ}C)$ without core loss. 1. Applied the allowed DC current. 2. Temperature measured by digital surface thermometer | | | | | | | | |
| Mechanical Performance Test | | | | | | | | | | |
| Solder Heat Resistance | Appearance : No damage. Inductance : within $\pm 10\%$ of initial value RDC : within $\pm 15\%$ of initial value and shall not exceed the specification value | <table border="1"> <thead> <tr> <th>Temperature (°C)</th> <th>Time (s)</th> <th>Temperature ramp/immersion and emersion rate</th> <th>Number of heat cycles</th> </tr> </thead> <tbody> <tr> <td>260 \pm 5 (solder temp)</td> <td>10 \pm 1</td> <td>25mm/s \pm 6 mm/s</td> <td>1</td> </tr> </tbody> </table> <p>Depth: completely cover the termination</p> | Temperature (°C) | Time (s) | Temperature ramp/immersion and emersion rate | Number of heat cycles | 260 \pm 5 (solder temp) | 10 \pm 1 | 25mm/s \pm 6 mm/s | 1 |
| Temperature (°C) | Time (s) | Temperature ramp/immersion and emersion rate | Number of heat cycles | | | | | | | |
| 260 \pm 5 (solder temp) | 10 \pm 1 | 25mm/s \pm 6 mm/s | 1 | | | | | | | |
| Solderability Test | More than 95% of terminal electrode should be covered with solder. | Preheat: 150°C, 60sec. ◦ Solder: Sn99.5%-Cu0.5% ◦ Temperature: 245 \pm 5°C ◦ Flux for lead free: Rosin. 9.5% ◦ Dip time: 4 \pm 1sec ◦ Depth: completely cover the termination | | | | | | | | |
| Reliability Test | | | | | | | | | | |
| Life Test | | Preconditioning: Run through IR reflow for 2 times. (IPC/JEDEC J-STD-020D Classification Reflow Profiles) Temperature : 125 \pm 2°C (Bead) Temperature : 85 \pm 2°C (Inductor) Applied current : rated current Duration : 1000 \pm 12hrs Measured at room temperature after placing for 24 \pm 2 hrs | | | | | | | | |
| Thermal shock | Appearance : No damage. Inductance : within $\pm 10\%$ of initial value RDC : within $\pm 15\%$ of initial value and shall not exceed the specification value | Preconditioning: Run through IR reflow for 2 times. (IPC/JEDEC J-STD-020D Classification Reflow Profiles) Step1 : -40 \pm 2°C 30 \pm 5min Step2 : 25 \pm 2°C \leq 0.5min Step3 : 105 \pm 2°C 30 \pm 5min Number of cycles : 500 Measured at room temperature after placing for 24 \pm 2 hrs | | | | | | | | |
| Humidity Resistance Test | | Preconditioning: Run through IR reflow for 2 times. (IPC/JEDEC J-STD-020D Classification Reflow Profiles) Humidity : 85 \pm 2% R.H., Temperature : 85°C \pm 2°C Duration : 1000hrs Min. with 100% rated current Measured at room temperature after placing for 24 \pm 2 hrs | | | | | | | | |

| | |
|-----------------------|---|
| <p>Vibration Test</p> | <p>Preconditioning: Run through IR reflow for 2 times. (IPC/JEDEC J-STD-020D Classification Reflow Profiles) Oscillation Frequency: 10~2K~10Hz for 20 minutes Equipment : Vibration checker Total Amplitude: 1.52mm±10% Testing Time : 12 hours(20 minutes, 12 cycles each of 3 orientations) *</p> |
|-----------------------|---|

7. Soldering and Mounting

7-1. Soldering

PC board should be designed so that products can prevent damage from mechanical stress when warping the board. Products shall be positioned in the sideways direction against the mechanical stress to prevent failure.

7-1.1 Solder re-flow:

Recommended temperature profiles for re-flow soldering in Figure 1.

7-1.2 Soldering Iron(Figure 2):

Products attachment with a soldering iron is discouraged due to the inherent process control limitations. In the event that a soldering iron must be employed the following precautions are recommended.

- Preheat circuit and products to 150°C
- Never contact the ceramic with the iron tip
- Use a 20 watt soldering iron with tip diameter of 1.0mm
- 355°C tip temperature (max)
- 1.0mm tip diameter (max)
- Limit soldering time to 4~5 sec.

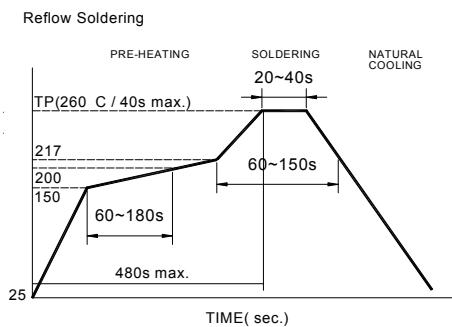

Reflow times: 3 times max.

Fig.1

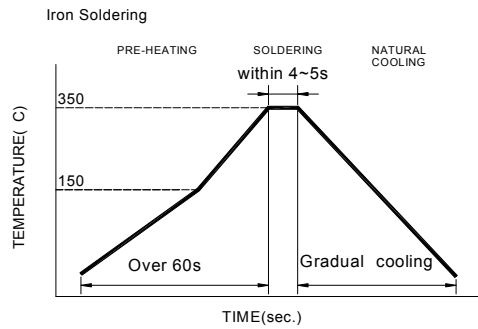

Iron Soldering times: 1 times max.

Fig.2

7-2. Recommended PC Board Pattern

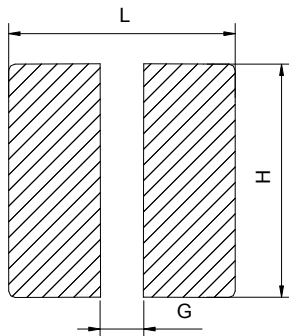

| L(mm) | G(mm) | H(mm) |
|-------|-------|-------|
| 3.2 | 1.0 | 3.2 |

8. Packaging Information

8-1. Reel Dimension

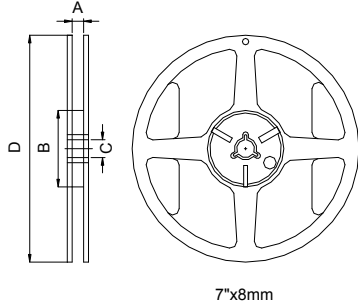

| Type | A(mm) | B(mm) | C(mm) | D(mm) |
|--------|---------|---------|--------|-------|
| 7"x8mm | 8.4±1.0 | 50 min. | 13±0.8 | 178±2 |

8-2. Tape Dimension / 8mm

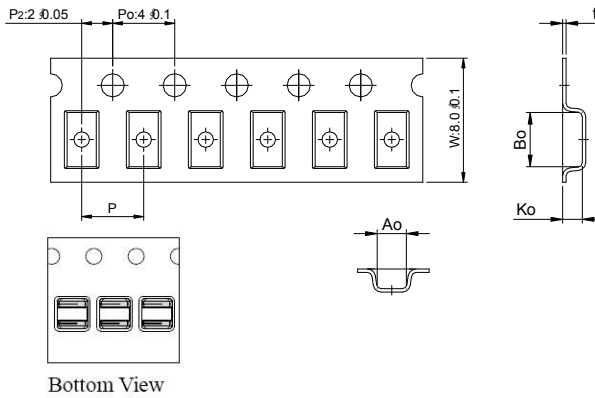

| Series | Size | Bo(mm) | Ao(mm) | Ko(mm) | P(mm) | t(mm) |
|--------|------|----------|----------|----------|----------|-----------|
| HPC | 3010 | 3.2±0.05 | 3.2±0.05 | 1.20±0.2 | 4.0±0.05 | 0.23±0.05 |

8-3. Packaging Quantity

| | |
|-------------|------|
| Chip size | 3010 |
| Chip / Reel | 2000 |

8-4. Tearing Off Force

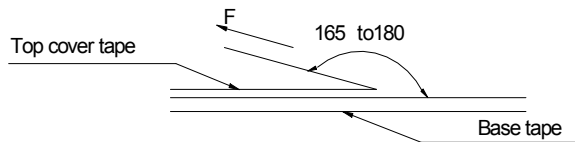

The force for tearing off cover tape is 15 to 80 grams in the arrow direction under the following conditions.

| Room Temp. (°C) | Room Humidity (%) | Room atm (hPa) | Tearing Speed mm/min |
|-----------------|-------------------|----------------|----------------------|
| 5~35 | 45~85 | 860~1060 | 300 |

Application Notice

- Storage Conditions

To maintain the solderability of terminal electrodes:

1. TAI-TECH products meet IPC/JEDEC J-STD-020D standard-MSL, level 1.
2. Temperature and humidity conditions: Less than 40°C and 60% RH.
3. Recommended products should be used within 12 months from the time of delivery.
4. The packaging material should be kept where no chlorine or sulfur exists in the air.

- Transportation

1. Products should be handled with care to avoid damage or contamination from perspiration and skin oils.
2. The use of tweezers or vacuum pick up is strongly recommended for individual components.
3. Bulk handling should ensure that abrasion and mechanical shock are minimized.

X-ON Electronics

Largest Supplier of Electrical and Electronic Components

Click to view similar products for [Fixed Inductors](#) category:

Click to view products by [TAITEC](#) manufacturer:

Other Similar products are found below :

[CR32NP-151KC](#) [CR32NP-180KC](#) [CR32NP-181KC](#) [CR32NP-1R5MC](#) [CR32NP-390KC](#) [CR32NP-3R9MC](#) [CR32NP-680KC](#) [CR32NP-820KC](#) [CR32NP-8R2MC](#) [CR43NP-390KC](#) [CR43NP-560KC](#) [CR43NP-680KC](#) [CR54NP-181KC](#) [CR54NP-470LC](#) [CR54NP-820KC](#) [CR54NP-8R5MC](#) [70F224AI](#) [MGDQ4-00004-P](#) [MHL1ECTTP18NJ](#) [MHQ1005P10NJ](#) [MHQ1005P1N0S](#) [MHQ1005P2N4S](#) [MHQ1005P3N6S](#) [MHQ1005P5N1S](#) [MHQ1005P8N2J](#) [PE-51506NL](#) [PE-53601NL](#) [PE-53602NL](#) [PE-53630NL](#) [PE-53824SNLT](#) [PE-92100NL](#) [PG0434.801NLT](#) [PG0936.113NLT](#) [9220-20](#) [9310-16](#) [PM06-2N7](#) [PM06-39NJ](#) [A01TK](#) [1206CS-471XJ](#) [HC2LP-R47-R](#) [HC2-R47-R](#) [HC3-2R2-R](#) [HCF1305-3R3-R](#) [1206CS-151XG](#) [RCH664NP-140L](#) [RCH664NP-4R7M](#) [RCH8011NP-221L](#) [RCP1317NP-332L](#) [RCP1317NP-391L](#) [RCR1010NP-470M](#)