

Power Inductor

1. Features

1. This specification applies Low Profile Power Inductors.
2. 100% Lead(Pb) & Halogen-Free and RoHS compliant.



2. Dimension

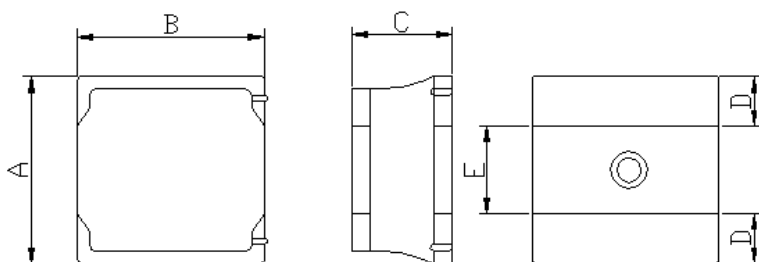

Series	A(mm)	B(mm)	C(mm)	D(mm)	E(mm)
HPC3015TF	3.0±0.2	3.0±0.2	1.5 max.	1.0 ref.	1.0 ref.

Units: mm

3. Part Numbering

HPC
3015
TF
-
2R2
M

- A: Series
 B: Dimension
 C: Lead Free
 D: Inductance

2R2=2.2uH

TAI-TECH Part Number	Inductance (uH)	Tolerance (%)	Test Frequency (Hz)	SRF (MHz) min.	DCR (Ω) ±20%	I sat (A)typ	I rms (A)typ
HPC3015TF-1R0Y	1.0	±30%	1V100K	100	0.030	2.20	2.20
HPC3015 TF -1R5Y	1.5	±30%	1V100K	87	0.040	2.00	2.00
HPC3015 TF -2R2M	2.2	±20%	1V100K	64	0.060	1.70	1.70
HPC3015 TF -3R3M	3.3	±20%	1V100K	49	0.080	1.40	1.40
HPC3015 TF -4R7M	4.7	±20%	1V100K	40	0.120	1.20	1.20
HPC3015 TF -6R8M	6.8	±20%	1V100K	36	0.160	1.00	1.00
HPC3015 TF -100M	10	±20%	1V100K	28	0.220	0.75	0.80
HPC3015 TF -150M	15	±20%	1V100K	23	0.320	0.65	0.70
HPC3015 TF -220M	22	±20%	1V100K	20	0.460	0.55	0.60
HPC3015 TF -330M	33	±20%	1V100K	18	0.800	0.40	0.45
HPC3015 TF -470M	47	±20%	1V100K	17	1.200	0.35	0.40

Note:

I_{sat} : Based on inductance change (ΔL/L0 : ≤-30%) @ ambient temp. 25°C

I_{rms} : Based on temperature rise (ΔT : 40°C)

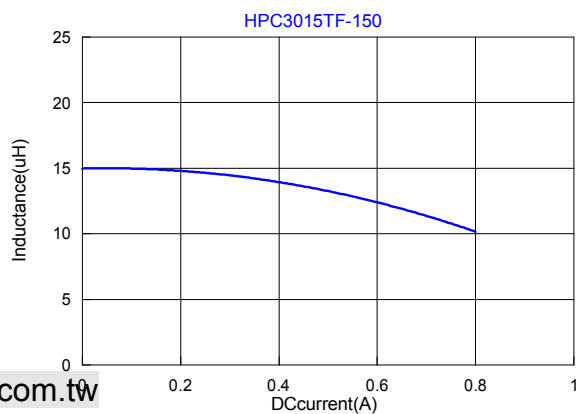
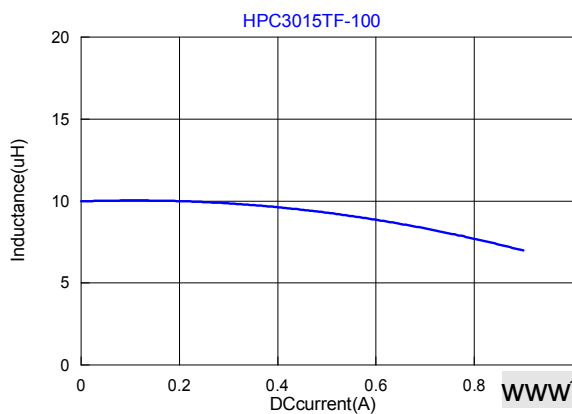
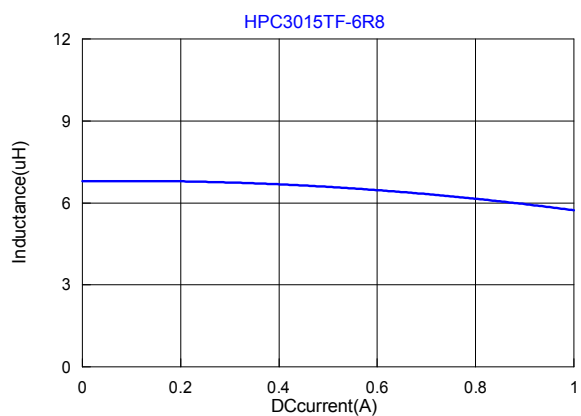
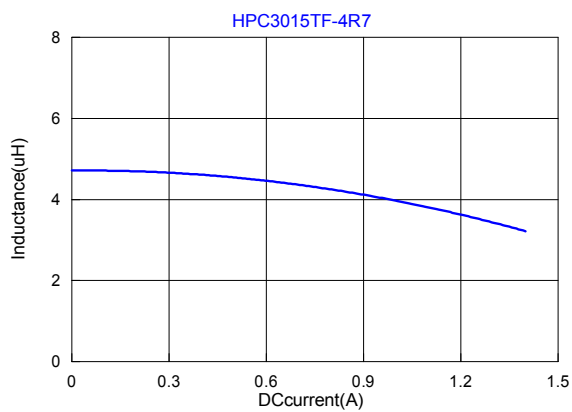
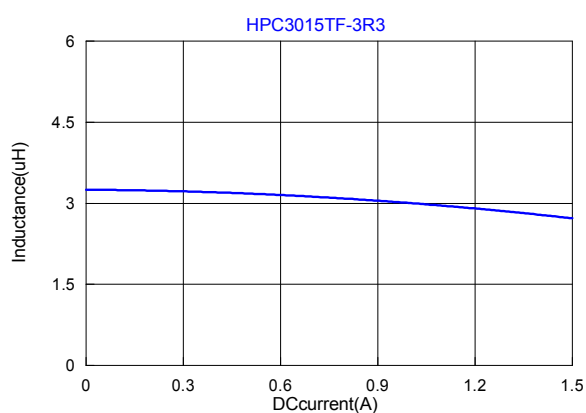
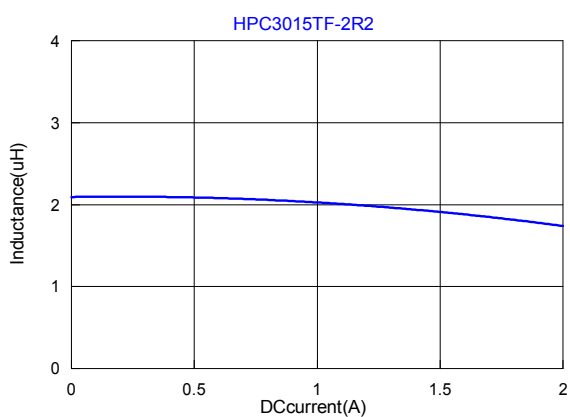
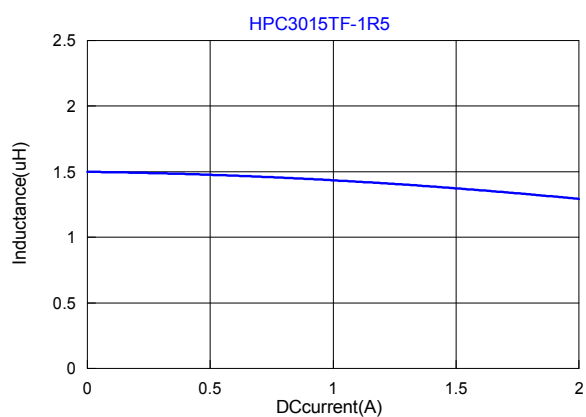
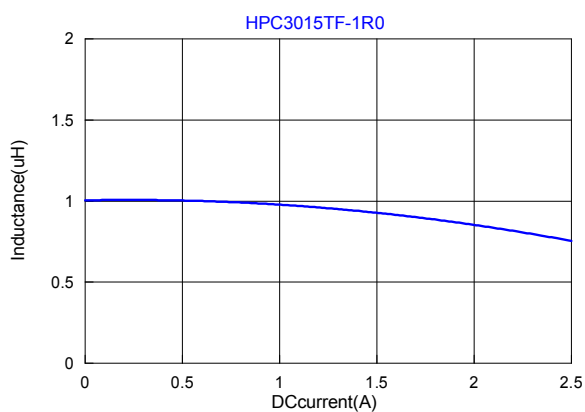

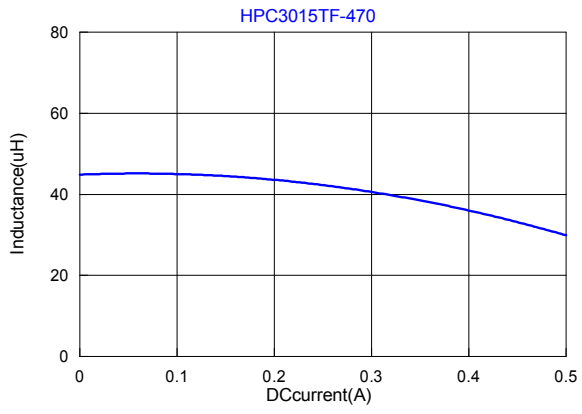
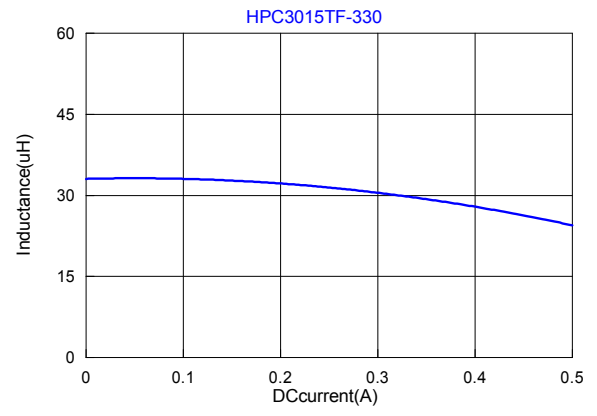
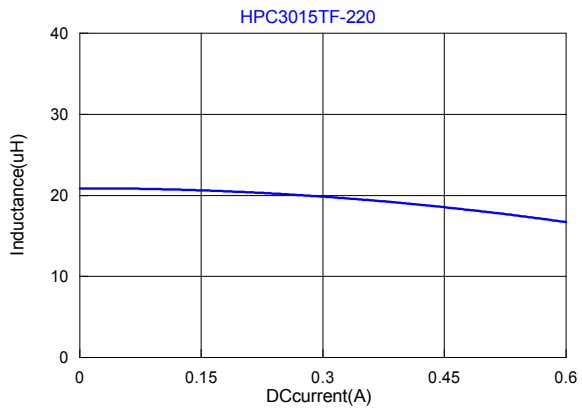

Void appearance tolerance Limit

Size of voids occurring to coating resin is specified below.

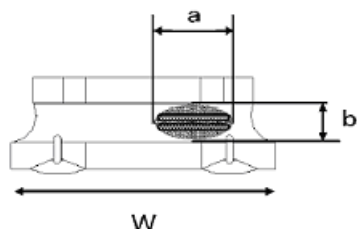

Exposed wire tolerance limit of coating resin part on product side.

Size of exposed wire occurring to coating resin is specified below.

1. Width direction (dimension a) : Acceptable when $a \leq w/2$
Nonconforming when $a > w/2$
2. Length direction (dimension b) : Dimension b is not specified.
3. The total area of exposed wire occurring to each sides is not greater than 50% of coating resin area, and is acceptable.

External appearance criterion for exposed wire

Exposed end of the winding wire at the secondary side should be 2mm and below.

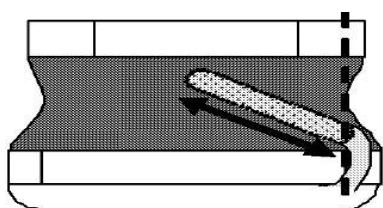

6. Material

No.	Description	Specification
a.	Core	Ferrite Core
b.	Coating	Epoxy
c.	Termination	Tin (Pb Free)
d.	Wire	Enameled Copper Wire

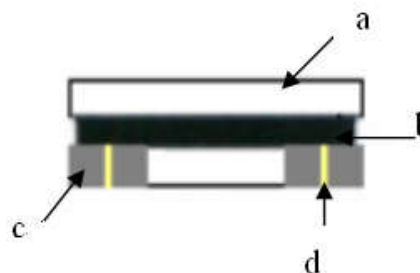

7. Reliability and Test Condition

Item	Performance	Test Condition								
Operating Temperature	-55~+125°C (For products in unopened tape package, less than 40°C)									
Electrical Performance Test										
Inductance L	Refer to standard electrical characteristic list	Agilent-4291, Agilent-4287								
SRF		Agilent-4291 Agilent-E4991								
DC Resistance		Agilent-4291,								
Rated Current	Base on temp. rise & $\Delta L/L0A \leq 30\%$.	Saturation DC Current (Isat) will cause L0 to drop approximately $\Delta L(\%)$.								
Temperature Rise Test	$\Delta T 40^\circ C$ Max	Heat Rated Current (Irms) will cause the coil temperature rise approximately $\Delta T(^\circ C)$ without core loss. 1. Applied the allowed DC current. 2. Temperature measured by digital surface thermometer								
Mechanical Performance Test										
Solder Heat Resistance	Appearance : No damage. Inductance : within±10% of initial value RDC : within ±15% of initial value and shall not exceed the specification value	<table border="1"> <thead> <tr> <th>Temperature (°C)</th> <th>Time (s)</th> <th>Temperature ramp/immersion and emersion rate</th> <th>Number of heat cycles</th> </tr> </thead> <tbody> <tr> <td>260 ±5 (solder temp)</td> <td>10 ±1</td> <td>25mm/s±6 mm/s</td> <td>1</td> </tr> </tbody> </table> <p>Depth: completely cover the termination</p>	Temperature (°C)	Time (s)	Temperature ramp/immersion and emersion rate	Number of heat cycles	260 ±5 (solder temp)	10 ±1	25mm/s±6 mm/s	1
Temperature (°C)	Time (s)	Temperature ramp/immersion and emersion rate	Number of heat cycles							
260 ±5 (solder temp)	10 ±1	25mm/s±6 mm/s	1							
Solderability Test	More than 95% of terminal electrode should be covered with solder.	Preheat: 150°C ,60sec. ◦ Solder: Sn99.5%-Cu0. 5% ◦ Temperature: 245±5°C ◦ Flux for lead free: Rosin. 9.5% ◦ Dip time: 4±1sec ◦ Depth: completely cover the termination								
Reliability Test										
Life Test	Appearance : No damage. Inductance : within±10% of initial value RDC : within ±15% of initial value and shall not exceed the specification value	Preconditioning:Run through IR reflow for 2 times.(IPC/JEDEC J-STD-020DClassification Reflow Profiles Temperature : 125±2°C (Bead) Temperature : 85±2°C (Inductor) Applied current : rated current Duration : 1000±12hrs Measured at room temperature after placing for 24±2 hrs								
Thermal shock		Preconditioning:Run through IR reflow for 2 times.(IPC/JEDEC J-STD-020DClassification Reflow Profiles Step1 : -40±2°C 30±5min Step2 : 25±2°C ≤0.5min Step3 : 105±2°C 30±5min Number of cycles : 500 Measured at room temprature after placing for 24±2 hrs								
Humidity Resistance Test		Preconditioning:Run through IR reflow for 2 times.(IPC/JEDEC J-STD-020DClassification Reflow Profiles Humidity : 85±2% R.H, Temperature : 85°C±2°C Duration : 1000hrs Min. with 100% rated current Measured at room temperature after placing for 24±2 hrs								

<p>Vibration Test</p>		<p>Preconditioning: Run through IR reflow for 2 times (IPC/JEDEC J-STD-020D Classification Reflow Profiles) Oscillation Frequency: 10~2K~10Hz for 20 minutes Equipment : Vibration checker Total Amplitude: 1.52mm±10% Testing Time : 12 hours(20 minutes, 12 cycles each of 3 orientations) *</p>
-----------------------	--	----------------------------------------------------------------------------------------------------------------------------------------------------------------------------------------------------------------------------------------------------------------------------------------------------------------------------------------------------------------------------------------

8. Soldering and Mounting

8-1. Soldering

Mildly activated rosin fluxes are preferred. TAI-TECH terminations are suitable for all wave and re-flow soldering systems. If hand soldering cannot be avoided, the preferred technique is the utilization of hot air soldering tools.

8-1.1 Solder re-flow:

Recommended temperature profiles for re-flow soldering in Figure 1.

8-1.2 Soldering Iron(Figure 2):

Products attachment with a soldering iron is discouraged due to the inherent process control limitations. In the event that a soldering iron must be employed the following precautions are recommended.

- Preheat circuit and products to 150°C
- Never contact the ceramic with the iron tip
- Use a 20 watt soldering iron with tip diameter of 1.0mm
- 355°C tip temperature (max)
- 1.0mm tip diameter (max)
- Limit soldering time to 4~5 sec.

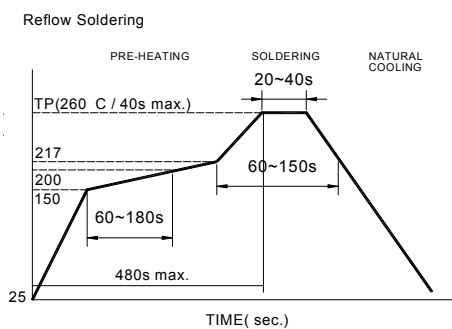

Reflow times: 3 times max.

Fig.1

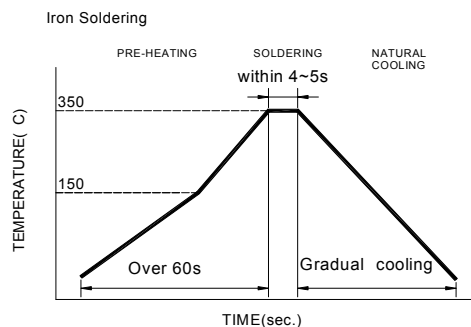

Iron Soldering times: 1 times max.

Fig.2

8-2. Recommended PC Board Pattern

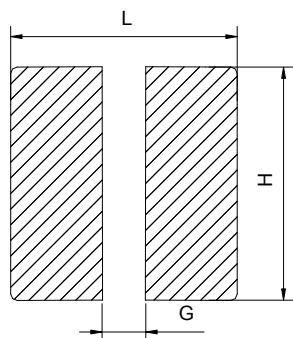

L(mm)	G(mm)	H(mm)
3.2	1.0	3.2

9. Packaging Information

9-1. Reel Dimension

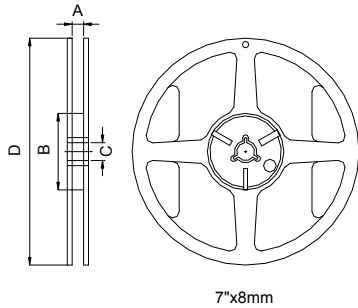

Type	A(mm)	B(mm)	C(mm)	D(mm)
7"x8mm	8.4±1.0	50 min.	13±0.8	178±2

9-2. Tape Dimension / 8mm

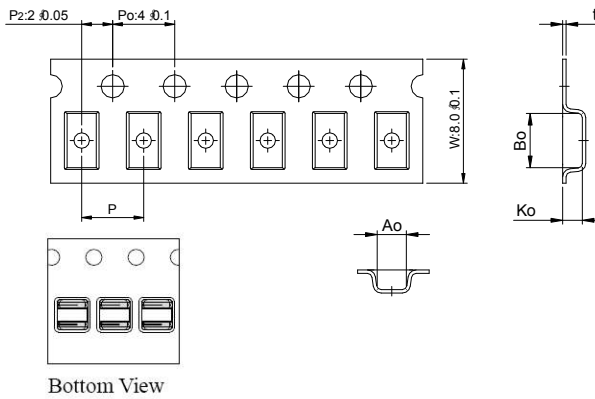

Series	Size	Bo(mm)	Ao(mm)	Ko(mm)	P(mm)	t(mm)
HPC	3015	3.2±0.05	3.2±0.05	1.70±0.2	4.0±0.05	0.23±0.05

9-3. Packaging Quantity

Chip size	3015
Chip / Reel	2000

9-4. Tearing Off Force

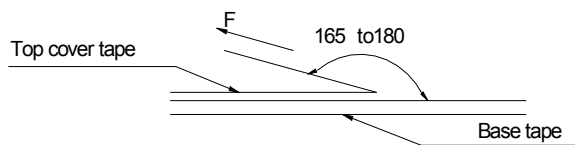

The force for tearing off cover tape is 15 to 80 grams in the arrow direction under the following conditions.

Room Temp. (°C)	Room Humidity (%)	Room atm (hPa)	Tearing Speed mm/min
5~35	45~85	860~1060	300

Application Notice

- Storage Conditions

To maintain the solderability of terminal electrodes:

1. TAI-TECH products meet IPC/JEDEC J-STD-020D standard-MSL, level 1.
2. Temperature and humidity conditions: Less than 40°C and 60% RH.
3. Recommended products should be used within 12 months from the time of delivery.
4. The packaging material should be kept where no chlorine or sulfur exists in the air.

- Transportation

1. Products should be handled with care to avoid damage or contamination from perspiration and skin oils.
2. The use of tweezers or vacuum pick up is strongly recommended for individual components.
3. Bulk handling should ensure that abrasion and mechanical shock are minimized.

X-ON Electronics

Largest Supplier of Electrical and Electronic Components

Click to view similar products for [Fixed Inductors](#) category:

Click to view products by [TAITEC](#) manufacturer:

Other Similar products are found below :

[CR32NP-151KC](#) [CR32NP-180KC](#) [CR32NP-181KC](#) [CR32NP-1R5MC](#) [CR32NP-390KC](#) [CR32NP-3R9MC](#) [CR32NP-680KC](#) [CR32NP-820KC](#) [CR32NP-8R2MC](#) [CR43NP-390KC](#) [CR43NP-560KC](#) [CR43NP-680KC](#) [CR54NP-181KC](#) [CR54NP-470LC](#) [CR54NP-820KC](#) [CR54NP-8R5MC](#) [70F224AI](#) [MGDQ4-00004-P](#) [MHL1ECTTP18NJ](#) [MHQ1005P10NJ](#) [MHQ1005P1N0S](#) [MHQ1005P2N4S](#) [MHQ1005P3N6S](#) [MHQ1005P5N1S](#) [MHQ1005P8N2J](#) [PE-51506NL](#) [PE-53601NL](#) [PE-53602NL](#) [PE-53630NL](#) [PE-53824SNLT](#) [PE-92100NL](#) [PG0434.801NLT](#) [PG0936.113NLT](#) [9220-20](#) [9310-16](#) [PM06-2N7](#) [PM06-39NJ](#) [A01TK](#) [1206CS-471XJ](#) [HC2LP-R47-R](#) [HC2-R47-R](#) [HC3-2R2-R](#) [HCF1305-3R3-R](#) [1206CS-151XG](#) [RCH664NP-140L](#) [RCH664NP-4R7M](#) [RCH8011NP-221L](#) [RCP1317NP-332L](#) [RCP1317NP-391L](#) [RCR1010NP-470M](#)