

Specification for Approval

Date: 2017/04/12

Customer : 深圳台慶

TAI-TECH P/N: HPC4012TF-SERIES

CUSTOMER P/N: _____

DESCRIPTION: _____

QUANTITY: _____ pcs

REMARK:		
Customer Approval Feedback		

- 西北臺慶科技股份有限公司
 TAI-TECH Advanced Electronics Co., Ltd
Headquarter:
 NO.1 YOU 4TH ROAD, YOUTH INDUSTRIAL DISTRICT, YANG-MEI,
 TAO-YUAN HSIEN, TAIWAN, R.O.C.
 TEL: +886-3-4641148 FAX: +886-3-4643565
 http://www.tai-tech.com.tw
 E-mail: sales@tai-tech.com.tw

- Office:**
 深圳辦公室
 11BC, Building B Fortune Plaza, NO.7002, Shennan Avenue, Futian
 District Shenzhen
 TEL: +86-755-23972371 FAX: +86-755-23972340

- 臺慶精密電子(昆山)有限公司
 TAI-TECH ADVANCED ELECTRONICS(KUNSHAN) CO., LTD
 SHINWHA ROAD, KUNJIA HI-TECH INDUSTRIAL PARK, KUN-SHAN,
 JIANG-SU, CHINA
 TEL: +86-512-57619396 FAX: +86-512-57619688
 E-mail: sales@tai-tech.cn

- Office:**
 北欣國際有限公司
 NORTH STAR INTERNATIONAL LIMITED
 TEL: +86-512-57619396 FAX: +86-512-57619688

- 慶邦電子元器件(泗洪)有限公司
 TAIPAQ ELECTRONICS (SIHONG) CO., LTD
 Sihong development zone Suqian City, Jiangsu , CHINA.
 TEL: +86-527-88601191 FAX: +86-527-88601190
 E-mail: sales@taipaq.cn

Sales Dep.

APPROVED	CHECKED
管哲頌 Eric Kuan	曾詩涵 Angela Tseng

R&D Center

APPROVED	CHECKED	DRAWN
羅宜春	梁周虎	張光

Power Inductor

HPC4012TF-SERIES

1. Features

1. This specification applies Low Profile Power Inductors.
2. 100% Lead(Pb) & Halogen-Free and RoHS compliant.



2. Dimension

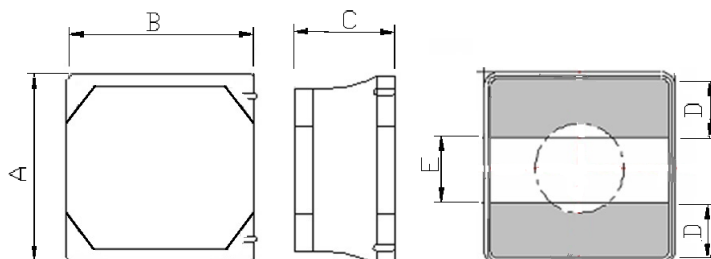

Series	A(mm)	B(mm)	C(mm)	D(mm)	E(mm)
HPC4012TF	4.0±0.2	4.0±0.2	1.2 max.	1.2 ref.	1.6 ref.

Units: mm

3. Part Numbering

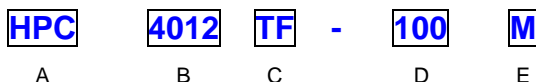

- A: Series
- B: Dimension
- C: Lead Free
- D: Inductance 100=10uH
- E: Inductance Tolerance M=±20% ; Y=±30%

4. Specification

TAI-TECH Part Number	Inductance (uH)	Tolerance (%)	Test Frequency (Hz)	SRF (MHz) typ.	DCR (Ω) ±20%	I sat (A)typ.	I sat (A)Max.	I rms (A)typ.	I rms (A)Max.
HPC4012TF -1R0Y	1.0	±30%	1V100K	100	0.042	3.30	2.80	2.50	2.20
HPC4012TF -2R2M	2.2	±20%	1V100K	70	0.060	1.95	1.65	2.20	1.90
HPC4012TF -3R3M	3.3	±20%	1V100K	60	0.070	1.60	1.40	1.90	1.70
HPC4012TF -4R7M	4.7	±20%	1V100K	45	0.095	1.40	1.20	1.70	1.50
HPC4012TF -6R8M	6.8	±20%	1V100K	35	0.125	1.10	0.90	1.50	1.30
HPC4012TF -100M	10	±20%	1V100K	30	0.180	1.00	0.80	1.30	1.10
HPC4012TF -150M	15	±20%	1V100K	24	0.260	0.80	0.65	0.95	0.75
HPC4012TF -220M	22	±20%	1V100K	18	0.400	0.60	0.50	0.72	0.62

Note:

- Isat : Based on inductance change (ΔL/L0 : ≤30%) @ ambient temp. 25°C
- Irms : Based on temperature rise (ΔT : 40°C typ.) max

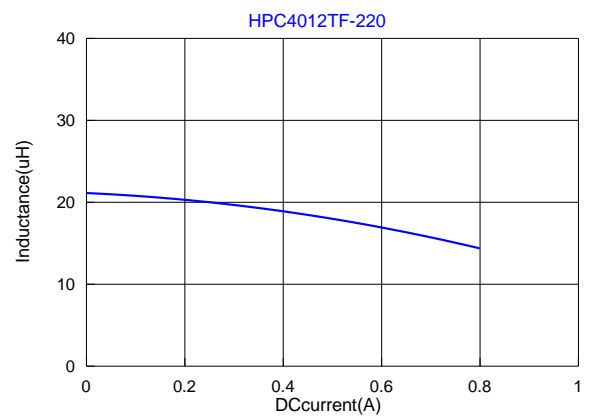
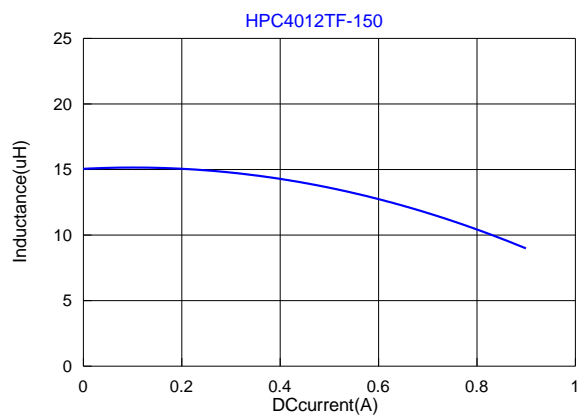
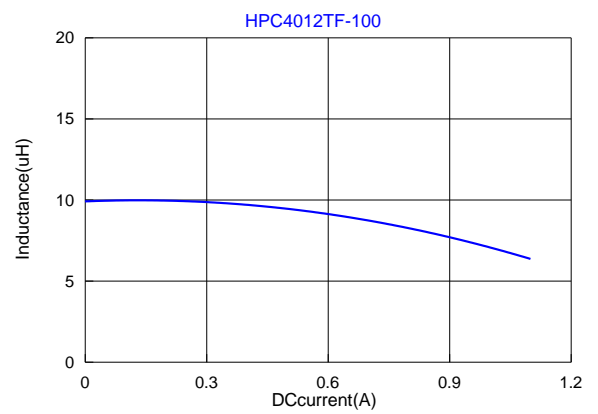
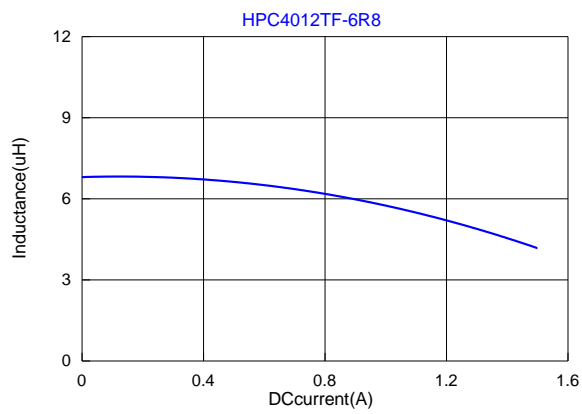
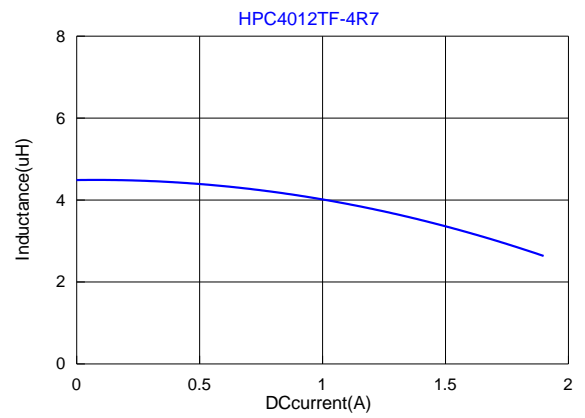
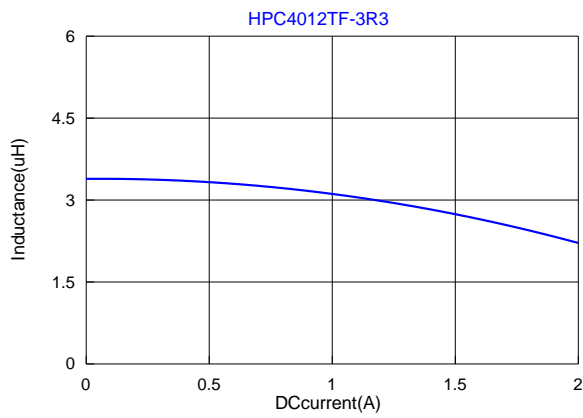
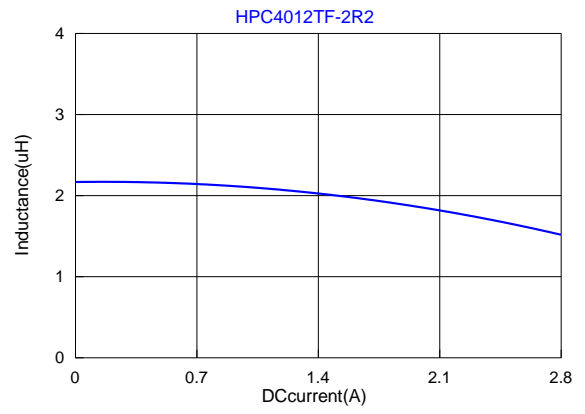
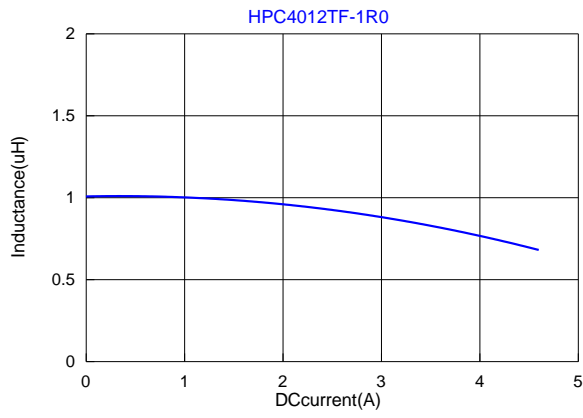

Void appearance tolerance Limit

Size of voids occurring to coating resin is specified below.

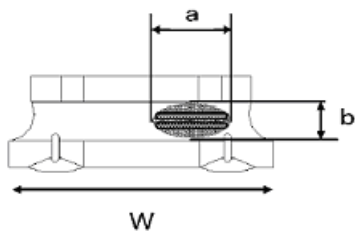

Appearance of exposed wire tolerance limit :

1. Width direction (dimension a) : Acceptable when $a \leq w/2$
Nonconforming when $a > w/2$
2. Length direction (dimension b) : Dimension b is not specified.
3. The total area of exposed wire occurring to each sides is not greater than 50% of coating resin area, and is acceptable.

External appearance criterion for exposed wire

Exposed end of the winding wire at the secondary side should be 2mm and below.

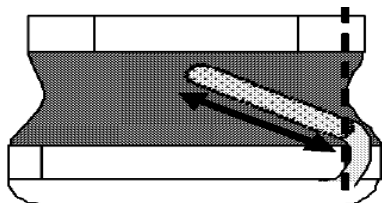

5. Material

No.	Description	Specification
a.	Core	Ferrite Core
b.	Wire	Enameled Copper Wire
c.	Glue	Epoxy / Epoxy with magnetic powder
d.	Terminal	Ag/Ni/Sn

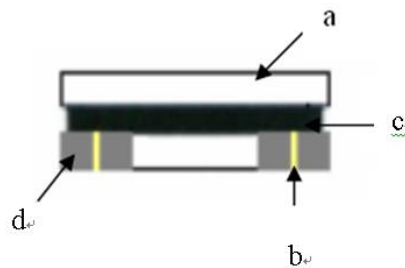

6. Reliability and Test Condition

Item	Performance	Test Condition
Operating temperature	-40~+125℃ (Including self - temperature rise)	
Storage temperature	-40~+125℃ (on board)	
Electrical Performance Test		
Inductance	Refer to standard electrical characteristics list.	HP4284A,CH11025,CH3302,CH1320,CH1320S LCR Meter.
DCR		CH16502,Agilent33420A Micro-Ohm Meter.
Saturation Current (Isat)	$\Delta L \leq 30\%$ typical.	Saturation DC Current (Isat) will cause L0 to drop $\Delta L(\%)$ (keep quickly).
Heat Rated Current (Irms)	Approximately $\Delta T \leq 40^\circ\text{C}$	Heat Rated Current (Irms) will cause the coil temperature rise $\Delta T(^\circ\text{C})$ without core loss. 1.Applied the allowed DC current(keep 1 min.). 2.Temperature measured by digital surface thermometer
Reliability Test		
Life Test	Appearance : No damage. Inductance : within $\pm 10\%$ of initial value Q : Shall not exceed the specification value. RDC : within $\pm 15\%$ of initial value and shall not exceed the specification value	Preconditioning: Run through IR reflow for 2 times.(IPC/JEDEC J-STD-020DClassification Reflow Profiles) Temperature : $125 \pm 2^\circ\text{C}$ (Inductor) Applied current : rated current Duration : 1000 ± 12 hrs Measured at room temperature after placing for 24 ± 2 hrs
Load Humidity		Preconditioning: Run through IR reflow for 2 times.(IPC/JEDEC J-STD-020DClassification Reflow Profiles) Humidity : $85 \pm 2\%$ R.H. Temperature : $85 \pm 2^\circ\text{C}$ Duration : 1000hrs Min. with 100% rated current Measured at room temperature after placing for 24 ± 2 hrs
Moisture Resistance		Preconditioning: Run through IR reflow for 2 times.(IPC/JEDEC J-STD-020DClassification Reflow Profiles) 1. Baked at 50°C for 25hrs, measured at room temperature after placing for 4 hrs. 2. Raise temperature to $65 \pm 2^\circ\text{C}$ 90-100%RH in 2.5hrs, and keep 3 hours, cool down to 25°C in 2.5hrs. 3. Raise temperature to $65 \pm 2^\circ\text{C}$ 90-100%RH in 2.5hrs, and keep 3 hours, cool down to 25°C in 2.5hrs,keep at 25°C for 2 hrs then keep at -10°C for 3 hrs 4. Keep at 25°C 80-100%RH for 15min and vibrate at the frequency of 10 to 55 Hz to 10 Hz, measure at room temperature after placing for 1~2 hrs.
Thermal shock		Preconditioning: Run through IR reflow for 2 times.(IPC/JEDEC J-STD-020DClassification Reflow Profiles) Condition for 1 cycle Step1 : $-40 \pm 2^\circ\text{C}$ 30 \pm 5min Step2 : $25 \pm 2^\circ\text{C}$ \leq 0.5min Step3 : $125 \pm 2^\circ\text{C}$ 30 \pm 5min Number of cycles : 500 Measured at room temperature after placing for 24 ± 2 hrs
Vibration		Oscillation Frequency: 10~2K~10Hz for 20 minutes Equipment : Vibration checker Total Amplitude:1.52mm \pm 10% Testing Time : 12 hours(20 minutes, 12 cycles each of 3 orientations) *

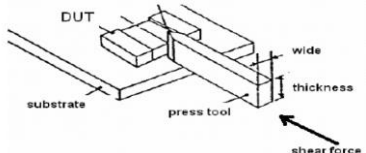
Item	Performance	Test Condition															
Shock	Appearance : No damage. Inductance : within±10% of initial value Q : Shall not exceed the specification value.	<table border="1" data-bbox="991 230 1409 353"> <thead> <tr> <th>Type</th> <th>Peak value (g' s)</th> <th>Normal duration (D) (ms)</th> <th>Wave form</th> <th>Velocity change (V)/ft/sec</th> </tr> </thead> <tbody> <tr> <td>SMD</td> <td>50</td> <td>11</td> <td>Half-sine</td> <td>11.3</td> </tr> <tr> <td>Lead</td> <td>50</td> <td>11</td> <td>Half-sine</td> <td>11.3</td> </tr> </tbody> </table> shocks in each direction along 3 perpendicular axes.	Type	Peak value (g' s)	Normal duration (D) (ms)	Wave form	Velocity change (V)/ft/sec	SMD	50	11	Half-sine	11.3	Lead	50	11	Half-sine	11.3
Type	Peak value (g' s)	Normal duration (D) (ms)	Wave form	Velocity change (V)/ft/sec													
SMD	50	11	Half-sine	11.3													
Lead	50	11	Half-sine	11.3													
Bending	RDC : within ±15% of initial value and shall not exceed the specification value	Shall be mounted on a FR4 substrate of the following dimensions: >=0805:40x100x1.2mm <0805:40x100x0.8mm Bending depth: >=0805inch(2012mm):1.2mm <0805 inch(2012mm):0.8mm duration of 10 sec.															
Soderability	More than 95% of the terminal electrode should be covered with solder °	Preheat: 150°C ,60sec. ° Solder: Sn96.5% Ag3% Cu0.5% Temperature: 245±5°C ° Flux for lead free: Rosin. 9.5% ° Dip time: 4±1sec ° Depth: completely cover the termination															
Resistance to Soldering Heat	Appearance : No damage. Inductance : within±10% of initial value Q : Shall not exceed the specification value. RDC : within ±15% of initial value and shall not exceed the specification value	Number of heat cycles: 1 <table border="1" data-bbox="991 748 1370 882"> <thead> <tr> <th>Temperature (°C)</th> <th>Time(s)</th> <th>Temperature ramp/immersion and emersion rate</th> </tr> </thead> <tbody> <tr> <td>260 ±5(solder temp)</td> <td>10 ±1</td> <td>25mm/s ±6 mm/s</td> </tr> </tbody> </table>	Temperature (°C)	Time(s)	Temperature ramp/immersion and emersion rate	260 ±5(solder temp)	10 ±1	25mm/s ±6 mm/s									
Temperature (°C)	Time(s)	Temperature ramp/immersion and emersion rate															
260 ±5(solder temp)	10 ±1	25mm/s ±6 mm/s															
Terminal Strength		Preconditioning:Run through IR reflow for 2 times.(IPC/JEDEC J-STD-020DClassification Reflow Profiles With the component mounted on a PCB with the device to be tested, apply a force (>0805 inch(2012mm):1kg , <=0805 inch(2012mm):0.5kg)to the side of a device being tested. This force shall be applied for 60 +1 seconds. Also the force shall be applied gradually as not to apply a shock to the component being tested. 															

7. Soldering and Mounting

7-1. Soldering

Mildly activated rosin fluxes are preferred. TAI-TECH terminations are suitable for all wave and re-flow soldering systems. If hand soldering cannot be avoided, the preferred technique is the utilization of hot air soldering tools.

7-1.1 Solder re-flow:

Recommended temperature profiles for re-flow soldering in Figure 1.

7-1.2 Soldering Iron(Figure 2):

Products attachment with a soldering iron is discouraged due to the inherent process control limitations. In the event that a soldering iron must be employed the following precautions are recommended.

- Preheat circuit and products to 150°C
- Never contact the ceramic with the iron tip
- Use a 20 watt soldering iron with tip diameter of 1.0mm
- 355°C tip temperature (max)
- 1.0mm tip diameter (max)
- Limit soldering time to 4-5 sec.

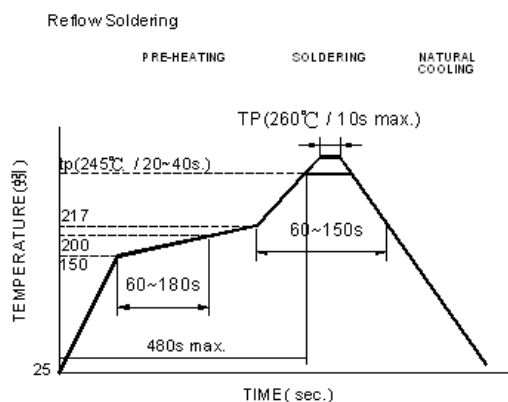

Reflow times: 3 times max.

Fig.1

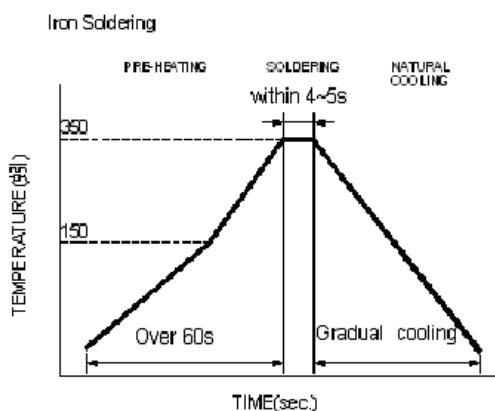

Iron Soldering times: 1 times max.

Fig.2

7-2. Recommended PC Board Pattern

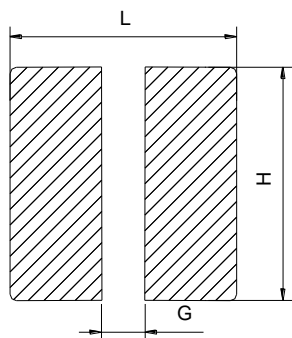

L(mm)	G(mm)	H(mm)
4.2	1.2	4.2

8. Packaging Information

8-1. Reel Dimension

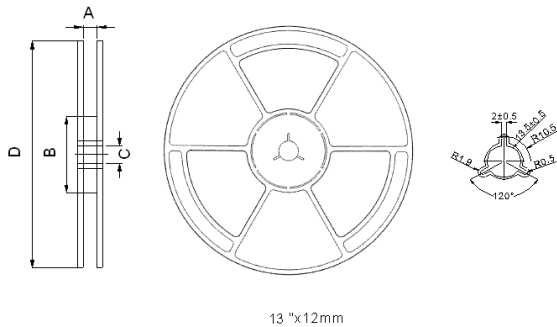

Type	A(mm)	B(mm)	C(mm)	D(mm)
13"x12mm	12±1.5	100±0.5	13.2±0.5	330±0.5

8-2. Tape Dimension / 12mm

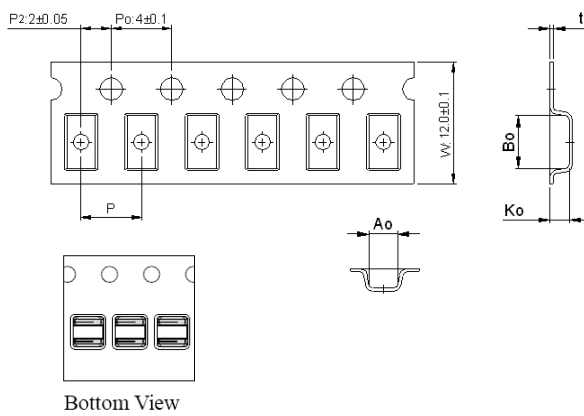

Series	Size	Bo(mm)	Ao(mm)	Ko(mm)	P(mm)	t(mm)
HPC	4012	4.35±0.1	4.50±0.1	1.55±0.1	8.0±0.10	0.25±0.05

8-3. Packaging Quantity

Chip size	4012
Chip / Reel	4500

8-4. Tearing Off Force

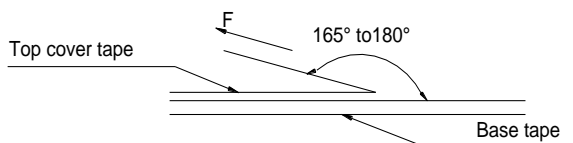

The force for tearing off cover tape is 15 to 80 grams in the arrow direction under the following conditions.

Room Temp. (°C)	Room Humidity (%)	Room atm (hPa)	Tearing Speed mm/min
5-35	45-85	860-1060	300

Application Notice

- Storage Conditions(component level)
 - To maintain the solderability of terminal electrodes:
 1. TAI-TECH products meet IPC/JEDEC J-STD-020D standard-MSL, level 1.
 2. Temperature and humidity conditions: Less than 40°C and 60% RH.
 3. Recommended products should be used within 12 months from the time of delivery.
 4. The packaging material should be kept where no chlorine or sulfur exists in the air.
- Transportation
 1. Products should be handled with care to avoid damage or contamination from perspiration and skin oils.
 2. The use of tweezers or vacuum pick up is strongly recommended for individual components.
 3. Bulk handling should ensure that abrasion and mechanical shock are minimized.

X-ON Electronics

Largest Supplier of Electrical and Electronic Components

Click to view similar products for [taitec](#) manufacturer:

Other Similar products are found below :

[TMPC1205HP-4R7MG-D](#) [TMPC0624H-4R7MG-D](#) [TMPC0402HP-R10YG-Z02](#) [TMPC0502HP-R68MG-D](#) [TMPC0518HP-R47MG-D](#)
[TMPC1707HP-3R3MG-D](#) [HPC6045NF-1R0M](#) [TMPA0603S-1R5MN-D](#) [TMPC1004H-470MG-D](#) [TMPC0603H-1R0MG-D](#) [HPC5020CF-2R2Y](#) [TMPA0603S-330MN-D](#) [HPC6045NF-100MTH](#) [TMPC0618H-1R0MG-D](#) [WCM4532F2SF-601T15](#) [TMPA0605S-4R7MN-D](#)
[TPRHC1207F-470M](#) [WCM3216F2SV-102T02](#) [TMPF0603A-3R3MN-D](#) [TMPC1265HP-100MG-D](#) [TMPC0502HP-6R8MG-D](#)
[TMPC1265HP-2R2MG-D](#) [UHP252012NF-R47M](#) [HCB3216KF-501T30](#) [AHP201610TF-R68M-1](#) [HPC5020NF-1R0Y](#) [TMPC0412HP-R12MG-Z03](#) [TMPC1206HP-101MG-D](#) [HPC5040NF-3R3M](#) [HPC8040NF-8R2M](#) [TMPC1205HP-330MG-D](#) [TMPA1206SP-100MN-D](#)
[UHP252012NF-1R0MT01](#) [HPC5040NF-2R2M](#) [HSF2012F2SF-670T04](#) [TMPC1235HP-2R2MG-D](#) [TMPC1004H-1R0MG-D](#) [TMPA1004S-1R0MN-D](#) [TMPC0615H-220MG-D](#) [DFP201610TF-R47M](#) [AHP201610AF-2R2M](#) [TMPC0512HP-4R7MG-D](#) [TMPC0602H-220MG-D](#)
[WCM3216F2SF-102T02](#) [TMPC0624H-R22MG-D](#) [TMPC1265HP-R82MG-D](#) [TMPC0603H-6R8MG-D](#) [FCM2012CF-600T07](#) [FCM2012CF-221T04](#) [FCI2012F-R12K](#)