

Specification for Approval

Date: 2019/11/28

Customer : XIANGGAO

TAI-TECH P/N: UHP252012BF-1R5M

CUSTOMER P/N: _____

DESCRIPTION: _____

QUANTITY: _____ pcs

REMARK:		
Customer Approval Feedback		

西北臺慶科技股份有限公司
 TAI-TECH Advanced Electronics Co., Ltd
 Headquarter:
 NO.1 YOU 4TH ROAD, YOUTH INDUSTRIAL DISTRICT, YANG-MEI,
 TAO-YUAN HSIEN, TAIWAN, R.O.C.
 TEL: +886-3-4641148 FAX: +886-3-4643565
 http://www.tai-tech.com.tw
 E-mail: sales@tai-tech.com.tw

Office:
 深圳辦公室
 11BC, Building B Fortune Plaza, NO.7002, Shennan Avenue, Futian
 District Shenzhen
 TEL: +86-755-23972371 FAX: +86-755-23972340

臺慶精密電子(昆山)有限公司
 TAI-TECH ADVANCED ELECTRONICS(KUNSHAN) CO., LTD
 SHINWHA ROAD, KUNJIA HI-TECH INDUSTRIAL PARK, KUN-SHAN,
 JIANG-SU, CHINA
 TEL: +86-512-57619396 FAX: +86-512-57619688
 E-mail: sales@tai-tech.cn

慶邦電子元件(泗洪)有限公司
 TAIPAQ ELECTRONICS (SIHONG) CO., LTD
 JIN SHA JIANG ROAD , CONOMIC DEVELOPMENT ZONE SIHONG ,
 JIANGSU , CHINA.
 TEL: +86-527-88601191 FAX: +86-527-88601190
 E-mail: sales@taipaq.cn

Sales Dep.

APPROVED	CHECKED
陳暉治 Sable Chen	曾詩涵 Angela Tseng

R&D Center

APPROVED	CHECKED	DRAWN
羅宜春	梁周虎	梁艷艷

Power Inductor

UHP252012BF-1R5M

1. Features

1. This specification applies Low Profile Power Inductors.
2. 100% Lead(Pb) & Halogen-Free and RoHS compliant.
3. Operating temperature :-40~+125°C (Including self - temperature rise)



2. Dimension

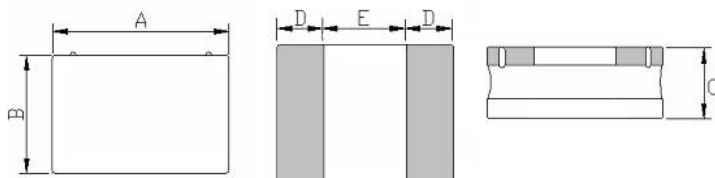

Series	A(mm)	B(mm)	C(mm)	D(mm)	E(mm)
UHP252012BF	2.5 -0.1/+0.2	2.0 -0.1/+0.2	1.2 max.	0.85 ref.	0.80 ref.

3. Part Numbering

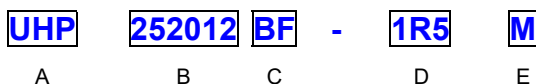

- A: Series
- B: Dimension
- C: Lead Free Material
- D: Inductance 1R5=1.5uH
- E: Inductance Tolerance M=±20%

4. Specification

TAI-TECH Part Number	Inductance (uH)	Tolerance (%)	Test Frequency (Hz)	DCR (Ω) ±20%	I sat (A) typ.	I sat (A) Max.	I rms (A) typ	I rms (A) Max.
UHP252012BF-1R5M	1.50	±20%	0.1V/1M	0.063	2.30	2.05	2.20	1.95

Note:

Isat : Saturation Current (Isat) will cause L0 to drop approximately 30%.

Irms : Heat Rated Current (Irms) will cause the coil temperature rise approximately ΔT of 40°C

5. Material List

No.	Description	Specification
a.	Core	Ferrite Core
b.	Wire	Enameled Copper Wire
c.	Glue	Epoxy with magnetic powder
d.	Terminal	Ag/Ni/Sn

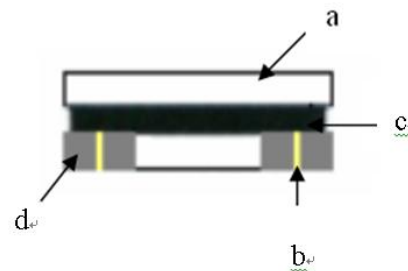

Void appearance tolerance Limit

Size of voids occurring to coating resin is specified below.

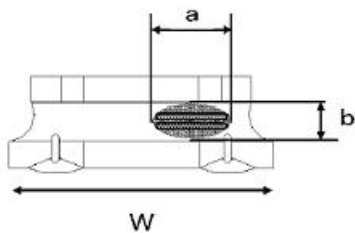

Appearance of exposed wire tolerance limit :

1. Width direction (dimension a) : Acceptable when $a \leq w/2$
Nonconforming when $a > w/2$
2. Length direction (dimension b) : Dimension b is not specified.
3. The total area of exposed wire occurring to each sides is not greater than 50% of coating resin area, and is acceptable.

External appearance criterion for exposed wire

Exposed end of the winding wire at the secondary side should be 2mm and below.

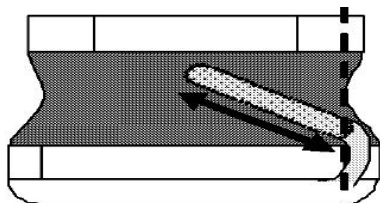

6. Reliability and Test Condition

Item	Performance	Test Condition
Operating temperature	-40~+125°C (Including self - temperature rise)	
Storage temperature	1. -10~+40°C, 50~60%RH (Product with taping) 2. -40~+125°C (on board)	
Electrical Performance Test		
Inductance	Refer to standard electrical characteristics list.	HP4284A, CH11025, CH3302, CH1320, CH1320S LCR Meter.
DCR		CH16502, Agilent33420A Micro-Ohm Meter.
Saturation Current (Isat)	Approximately Δ L30% .	Saturation DC Current (Isat) will cause L0 to drop Δ L(%) (keep quickly).
Heat Rated Current (Irms)	Approximately Δ T40°C	Heat Rated Current (Irms) will cause the coil temperature rise Δ T(°C) without core loss. 1. Applied the allowed DC current (keep 1 min.). 2. Temperature measured by digital surface thermometer
Reliability Test		
Life Test	Appearance: No damage. Inductance: within \pm 10% of initial value Q: Shall not exceed the specification value. RDC: within \pm 15% of initial value and shall not exceed the specification value	Preconditioning: Run through IR reflow for 2 times. (IPC/JEDEC J-STD-020D Classification Reflow Profiles) Temperature: 125 \pm 2°C (Inductor) Applied current: rated current Duration: 1000 \pm 12hrs Measured at room temperature after placing for 24 \pm 2 hrs
Load Humidity		Preconditioning: Run through IR reflow for 2 times. (IPC/JEDEC J-STD-020D Classification Reflow Profiles) Humidity: 85 \pm 2% R.H. Temperature: 85 \pm 2°C Duration: 1000hrs Min. with 100% rated current Measured at room temperature after placing for 24 \pm 2 hrs
Moisture Resistance		Preconditioning: Run through IR reflow for 2 times. (IPC/JEDEC J-STD-020D Classification Reflow Profiles) 1. Baked at 50°C for 25hrs, measured at room temperature after placing for 4 hrs. 2. Raise temperature to 65 \pm 2°C 90-100%RH in 2.5hrs, and keep 3 hours, cool down to 25°C in 2.5hrs. 3. Raise temperature to 65 \pm 2°C 90-100%RH in 2.5hrs, and keep 3 hours, cool down to 25°C in 2.5hrs, keep at 25°C for 2 hrs then keep at -10°C for 3 hrs 4. Keep at 25°C 80-100%RH for 15min and vibrate at the frequency of 10 to 55 Hz to 10 Hz, measure at room temperature after placing for 1~2 hrs.
Thermal shock		Preconditioning: Run through IR reflow for 2 times. (IPC/JEDEC J-STD-020D Classification Reflow Profiles) Condition for 1 cycle Step1: -40 \pm 2°C 30 \pm 5min Step2: 25 \pm 2°C \leq 0.5min Step3: 125 \pm 2°C 30 \pm 5min Number of cycles: 500 Measured at room temperature after placing for 24 \pm 2 hrs
Vibration		Preconditioning: Run through IR reflow for 2 times. (IPC/JEDEC J-STD-020D Classification Reflow Profiles) Oscillation Frequency: 10Hz~2KHz~10Hz for 20 minutes Equipment: Vibration checker Total Amplitude: 10g Testing Time: 12 hours (20 minutes, 12 cycles each of 3 orientations).

Item	Performance	Test Condition														
Bending	Appearance : No damage. Impedance : within±15% of initial value Inductance : within±10% of initial value Q : Shall not exceed the specification value. RDC : within ±15% of initial value and shall not exceed the specification value	Shall be mounted on a FR4 substrate of the following dimensions: >=0805 inch(2012mm):40x100x1.2mm <0805 inch(2012mm):40x100x0.8mm Bending depth: >=0805 inch(2012mm):1.2mm <0805 inch(2012mm):0.8mm duration of 10 sec.														
Shock		<table border="1"> <thead> <tr> <th>Type</th> <th>Peak value (g's)</th> <th>Normal duration (D) (ms)</th> <th>Wave form</th> <th>Velocity change (V)ft/sec</th> </tr> </thead> <tbody> <tr> <td>SMD</td> <td>50</td> <td>11</td> <td>Half-sine</td> <td>11.3</td> </tr> <tr> <td>Lead</td> <td>50</td> <td>11</td> <td>Half-sine</td> <td>11.3</td> </tr> </tbody> </table>	Type	Peak value (g's)	Normal duration (D) (ms)	Wave form	Velocity change (V)ft/sec	SMD	50	11	Half-sine	11.3	Lead	50	11	Half-sine
Type	Peak value (g's)	Normal duration (D) (ms)	Wave form	Velocity change (V)ft/sec												
SMD	50	11	Half-sine	11.3												
Lead	50	11	Half-sine	11.3												
Solder ability	More than 95% of the terminal electrode should be covered with solder.	Preheat: 150°C,60sec.。 Solder: Sn96.5% Ag3% Cu0.5% Temperature: 245±5°C。 Flux for lead free: Rosin. 9.5%。 Dip time: 4±1sec。 Depth: completely cover the termination Depth: completely cover the termination														
Resistance to Soldering Heat		<table border="1"> <thead> <tr> <th>Temperature(°C)</th> <th>Time(s)</th> <th>Temperature ramp/immersion and emersion rate</th> <th>Number of heat cycles</th> </tr> </thead> <tbody> <tr> <td>260 ±5 (solder temp)</td> <td>10 ±1</td> <td>25mm/s ±6 mm/s</td> <td>1</td> </tr> </tbody> </table>	Temperature(°C)	Time(s)	Temperature ramp/immersion and emersion rate	Number of heat cycles	260 ±5 (solder temp)	10 ±1	25mm/s ±6 mm/s	1						
Temperature(°C)	Time(s)	Temperature ramp/immersion and emersion rate	Number of heat cycles													
260 ±5 (solder temp)	10 ±1	25mm/s ±6 mm/s	1													
Terminal Strength	Appearance : No damage. Impedance : within±15% of initial value Inductance : within±10% of initial value Q : Shall not exceed the specification value. RDC : within ±15% of initial value and shall not exceed the specification value e	Preconditioning: Run through IR reflow for 2 times.(IPC/JEDEC J-STD-020DClassification Reflow Profiles With the component mounted on a PCB with the device to be tested, apply a force(>0805:1kg , <=0805:0.5kg)to the side of a device being tested. This force shall be applied for 60 +1 seconds Also the force shall be applied gradually as not to apply a shock to the component being tested.														

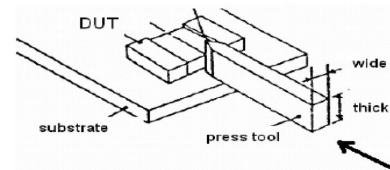

Note : When there are questions concerning measurement result : measurement shall be made after 48 ± 2 hours of recovery under the standard condition

7. Soldering and Mounting

7-1. Soldering

Mildly activated rosin fluxes are preferred. TAI-TECH terminations are suitable for all wave and re-flow soldering systems. If hand soldering cannot be avoided, the preferred technique is the utilization of hot air soldering tools.

7-1.1 Solder re-flow:

Recommended temperature profiles for re-flow soldering in Figure 1.

7-1.2 Soldering Iron(Figure 2):

Products attachment with a soldering iron is discouraged due to the inherent process control limitations. In the event that a soldering iron must be employed the following precautions are recommended.

- Preheat circuit and products to 150°C
- Never contact the ceramic with the iron tip
- Use a 20 watt soldering iron with tip diameter of 1.0mm
- 355°C tip temperature (max)
- 1.0mm tip diameter (max)
- Limit soldering time to 4~5 sec.

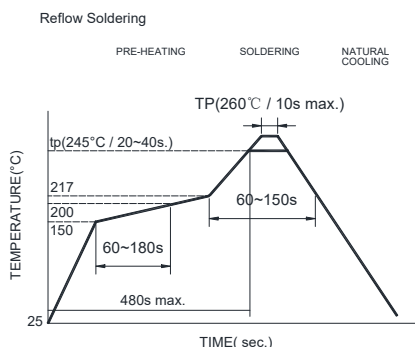

Reflow times: 3 times max.

Fig.1

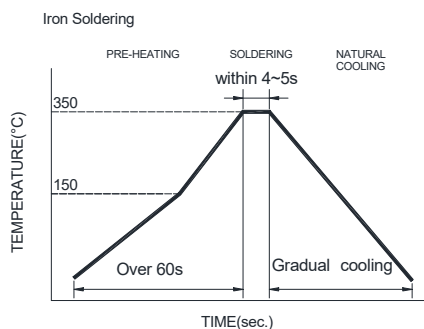

Iron Soldering times: 1 times max.

Fig.2

7-2. Recommended PC Board Pattern

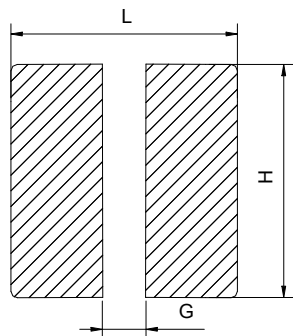

L(mm)	G(mm)	H(mm)
2.6	0.8	2.1

8. Packaging Information

8-1. Reel Dimension

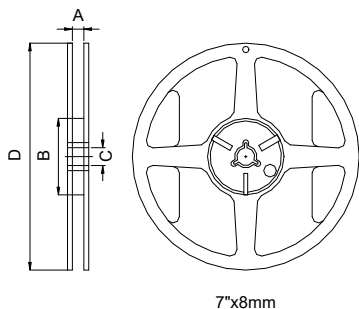

Type	A(mm)	B(mm)	C(mm)	D(mm)
7"x8mm	8.4±1.0	50 min.	13±0.8	178±2

8-2. Tape Dimension / 8mm

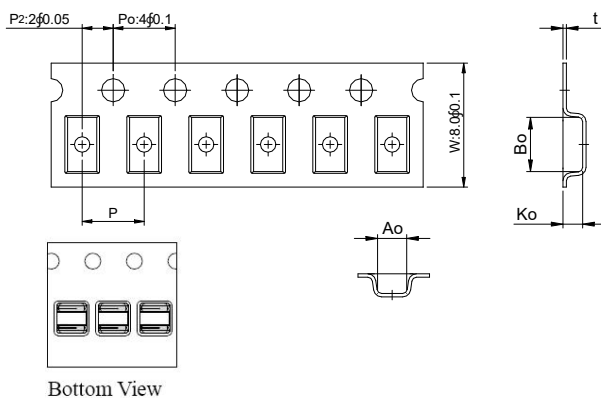

Series	Size	Bo(mm)	Ao(mm)	Ko(mm)	P(mm)	t(mm)
UHP	252012	3.10±0.1	2.45±0.1	1.40±0.1	4.0±0.1	0.23±0.05

8-3. Packaging Quantity

Chip size	252012
Chip / Reel	2000

8-4. Tearing Off Force

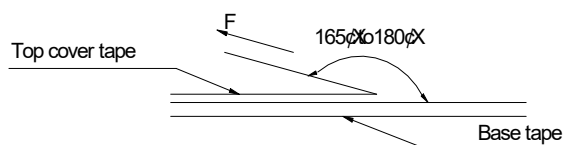

The force for tearing off cover tape is 10 to 100 grams in the arrow direction under the following conditions.

Room Temp. (°C)	Room Humidity (%)	Room atm (hPa)	Tearing Speed mm/min
5~35	45~85	860~1060	300

Application Notice

- Storage Conditions(component level)
To maintain the solderability of terminal electrodes:
 1. TAI-TECH products meet IPC/JEDEC J-STD-020D standard-MSL, level 1.
 2. Temperature and humidity conditions: Less than 40°C and 60% RH.
 3. Recommended products should be used within 12 months form the time of delivery.
 4. The packaging material should be kept where no chlorine or sulfur exists in the air.
- Transportation
 1. Products should be handled with care to avoid damage or contamination from perspiration and skin oils.
 2. The use of tweezers or vacuum pick up is strongly recommended for individual components.
 3. Bulk handling should ensure that abrasion and mechanical shock are minimized.

9. Typical Performance Curves

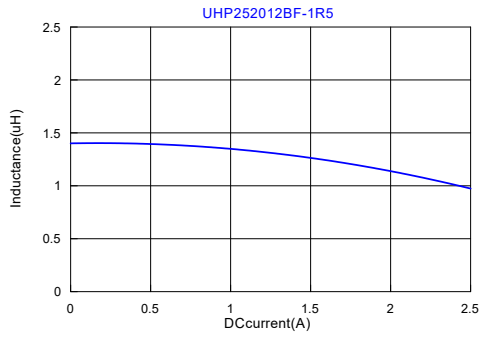

X-ON Electronics

Largest Supplier of Electrical and Electronic Components

Click to view similar products for [taitec](#) manufacturer:

Other Similar products are found below :

[TMPC1205HP-4R7MG-D](#) [TMPC0624H-4R7MG-D](#) [TMPC0402HP-R10YG-Z02](#) [TMPC0502HP-R68MG-D](#) [TMPC1004H-1R5MG-D](#)
[TMPC0518HP-R47MG-D](#) [HPC6045NF-1R0M](#) [TMPC1004H-470MG-D](#) [HPC5020CF-2R2Y](#) [TMPA0603S-330MN-D](#) [TMPC0618H-1R0MG-D](#)
[TMPC0603H-1R0MG-D](#) [TMPA0605S-4R7MN-D](#) [TPRHC1207F-470M](#) [WCM3216F2SV-102T02](#) [TMPF0603A-3R3MN-D](#) [TMPC1265HP-100MG-D](#)
[TMPC0502HP-6R8MG-D](#) [UHP252012NF-R47M](#) [AHP201610TF-R68M-1](#) [WCM2012F2SF-161T03](#) [HPC4018B-3R3M](#)
[HPC5020NF-1R0Y](#) [HPC5040NF-3R3M](#) [HPC8040NF-8R2M](#) [TMPC1205HP-330MG-D](#) [UHP252012NF-1R0MT01](#) [HPC5040NF-2R2M](#)
[HPC6045NF-100MTH](#) [HSF2012F2SF-670T04](#) [TMPC0412HP-R12MG-Z03](#) [TMPC1235HP-2R2MG-D](#) [TMPC1004H-1R0MG-D](#)
[TMPA1004S-1R0MN-D](#) [TMPC1265HP-2R2MG-D](#) [TMPC0615H-220MG-D](#) [DFP201610TF-R47M](#) [AHP201610AF-2R2M](#) [TMPC0512HP-4R7MG-D](#)
[TMPC0624H-R22MG-D](#) [TMPC1206HP-101MG-D](#) [TMPC1265HP-R82MG-D](#) [TMPA0603S-2R2MN-D](#) [WCM4532F2SF-601T15](#)
[FCM2012CF-600T07](#) [FCM2012CF-221T04](#) [FCI2012F-R39K](#) [HCB1608KF-471T20](#) [DFP252010TF-1R5M](#) [TMPC0602H-220MG-D](#)