

Ferrite Chip Bead for Power Lines

WCB4525KF-102T30

1.Features

1. Horizontal wound type.
2. Monolithic inorganic material construction.
3. Closed magnetic circuit avoids crosstalk.
4. Suitable for reflow soldering.
5. Shapes and dimensions follow E.I.A spec.
6. Available in various sizes.
7. Excellent solderability and heat resistance.
8. High reliability.
9. The products contain no lead and also support lead-free soldering.



Certificate of Green Partner

2. Dimensions

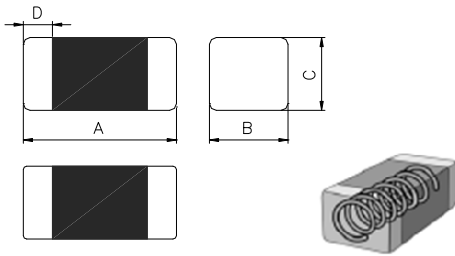

Chip Size				
Size	A(mm)	B(mm)	C(mm)	D(mm)
4525	4.5±0.4	2.5±0.3	2.5±0.3	0.9±0.6

3. Part Numbering

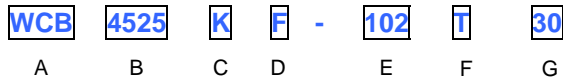

- A: Series
- B: Dimension L x W
- C: Material
- D: Lead Free Code
- E: Impedance 102=1000Ω
- F: Packaging T=Taping and Reel, B=Bulk(Bags)
- G: Rated Current 30=3000mA

4.Specification

Tai-Tech Part Number	Impedance (Ω)	Test Frequency (MHz)	DC Resistance (Ω) max.	Rated Current (mA) max.
WCB4525KF-102T30	1000±30%	100	0.06	3000

- Rated current: based on temperature rise test
- In compliance with EIA 595

■ Impedance-Frequency Characteristics

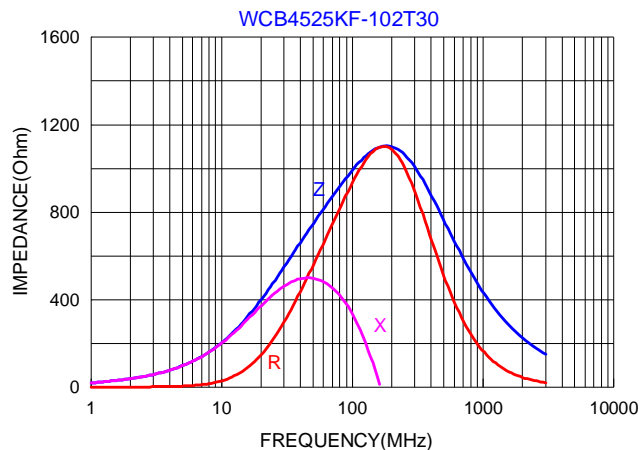

5. Reliability and Test Condition

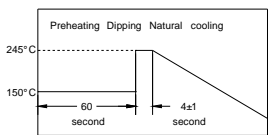
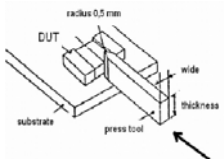
Item	Performance	Test Condition															
Series No.	WCB	--															
Operating Temperature	-40~+125°C (Including self-generated heat)	--															
Transportation Storage Temperature	-40~+85°C (on board)	For long storage conditions, please see the Application Notice															
Impedance (Z)	Within the specified tolerance	HP4291A or its equivalent															
Rated Current																	
DC Resistance		Milliohm High-Tester 3226 (Hioki Denki) or its equivalent.															
Resistance to Soldering Heat	Appearance : No damage. Impedance : within±15% of initial value Inductance : within±10% of initial value Q : Shall not exceed the specification value. RDC : within ±15% of initial value and shall not exceed the specification value	Number of heat cycles: 1 <table border="1"><thead><tr><th>Temperature (°C)</th><th>Time (s)</th><th>Temperature ramp/immersion and emersion rate</th></tr></thead><tbody><tr><td>260 ±5 (solder temp)</td><td>10 ±1</td><td>25mm/s ±6 mm/s</td></tr></tbody></table> Depth: completely cover the termination	Temperature (°C)	Time (s)	Temperature ramp/immersion and emersion rate	260 ±5 (solder temp)	10 ±1	25mm/s ±6 mm/s									
Temperature (°C)	Time (s)	Temperature ramp/immersion and emersion rate															
260 ±5 (solder temp)	10 ±1	25mm/s ±6 mm/s															
Solderability	More than 95% of the terminal electrode should be covered with solder. 	Preheat: 150°C, 60sec. Solder: Sn96.5%-Ag3%-Cu0.5% Solder temperature: 245±5°C Flux for lead free: Rosin. 9.5% Depth: completely cover the termination. Dip time: 4±1sec.															
Terminal strength	Appearance : No damage. Impedance : within±15% of initial value Inductance : within±10% of initial value Q : Shall not exceed the specification value. RDC : within ±15% of initial value and shall not exceed the specification value 	Preconditioning: Run through IR reflow for 2 times.(IPC/JEDEC J-STD-020D Classification Reflow Profiles) Component mounted on a PCB apply a force >=0805inch(2012mm):1kg <=0805inch(2012mm):0.5kg to the side of a device being tested. This force shall be applied for 60 +1 seconds. Also the force shall be applied gradually as not to shock the component being tested.															
Bending	Appearance : No damage. Impedance : within±10% of initial value Inductance : within±10% of initial value Q : Shall not exceed the specification value. RDC : within ±15% of initial value and shall not exceed the specification value	Shall be mounted on a FR4 substrate of the following dimensions: >=0805inch(2012mm):40x100x1.2mm <0805inch(2012mm):40x100x0.8mm Bending depth: >=0805inch(2012mm):1.2mm <0805inch(2012mm):0.8mm Duration of 10 sec for a min.															
Vibration Test	Appearance : No damage. Impedance : within±15% of initial value Inductance : within±10% of initial value Q : Shall not exceed the specification value. RDC : within ±15% of initial value and shall not exceed the specification value	Preconditioning: Run through IR reflow for 2 times.(IPC/JEDEC J-STD-020D Classification Reflow Profiles) Oscillation Frequency: 10 ~ 2K ~ 10Hz for 20 minutes Equipment : Vibration checker Total Amplitude:1.52mm±10% Testing Time : 12 hours(20 minutes, 12 cycles each of 3 orientations) ◦															
Shock	Appearance : No damage. Impedance : within±10% of initial value Inductance : within±10% of initial value Q : Shall not exceed the specification value. RDC : within ±15% of initial value and shall not exceed the specification value	Test condition: <table border="1"><thead><tr><th>Type</th><th>Peak Value (g's)</th><th>Normal duration (D) (ms)</th><th>Wave form</th><th>Velocity change (V)/ft/sec</th></tr></thead><tbody><tr><td>SMD</td><td>50</td><td>11</td><td>Half-sine</td><td>11.3</td></tr><tr><td>Lead</td><td>50</td><td>11</td><td>Half-sine</td><td>11.3</td></tr></tbody></table>	Type	Peak Value (g's)	Normal duration (D) (ms)	Wave form	Velocity change (V)/ft/sec	SMD	50	11	Half-sine	11.3	Lead	50	11	Half-sine	11.3
Type	Peak Value (g's)	Normal duration (D) (ms)	Wave form	Velocity change (V)/ft/sec													
SMD	50	11	Half-sine	11.3													
Lead	50	11	Half-sine	11.3													
Thermal shock	Appearance: no damage. Impedance: within±15%of initial value. Inductance: within±10%of initial value. Q : Shall not exceed the specification value. RDC : within ±15% of initial value and shall not exceed the specification value	Preconditioning: Run through IR reflow for 2 times.(IPC/JEDEC J-STD-020D Classification Reflow Profiles) Condition for 1 cycle Step1: -40±2°C 30±5 min. Step2: 25±2°C ≤0.5min Step3: +125±2°C 30±5min. (Bead) Number of cycles: 500 Measured at room temperature after placing for 24±2 hrs.															

Item	Performance	Test Condition
Life test	Appearance: no damage.	Preconditioning: Run through IR reflow for 2 times.(IPC/JEDEC J-STD-020D Classification Reflow Profiles) Temperature: 125±2℃ (bead) Applied current: rated current. Duration: 1000±12hrs. Measured at room temperature after placing for 24±2 hrs.
Load Humidity	Impedance: within±15%of initial value. Inductance: within±10%of initial value. Q : Shall not exceed the specification value. RDC : within ±15% of initial value and shall not exceed the specification value	Preconditioning: Run through IR reflow for 2 times.(IPC/JEDEC J-STD-020D Classification Reflow Profiles) Humidity: 85±2%R.H. Temperature: 85±2℃. Duration: 1000hrs Min. with 100% rated current. Measured at room temperature after placing for 24±2 hrs.
Moisture Resitance	Appearance: no damage. Impedance: within±15%of initial value. Inductance: within±10%of initial value. Q : Shall not exceed the specification value. RDC : within ±15% of initial value and shall not exceed the specification value	Preconditioning: Run through IR reflow for 2 times.(IPC/JEDEC J-STD-020D Classification Reflow Profiles 1. Baked at 50℃ for 25hrs, measured at room temperature after placing for 4 hrs. 2. Raise temperature to 65±2℃ 90-100%RH in 2.5hrs, and keep 3 hours, cool down to 25℃ in 2.5hrs. 3. Raise temperature to 65±2℃ 90-100%RH in 2.5hrs, and keep 3 hours, cool down to 25℃ in 2.5hrs,keep at 25℃ for 2 hrs then keep at -10℃ for 3 hrs 4. Keep at 25℃ 80-100%RH for 15min and vibrate at the frequency of 10 to 55 Hz to 10 Hz, measure at room temperature after placing for 1~2 hrs.

6.Soldering and Mounting

6-1. Recommended PC Board Pattern

Type	Chip Size				Land Patterns For Reflow Soldering		
	A(mm)	B(mm)	C(mm)	D(mm)	E(mm)	F(mm)	G(mm)
2016	2.0±0.2	1.6±0.2	1.6±0.2	0.5+0.3	1.4	1.2	2.0
3216	3.2±0.3	1.6±0.2	1.6±0.2	0.5±0.3	1.4	2.2	2.0
3225	3.2±0.3	2.5±0.3	2.5±0.3	0.5±0.3	1.4	2.2	2.9
4516	4.5±0.3	1.6±0.2	1.6±0.2	0.5±0.3	1.75	3.5	2.0
4525	4.5±0.4	2.5±0.3	2.5±0.3	0.9±0.6	1.75	3.5	2.9
4532	4.5±0.4	3.2±0.3	3.2±0.3	0.9±0.6	1.75	3.5	3.7

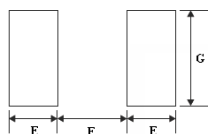

PC board should be designed so that products can prevent damage from mechanical stress when warping the board.

6-2. Soldering

Mildly activated rosin fluxes are preferred. The terminations are suitable for re-flow soldering systems. If hand soldering cannot be avoided, the preferred technique is the utilization of hot air soldering tools.

Note.

If wave soldering is used ,there will be some risk.

Re-flow soldering temperatures below 240 degrees, there will be non-wetting risk

6-2.1 Lead Free Solder re-flow:

Recommended temperature profiles for lead free re-flow soldering in Figure 1. (Referred to J-STD-020C)

6-2.2 Soldering Iron:

Products attachment with a soldering iron is discouraged due to the inherent process control limitations. If a soldering iron must be employed the following precautions are recommended. for Iron Soldering in Figure 2.

- Preheat circuit and products to 150°C
- Never contact the ceramic with the iron tip
- Use a 20 watt soldering iron with tip diameter of 1.0mm
- 350°C tip temperature (max)
- 1.0mm tip diameter (max)
- Limit soldering time to 4-5sec.

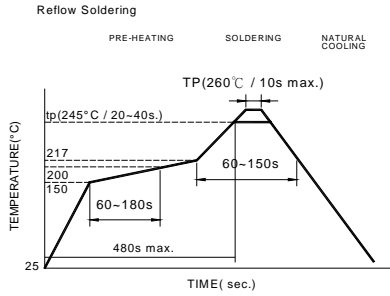

Reflow times: 3 times max
Fig.1

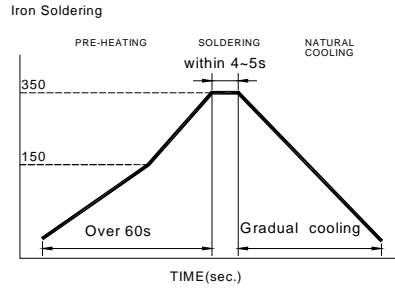

Iron Soldering times : 1 times max
Fig.2

6-2.3 Solder Volume:

Accordingly increasing the solder volume, the mechanical stress to product is also increased. Exceeding solder volume may cause the failure of mechanical or electrical performance. Solder shall be used not to be exceed as shown in right side:

Minimum fillet height = soldering thickness + 25% product height

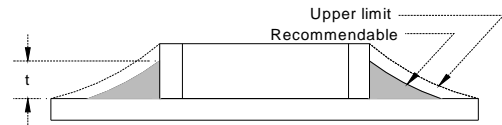

7.Packaging Information

7-1. Reel Dimension

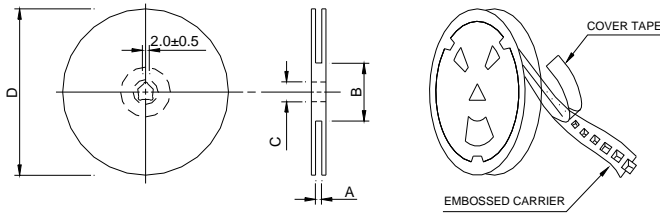

Type	A(mm)	B(mm)	C(mm)	D(mm)
2016	10.0±1.5	60+1/-0	13±0.5	180+0/-3
3216				
3225				
4516	14.0±1.5	60+1/-0	13±0.5	180+0/-3
4525				
4532	14.0±2.0	100±1.0	13±0.5	330±2.0

7-2.1 Tape Dimension / 8mm

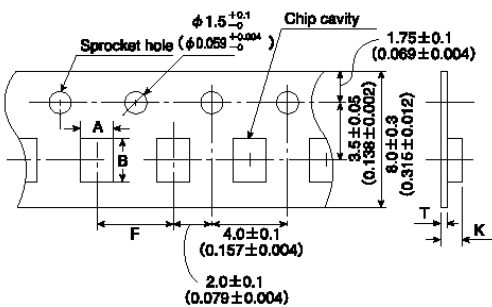

Size	A(mm)	B(mm)	K(mm)	F(mm)	T(mm)
2016	1.8±0.2	2.2±0.2	2.6 max.	4.0±0.2	0.6 max.
3216	1.9±0.2	3.5±0.2	2.6 max.	4.0±0.2	0.6 max.
3225	2.8±0.2	3.5±0.2	4.0 max.	4.0±0.2	0.6 max.

7-2.2 Tape Dimension / 12mm

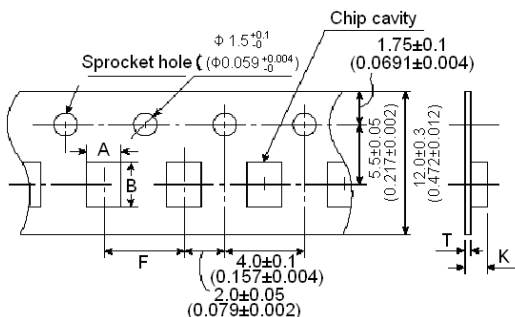

Size	A(mm)	B(mm)	K(mm)	F(mm)	T(mm)
4516	1.9±0.2	4.9±0.2	2.6 max.	4.0±0.2	0.6 max.
4525	2.9±0.2	4.9±0.2	4.0 max.	4.0±0.2	0.6 max.
4532	3.6±0.2	4.9±0.2	4.0 max.	8.0±0.2	0.6 max.

7-3. Packaging Quantity

Chip Size	2016	3216	3225	4516	4525	4532
Chip / Reel	2000	2000	1000	2000	1000	2000

Units: pcs

7-4. Top Tape Strength

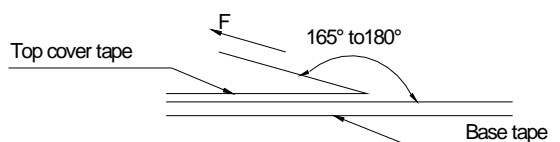

The force for tearing off cover tape is 15 to 60 grams in the arrow direction under the following conditions.

Room Temp. (°C)	Room Humidity (%)	Room atm (hPa)	Tearing Speed mm/min
5-35	45-85	860-1060	300

Application Notice

- Storage Conditions(component level)
To maintain the solder ability of terminal electrodes:
 1. TAI-TECH products meet IPC/JEDEC J-STD-020D standard-MSL, level 1.
 2. Temperature and humidity conditions: Less than 40°C and 60% RH.
 3. Recommended products should be used within 12 months from the time of delivery.
 4. The packaging material should be kept where no chlorine or sulfur exists in the air.
- Transportation
 1. Products should be handled with care to avoid damage or contamination from perspiration and skin oils.
 2. The use of tweezers or vacuum pick up is strongly recommended for individual components.
 3. Bulk handling should ensure that abrasion and mechanical shock are minimized.

X-ON Electronics

Largest Supplier of Electrical and Electronic Components

Click to view similar products for [taitec](#) manufacturer:

Other Similar products are found below :

[TMPC1205HP-4R7MG-D](#) [TMPC0624H-4R7MG-D](#) [TMPC0402HP-R10YG-Z02](#) [TMPC0502HP-R68MG-D](#) [TMPC1004H-1R5MG-D](#)
[TMPC0518HP-R47MG-D](#) [HPC6045NF-1R0M](#) [TMPC1004H-470MG-D](#) [HPC5020CF-2R2Y](#) [TMPA0603S-330MN-D](#) [TMPC0618H-1R0MG-D](#)
[TMPA0605S-4R7MN-D](#) [TPRHC1207F-470M](#) [WCM3216F2SV-102T02](#) [TMPF0603A-3R3MN-D](#) [TMPC1265HP-100MG-D](#)
[TMPC0603H-1R0MG-D](#) [TMPC0502HP-6R8MG-D](#) [UHP252012NF-R47M](#) [AHP201610TF-R68M-1](#) [WCM2012F2SF-161T03](#) [HPC4018B-3R3M](#)
[HPC5020NF-1R0Y](#) [HPC5040NF-3R3M](#) [HPC8040NF-8R2M](#) [TMPC1205HP-330MG-D](#) [UHP252012NF-1R0MT01](#) [HPC5040NF-2R2M](#)
[HPC6045NF-100MTH](#) [HSF2012F2SF-670T04](#) [TMPC0412HP-R12MG-Z03](#) [TMPC1235HP-2R2MG-D](#) [TMPC1004H-1R0MG-D](#)
[TMPA1004S-1R0MN-D](#) [TMPC1265HP-2R2MG-D](#) [TMPC0615H-220MG-D](#) [DFP201610TF-R47M](#) [AHP201610AF-2R2M](#) [TMPC0512HP-4R7MG-D](#)
[TMPC0624H-R22MG-D](#) [TMPC1206HP-101MG-D](#) [TMPC1265HP-R82MG-D](#) [TMPA0603S-2R2MN-D](#) [WCM4532F2SF-601T15](#)
[FCM2012CF-600T07](#) [FCM2012CF-221T04](#) [FCI2012F-R39K](#) [HCB1608KF-471T20](#) [DFP252010TF-1R5M](#) [TMPC0602H-220MG-D](#)