

Wire Wound Type Common Mode Filter

ACM4532F2NV-SERIES-D

1. Features

1. High common mode impedance at high frequency effects excellent noise suppression performance.
2. ACM4532F2NV series realizes small size and low profile. 4.5x3.2x2.8 mm.
3. 100% Lead(Pb) & Halogen-Free and RoHS compliant.
4. High reliability -Reliability tests comply with AEC-Q200
5. Operating temperature -55~+150°C (Including self - temperature rise)



2. Dimension

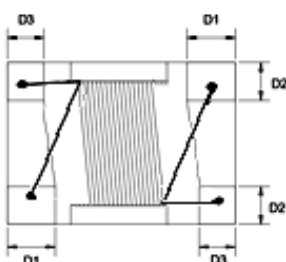
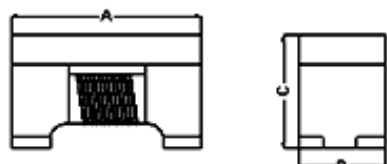

Recommended PC Board Pattern

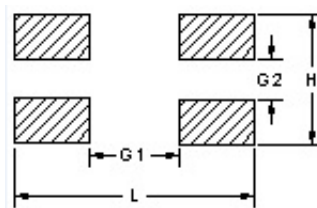

Series	A(mm)	B(mm)	C(mm)	D1(mm)	D2(mm)	D3(mm)	L(mm)	H(mm)	G1(mm)	G2(mm)
4532F2NV	4.5±0.2	3.2±0.2	2.8±0.2	0.75±0.2	0.85±0.2	0.60±0.2	5.0	3.6	3.4	1.7

3. Part Numbering

ACM
4532
F
2
N
V
-
101
T
02
-
D

A B C D E F G H I J

- A: Series
 B: Dimension
 C: Material Ferrite Core
 D: Number of Lines 2=2 lines
 E: Type N45
 F: Category Code V=Vehicle
 G: Inductance 101=100uH
 H: Packaging T=Taping and Reel
 I: Rated Current 02=200mA
 J: Control S/N

4. Specification

TAI-TECH Part Number	Common mode Impedance (Ω) [10MHz]		Inductance (μH)+50/-30% [100kHz/0.1V]	DC Resistance (Ω) max.	Rated Current (mA)	Rated Volt. (Vdc)	IR (MΩ) min.
ACM4532F2NV-110T03-D	300 min.	600 typ.	11	0.6	360	50	10
ACM4532F2NV-220T03-D	500 min.	1200 typ.	22	1.0	310	50	10
ACM4532F2NV-510T02-D	1000 min.	2800 typ.	51	1.0	230	50	10
ACM4532F2NV-101T02-D	2000 min.	5800 typ.	100	2.0	200	50	10

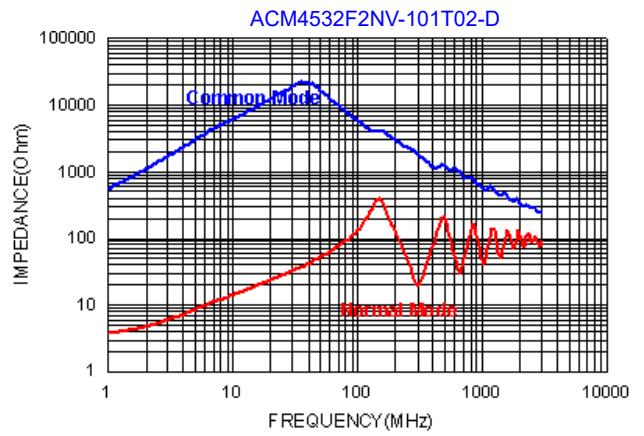
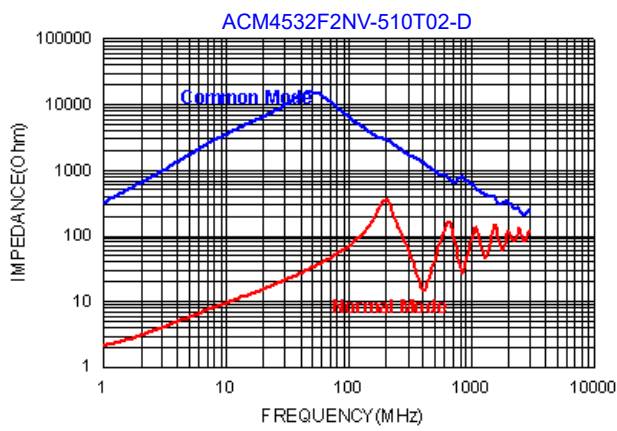
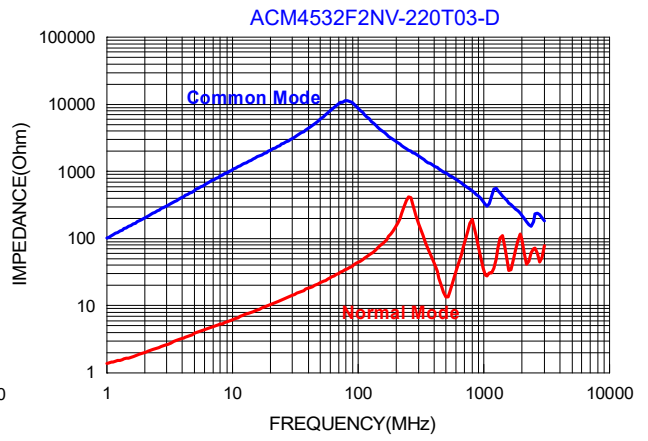
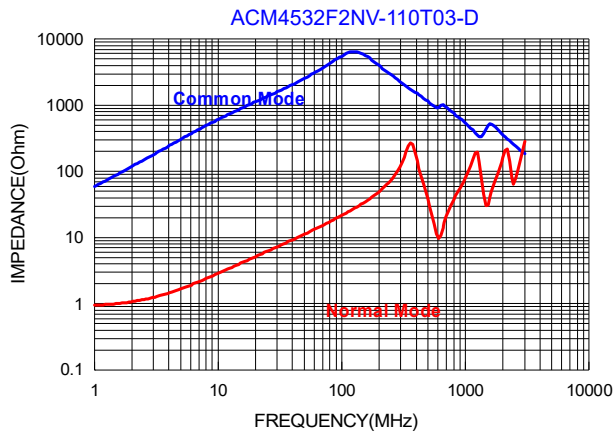

5. Schematic Diagram

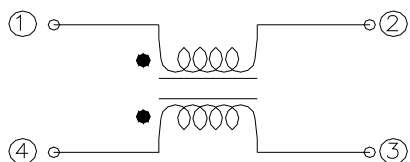

6. MEASURING CIRCUITS 2LINE

Common mode

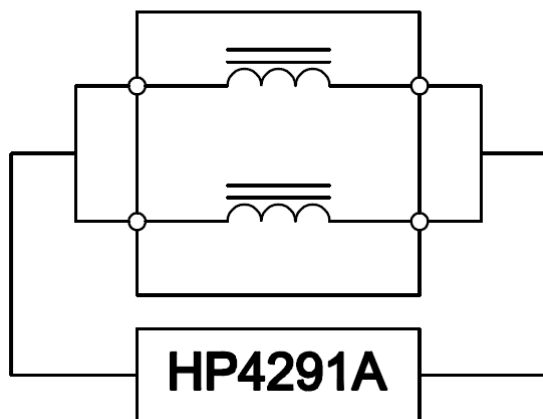

Differential mode

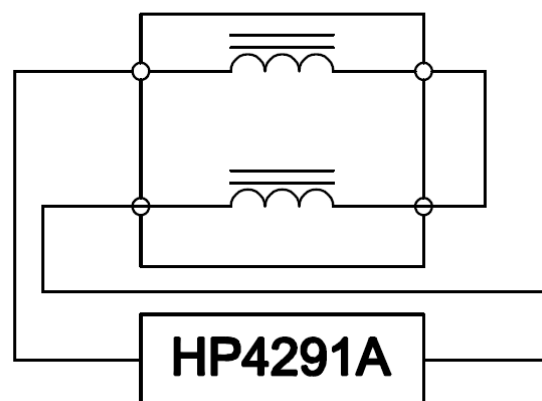

7. Materials

No.	Description	Specification
a.	Upper Plate	Ferrite
b.	Core	Ferrite Core
c.	Termination	Ag/Ni/Sn
d.	Wire	Enameled Copper Wire

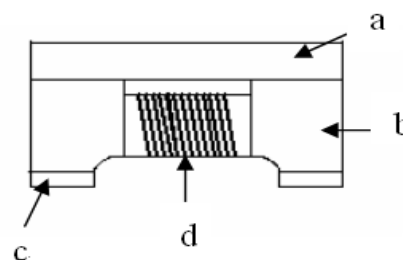

8. Reliability and Test Condition

Item	Performance	Test Condition															
Operating temperature	-55~+150°C (Including self - temperature rise)																
Storage temperature	-55~+125°C (on board)																
Electrical Performance Test																	
L(common mode)	Refer to standard electrical characteristics list.	Agilent-4285A+ Agilent -16334A															
DCR		Agilent-4338B															
I.R.		Agilent4339															
Temperature Rise Test	Rated Current ΔT 40°C Max	1. Applied the allowed DC current. 2. Temperature measured by digital surface thermometer															
Reliability Test																	
High Temperature Exposure(Storage) AEC-Q200	Appearance : No damage. Impedance : within±15% of initial value Inductance : within±10% of initial value RDC : within ±15% of initial value and shall not exceed the specification value	Preconditioning: Run through IR reflow for 2 times.(IPC/JEDEC J-STD-020DCclassification Reflow Profiles Temperature : 150±2°C Duration : 1000hrs Min. Measured at room temperature after placing for 24±2 hrs															
Temperature Cycling AEC-Q200		Preconditioning: Run through IR reflow for 2 times.(IPC/JEDEC J-STD-020DCclassification Reflow Profiles Condition for 1 cycle Step1 : -55±2°C 30min Min. Step2 : 150±2°C transition time 1min MAX. Step3 : 150±2°C 30min Min. Step4 : Low temp. transition time 1min MAX. Number of cycles : 1000 Measured at room temperature after placing for 24±2 hrs															
Biased Humidity (AEC-Q200)		Preconditioning: Run through IR reflow for 2 times.(IPC/JEDEC J-STD-020DCclassification Reflow Profiles Humidity : 85±3%RH, Temperature : 85°C±2°C Duration : 1000hrs Min Measured at room temperature after placing for24±2hrs															
High Temperature Operational Life (AEC-Q200)		Preconditioning: Run through IR reflow for 2 times.(IPC/JEDEC J-STD-020DCclassification Reflow Profiles Temperature : 150±2°C Duration : 1000hrs Min. with 100% rated current. Measured at room temperature after placing for24±2hrs															
External Visual		Appearance : No damage.	Inspect device construction, marking and workmanship. Electrical Test not required.														
Physical Dimension	According to the product specification size measurement	According to the product specification size measurement															
Resistance to Solvents	Appearance : No damage.	Add aqueous wash chemical - OKEM clean or equivalent.															
Mechanical Shock	Appearance : No damage. Impedance : within±15% of initial value Inductance : within±10% of initial value RDC : within ±15% of initial value and shall not exceed the specification value	<table border="1"> <thead> <tr> <th>Type</th> <th>Peak value (g's)</th> <th>Normal duration (D) (ms)</th> <th>Wave form</th> <th>Velocity change (Vi)ft/sec</th> </tr> </thead> <tbody> <tr> <td>SMD</td> <td>100</td> <td>6</td> <td>Half-sine</td> <td>12.3</td> </tr> <tr> <td>Lead</td> <td>100</td> <td>6</td> <td>Half-sine</td> <td>12.3</td> </tr> </tbody> </table> <p>shocks in each direction along 3 perpendicular axes.</p>	Type	Peak value (g's)	Normal duration (D) (ms)	Wave form	Velocity change (Vi)ft/sec	SMD	100	6	Half-sine	12.3	Lead	100	6	Half-sine	12.3
Type	Peak value (g's)	Normal duration (D) (ms)	Wave form	Velocity change (Vi)ft/sec													
SMD	100	6	Half-sine	12.3													
Lead	100	6	Half-sine	12.3													

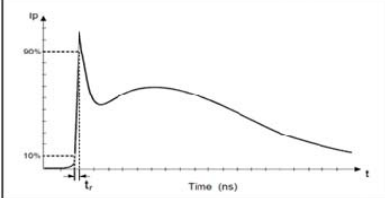
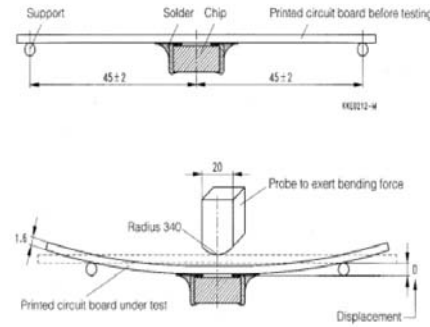
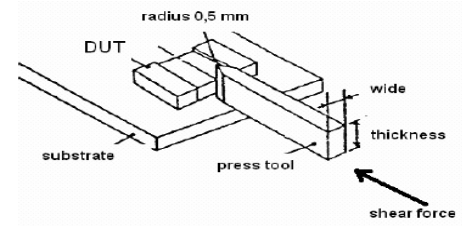
Item	Performance	Test Condition								
Vibration		PC/JEDEC J-STD-020D Classification Reflow Profiles Oscillation Frequency: 10Hz~2KHz~10Hz for 20 minute Equipment : Vibration checker Total Amplitude: 5g Testing Time : 12 hours (20 minutes, 12 cycles each of 3 orientations)								
Resistance to Soldering Heat	Appearance : No damage. Impedance : within $\pm 15\%$ of initial value Inductance : within $\pm 10\%$ of initial value RDC : within $\pm 15\%$ of initial value and shall not exceed the specification value	Test condition : <table border="1" data-bbox="965 414 1444 533"> <thead> <tr> <th>Temperature(°C)</th> <th>Time(s)</th> <th>Temperature ramp/immersion and emersion rate</th> <th>Number of heat cycles</th> </tr> </thead> <tbody> <tr> <td>250\pm5(soldertemp)</td> <td>30\pm5</td> <td>1°C/s-4°C/s; time above 183°C, 90s-120s</td> <td>3</td> </tr> </tbody> </table>	Temperature(°C)	Time(s)	Temperature ramp/immersion and emersion rate	Number of heat cycles	250 \pm 5(soldertemp)	30 \pm 5	1°C/s-4°C/s; time above 183°C, 90s-120s	3
Temperature(°C)	Time(s)	Temperature ramp/immersion and emersion rate	Number of heat cycles							
250 \pm 5(soldertemp)	30 \pm 5	1°C/s-4°C/s; time above 183°C, 90s-120s	3							
Thermal shock (AEC-Q200)		Preconditioning: Run through IR reflow for 2 times.(IPC/JEDEC J-STD-020D Classification Reflow Profiles Condition for 1 cycle Step1 : -55 \pm 2°C 15 \pm 1min Step2 : 150 \pm 2°C within 20Sec. Step3 : 150 \pm 2°C 15 \pm 1min Number of cycles : 300 Measured at room femperaturc after placing fo24 \pm 2hrs								
ESD	Appearance : No damage.									
Solderability	More than 95% of the terminal electrode should be covered with solder	a. Method B, 4 hrs @155°C dry heat @235°C \pm 5°C Testing Time :5 +0/-0.5 seconds b. Method D category 3. (8hours \pm 15 min)@ 260°C \pm 5°C Testing Time :30 +0/-0.5 seconds								
Electrical Characterization	Refer Specification for Approval	Summary to show Min, Max, Mean and Standard deviation .								
Flammability	Electrical Test not required.	V-0 or V-1 are acceptable.								
Board Flex	Appearance : No damage	Preconditioning: Run through IR reflow for 2 times.(IPC/JEDEC J-STD-020D Classification Reflow Profiles Place the 100mm X 40mm board into a fixture similar to the one shown in below Figure with the component facing down. The apparatus shall consist of mechanical means to apply a force which will bend the board (D) x = 2 mm minimum. The duration of the applied forces shall be 60 (+ 5) sec. The force is to be applied only once to the board. 								
Terminal Strength(SMD)	Appearance : No damage	Preconditioning: Run through IR reflow for 2 times.(IPC/JEDEC J-STD-020D Classification Reflow Profiles With the component mounted on a PCB with the device to be tested, apply a 17.7 N (1.8 Kg) force to the side of a device being tested. This force shall be applied for 60 +1 seconds. Also the force shall be applied gradually as not to apply a shock to the component being tested. 								

9. Soldering and Mounting

9-1. Soldering

Mildly activated rosin fluxes are preferred. TAI-TECH terminations are suitable for all wave and re-flow soldering systems. If hand soldering cannot be avoided, the preferred technique is the utilization of hot air soldering tools.

9-1.1 Solder re-flow:

Recommended temperature profiles for re-flow soldering in Figure 1.

9-1.2 Soldering Iron(Figure 2):

Products attachment with a soldering iron is discouraged due to the inherent process control limitations. In the event that a soldering iron must be employed the following precautions are recommended.

- Preheat circuit and products to 150°C
- Never contact the ceramic with the iron tip
- Use a 20 watt soldering iron with tip diameter of 1.0mm
- 350°C tip temperature (max)
- 1.0mm tip diameter (max)
- Limit soldering time to 4~5 sec.

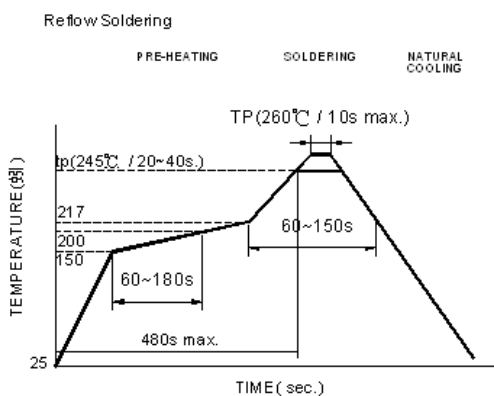

Reflow times: 3 times max.

Fig.1

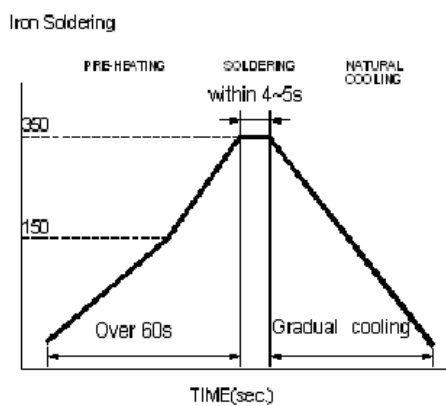

Iron Soldering times: 1 times max.

Fig.2

10. Packaging Information

10-1. Reel Dimension

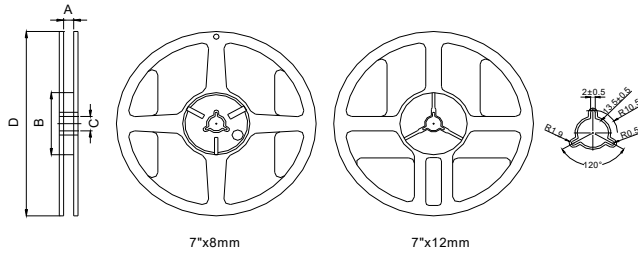

Type	A(mm)	B(mm)	C(mm)	D(mm)
7"x12mm	13.5±0.5	60±2	13.5±0.5	178±2

10-2. Tape Dimension / 12mm

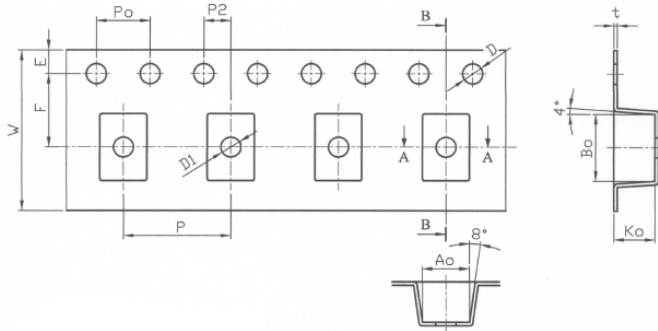

Series	P(mm)	Po(mm)	P2(mm)	Bo(mm)	Ao(mm)	Ko(mm)	D(mm)	E(mm)	F(mm)	W(mm)	t(mm)	D1(mm)
ACM4532F2N	8.00±0.10	4.00±0.10	2.00±0.05	4.90±0.10	3.60±0.10	3.00±0.10	1.50+0.10/-0.00	1.75±0.10	5.50±0.05	12.00±0.10	0.26±0.05	1.50±0.10

10-3. Packaging Quantity

Chip size	Chip/Reel	Inner Box	Middle Box	Carton
ACM4532F2N	500	2000	10000	20000

10-4. Tearing Off Force

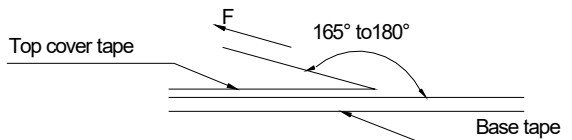

The force for tearing off cover tape is 15 to 80 grams in the arrow direction under the following conditions.

Room Temp. (°C)	Room Humidity (%)	Room atm (hPa)	Tearing Speed mm/min
5~35	45~85	860~1060	300

Application Notice

• Storage Conditions(component level)

To maintain the solderability of terminal electrodes:

1. TAI-TECH products meet IPC/JEDEC J-STD-020D standard-MSL, level 1.
2. Temperature and humidity conditions: Less than 40°C and 60% RH.
3. Recommended products should be used within 12 months form the time of delivery.
4. The packaging material should be kept where no chlorine or sulfur exists in the air.

• Transportation

1. Products should be handled with care to avoid damage or contamination from perspiration and skin oils.
2. The use of tweezers or vacuum pick up is strongly recommended for individual components.
3. Bulk handling should ensure that abrasion and mechanical shock are minimized.

X-ON Electronics

Largest Supplier of Electrical and Electronic Components

Click to view similar products for [Common Mode Chokes / Filters](#) category:

Click to view products by [Tai-Tech](#) manufacturer:

Other Similar products are found below :

[PE-64683](#) [ST6118T-R](#) [FE3X025-10-7NL](#) [T8114NLT](#) [TCM0806G-350-2P-T](#) [TCM0806G-650-2P-T](#) [IND-0110](#) [UAL21VR0802000](#)
[UALSC023000000](#) [UALSC1020JH000](#) [UALSU10VD20010](#) [UALSU9VD070100](#) [36-00037](#) [CM7060M132R-10](#) [UALW21HS072450](#)
[UALSU9H0208000](#) [UAL24VK06450CH](#) [PLT10HH501100PNB](#) [PLT10HH401100PNB](#) [PLT10HH1026R0PNB](#) [36-00029-01](#) [PE-67531](#)
[TLH10UB](#) [113 0R5](#) [2752045447](#) [CM8663Z161B-10](#) [7351V](#) [CMF16-153131](#) [T8116NLT](#) [CMS2-10-R](#) [FE2X10-4-2NL](#) [T8003NLT](#) [CTX01-](#)
[13663](#) [CTX66-19521-R](#) [RC212-0.5-10M](#) [RC112-0.4-15M](#) [RC212-0.6-6M8](#) [RC212-0.4-15M](#) [RC112-0.3-30M](#) [4534-3](#)
[WTCF2012Z0M751PB](#) [PH9408.814NLT](#) [B82498B3221J000](#) [PAC6006.364NLT](#) [PAC6006.444NLT](#) [PAC6006.204NLT](#) [PH9407.204NLT](#)
[PAC6006.264NLT](#) [PH9408.105NLT](#) [PH9408.494NLT](#) [PAC6006.104NLT](#)