

# Specification for Approval

Date: 2021/08/16

**Customer :** 天诚科技

**TAI-TECH P/N:** DFP252012TF-R33M

**CUSTOMER P/N:**

**DESCRIPTION:**

**QUANTITY:**

<b>REMARK:</b>	
Customer Approval Feedback	

西北臺慶科技股份有限公司  
**TAI-TECH Advanced Electronics Co., Ltd**

代理商:

- 深圳市天诚科技有限公司  
 Shenzhen TsaSun Technology Co., Ltd.  
 Room 209, 2/F, Block A, Tengfei Industrial Building, No.6,  
 Taohua Road, Futian District, Shenzhen  
 TEL: 0755-8335 8885 / 0755-8335 9885  
 E-mail: sales@tsasun.com  
 www.tsacoil.com

- 西北臺慶科技股份有限公司  
 TAI-TECH Advanced Electronics Co., Ltd  
**Headquarter:**  
 NO.1 YOU 4TH ROAD, YOUTH INDUSTRIAL DISTRICT, YANG-MEI,  
 TAO-YUAN HSIEN, TAIWAN, R.O.C.  
 TEL: +886-3-4641148 FAX: +886-3-4643565  
 http://www.tai-tech.com.tw  
 E-mail: sales@tai-tech.com.tw

- 臺慶精密電子(昆山)有限公司  
 TAI-TECH ADVANCED ELECTRONICS(KUNSHAN) CO., LTD  
 SHINWHA ROAD, KUNJIA HI-TECH INDUSTRIAL PARK, KUN-SHAN,  
 JIANG-SU, CHINA  
 TEL: +86-512-57619396 FAX: +86-512-57619688  
 E-mail: hui@tai-tech.com.tw

Sales Dep.

APPROVED	CHECKED
夏曉曼	夏曉曼

R&D Center

APPROVED	CHECKED	DRAWN
羅宜春	梁周虎	卜文娟

# Power Inductor

DFP252012TF-R33M

## 1. Features

1. This specification applies Low Profile Power Inductors.
2. 100% Lead(Pb) & Halogen-Free and RoHS compliant.



## 2. Dimension

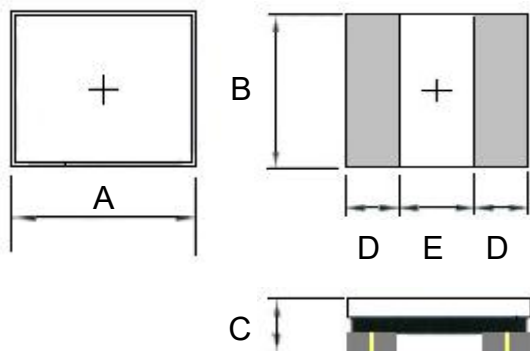

Series	A(mm)	B(mm)	C(mm)	D(mm)	E(mm)
DFP252012TF	2.5 -0.1/+0.2	2.0 -0.05/+0.35	1.2Max	0.85 ref.	0.80 ref.

Units: mm

## 3. Part Numbering

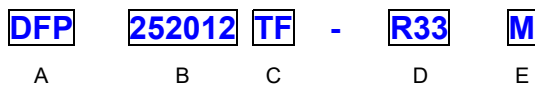

A: Series

B: Dimension

C: Lead Free

Material

D: Inductance

R33=0.33uH

E: Inductance Tolerance

M=±20%

## 4. Specification

TAI-TECH Part Number	Inductance (uH)	Tolerance (%)	Test Frequency (Hz)	DCR (Ω) typ.	DCR (Ω) Max.	I sat (A) typ.	I sat (A) Max.	I rms (A) typ	I rms (A)Max.
DFP252012TF-R33M	0.33	±20%	0.1V/1M	0.027	0.032	5.70	4.60	4.50	4.00

Note:

Isat: Saturation Current (Isat) will cause L0 to drop approximately 30%.

Irms: Heat Rated Current (Irms) will cause the coil temperature rise approximately ΔT of 40°C

## 5. Material List

No.	Description	Specification
a.	Core	Ferrite Core
b.	Wire	Enameled Copper Wire
c.	Glue	Epoxy with magnetic powder
d.	Terminal	Ag/Ni/Sn

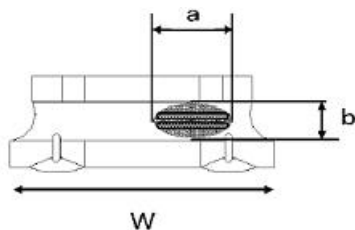
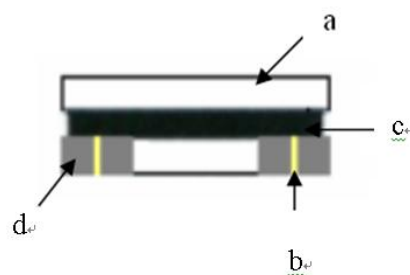

Appearance of exposed wire tolerance limit:

1. Width direction (dimension a): Acceptable when  $a \leq w/2$   
Nonconforming when  $a > w/2$
2. Length direction (dimension b): Dimension b is not specified.
3. The total area of exposed wire occurring to each sides is not greater than 50% of coating resin area, and is acceptable.

## 6. Reliability and Test Condition

Item	Performance	Test Condition
Operating temperature	-40~+125℃ (Including self - temperature rise)	
Storage temperature	1. -10~+40℃,50~60%RH (Product with taping) 2. -40~+125℃ (on board)	
<b>Electrical Performance Test</b>		
Inductance	Refer to standard electrical characteristics list.	HP4284A,CH11025,CH3302,CH1320,CH1320S LCR Meter.
DCR		CH16502,Agilent33420A Micro-Ohm Meter.
Saturation Current (Isat)	Approximately $\Delta$ L30% .	Saturation DC Current (Isat) will cause L0 to drop $\Delta$ L(%)(keep quickly).
Heat Rated Current (Irms)	Approximately $\Delta$ T40℃	Heat Rated Current (Irms) will cause the coil temperature rise $\Delta$ T(℃) without core loss. 1.Applied the allowed DC current(keep 1 min.). 2.Temperature measured by digital surface thermometer
<b>Reliability Test</b>		
Life Test	Appearance: No damage. Inductance: within $\pm$ 10% of initial value Q: Shall not exceed the specification value. RDC: within $\pm$ 15% of initial value and shall not exceed the specification value	Preconditioning: Run through IR reflow for 2 times.( IPC/JEDEC J-STD-020DClassification Reflow Profiles) Temperature: 125 $\pm$ 2℃ Applied current: rated current Duration: 1000 $\pm$ 12hrs Measured at room temperature after placing for 24 $\pm$ 2 hrs
Load Humidity		Preconditioning: Run through IR reflow for 2 times.( IPC/JEDEC J-STD-020DClassification Reflow Profiles) Humidity: 85 $\pm$ 2% R.H, Temperature: 85℃ $\pm$ 2℃ Duration: 1000hrs Min. with 100% rated current Measured at room temperature after placing for 24 $\pm$ 2 hrs
Moisture Resistance		Preconditioning: Run through IR reflow for 2 times.( IPC/JEDEC J-STD-020DClassification Reflow Profiles 1. Baked at50℃ for 25hrs, measured at room temperature after placing for 4 hrs. 2. Raise temperature to 65 $\pm$ 2℃ 90-100%RH in 2.5hrs, and keep 3 hours, cool down to 25℃ in 2.5hrs. 3. Raise temperature to 65 $\pm$ 2℃ 90-100%RH in 2.5hrs, and keep 3 hours, cool down to 25℃ in 2.5hrs,keep at 25℃ for 2 hrs then keep at -10℃ for 3 hrs 4. Keep at 25℃ 80-100%RH for 15min and vibrate at the frequency of 10 to 55 Hz to 10 Hz, measure at room temperature after placing for 1~2 hrs.
Thermal shock		Preconditioning: Run through IR reflow for 2 times.( IPC/JEDEC J-STD-020DClassification Reflow Profiles Condition for 1 cycle Step1: -40 $\pm$ 2℃ 30 $\pm$ 5min Step2: 25 $\pm$ 2℃ $\leq$ 0.5min Step3: 125 $\pm$ 2℃ 30 $\pm$ 5min Number of cycles: 500 Measured at room temperature after placing for 24 $\pm$ 2 hrs
Vibration		Oscillation Frequency: 10~2K~10Hz for 20 minutes Equipment: Vibration checker Total Amplitude:1.52mm $\pm$ 10% Testing Time : 12 hours(20 minutes, 12 cycles each of 3 orientations).

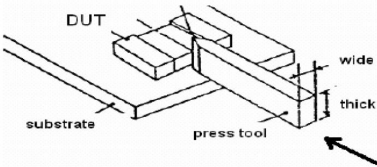
Item	Performance	Test Condition															
Bending	Appearance: No damage.	Shall be mounted on a FR4 substrate of the following dimensions: >=0805 inch(2012mm):40x100x1.2mm <0805 inch(2012mm):40x100x0.8mm Bending depth: >=0805 inch(2012mm):1.2mm <0805 inch(2012mm):0.8mm duration of 10 sec.															
Shock	Impedance: within±15% of initial value Inductance: within±10% of initial value Q: Shall not exceed the specification value. RDC: within ±15% of initial value and shall not exceed the specification value	<table border="1"> <thead> <tr> <th>Type</th> <th>Peak value (g's)</th> <th>Normal duration (D) (ms)</th> <th>Wave form</th> <th>Velocity change (V)ft/sec</th> </tr> </thead> <tbody> <tr> <td>SMD</td> <td>50</td> <td>11</td> <td>Half-sine</td> <td>11.3</td> </tr> <tr> <td>Lead</td> <td>50</td> <td>11</td> <td>Half-sine</td> <td>11.3</td> </tr> </tbody> </table>	Type	Peak value (g's)	Normal duration (D) (ms)	Wave form	Velocity change (V)ft/sec	SMD	50	11	Half-sine	11.3	Lead	50	11	Half-sine	11.3
Type	Peak value (g's)	Normal duration (D) (ms)	Wave form	Velocity change (V)ft/sec													
SMD	50	11	Half-sine	11.3													
Lead	50	11	Half-sine	11.3													
Solder ability	More than 95% of the terminal electrode should be covered with solder.	Preheat: 150°C,60sec. Solder: Sn96.5% Ag3% Cu0.5% Temperature: 245±5°C. Flux for lead free: Rosin. 9.5%. Dip time: 4±1sec. Depth: completely cover the termination															
Resistance to Soldering Heat		Depth: completely cover the termination <table border="1"> <thead> <tr> <th>Temperature(°C)</th> <th>Time(s)</th> <th>Temperature ramp/immersion and emersion rate</th> <th>Number of heat cycles</th> </tr> </thead> <tbody> <tr> <td>260 ±5 (solder temp)</td> <td>10 ±1</td> <td>25mm/s ±6 mm/s</td> <td>1</td> </tr> </tbody> </table>	Temperature(°C)	Time(s)	Temperature ramp/immersion and emersion rate	Number of heat cycles	260 ±5 (solder temp)	10 ±1	25mm/s ±6 mm/s	1							
Temperature(°C)	Time(s)	Temperature ramp/immersion and emersion rate	Number of heat cycles														
260 ±5 (solder temp)	10 ±1	25mm/s ±6 mm/s	1														
Terminal Strength	Appearance: No damage. Impedance: within±15% of initial value Inductance: within±10% of initial value Q: Shall not exceed the specification value. RDC: within ±15% of initial value and shall not exceed the specification value e	Preconditioning: Run through IR reflow for 2 times. (IPC/JEDEC J-STD-020D Classification Reflow Profiles) With the component mounted on a PCB with the device to be tested, apply a force(>0805:1kg, <=0805:0.5kg)to the side of a device being tested. This force shall be applied for 60 +1 seconds. Also the force shall be applied gradually as not to apply a shock to the component being tested.  															

Note : When there are questions concerning measurement result : measurement shall be made after 48 ± 2 hours of recovery under the standard condition.

## 7. Soldering and Mounting

### 7-1. Soldering

Mildly activated rosin fluxes are preferred. TAI-TECH terminations are suitable for all wave and re-flow soldering systems. If hand soldering cannot be avoided, the preferred technique is the utilization of hot air soldering tools.

#### 7-1.1 Solder re-flow:

Recommended temperature profiles for re-flow soldering in Figure 1.

#### 7-1.2 Soldering Iron(Figure 2):

Products attachment with a soldering iron is discouraged due to the inherent process control limitations. In the event that a soldering iron must be employed the following precautions are recommended.

- Preheat circuit and products to 150°C
- Never contact the ceramic with the iron tip
- Use a 20 watt soldering iron with tip diameter of 1.0mm
- 355°C tip temperature (max)
- 1.0mm tip diameter (max)
- Limit soldering time to 4~5 sec.

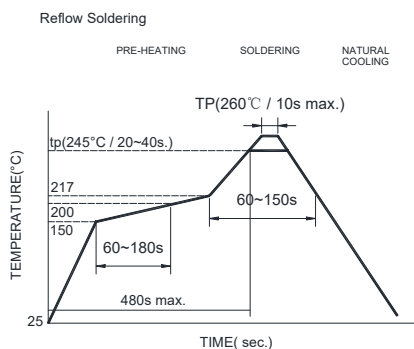

Reflow times: 3 times max.

Fig.1

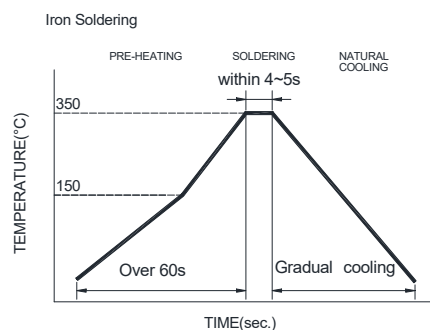

Iron Soldering times: 1 times max.

Fig.2

### 7-2. Recommended PC Board Pattern

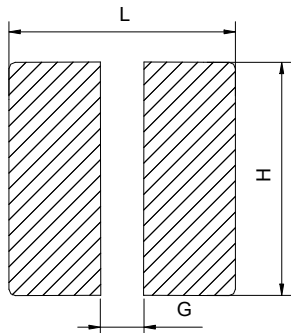

L(mm)	G(mm)	H(mm)
2.9	0.8	2.4

## 8. Packaging Information

### 8-1. Reel Dimension

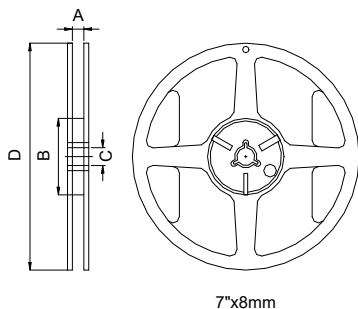

Type	A(mm)	B(mm)	C(mm)	D(mm)
7"x8mm	8.4±1.0	50 min.	13±0.8	178±2

### 8-2. Tape Dimension / 8mm

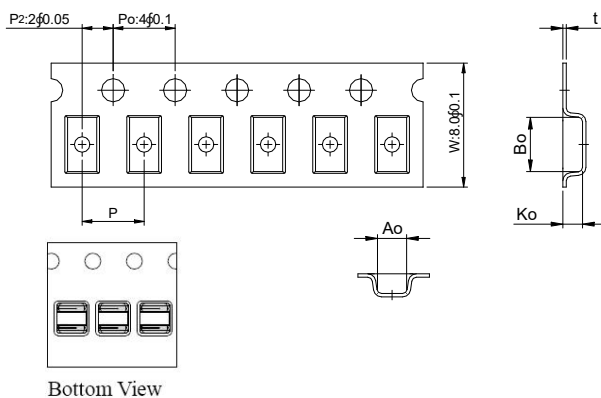

Series	Size	Bo(mm)	Ao(mm)	Ko(mm)	P(mm)	t(mm)
DFP	252012	2.85±0.1	2.45±0.1	1.40±0.1	4.0±0.1	0.23±0.05

### 8-3. Packaging Quantity

Chip size	252012
Chip / Reel	2000

### 8-4. Tearing Off Force

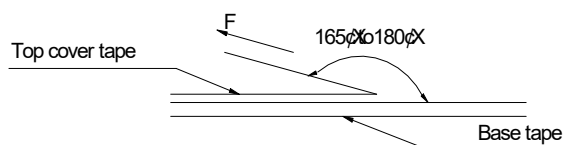

The force for tearing off cover tape is 15 to 80 grams in the arrow direction under the following conditions.

Room Temp. (°C)	Room Humidity (%)	Room atm (hPa)	Tearing Speed mm/min
5~35	45~85	860~1060	300

#### Application Notice

- Storage Conditions(component level)  
To maintain the solderability of terminal electrodes:
  1. TAI-TECH products meet IPC/JEDEC J-STD-020D standard-MSL, level 1.
  2. Temperature and humidity conditions: Less than 40°C and 60% RH.
  3. Recommended products should be used within 12 months form the time of delivery.
  4. The packaging material should be kept where no chlorine or sulfur exists in the air.
- Transportation
  1. Products should be handled with care to avoid damage or contamination from perspiration and skin oils.
  2. The use of tweezers or vacuum pick up is strongly recommended for individual components.
  3. Bulk handling should ensure that abrasion and mechanical shock are minimized.

## 9. Typical Performance Curves

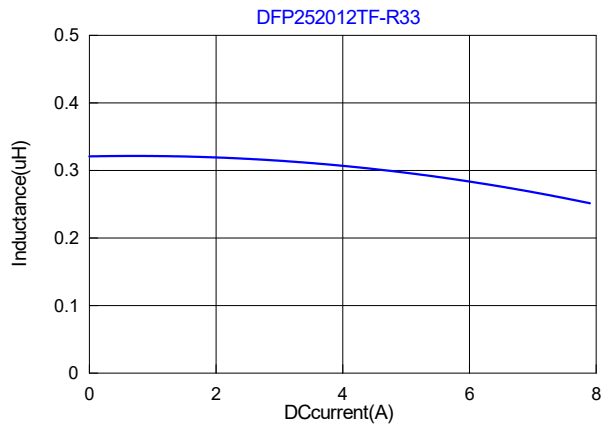



## X-ON Electronics

Largest Supplier of Electrical and Electronic Components

*Click to view similar products for [Fixed Inductors](#) category:*

*Click to view products by [Tai-Tech](#) manufacturer:*

Other Similar products are found below :

[CR32NP-151KC](#) [CR32NP-180KC](#) [CR32NP-181KC](#) [CR32NP-1R5MC](#) [CR32NP-390KC](#) [CR32NP-3R9MC](#) [CR32NP-680KC](#) [CR32NP-820KC](#) [CR32NP-8R2MC](#) [CR43NP-390KC](#) [CR43NP-560KC](#) [CR43NP-680KC](#) [CR54NP-181KC](#) [CR54NP-470LC](#) [CR54NP-820KC](#) [CR54NP-8R5MC](#) [70F224AI](#) [MGDQ4-00004-P](#) [MHL1ECTTP18NJ](#) [MHQ1005P10NJ](#) [MHQ1005P1N0S](#) [MHQ1005P2N4S](#) [MHQ1005P3N6S](#) [MHQ1005P5N1S](#) [MHQ1005P8N2J](#) [PE-51506NL](#) [PE-53601NL](#) [PE-53602NL](#) [PE-53630NL](#) [PE-53824SNLT](#) [PE-92100NL](#) [PG0434.801NLT](#) [PG0936.113NLT](#) [9220-20](#) [9310-16](#) [PM06-2N7](#) [PM06-39NJ](#) [A01TK](#) [1206CS-471XJ](#) [HC2LP-R47-R](#) [HC2-R47-R](#) [HC3-2R2-R](#) [HCF1305-3R3-R](#) [1206CS-151XG](#) [RCH664NP-140L](#) [RCH664NP-4R7M](#) [RCH8011NP-221L](#) [RCP1317NP-332L](#) [RCP1317NP-391L](#) [RCR1010NP-470M](#)