

# Specification for Approval

Date: 2021/12/21

Customer : 立创

TAI-TECH P/N: HGZ0603D121CTF

CUSTOMER P/N: \_\_\_\_\_

DESCRIPTION: \_\_\_\_\_

QUANTITY: \_\_\_\_\_

REMARK:	
Customer Approval Feedback	

西北臺慶科技股份有限公司  
**TAI-TECH Advanced Electronics Co., Ltd**

- 代理商:
- 深圳市天诚科技有限公司  
 Shenzhen TsaSun Technology Co., Ltd.  
 Room 209, 2/F, Block A, Tengfei Industrial Building, No.6,  
 Taohua Road, Futian District, Shenzhen  
 TEL: 0755-8335 8885 / 0755-8335 9885  
 E-mail: sales@tsasun.com  
 www.tsacoil.com

Sales Dep.

APPROVED	CHECKED
夏晓曼	夏晓曼

- 西北臺慶科技股份有限公司  
 TAI-TECH Advanced Electronics Co., Ltd  
Headquarter:  
 NO.1 YOU 4TH ROAD, YOUTH INDUSTRIAL DISTRICT, YANG-MEI,  
 TAO-YUAN HSIEN, TAIWAN, R.O.C.  
 TEL: +886-3-4641148 FAX: +886-3-4643565  
 http://www.tai-tech.com.tw  
 E-mail: sales@tai-tech.com.tw
- 臺慶精密電子(昆山)有限公司  
 TAI-TECH ADVANCED ELECTRONICS(KUNSHAN) CO., LTD  
 SHINWHA ROAD, KUNJIA HI-TECH INDUSTRIAL PARK, KUN-SHAN,  
 JIANG-SU, CHINA  
 TEL: +86-512-57619396 FAX: +86-512-57619688  
 E-mail: hui@tai-tech.com.tw

R&D Center

APPROVED	CHECKED	DRAWN
羅宜春	梁周虎	卜文娟

# SPECIFICATIONS

<b>Customer</b>	
<b>Product Name</b>	<b>Multi-layer Chip Ferrite Bead</b>
<b>Sunlord Part Number</b>	<b>GZ/PZ0603 Series</b>
<b>Customer Part Number</b>	

New Released,  Revised]

SPEC No.: GZPZ0101200000

**【This SPEC is total 11 pages including specifications and appendix.】**  
**【ROHS, Halogen-Free and SVHC Compliant Parts】**

Approved By	Checked By	Issued By

## Shenzhen Sunlord Electronics Co., Ltd.

Address: Sunlord Industrial Park, Dafuyuan Industrial Zone, Guanlan, Shenzhen, China 518110  
 Tel: 0086-755-29832333 Fax: 0086-755-82269029 E-Mail: sunlord@sunlordinc.com

**【For Customer approval Only】** Date: \_\_\_\_\_

Qualification Status:  Full  Restricted  Rejected

Approved By	Verified By	Re-checked By	Checked By

Comments:  
 \_\_\_\_\_

**【Version change history】**

Rev.	Effective Date	Changed Contents	Change Reasons	Approved By
01	/	New release	New products	Hai Guo

**Caution**

All products listed in this specification are developed, designed and intended for use in general electronics equipment. The products are not designed or warranted to meet the requirements of the applications listed below, whose performance and/or quality require especially high reliability, or whose failure, malfunction or trouble might directly cause damage to society, person, or property. Please understand that we are not responsible for any damage or liability caused by use of the products in any of the applications below. Please contact us for more details if you intend to use our products in the following applications.

1. Aircraft equipment
2. Aerospace equipment
3. Undersea equipment
4. nuclear control equipment
5. military equipment
6. Power plant equipment
7. Medical equipment
8. Transportation equipment (automobiles, trains, ships, etc.)
9. Traffic signal equipment
10. Disaster prevention / crime prevention equipment
11. Data-processing equipment
12. Applications of similar complexity or with reliability requirements comparable to the applications listed in the above

1. Scope

This specification applies to GZ/PZ0603 Series of multi-layer ferrite chip bead.

2. Product Description and Identification (Part Number)

- 1) Description:  
GZ/PZ0603 Series of multi-layer ferrite chip bead.
- 2) Product Identification (Part Number)

GZ    ※※※※    ○    XXX    ◎    F  
 ①            ②            ③            ④            ⑤            ⑥

① Type	
GZ	For General Use
PZ	For Large current

② External Dimensions (L X W)[mm]	
0603 [0201]	0.6 X 0.3

③ Material Code	
D, U, E	

④ Nominal Impedance	
Example	Nominal Value
300	30Ω
121	120Ω

⑤ Packing	
T	Tape Carrier Package

⑥ HSF Products	
Hazardous Substance Free Products	

3. Electrical Characteristics

Please refer to **Appendix A**.

- 1) Operating and storage temperature range (individual chip without packing): -55°C ~ +125°C.
- 2) Storage temperature range (packaging conditions):-10°C~+40°C and RH 70% (Max.)

4. Shape and Dimensions

- 1) Dimensions and recommended PCB pattern for reflow soldering: See **Fig.4-1**, **Fig.4-2** and **Table 4-1**.
- 2) Structure: See **Fig. 4-3** and **Fig. 4-4**.

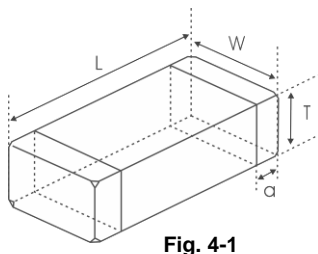

Fig. 4-1

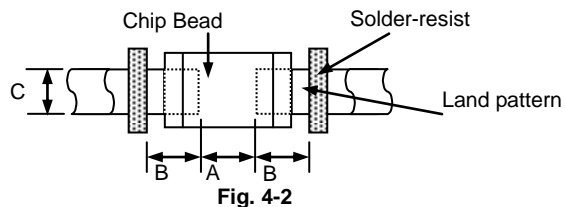

Fig. 4-2

[Table 4-1]

Unit: mm [inch]

Type	L	W	T	a	A	B	C
0603	0.6±0.05	0.3±0.05	0.3±0.05	0.15±0.05	0.2~0.3	0.2~0.3	0.3~0.35
[0201]	[.024±0.002]	[.012±.002]	[.012±.002]	[.006±.002]			

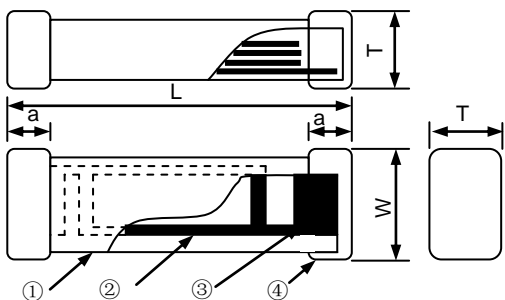

Fig. 4-3

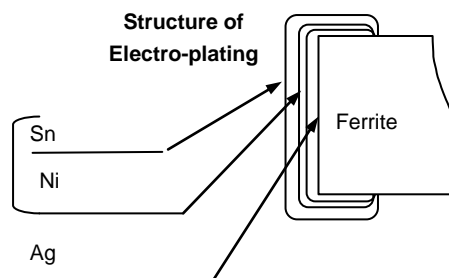

Fig. 4-4

- ① Ferrite for Bead Series
- ② Internal electrode (Ag)
- ③ Pull out electrode (Ag)
- ④-1 Terminal electrode: Inside (Ag)
- ④-2 Outside (Electro-plating Ni-Sn)

3) Material Information: See Table 4-2.

[Table 4-2]

Code	Part Name	Material Name
①	Ferrite Body	Ferrite Powder
②	Inner Coils	Silver Paste
③	Pull-out Electrode (Ag)	Silver Paste
④-1	Terminal Electrode: Inside Ag	Termination Silver Composition
④-2	Electro-Plating: Ni/Sn plating	Plating Chemicals

5. Test and Measurement Procedures

5.1 Test Conditions

5.1.1 Unless otherwise specified, the standard atmospheric conditions for measurement/test as:

- a. Ambient Temperature: 20±15°C
- b. Relative Humidity: 65±20%
- c. Air Pressure: 86kPa to 106kPa

5.1.2 If any doubt on the results, measurements/tests should be made within the following limits:

- a. Ambient Temperature: 20±2°C
- b. Relative Humidity: 65±5%
- c. Air Pressure: 86kPa to 106kPa

5.2 Visual Examination

- a. Inspection Equipment: 20x magnifier

5.3 Electrical Test

5.3.1 DC Resistance (DCR)

- a. Refer to Appendix A.
- b. Test equipment (Analyzer): High Accuracy Milliohmmeter-HP4338B or equivalent.

5.3.2 Impedance (Z)

- a. Refer to Appendix A.
- b. Test equipment: High Accuracy RF Impedance /Material Analyzer-E4991A or equivalent.  
Test fixture: HP16197A for 0603, HP16192A for 1005/1608/2012/3216.  
Test signal: -20dBm or 50mV
- c. Test frequency refers to Appendix A.

5.3.3 Rated Current

- a. Refer to Appendix A.
- b. Test equipment (see Fig.5.3.3-1): Electric Power, Electric current meter, Thermometer.
- c. Measurement method (see Fig. 5.3.3-1):
  1. Set test current to be 0 mA.
  2. Measure initial temperature of chip surface.
  3. Gradually increase voltage and measure chip temperature for corresponding current.
- d. Definition of Rated Current (Ir): Ir is direct electric current as chip surface temperature rose just 20°C against chip initial surface temperature (Ta) (see Fig. 5.3.3-2)

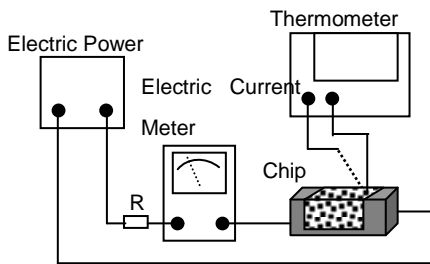

Fig. 5.3.3-1

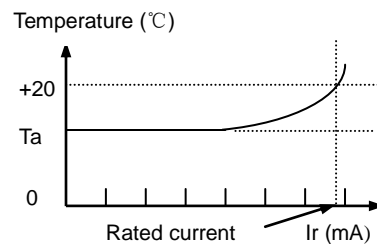
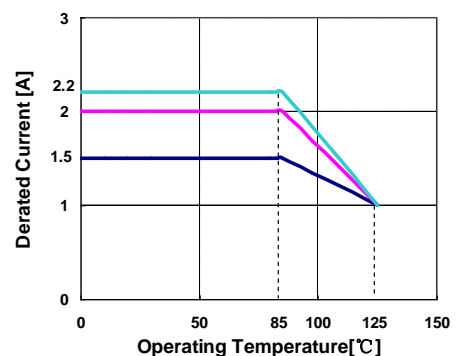
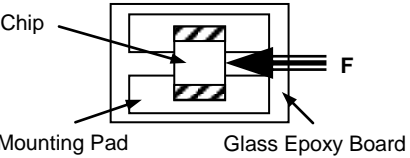
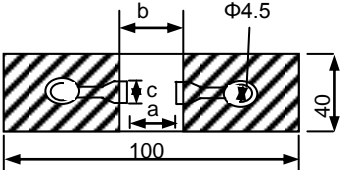
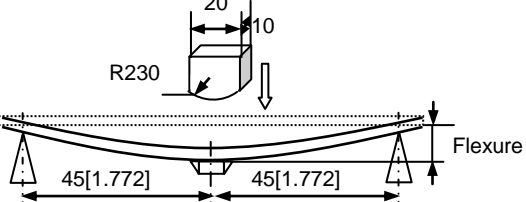
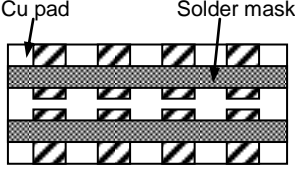

Fig. 5.3.3-2

- e. When operating temperatures exceeding +85°C, derating of current is necessary for chip ferrite beads for which rated current is 1000mA over. Please apply the derating curve shown in chart according to the operating temperature.



5.4 Reliability Test

Items	Requirements	Test Methods and Remarks								
5.4.1 Terminal Strength	No removal or split of the termination or other defects shall occur.  <p style="text-align: center;"><b>Fig.5.4.1-1</b></p>	<ol style="list-style-type: none"> <li>① Solder the bead to the testing jig (glass epoxy board shown in <b>Fig. 5.4.1-1</b>) using leadfree solder. Then apply a force in the direction of the arrow.</li> <li>② 2N force for 0603 series, 5N force for 1005 and 1608 series 10N force for 2012 and 3216 series.</li> <li>③ Keep time: 10±1s.</li> <li>④ Speed: 1.0mm/s.</li> </ol>								
5.4.2 Resistance to Flexure	No visible mechanical damage. Unit: mm [inch] <table border="1" data-bbox="328 539 756 629"> <thead> <tr> <th>Type</th> <th>a</th> <th>b</th> <th>c</th> </tr> </thead> <tbody> <tr> <td>0603[0201]</td> <td>0.25</td> <td>0.8</td> <td>0.3</td> </tr> </tbody> </table>  <p style="text-align: center;"><b>Fig. 5.4.2-1</b></p>	Type	a	b	c	0603[0201]	0.25	0.8	0.3	<ol style="list-style-type: none"> <li>① Solder the bead to the test jig (glass epoxy board shown in <b>Fig. 5.4.2-1</b>) Using a leadfree solder. Then apply a force in the direction shown <b>Fig. 5.4.2-2</b>.</li> <li>② Flexure: 2mm.</li> <li>③ Pressurizing Speed: 0.5mm/sec.</li> <li>④ Keep time: 30 sec.</li> </ol>  <p style="text-align: center;"><b>Fig. 5.4.2-2</b></p>
Type	a	b	c							
0603[0201]	0.25	0.8	0.3							
5.4.3 Vibration	<ol style="list-style-type: none"> <li>① No visible mechanical damage.</li> <li>② Impedance change: within ±20%</li> </ol>  <p style="text-align: center;"><b>Fig. 5.4.3-1</b></p>	<ol style="list-style-type: none"> <li>① Solder the bead to the testing jig (glass epoxy board shown in <b>Fig. 5.4.3-1</b>) using leadfree solder.</li> <li>② The bead shall be subjected to a simple harmonic motion having total amplitude of 1.5 mm, the frequency being varied uniformly between the approximate limits of 10 and 55 Hz.</li> <li>③ The frequency range from 10 to 55 Hz and return to 10 Hz shall be traversed in approximately 1 minute. This motion shall be applied for a period of 2 hours in each 3 mutually perpendicular directions (total of 6 hours).</li> </ol>								
5.4.4 Dropping	<ol style="list-style-type: none"> <li>① No visible mechanical damage.</li> <li>② Impedance change: within ±20%.</li> </ol>	Drop chip bead 10 times on a concrete floor from a height of 100 cm.								
5.4.5 Temperature	Impedance change should be within ±20% of initial value measuring at 20°C.	Temperature range: -55°C ~ 125°C. Reference temperature: +20°C.								
5.4.6 Solderability	<ol style="list-style-type: none"> <li>① No visible mechanical damage.</li> <li>② Wetting shall exceed 75% coverage for 0603 series; exceed 95% for others</li> </ol>	<ol style="list-style-type: none"> <li>① Solder temperature: 240±2°C</li> <li>② Duration: 3 sec.</li> <li>③ Solder: Sn/3.0Ag/0.5Cu.</li> <li>④ Flux: 25% Resin and 75% ethanol in weight.</li> </ol>								
5.4.7 Resistance to Soldering Heat	<ol style="list-style-type: none"> <li>① No visible mechanical damage.</li> <li>② Wetting shall exceed 75% coverage for 0603 series; exceed 95% for others</li> <li>③ Impedance change: within ±20%.</li> </ol>	<ol style="list-style-type: none"> <li>① Solder temperature :260±3°C</li> <li>② Duration: 5 sec.</li> <li>③ Solder: Sn/3.0Ag/0.5Cu.</li> <li>④ Flux: 25% Resin and 75% ethanol in weight.</li> <li>⑤ The chip shall be stabilized at normal condition for 1~2 hours before measuring.</li> </ol>								

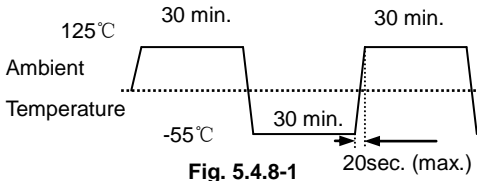
<p>5.4.8 Thermal Shock</p>	<p>① No mechanical damage. ② Impedance change: Within <math>\pm 20\%</math>.</p>  <p style="text-align: center;"><b>Fig. 5.4.8-1</b></p>	<p>① Temperature, Time: (See <b>Fig.5.4.8-1</b>) -55°C for 30±3 min→125°C for 30±3min. ② Transforming interval: Max. 20 sec. ③ Tested cycle: 100 cycles. ④ The chip shall be stabilized at normal condition for 1~2 hours before measuring.</p>
<p>5.4.9 Resistance to Low Temperature</p>	<p>① No mechanical damage. ② Impedance change: within <math>\pm 20\%</math>.</p>	<p>① Temperature: -55±2°C ② Duration: 1000<sup>+24</sup> hours. ③ The chip shall be stabilized at normal condition for 1~2 hours before measuring.</p>
<p>5.4.10 Resistance to High Temperature</p>	<p>① No mechanical damage. ② Impedance change: within <math>\pm 20\%</math>.</p>	<p>① Temperature: 125±2°C ② Duration: 1000<sup>+24</sup> hours. ③ The chip shall be stabilized at normal condition for 1~2 hours before measuring.</p>
<p>5.4.11 Damp Heat (Steady States)</p>	<p>① No mechanical damage. ② Impedance change: Within <math>\pm 20\%</math>.</p>	<p>① Temperature: 60±2°C ② Humidity: 90% to 95% RH. ③ Duration: 1000<sup>+24</sup> hours. ④ The chip shall be stabilized at normal condition for 1~2 hours before measuring.</p>
<p>5.4.12 Loading Under Damp Heat</p>	<p>① No visible mechanical damage. ② Impedance change: within <math>\pm 20\%</math>.</p>	<p>① Temperature: 60±2°C ② Humidity: 90% to 95% RH. ③ Duration: 1000<sup>+24</sup> hours. ④ Applied current: Rated current. ⑤ The chip shall be stabilized at normal condition for 1~2 hours before measuring.</p>
<p>5.4.13 Loading at High Temperature (Life Test)</p>	<p>① No visible mechanical damage. ② Impedance change: within <math>\pm 20\%</math>.</p>	<p>① Temperature: 125±2°C ② Duration: 1000<sup>+24</sup> hours. ③ Applied current: Rated current. ④ The chip shall be stabilized at normal condition for 1~2 hours before measuring.</p>

**6. Packaging, Storage**

**6.1 Packaging**

Tape Carrier Packaging:

Packaging code: T

- a. Tape carrier packaging are specified in attached figure **Fig.6.1-1~3**
- b. Tape carrier packaging quantity please see the following table:

Type	0603[0201]
T(mm)	0.3±0.15
Tape	Paper Tape
Quantity	15K

(1) Taping Drawings (Unit: mm)

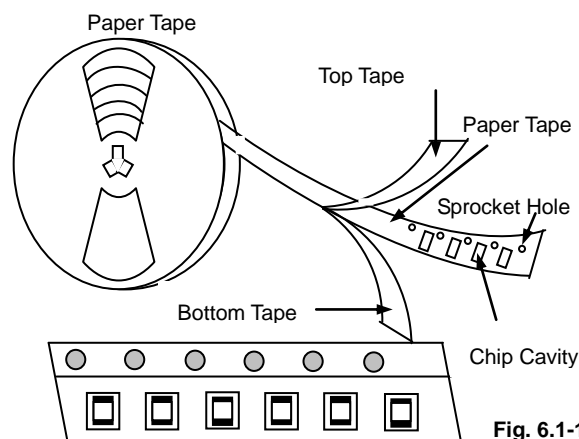

**Remark:** The sprocket holes are to the right as the tape is pulled toward the user.



(2) Taping Dimensions (Unit: mm)

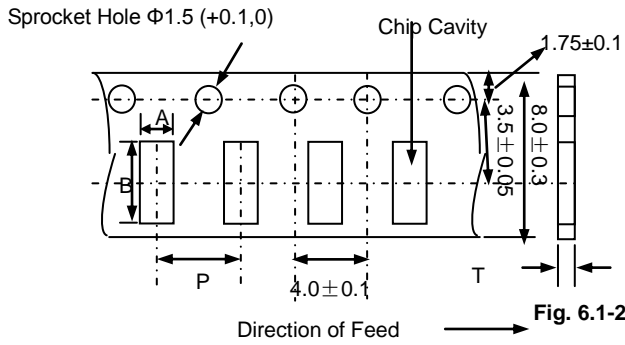

Paper Tape

Type	A	B	P	T max
0603[0201]	$0.40 \pm 0.1$	$0.70 \pm 0.1$	$2.0 \pm 0.1$	0.55

3) Reel Dimensions (Unit: mm)

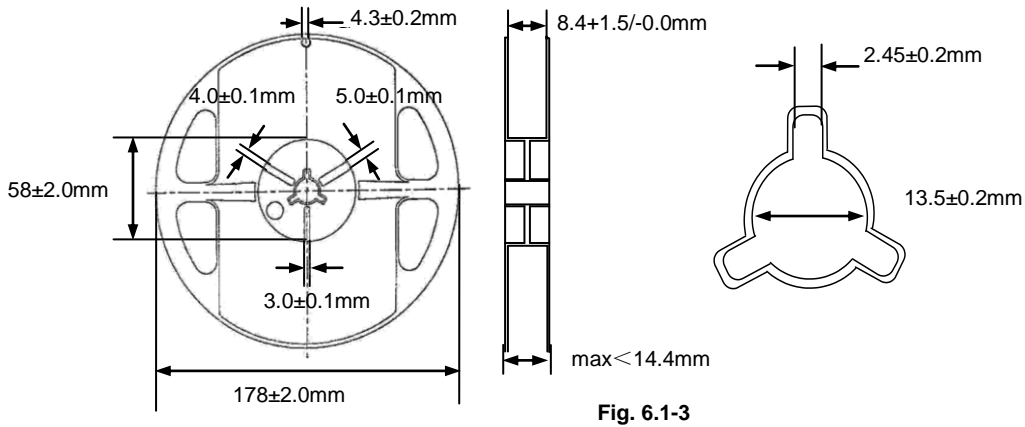

6.2 Storage

- a. The solderability of the external electrode may be deteriorated if packages are stored where they are exposed to high humidity. Package must be stored at  $40^\circ\text{C}$  or less and 70% RH or less.
- b. The solderability of the external electrode may be deteriorated if packages are stored where they are exposed to dust of harmful gas (e.g. HCl, sulfurous gas of  $\text{H}_2\text{S}$ ).
- c. Packaging material may be deformed if package are stored where they are exposed to heat of direct sunlight.
- d. Solderability specified in **Clause 5.4.6** shall be guaranteed for 6 months from the date of delivery on condition that they are stored at the environment specified in **Clause 3**. For those parts, which passed more than 6 months shall be checked solder-ability before use.

7. Recommended Soldering Technologies

7.1 Re-flowing Profile:

- △ Preheat condition:  $150 \sim 200^\circ\text{C} / 60 \sim 120$ sec.
- △ Allowed time above  $217^\circ\text{C}$ :  $60 \sim 90$ sec.
- △ Max temp:  $260^\circ\text{C}$
- △ Max time at max temp: 10sec.
- △ Solder paste: Sn/3.0Ag/0.5Cu
- △ Allowed Reflow time: 2x max

[Note: The reflow profile in the above table is only for qualification and is not meant to specify board assembly profiles. Actual board assembly profiles must be based on the customer's specific board design, solder paste and process, and should not exceed the parameters as the Reflow profile shows.]

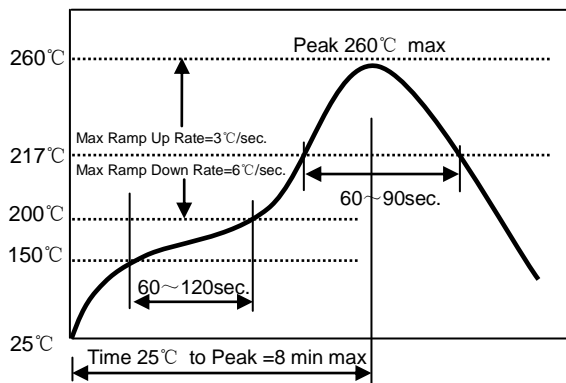

7.2 Iron Soldering Profile.

- △ Iron soldering power: Max.30W
- △ Pre-heating:  $150^\circ\text{C} / 60$ sec.
- △ Soldering Tip temperature:  $350^\circ\text{C}$  Max.
- △ Soldering time: 3sec Max.
- △ Solder paste: Sn/3.0Ag/0.5Cu
- △ Max.1 times for iron soldering

[Note: Take care not to apply the tip of the soldering iron to the terminal electrodes.]

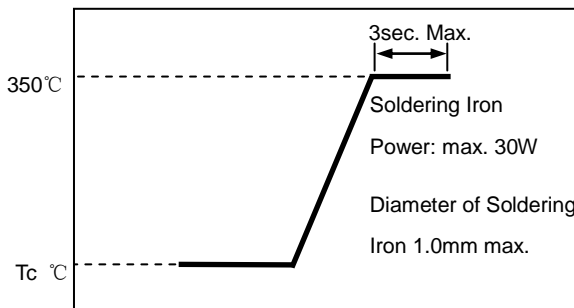

Appendix A: Electrical Characteristics

I. GZ0603-C Series of Beads

Part Number	Impedance ( $\Omega$ )	Z Test Freq. (MHz)	DCR ( $\Omega$ ) Max.	I <sub>r</sub> (mA) Max.	Thickness (mm) [inch]
GZ0603D600CTF	60±25%	100	0.3	200	0.3±0.05 [.012±.002]
GZ0603D800CTF	80±25%	100	0.4	200	
GZ0603D121CTF	120±25%	100	0.5	200	
GZ0603D241CTF	240±25%	100	0.8	200	
GZ0603D601CTF	600±25%	100	1.5	200	
GZ0603D102CTF	1000±25%	100	2.0	100	

II. PZ0603 Series of Beads

Part Number	Impedance ( $\Omega$ )	Z Test Freq. (MHz)	DCR ( $\Omega$ ) Max.	I <sub>r</sub> (mA) Max.	Thickness (mm) [inch]
PZ0603D600-R50TF	60±25%	100	0.18	500	0.3±0.05 [.012±.002]
PZ0603D800-R50TF	80±25%	100	0.20	500	
PZ0603D121-R45TF	120±25%	100	0.25	450	
PZ0603D241-R35TF	240±25%	100	0.41	350	
PZ0603D601-R25TF	600±25%	100	1.0	250	
PZ0603D102-R20TF	1000±25%	100	1.4	200	

Impedance Frequency Characteristics

GZ0603D600CTF

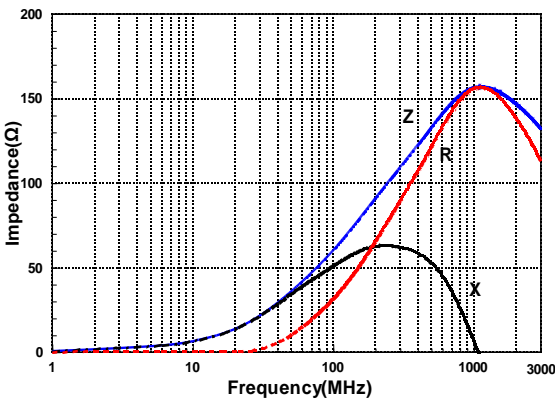

GZ0603D800CTF

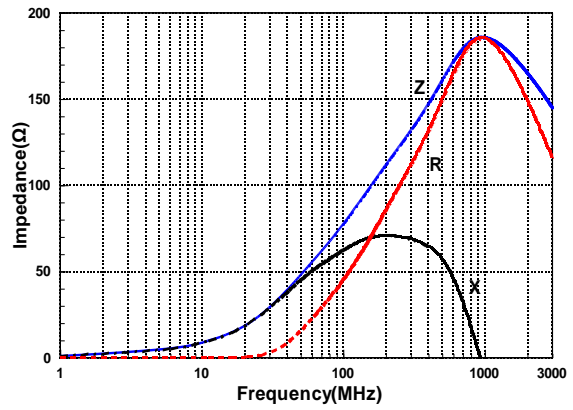

GZ0603D121CTF

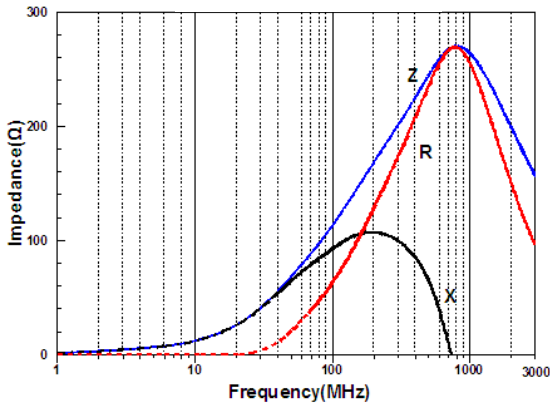

GZ0603D241CTF

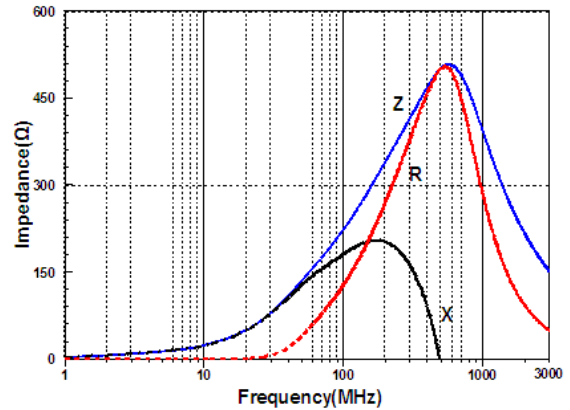

GZ0603D601CTF

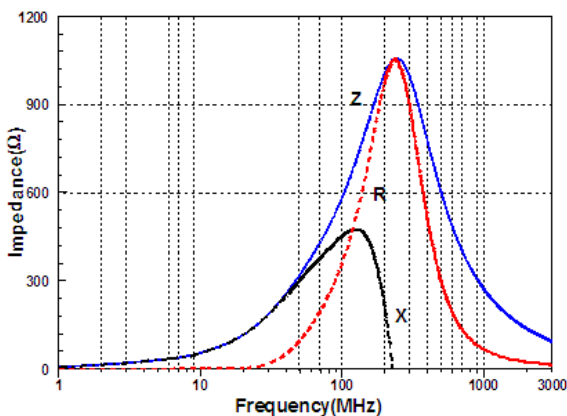

GZ0603D102CTF

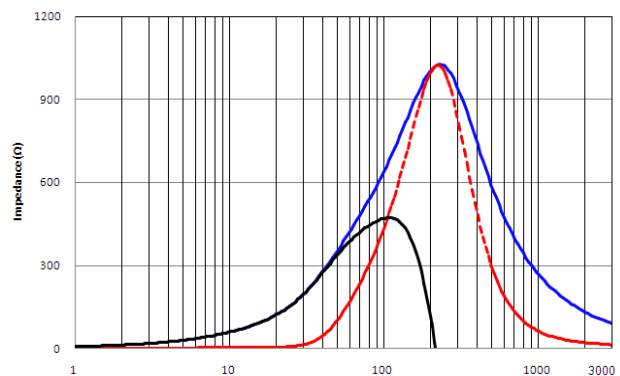

PZ0603D800-R50TF

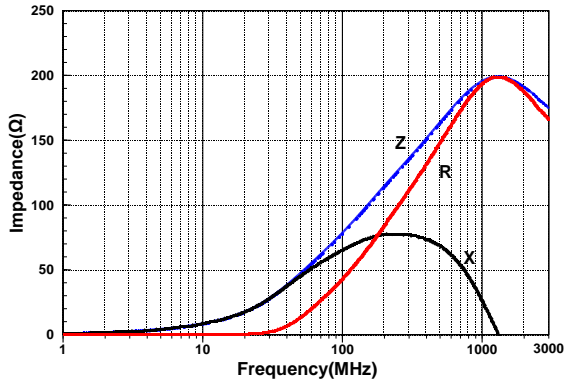

PZ0603D121-R45TF

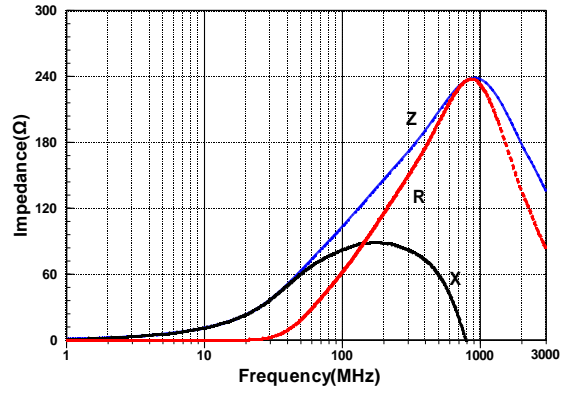

PZ0603D241-R35TF

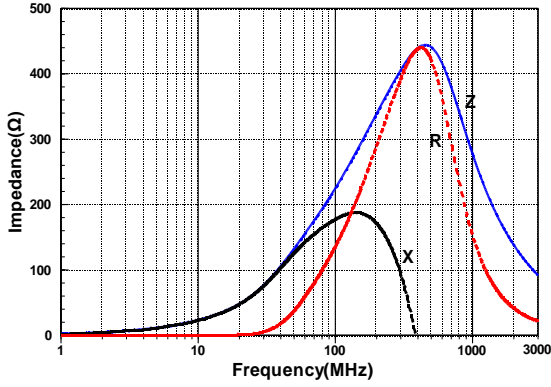

PZ0603D601-R25TF

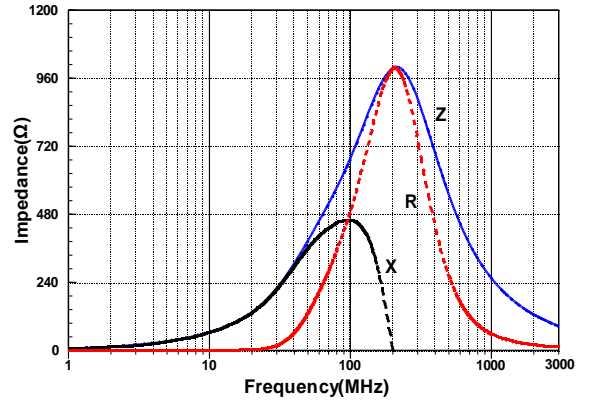

PZ0603D102-R20TF

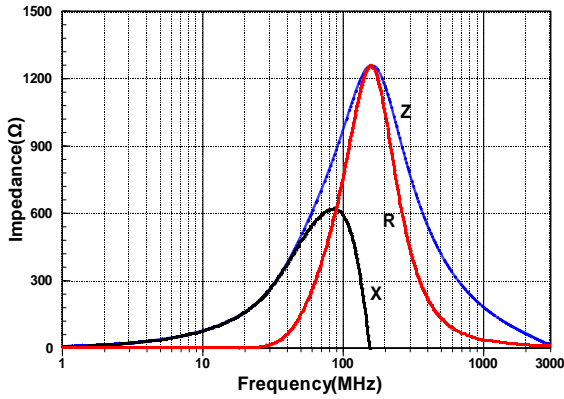

## X-ON Electronics

Largest Supplier of Electrical and Electronic Components

*Click to view similar products for [Ferrite Beads](#) category:*

*Click to view products by [Tai-Tech](#) manufacturer:*

Other Similar products are found below :

[CZB1EGTTP700P](#) [CZB1JGTTD601P](#) [CZB2AFTTD800P](#) [CZB2AGTTD121P](#) [CZB2AGTTD601P](#) [CZB2BFTTE600P](#) [PE-0402FB121ST](#)  
[NCB0603R301TR050F](#) [NCB0805A320TR050F](#) [NCB-H1206B680TR300F](#) [SMB2.5-1TR](#) [SMB2.5R-2](#) [CZB1EGTTP121P](#) [CZB1JGTTD102P](#)  
[CZB1JGTTD121P](#) [CZB1JGTTD600P](#) [CZB2AGTTD301P](#) [CZB2BFTTE301P](#) [CZB2BFTTE601P](#) [4221R-1](#) [4221R-2](#) [4221R-3](#) [432703041971](#)  
[EMI0805R-2000](#) [EMI0805R-600](#) [SBY100505T-100Y-N](#) [NCB-GH0402D121TR060F](#) [CZB2AGTTD102P](#) [NCB0402P301TR005F](#)  
[NCB0603R152TR030F](#) [NCB0805A121TR050F](#) [NCB0805A301TR070F](#) [NCB3312K900TR500F](#) [NCB-H0805A221TR300F](#) [NCB-](#)  
[H1806E181TR300F](#) [NCB0402P221TR030F](#) [NCB0402P300TR030F](#) [NCB0402P601TR030F](#) [NCB0805A102TR040F](#) [NCB1806E151TR020F](#)  
[NCB-H0402P100TR200F](#) [NCB-H0603R121TR300F](#) [NCB-H0805A220TR600F](#) [NCB-H1206B601TR200F](#) [CIM21J252NE](#) [EMI0805R-220](#)  
[74279250](#) [7427924](#) [CZB1JGTTD202P](#) [SA1206C101MBNT](#)