



製品仕様書 SPECIFICATIONS

客戶名稱：

Customer：

客戶料號：

Part Number：

產品名稱：

碳素皮膜固定電阻器

Product：

Carbon Film Fixed Resistor

大益料號：

碳素皮膜固定電阻器系列

Part Number：

RD シリーズ / RD series

RoHS 対応品
RoHS Compliant product
HF 対応品
Halogen Free product

TAI ELECTRONIC CO.,LTD. (TAIWAN)
ADD: NO. 133 NAN-KANN RD. SEC. 1,
TAIWAN R.O.C.
TEL: +886-3-322-1988~9
FAX: +886-3-352-4879
Website: <http://www.taiohm.com.tw>

DONGGUAN TAI ELECTRONIC CO.,LTD. (CHINA)
ADD: LIHENG INDUSTRIAL ESTATE QINGXI
TOWN, DONGGUAN CITY, GUANGDONG
PROVINCE, CHINA
TEL: +86-769-8731-3175~7
FAX: +86-769-8731-3179
Website: <http://www.taiohm.com.tw>

TAI-OHM ELECTRONICS (M) SDN. BHD
ADD: PLOT 564-D, LORONG PERUSAHAAN
BARU 2, KAWASAN PERUSAHAAN PERAI,
13600 PERAI, SEBERANG PERAI,
SPT, PULAU PINANG, MALAYSIA.
TEL: +604-390-0480
FAX: +604-390-1481
Website: <http://www.taiohm.com.my>

TA-I TECHNOLOGY (SU ZHOU) CO.,LTD. (CHINA)
ADD: SOUTH ZHAN-HONG BRIDGE, LU-XIANG
NORTH ROAD, SONG-LING TOWN, WU-JIANG
CITY, JIANG-SU, CHINA
TEL: +86-512-6345-7879
FAX: +86-512-6345-7869
Website: <http://www.tai.com.tw>

P.T.TAI ELECTRONIC INDONESIA
ADD: BLOK T1 E, F, Jl. Jababeka IV Cikarang
Industrial Estate Bekasi 17530, Indonesia
TEL: +62-21-8983-0123
FAX: +62-21-8983-0703
Website: pttai@cbn.net.id

TA-I TECHNOLOGY (DongGuan) CO.,LTD.
(CHINA)
ADD: 11 TEAM, SHIEM-MA CHUN, CHING-PING
TOWN, DONGGUAN CITY, GUANGTON
PROVINCE R.O.C.
TEL: +86-769-8339-4790
FAX: +86-769-8339-4794
Website: <http://www.tai.com.tw>

TA-I TECHNOLOGY CO.,LTD. (TAIWAN)
ADD: NO. 26, LANE 470, SEC 2. NANSHAN RD.
LUJHU TOWNSHIP, TAOYUAN, TAIWAN,
R.O.C.
TEL: +886-3-324-6169
FAX: +886-3-324-6167
Website: <http://www.tai.com.tw>

客戶承認章
Approval By

承認

檢印

担当者

承認

檢印

担当者

張華隆

李明

徐傑瓊

TAI ELECTRONIC CO.,LTD.

2018/5/22

表單編號: QR-031

Document No.	Document Name		Edition
TAI-RD-5006-A	RD series	Carbon Film Fixed Resistor	2018-1

Carbon Film Fixed Resistor

Table of Contents

1. Specifications	-----	3
2. Performance	-----	5
3. Construction & Dimension	-----	7
4. Color Coding Drawing	-----	12
5. Axial Taping Specification	-----	13
6. Dimension of Axial Operation	-----	14
7. Axial Taping Box	-----	15
8. Marking of Packing Box	-----	15
9. Recommend having the tin condition	-----	16
10. Notice	-----	16
11. QC Diagram	-----	17
12. Part Number Table	-----	18

Document No.	Document Name		Edition
TAI-RD-5006-A	RD series	Carbon Film Fixed Resistor	2018-1

1 — Specifications —

1.1 — Scope —

This specification applies to the Carbon Film Fixed Resistors made by TAI ELECTRONIC CO., LTD

For resistance values below 10 ohms, it shall only be applied to Nickel Metal Film.

1.2 — Type designation —

Types are designated as follows.

RD	25	T2	102	J	(B)
Type	Power Rating	Packaging Forming	Nominal Value of Resistance	Resistance Tolerance	Dimension
RD: Carbon Film Fixed Resistors	16:1/6W, 1/8W 25:1/4W 50:1/2W 1W:1W 2W:2W 3W:3W 25S:1/4WS 50S:1/2WS	T2: 26m/m Taping T5: 52m/m Taping T6: 63m/m Taping T7: 73m/m Taping Bulk: P: P-Type F: F-Type FK: FK-Type FFK: FFK-Type FKK: FKK-Type H: H-Type HB: HB-Type HK: HK-Type	100: 10Ω 101: 100Ω 102: 1KΩ 103: 10KΩ 104: 100KΩ 105: 1MΩ	G: 2% J: 5%	TAI's Code

1.3 — Rating —

The ratings of resistors are described in the following Sections. The rating of each type of resistor is indicated in each associated Tables.

-Table.1 Rating Table-

Items	Contents									
Type	1/8W	1/4	1/2W	1W	1/4WS	1/2WS	1WS	2WS	3WS	
Rated Wattage	1/8W	1/4W	1/2W	1W	1/4W	1/2W	1W	2W	3W	
Max. Operational Voltage	250	300	350	500	250	300	300	350	350	
Max. Overload Voltage	400	600	700	1000	400	500	500	600	600	
Max. Intermittence Overload Voltage	400	750	1000	1000	500	600	600	600	600	
Dielectric Withstanding Voltage	300	500	700	1000	250	300	500	500	500	
Rated Ambient Temperature	70°C									
Operating Temperature Range	-55°C to 155°C									
Resistance Tolerance	Class J ±5% / Class G ±2%									
Resistance Value Range	1Ω ~ 3.3MΩ									

Document No.	Document Name		Edition
TAI-RD-5006-A	RD series	Carbon Film Fixed Resistor	2018-1

1.3.1 –Rated Wattage–

The rated wattage is the maximum continuous power to be applied at operating temperature range. However, for the temperature above 70°C, the rated wattage shall be derated per Fig.1.

Rated Wattage (%)



-Fig.1 Derating curve-

1.3.2 –Rated Voltage–

The rated voltage is denoted as D.C. or rms A.C. voltage which is calculated according to the following formula. However, it is limited to the maximum applicable voltage.

$$E = \sqrt{P \times R}$$

E: Rated voltage (V)

P: Rated wattage (W)

R: Rated Resistance (Ω)

1.3.3 –Rated Resistance–

- (1). The rated resistance is specified in accordance with the E24 Series Numbers as shown in Table2.
- (2). The manufacturing resistance range is shown in each associated rating Tables.
- (3). The resistance tolerance is shown in each associated rating Tables.

-Table.2 E-24 Series resistance Value-

Effective Numerical Values of Rated Resistance											
1.0	1.1	1.2	1.3	1.5	1.6	1.8	2.0	2.2	2.4	2.7	3.0
3.3	3.6	3.9	4.3	4.7	5.1	5.6	6.2	6.8	7.5	8.2	9.1

Document No.	Document Name		Edition
TAI-RD-5006-A	RD series	Carbon Film Fixed Resistor	2018-1

2 — Performance —

No.	Item		Spec. Level	Test Method (JIS-C-5202)						
1	Resistance Value		Within the tolerance	Par. 5.1 Applicable voltage Category A.						
2	Temperature characteristics of resistance		See the rating Tables	Par. 5.2 measured at the room temperature and + 100°C . Designations of T.C.R. are shown in Par. 5.2.2(2) (a).						
3	Short time overload		Tolerable change within $\pm(1\% + 0.05\Omega)$. No visual damage & marking be legible.	Par. 5.5 Condition A (2.5 times, 5sec). Maximum overload voltages are shown in the rating Tables.						
4	Dielectric withstanding voltage		Flash over, burning or insulation damages should not be observed.	Par. 5.7 Condition A (V-blocks). Test voltage is shown in the rating Tables. Load period: 5sec.						
5	Pulse		Tolerable change within $\pm(1\% + 0.05\Omega)$ & marking be legible	Par. 5.8 Applicable only to 100 Ω or higher. The pulse voltage applied is 4 times of the rated voltage. The maximum pulse voltage is shown in the rating Tables. Pulse frequency : 10,000 \pm 200 cycles.						
6	Terminal Strength	Pull	Lead broken or terminal loosen should not be observed.	Par. 6.1.2(1) Not applicable to formed leads. Force applied for 16 to 5 sec.						
		Bend		Par.6.1.2(4) Not applicable to formed leads.						
7	Resistance to soldering heat		Tolerable change within $\pm(1\% + 0.05\Omega)$. No mechanical damage & no notable damage be observed in appearance	Par. 6.4 Select from the following conditions: Normally condition A is used. <table style="margin-left: 40px;"> <tr> <td>Temp</td> <td>Time</td> </tr> <tr> <td>A 350\pm10°C</td> <td>3.5\pm0.5 Sec</td> </tr> <tr> <td>B 260\pm5°C</td> <td>10\pm1 Sec</td> </tr> </table> Dipping be continuously applied from one lead to others. Cooling after dipping should be 3Hrs.	Temp	Time	A 350 \pm 10°C	3.5 \pm 0.5 Sec	B 260 \pm 5°C	10 \pm 1 Sec
Temp	Time									
A 350 \pm 10°C	3.5 \pm 0.5 Sec									
B 260 \pm 5°C	10 \pm 1 Sec									
8	Solderability		4/5 area of circular surface be wet with new solder.	Par. 6.5 Solder temperature: 245 \pm 5°C . Dip period: 3 \pm 0.5 Sec. Dipping is applied for one terminal at a time. Pre-treatment should not be made. Examined visually.						

Document No.	Document Name		Edition
TAI-RD-5006-A	RD series	Carbon Film Fixed Resistor	2018-1

No.	Item	Spec. Level	Test Method (JIS-C-5202)								
9	Temperature cycling	$\Delta R \leq \pm(1\% + 0.05\Omega)$. No mechanical damage be observed & marking be legible.	Par. 7.4 Temperature: $-55\pm 3^{\circ}\text{C}$ to $155\pm 2^{\circ}\text{C}$ Cycles: 5 times.								
10	Humidity load life	No remarkable abnormalities on appearance. Marking shall be Legible Variation of resistance($5\% + 0.1\Omega$)	Temperature: $85\pm 2^{\circ}\text{C}$ Relative humidity: 85% to 90% Duration: 500 +24 -0 h								
11	Load life	No remarkable abnormalities on appearance. Marking shall be Legible Variation of resistance($5\% + 0.1\Omega$)	Par. 7.10 Ambient temp: $70\pm 2^{\circ}\text{C}$. Testing period: 1,000 + 48 Hrs. 1,000 - 0 Hrs.								
12	Solvent test	No notable change in appearance & marking be legible.	JIS-C-5202 does not specify this item. Solvent used: Trichloride ethane (1:1:1) or Freon TE Ultra sonic used: 28KHz, 200W. Dip time period: 1 Min.								
13	Terminal Strength (A) Tensile Strength (B) Bending Strength (C) Tensional Strength	$\pm(1\% + 0.05\Omega)$ No cap missing and terminal wire breakage shall occur $\pm(1\% + 0.05\Omega)$ No terminal wire loosening and breakage shall occur $\pm(1\% + 0.05\Omega)$ No terminal wire loosening and breakage shall occur	Tensile strength 2.5KG is maintained for 30 seconds Bending strength 500g load 90° reciprocation twice Tensional strength 360° 5 times								
14	Packaging Drop Down Experiment	Packaging box and isolation coating resistor didn't broken. Resistance value variation $\pm (3\% + 0.05\Omega)$.	From height 30 cm, falling the goods and repeat 3 times								
15	Resistance value change per year	The resistor in the room temperature for 1 year.	Resistance value variation $< \pm 1\%$								
16	Noise test	Noise shall measured by Resistor noise test set model 315c by Quan-Tech Div. Max Vr shall be 30dB	<table border="1"> <thead> <tr> <th>Resistance</th> <th>Noise</th> </tr> </thead> <tbody> <tr> <td>$\leq 10\text{K ohm}$</td> <td>5dB(1.8$\mu\text{V/V}$)</td> </tr> <tr> <td>$\leq 100\text{K ohm}$</td> <td>10dB(3.2$\mu\text{V/V}$)</td> </tr> <tr> <td>$\leq 1.0\text{M ohm}$</td> <td>15dB(5.6$\mu\text{V/V}$)</td> </tr> </tbody> </table>	Resistance	Noise	$\leq 10\text{K ohm}$	5dB(1.8 $\mu\text{V/V}$)	$\leq 100\text{K ohm}$	10dB(3.2 $\mu\text{V/V}$)	$\leq 1.0\text{M ohm}$	15dB(5.6 $\mu\text{V/V}$)
Resistance	Noise										
$\leq 10\text{K ohm}$	5dB(1.8 $\mu\text{V/V}$)										
$\leq 100\text{K ohm}$	10dB(3.2 $\mu\text{V/V}$)										
$\leq 1.0\text{M ohm}$	15dB(5.6 $\mu\text{V/V}$)										

Document No.	Document Name		Edition
TAI-RD-5006-A	RD series	Carbon Film Fixed Resistor	2018-1

No	Item	Spec. Level	Test Method (JIS-C-5202)
17	High temperature storage test	No remarkable abnormalities on appearance. Marking shall be Legible Variation of resistance(5% + 0.1Ω)	In the 155°C for 1000 hours
18	Low temperature storage test	No remarkable abnormalities on appearance. Marking shall be Legible Variation of resistance(5% + 0.1Ω)	In the -55°C for 1000 hours
19	Temperature humidity storage test	No remarkable abnormalities on appearance. Marking shall be Legible Variation of resistance(5% + 0.1Ω)	In the chamber having temp. 60°C and relative humidity 90% for 1000 hours
20	Vibration test	$\Delta R \leq \pm(1\% + 0.05\Omega)$. No mechanical damage be observed & marking be legible	Apply 1.5mm amplitude vibration to three directions perpendicular to each other 2 hours each, total 6 hours. Vibrating frequency is 10Hz-55Hz-10Hz cycle in 1 minute sweeping and repeat cycle.

3 – Construction, Dimensions –

3.1 – Construction –

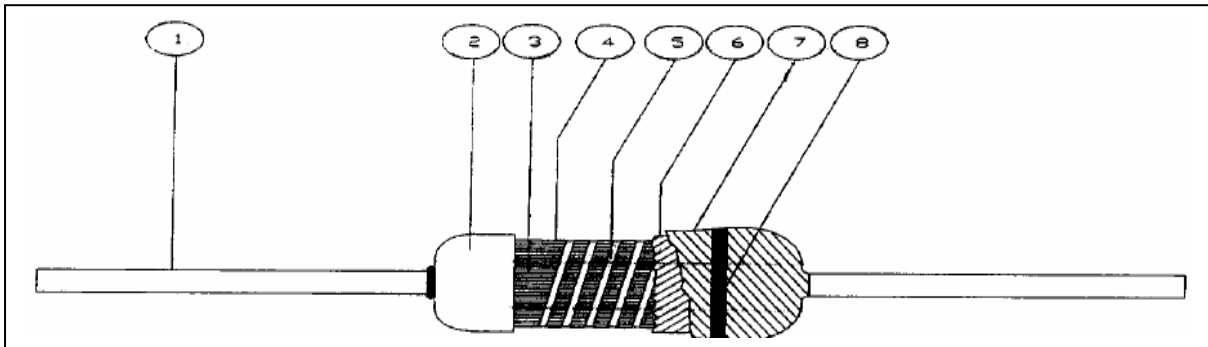

NO.	Name	Material	Remark
1	Lead wire	Solder plated copper wire	Pb-free
2	Cap	Iron/Tin	Tin plating
3	Ceramic core	Aluminum base	
4	Conductive film	Carbon, Nickel for 10	
5	Helical cutting groove		
6	Medium coat Phonemic	Phenolic	Moisture-proof
7	Insulation coat	Epoxy	insulation
8	Color code	Epoxy	

Document No.	Document Name		Edition
TAI-RD-5006-A	RD series	Carbon Film Fixed Resistor	2018-1

3.2 –Dimension– (P-Type)

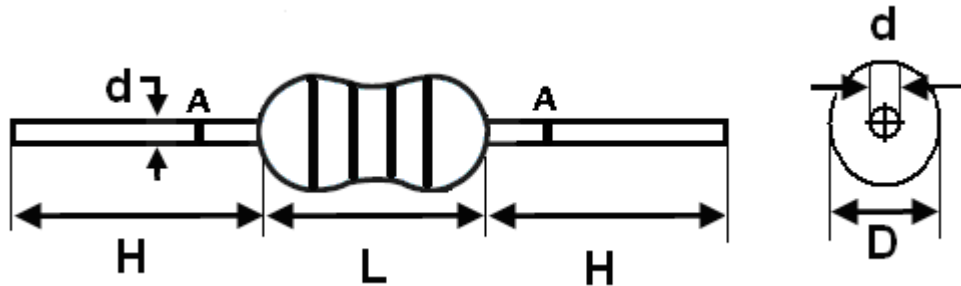

P- TYPE		Dimension (mm)				
		L (Max)	D (Max)	d±0.1	H±3	A (阻值測量點)
RD 1/6W(1/8W)	RD 1/4WS	4.7	2.5	0.43	27	5.5
RD 1/4W	RD 1/2WS	7.2	3.5	0.52	27	5.0
RD 1/2W	RD 1WS	10.5	4.0	0.56	26	3.0
RD 1W	RD 2WS	12.5	5.0	0.73	30	4.0
RD 2W	RD 3WS	16.5	5.5	0.73	30	8.0
RD 3W	RD 5WS	19.5	6.5	0.73	30	7.0

–Dimension– (F-Type)

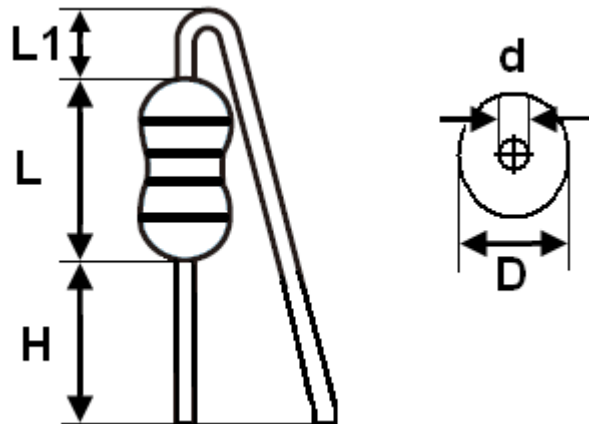

F TYPE		Dimension (mm)				
		L (Max)	L1 (Max)	D (Max)	d±0.1	H±0.5
RD1/2W	RD1WS	10.5	3.0	4.0	0.56	4.0
RD1W	RD2WS	12.5	3.5	5.0	0.73	4.0
RD2W	RD WS	16.5	3.5	5.5	0.73	4.0
RD3W	RD5WS	19.5	3.5	6.5	0.73	4.0

Document No.	Document Name		Edition
TAI-RD-5006-A	RD series	Carbon Film Fixed Resistor	2018-1

—Dimension— (FK-Type)



FK TYPE		Dimension (mm)					
		L (Max)	L1 (Max)	H±0.5	D (Max)	d±0.1	h±0.5
RD 1/2W	RD 1WS	10.5	3.0	8.0	4.0	0.56	4.0
RD 1W	RD 2WS	12.5	3.5	8.0	5.0	0.73	4.0
RD 2W	RD 3WS	16.5	3.5	8.0	5.5	0.73	4.0
RD 3W	RD 5WS	19.5	3.5	8.0	6.5	0.73	4.0

—Dimension— (FFK-Type)



FFK TYPE		Dimension (mm)					
		L (Max)	L1 (Max)	H±0.5	D (Max)	d±0.1	h±0.5
RD1/2W	RD1WS	10.5	3.0	4.0	4.0	0.56	4.0
RD1W	RD2WS	12.5	3.5	4.0	5.0	0.73	4.0
RD2W	RD3WS	16.5	3.5	4.0	5.5	0.73	4.0
RD3W	RD5WS	19.5	3.5	4.0	6.5	0.73	4.0

Document No.	Document Name		Edition
TAI-RD-5006-A	RD series	Carbon Film Fixed Resistor	2018-1

—Dimension— (FKK-Type)



FKK TYPE		Dimension (mm)					
		L (Max)	L1 (Max)	D (Max)	d±0.1	H±1	h±0.5
RD1/2W	RD1WS	10.5	3.0	4.0	0.56	8.0	4.0
RD1W	RD2WS	12.5	3.5	5.0	0.73	8.0	4.0
RD2W	RD3WS	16.5	3.5	5.5	0.73	8.0	4.0
RD3W	RD5WS	19.5	3.5	6.5	0.73	8.0	4.0

—Dimension— (H-Type)

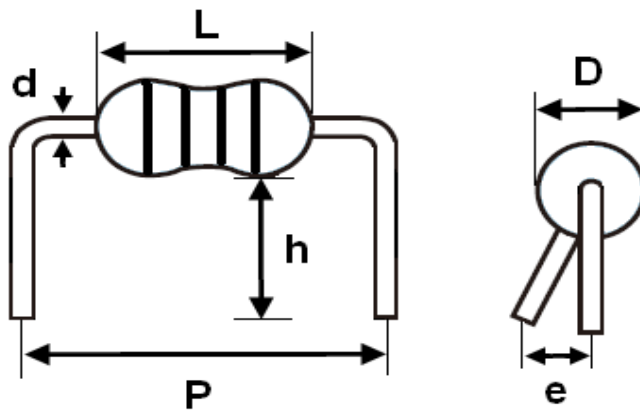

H TYPE		Dimension (mm)					
		P±1.5	h±0.5	e (Max)	d±0.1	D(Max)	L (Max)
RD 1/2W	RD 1WS	12.5	4.0	3.0	0.56	4.0	10.5
RD 1W	RD 2WS	15.0	4.0	3.0	0.73	5.0	12.5
RD 2W	RD 3WS	20.0	4.0	3.0	0.73	5.5	16.5
RD3W	RD5WS	23.0	8.5	3.0	0.73	6.5	19.5

Document No.	Document Name		Edition
TAI-RD-5006-A	RD series	Carbon Film Fixed Resistor	2018-1

—Dimension— (HB-Type)



HB TYPE		Dimension (mm)							
		P±1	H1±1.0	H2±1.0	t (Min)	e (Max)	d±0.1	D (Max)	L (Max)
RD1/2W	RD1WS	12.5	10.0	5.0	1.2	3.0	0.56	4.0	10.5
RD1W	RD2WS	15.0	10.0	5.0	1.2	3.0	0.73	5.0	12.5
RD2W	RD3WS	20.0	10.0	5.0	1.2	3.0	0.73	5.5	16.5
RD3W	RD5WS	23.0	10.0	5.0	1.2	3.0	0.73	6.5	19.5

—Dimension— (HK-Type)



HK TYPE		Dimension (mm)							
		P±1.5	H1±1.0	H2±0.5	W (Min)	d±0.1	e (Max)	D (Max)	L (Max)
RD1/2W	RD1WS	12.5	8.5	4.0	1.0	0.56	3.0	4.0	10.5
RD1W	RD2WS	15.0	11.0	4.0	1.0	0.73	3.0	5.0	12.5
RD2W	RD3WS	20.0	11.0	4.0	1.0	0.73	3.0	5.5	16.5
RD3W	RD5WS	23.0	11.0	4.0	1.0	0.73	3.0	6.5	19.5

Document No.	Document Name		Edition
TAI-RD-5006-A	RD series	Carbon Film Fixed Resistor	2018-1

4 —Color Coding Drawing—



Color	1 st No.	2 nd No.	3 rd No.	Multipliers	Tolerance
Black	0	0	0	10^0	
Brown	1	1	1	10^1	
Red	2	2	2	10^2	G ($\pm 2\%$)
Orange	3	3	3	10^3	
Yellow	4	4	4	10^4	
Green	5	5	5	10^5	
Blue	6	6	6	10^6	
Purple	7	7	7		
Gray	8	8	8		
White	9	9	9		
Gold				10^{-1}	J ($\pm 5\%$)
Silver				10^{-2}	

Document No.	Document Name		Edition
TAI-RD-5006-A	RD series	Carbon Film Fixed Resistor	2018-1

5 —Axial Taping Specification—

5.1 —Application—

This specification covers the axial taping operation for the coated insulated fixed carbon film resistors.

5.2 —Taping Operation—

Dimension of tape is shown in Fig. 4 and tapes are paper-based pressure adhesive tapes of the following requirements.

- (1). Width: $6.0 \pm 0.5 \text{ mm}$
- (2). Thickness: $0.15 \pm 0.05 \text{ mm}$
- (3). Adhesive power: 1700g/25mm wide Min.
- (4). Pull strength: 20.4g/25mm wide Min.
- (5). Elongation: 5% Max.

5.3 —Operation Requirements—

- (1). Color code orientation is not specified.
- (2). No drop out is permissible.
- (3). Adhesion length indicated as "t" shall be 3.2mm (min.) shown in Fig. 4.
- (4). Tape splicing is done by reinforcing tapes attached with both side as shown in Fig. 2.
- (5). Taping end indicated as "Z" shall have 2mm (max.) at the end of leading tape.

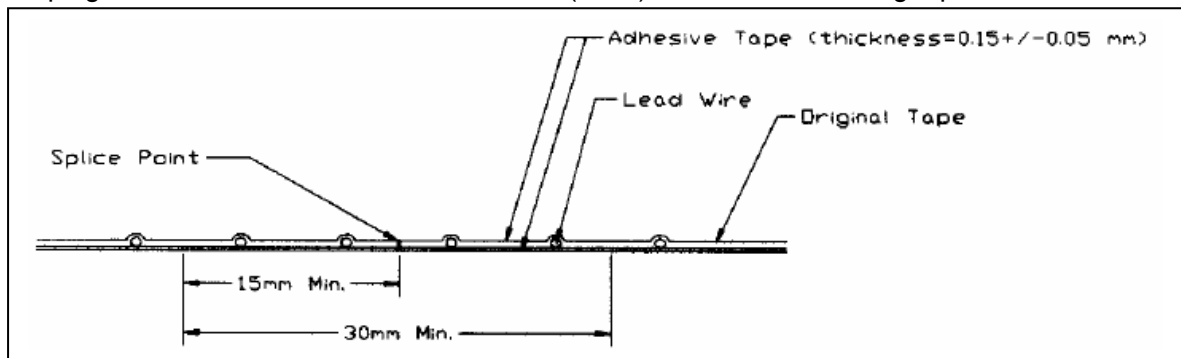

-FIG.2 Splicing of Tape Operation-

5.4 —Taped Packing—

- (1). Taped products are folded into the packing box as shown in Fig. 3.
- (2). Dimensions of boxes are shown in Fig.5 as well as Table 4.
- (3). Flap of the box is firmly taped.

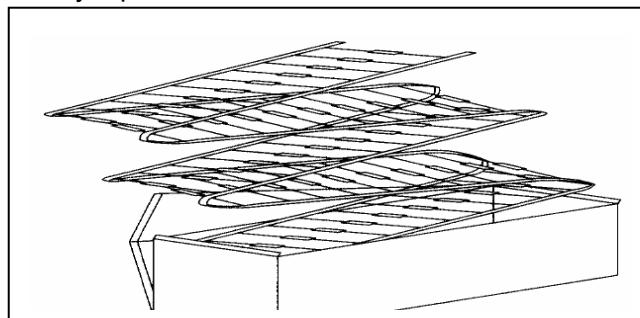

-FIG.3 Box Packing-

Document No.	Document Name		Edition
TAI-RD-5006-A	RD series	Carbon Film Fixed Resistor	2018-1

6 —Dimension of Axial Operation—



-FIG.4 Taping specifications-

-Table.3 Taping dimensions (Axial taping)-

MARK	Dimension (mm)							
	A±1	W±1	T±0.5	t-Min	L1-L2(Max)	P±0.5	Z-Max	L-Max
T26	38	26	6.0	2.0	1.0	5.0	1.0	1.0
T52	64	52	6.0	2.0	1.0	5.0	1.0	1.0
T63	75	63	6.2	2.0	1.0	5.0	1.0	1.0
T73	86	73	6.2	2.0	1.0	10.0	1.0	1.0

(1) Integrated pitch tolerance is $\pm 2\text{mm}/20$ pitches (p) $\pm 1.6\text{mm}/20$ pitches (u).

(2) Absolute values of difference between 1 and 2.

(3) Adhesive length of lead wire.

(4) Tape snaking to tolerance is $0.5\text{mm}/300\text{mm}$. -

Document No.	Document Name		Edition
TAI-RD-5006-A	RD series	Carbon Film Fixed Resistor	2018-1

7 –Axial Taping Box–



-FIG.5 Packing Box -

Table.4 Box Dimension-

Type		Quantity	MOQ (PCS)	H±5	L±10	W±5
RD 1/8W Taping (26mm)	RD 1/4WS Taping (26mm)	5,000 pcs	125,000	78	255	50
RD 1/4W Taping (26mm)	RD 1/2WS Taping (26mm)	5,000 pcs	120,000	105	255	50
RD 1/8W Taping (52mm)	RD 1/4WS Taping (52mm)	5,000 pcs	100,000	78	255	80
RD 1/4W Taping (52mm)	RD 1/2WS Taping (52mm)	5,000 pcs	55,000	110	255	80
RD 1/2W Taping (52mm)	RD 1WS Taping (52mm)	2,000 pcs	30,000	88	255	80
RD 1W Taping (63mm)	RD 2WS Taping (63mm)	1,000 pcs	15,000	85	255	87
RD 2W Taping (73mm)	RD 3WS Taping (73mm)	1,000 pcs	15,000	105	255	100

8 –Marking of Packing Box–

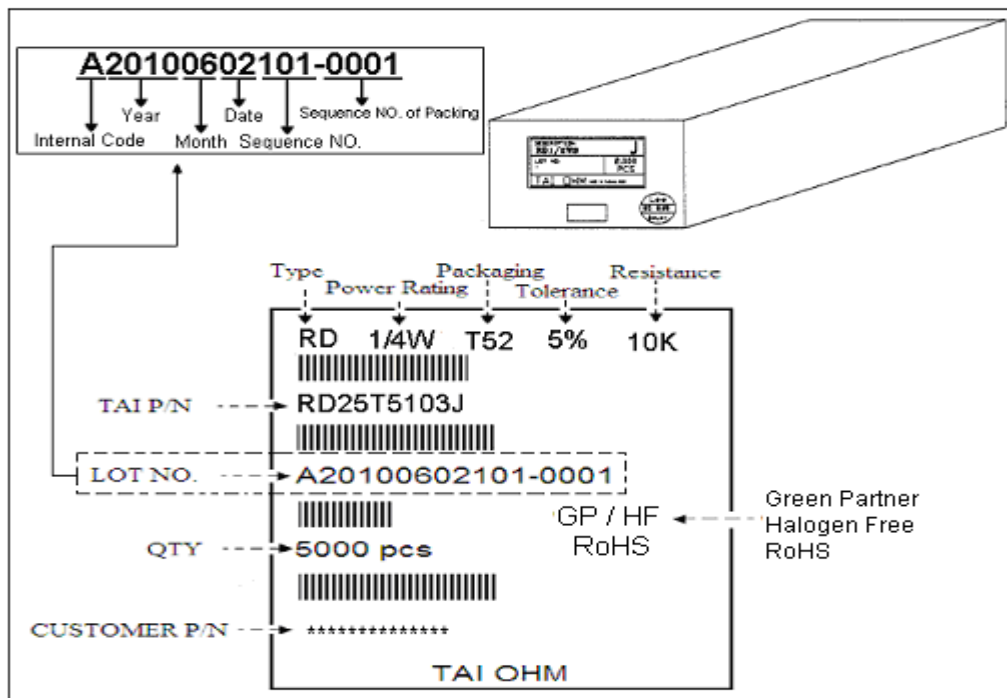

-FIG.6 Product label-

Document No.	Document Name		Edition
TAI-RD-5006-A	RD series	Carbon Film Fixed Resistor	2018-1

9. Recommend having the tin condition:

9.1. Weld the homework in crest

Whether preheat temperature. 110 °C max

Time of preheating: 60sec~120sec

The temperature of the homework / time: 260 °C / 10sec 1 second or 5sec two times

(Weld the curve and see and leave pursuing in relevant crests)



9.2. Soldering tin homework of the craft:

Soldering tin temperature: 350°C max

Soldering tin time: 3sec max

10 - Notice -

(1) Storage of resistors

Preferable storage conditions are follows: Temperature range is from 0°C to 30°C and the relative humidity (RH) is less than 65%. High temperature and humidity will change the resistance and cause poor solderability. Storage duration should be less than 2 year for the best performance.

(2) Loading conditions

Resistance change is highly dependent upon the loading conditions, such as temperature and load ratio. For long time stability, the derated conditions shall be applied. The resistor is flameproof, but care should be taken for safety. Safety resistors are available upon inquiry.

(3) Resistor insertion

Cares to be taken at the insertion time in order to prevent from the damages on coating and lead wires. Such a damages will cause the malfunctions. To bend the lead wires and keep an adequate radius is required to prevent the damages from welding points. Soldering heat applied should be minimize

(4) Moisture-proof, damp-proof, and sour-proof, to avoid the sun light directly in a long time.

(5) Open the resistor or box, the resistors cannot expose in the air for a long time. To avoid electrode and lead wire attached the substances or oxidize problem, cause the electrode and lead wire tin-plated NG.

(6) A pile of the resistors, the pressure cannot exceed 7 KG.

(7) When the goods used a adhesive tape or colors, it can use many colors excluding red and yellow color. (except color code).

(8) The components made by TAI have been widely applied in the field of home appliance, automotive appliance, telecommunication, data...etc..

(9) Specification given herein may be changed at any time without prior notice please confirm TAI before you order or use.

11. – QC Diagram –

Dept.	Q.A.	Date	1998/10/05	DIP Resistor QC Diagram		Amendment	2010/07/09	NO.	WI-QC-01	
Version	3 rd							Page	1 OF 1	
Flow		Process	Equipment	Management Item	Related Document	Inspected Frequency	Control Method	Record Department	Exceptional Method	
Ex-Station	Station								Ex-Station	Station
		IQC	Measured Instrument	Dimension Appearance Character	IQC Standard Incoming Standard	1 time/Lot	MSI/ASQC.Z1.4 I Level	Sampling Record Form Incoming Quality Exceptional Form	QC	Refuse Special
		Cutting	Automatic Cutting Machine	Appearance Resistance	Cutting Standard Inspection Standard	1 time/Lot	10× Magnifying glass Check Machine	Subpoena	PL1	Revise
		Cutting Inspection	10× Magnifying glass Check Machine	Appearance Resistance	Produce Control Standard Inspection Standard	1 time/Lot	Appearance: MSI/ASQC.Z1.4 II Level Character: MSI/ASQC.Z1.4S-2 Level	Subpoena Over % Resistance Form Quality Exceptional Form	QC	Revise Stop
		QC: Cutting Inspection	10× Magnifying glass Check Machine Electronic Scale	Appearance Resistance	Produce Control Standard Inspection Standard	1 time/Lot	Appearance: MSI/ASQC.Z1.4 II Level Character: MSI/ASQC.Z1.4S-2 Level	Subpoena Quality Examine in Cutting Section Form Over % Resistance Form Quality Exceptional Form	QC	Revise Stop
		Welding	Automatic Welding Machine Caliber Tension Instrument	Appearance Dimension Tension Diameter Copper Length	Welding Standard Appearance Check Diagram	1 time/Lot	Tension Instrument 10× Magnifying glass	Subpoena	PL1	Revise
		Welding Inspection	Tension Instrument Caliber 10× Magnifying glass	Appearance Dimension Tension Diameter Copper Length	Produce Control Standard Inspection Standard	1 time/Lot	Appearance: MSI/ASQC.Z1.4 II Level Character: MSI/ASQC.Z1.4S-2 Level	Subpoena Quality Exceptional Form Test Summary	QC	Revise Stop
		Coating	Coating Machine	Character Appearance Dimension Resistance	Coating Standard Coating % Standard	100% Check	Voltage Form Check Machine Model Board Visual Inspection 2 Phenolic layers 4 Coating layers	Subpoena	PL1	Revise
		Coating Inspection	Voltage Form Check Machine Model Board	Appearance Dimension Resistance	Produce Control Standard Inspection Standard	1 time/Lot	Appearance: MSI/ASQC.Z1.4 II Level	Subpoena Quality Exceptional Form Test Summary	QC	Revise Stop
		Forming	Forming Machine	Appearance Dimension	Forming Standard	1 time/Lot	Caliber Visual Inspection	Subpoena	PL1	Revise
		Forming Inspection	Caliber	Appearance Dimension	Inspection Standard Produce Control Standard	1 time/Lot	Appearance: MSI/ASQC.Z1.4 II Level Character: MSI/ASQC.Z1.4S-2 Level	Subpoena Quality Exceptional Form Test Summary	QC	Revise Stop
		Packaging	Model Board	Appearance	Packaging Standard	100% Check	Visual Inspection	Subpoena	QC	Revise
		Final Quality Control	Tension Instrument Caliber Model Board Check Machine	Appearance Dimension Quantity Resistance Tension	Inspection Standard Final Inspection for Goods Standard	Sampling of Character 100% Appearance Check	Appearance 100% Visual Inspection Character: MSI/ASQC.Z1.4S-3 Level	Subpoena Final Check Quality Exceptional Form	QC	Return Unusable
		Outgoing Inspection		Description Specification Quantity Part Number	Inspection Standard	100% Check	Visual Inspection	Test Report Quality Exceptional Form Test Summary	QC	Return

12. —Part Number Table —

NO.	Customer P/N	TAI P/N	Remark
1			
2			
3			
4			
5			
6			
7			
8			
9			
10			
11			
12			
13			
14			
15			
16			
17			
18			
19			
20			
21			
22			
23			
24			
25			
26			
27			
28			
29			
30			

X-ON Electronics

Largest Supplier of Electrical and Electronic Components

Click to view similar products for [Carbon Composition Resistors](#) category:

Click to view products by [TA-I Tech](#) manufacturer:

Other Similar products are found below :

[OG5625](#) [OB1025](#) [OC2255](#) [OH6205](#) [RC0S2CA270RKE](#) [RC1/4272KB](#) [OF110JE-TR](#) [3-1625875-1](#) [RC1/22R2JTD](#) [RC12JB3R30](#)
[CF18JT910R](#) [RC20GF240J](#) [RC20GF561J](#) [RC1/4435JB](#) [RC1/4135JB](#) [RC12JB15K0](#) [RC12JB82R0](#) [RC14JB12R0](#) [RC14JB180R](#)
[RC14JB330R](#) [RC1/4201JTD](#) [RC20GF470JTRLF](#) [RC1/2155KTD](#) [RC1/4274KTD](#) [RC1/47R5JB](#) [RC1/4565JB](#) [RC1/4160JB](#) [RC1/2475KTB](#)
[RC1/2431JTD](#) [RC1/2166KTD](#) [RC1/2102JTD](#) [RC1/2434JB](#) [RC1/22R4JB](#) [RC07GF510JTR](#) [RCC025 2R7 J B](#) [CBT50J6K8](#) [OA182KE](#)
[OA682KE](#) [OD130JE](#) [OD222J](#) [OF106KE](#) [CBT25J680K](#) [CBT25J68K](#) [CBT25J6R8](#) [CBT50J1M5](#) [CBT50J1R0](#) [CBT50J27R](#) [CBT50J330K](#)
[CBT50J47R](#) [CBT50J6M8](#)