



Chip Resistors (RM series standard) Halogen-Free

| | |
|--------------|--------------|
| Document No. | TRM-XX0S010E |
| Revise Date | 2017/02/22 |
| page number | 1/13 |

1. Scope :

This specification applies for the RM series of chip resistors made by TA-I.

2. Construction :



3. Type Designation :

| | | | | |
|--------------------|------------------|-----------------|------------------|--------------------|
| <u>RM</u> | <u>10</u> | <u>J</u> | <u>TN</u> | <u>103</u> |
| Product Code | Size | Tolerance | Packaging | Nominal Resistance |
| RM : Chip Resistor | Power Rating | | | |

| | | | |
|--|---|---|--|
| 01-01005(0402) 1/32W 02-0201(0603) 1/20W 04-0402(1005) 1/16W 06-0603(1608) 1/10W 10-0805(2012) 1/8W 12-1206(3216) 1/4W 13-1210(3226) 1/3W 20-2010(5025) 3/4W 25-2512(6432) 1 W | J-±5% G-±2% F-±1% D-±0.5% B-±0.1% | T- Paper Tape E- Embossed Tape <hr/> N : normal (RoHS Exclusion clause) W : Totally Lead free | 3 digits, e.g.,: (E-24) 103 = 10kΩ 0 = 0Ω 4 digits, e.g., : (E-96) 1540 = 154Ω 43R2 = 43.2Ω |
|--|---|---|--|



**Chip Resistors
(RM series standard)
Halogen-Free**

Document No. TRM-XX0S010E

Revise Date 2017/02/22

page number 2/13

4. Dimensions :

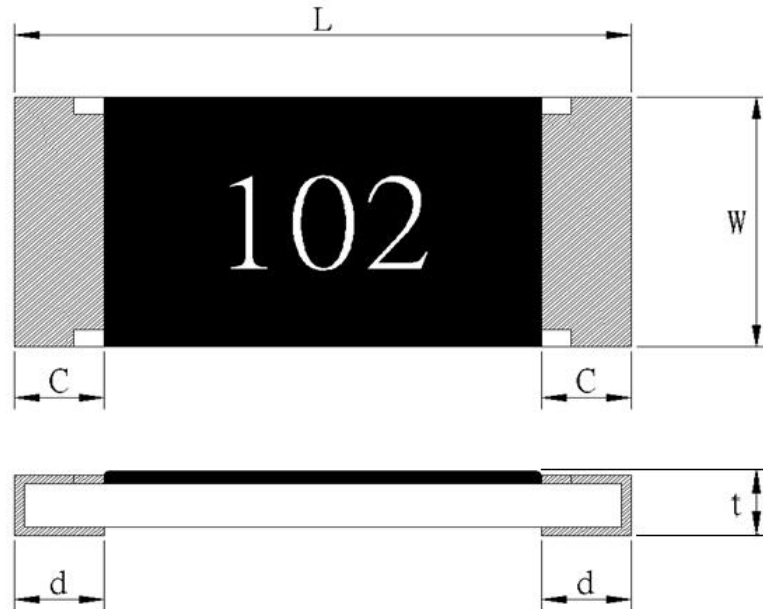

UNIT: mm

| Type | L | W | C | d | t |
|------|---|-----------|-----------|--|------------|
| RM01 | 0.4 ±0.02 | 0.2 ±0.02 | 0.1 ±0.03 | 0.1±0.03 | 0.13 ±0.02 |
| RM02 | 0.60±0.03 | 0.30±0.03 | 0.1±0.05 | 0.15±0.05 | 0.23±0.03 |
| RM04 | ^{+0.1} 1.00 _{-0.05} | 0.50±0.05 | 0.20±0.10 | 0.25±0.10 | 0.32±0.05 |
| RM06 | 1.60±0.10 | 0.80±0.10 | 0.30±0.20 | ^{+0.2} 0.30 _{-0.1} | 0.45±0.10 |
| RM10 | 2.00±0.10 | 1.25±0.10 | 0.40±0.20 | 0.40±0.20 | 0.50±0.10 |
| RM12 | 3.10±0.10 | 1.55±0.10 | 0.50±0.30 | 0.40±0.20 | 0.55±0.10 |
| RM13 | 3.10±0.10 | 2.55±0.10 | 0.50±0.30 | 0.40±0.20 | 0.60±0.10 |
| RM20 | 5.00±0.15 | 2.50±0.15 | 0.60±0.30 | 0.50±0.25 | 0.60±0.10 |
| RM25 | 6.30±0.20 | 3.20±0.20 | 0.60±0.30 | 0.50±0.25 | 0.60±0.10 |



Chip Resistors (RM series standard) Halogen-Free

| | |
|--------------|--------------|
| Document No. | TRM-XX0S010E |
| Revise Date | 2017/02/22 |
| page number | 3/13 |

5. Ratings & Characteristics :

| Type | Power Rating at 70°C | Rating Voltage | Max. Working Voltage | Max. Over-Load Voltage | T.C.R (PPM/°C) | Resistance Range(Ω) | | | | |
|------|----------------------|----------------|----------------------|------------------------|----------------|-----------------------|-----------------------|----------------------------------|-----------------|----------------------------|
| | | | | | | B(±0.1%) E-96&E-24 | D(±0.5%) E-96&E-24 | F(±1%) E-96&E-24 | G(±2%) E-24 | J(±5%) E-24 |
| RM01 | 1/32W | Refer 5.2 | 15V | 30V | ±300 | | | 10Ω ≤ R < 100Ω | 10Ω ≤ R < 100Ω | 10Ω ≤ R < 100Ω |
| | | | | | ±200 | | | 100Ω ≤ R ≤ 1MΩ | 100Ω ≤ R ≤ 1MΩ | 100Ω ≤ R ≤ 1MΩ |
| RM02 | 1/20W | Refer 5.2 | 25V | 50V | ±200 | 100Ω-10KΩ | | 10Ω-3MΩ | 10Ω-3MΩ | 10Ω-10MΩ |
| | | | | | +600 -200 | | | 1-9.1Ω | 1-9.1Ω | 1-9.1Ω |
| RM04 | 1/16W | Refer 5.2 | 50V | 100V | ±100 | 100Ω-499KΩ | 100Ω-1MΩ | 100Ω-1MΩ | | |
| | | | | | ±200 | 10Ω ≤ R < 100Ω | 10Ω ≤ R < 100Ω | 10Ω ≤ R < 100Ω 1MΩ < R ≤ 10MΩ | 10Ω-10MΩ | 10Ω-10MΩ |
| | | | | | +500 -200 | | | 1Ω-9.1Ω | 1Ω-9.1Ω | 1Ω-9.1Ω |
| | | | | | ±400 | | | | 10MΩ ≤ R ≤ 20MΩ | 10MΩ ≤ R ≤ 20MΩ |
| RM06 | 1/10W | Refer 5.2 | 75V | 150V | ±100 | 10Ω-560kΩ | 10Ω-1MΩ | 10Ω-1MΩ | | |
| | | | | | ±200 | | | 1M < R ≤ 10MΩ | 10Ω-10MΩ | 10Ω-10MΩ |
| | | | | | ±400 | | | 1Ω-9.1Ω | 1Ω-9.1Ω | 1Ω-9.1Ω 10MΩ < R ≤ 20MΩ |
| RM10 | 1/8W | Refer 5.2 | 150V | 300V | ±100 | 10Ω-560kΩ | 10Ω-1MΩ | 10Ω-1MΩ | | |
| | | | | | ±200 | | | 1M < R ≤ 10MΩ | 10Ω-10MΩ | 10Ω-10MΩ |
| | | | | | ±400 | | | 1Ω-9.1Ω | 1Ω-9.1Ω | 1Ω-9.1Ω 10MΩ < R ≤ 20MΩ |
| RM12 | 1/4W | Refer 5.2 | 200V | 400V | ±100 | 10Ω-560kΩ | 10Ω-1MΩ | 10Ω-1MΩ | | |
| | | | | | ±200 | | | 1M < R ≤ 10MΩ | 10Ω-10MΩ | 10Ω-10MΩ |
| | | | | | ±400 | | | 1Ω-9.1Ω | 1Ω-9.1Ω | 1Ω-9.1Ω 10MΩ < R ≤ 20MΩ |
| RM13 | 1/3W | Refer 5.2 | 200V | 400V | ±100 | 10Ω-560kΩ | 10Ω-1MΩ | 10Ω-1MΩ | | |
| | | | | | ±200 | | | 1M < R ≤ 10MΩ | 10Ω-10MΩ | 10Ω-10MΩ |
| | | | | | ±400 | | | 1Ω-9.1Ω | 1Ω-9.1Ω | 1Ω-9.1Ω 10MΩ < R ≤ 20MΩ |
| RM20 | 3/4W | Refer 5.2 | 200V | 400V | ±100 | 10Ω-560kΩ | 10Ω-1MΩ | 10Ω-1MΩ | | |
| | | | | | ±200 | | | 1M < R ≤ 10MΩ | 10Ω-10MΩ | 10Ω-10MΩ |
| | | | | | ±400 | | | 1Ω-9.1Ω | 1Ω-9.1Ω | 1Ω-9.1Ω 10M < R ≤ 20MΩ |
| RM25 | 1W | Refer 5.2 | 200V | 400V | ±100 | 10Ω-560kΩ | 10Ω-1MΩ | 10Ω-1MΩ | | |
| | | | | | ±200 | | | 1M < R ≤ 10MΩ | 10Ω-10MΩ | 10Ω-10MΩ |
| | | | | | ±400 | | | 1Ω-9.1Ω | 1Ω-9.1Ω | 1Ω-9.1Ω 10M < R ≤ 20MΩ |

Ω THICK FILM CHIP RESISTORS

| Type | Rated Current | Max Overload Current | Resistance Range |
|------|---------------|----------------------|------------------|
| RM01 | 0.5A | 1A | 50mΩ MAX |
| RM02 | 0.5A | 1A | 50mΩ MAX |
| RM04 | 1A | 2.5A | 50mΩ MAX |
| RM06 | 1A | 2.5A | 50mΩ MAX |
| RM10 | 2A | 5A | 50mΩ MAX |
| RM12 | 2A | 5A | 50mΩ MAX |
| RM13 | 2A | 5A | 50mΩ MAX |
| RM20 | 2A | 5A | 50mΩ MAX |
| RM25 | 2A | 5A | 50mΩ MAX |

Operating Temp (°C) : -55°C ~ +155°C (RM01 / 02 : -55°C ~ +125°C)

Note : Except for the above standardized products, we also provide the customized products.



Chip Resistors (RM series standard) Halogen-Free

Document No. TRM-XX0S010E

Revise Date 2017/02/22

page number 4/13

5.1 Resistance Material (Totally Lead free RM04/06/10/12)

| Resistance Range (Ω) | Resistive Element |
|----------------------|-------------------|
| 1Ω~100Ω | Alloy Film |
| >100Ω | Thick Film |

5.2 Derating Curve :

For resistors operated at ambient temperature over 70°C , power rating shall be derated in accordance with figure 1.

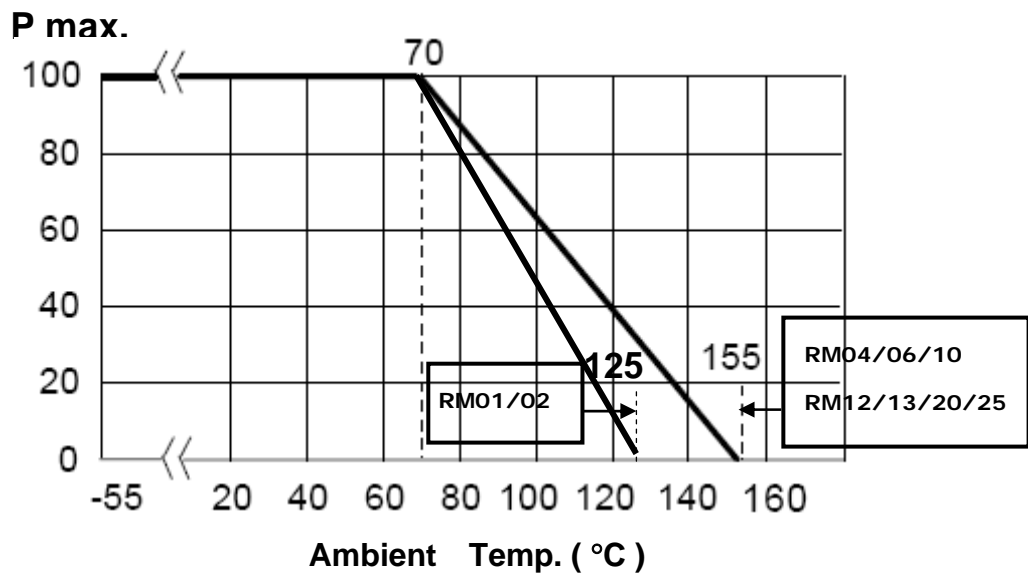

Figure 1

5.3 Rated Voltage :

The rated voltage is calculated by the following formula:

$$E = \sqrt{P * R}$$

E=Rated Voltage(V)
 P=Rated Power(W)
 R=Resistance Value(Ω)

E.G. : What is RM06JTN102 the rated voltage ?

RM06JTN102 P:1/10W ; R:102 = 1KΩ = 1000Ω

$$E = \sqrt{0.1(W) * 1000(\Omega)} = 10 (V)$$



Chip Resistors (RM series standard) Halogen-Free

Document No. TRM-XX0S010E

Revise Date 2017/02/22

page number 5/13

6. Reliability Tests :

| Test Items | Reference standard | Condition of Test | Test Limits ΔR |
|---|---|---|--|
| Temperature Coefficient of Resistance | IEC60115-1-4.8 JIS-C5201-1-4.8 | -55~ +125 °C | Refer 5.0 |
| Short Time Overload | IEC60115-1-4.13 JIS-C5201-1-4.13 | 2.5 X rated voltage for 5 sec | $\pm(1\% + 0.05\Omega)$ Remarks : 01005& 0201 : $\pm(3\% + 0.1\Omega)$ 0402 : $\pm(2\% + 0.1\Omega)$ 0Ω : 50mΩ or less |
| Intermittent Overload | IEC60115-1-4.39 JIS-C5201-1-4.39 | 3.0 X rated voltage or Max Overloading voltage ,1sec "ON" , 25sec "OFF" , 10000 cycles (Remarks : 01005 & 0201-NA , 0402 2.5 X RCWV *) | $\pm (5.0\% + 0.1\Omega)$ 0Ω : 50mΩ or less |
| Endurance (Load Life) | IEC60115-1-4.25.1 JIS-C5201-1-4.25.1 | 1000 hours at rated voltage, 70°C , 1.5hours "ON" , 0.5hour "OFF" | 0.1%,0.5%,1%: $\pm(1.0\%+0.05\Omega)$ 2%,5%: $\pm(3.0\%+0.1\Omega)$ Remarks : 01005& 0201 : $\pm(5.0\%+0.1\Omega)$ 0402 : $\pm(3.0\%+0.1\Omega)$ 0Ω : 100mΩ or less |
| Load Life with Humidity | IEC60115-1-4.24 JIS-C5201-1-4.24 | 1000 hours at rated voltage , 40±2°C , 90~95% RH 1.5hours "ON" , 0.5hour "OFF" | 0.1%,0.5%,1%: $\pm(1.0\%+0.05\Omega)$ 2% , 5%: $\pm(3.0\%+0.1\Omega)$ Remarks : 01005&0201: $\pm(5.0\%+0.1\Omega)$ 0402: $\pm(3.0\%+0.1\Omega)$ 0Ω : 100mΩ or less |
| Rapid Change of Temperature | IEC60115-1-4.19 JIS-C5201-1-4.19 | -55°C (30 min.) / +155 °C(30 min.) 5 cycles | 0.1%,0.5%,1%: $\pm(0.5\%+0.05\Omega)$ 2% , 5%: $\pm(1.0\%+0.05\Omega)$ Remarks : 01005& 0201: $\pm(3.0\%+0.1\Omega)$ 0Ω : 50mΩ or less |
| Solderability | IEC60115-1-4.17 JIS-C5201-1-4.17 | 245±5°C solder, 2±0.5 sec dwell. Solder : Sn96.5 / Ag3.0 / Cu0.5 | At least 95% of surface area of electrode shall be covered with new solder. |
| Robustness of Termination (Bending) | IEC60115-1-4.33 JIS-C5201-1-4.33 | 3mm deflection 2mm deflection (RM20,25) | 0.1%,0.5%,1%: $\pm(0.5\%+0.05\Omega)$ 2%,5%: $\pm(1.0\%+0.05\Omega)$ Remarks : 01005& 0201 $\pm(1.0\%+0.1\Omega)$ 0Ω : 50mΩ or less |
| Dielectric Withstanding Voltage (Voltage Proof) | IEC60115-1-4.7 JIS-C5201-1-4.7 | Applying voltage : 01005 & 0201 : 50V , 0402 & 0603 : 300V The other 500V for a minute . | No abnormalities such as flashover, burning dielectric breakdown shall appear. |
| Insulation Resistance | IEC60115-1-4.6 JIS-C5201-1-4.6 | Applying voltage 100V for 1 minute. Remark : 01005 & 0201 50V | $\geq 1G\Omega$ Remarks : 01005 : $\geq 100M\Omega$ |
| Resistance to Dry Heat | IEC60115-1-4.23.2 JIS-C5201-1-4.23.2 | 155±5°C for 96±4Hrs Remark : 01005 & 0201 125±5°C | 0.1%,0.5%,1%: $\pm(1.0\%+0.05\Omega)$ 2%,5%: $\pm(2.0\%+0.1\Omega)$ Remark : 01005 : $\pm(3.0\%+0.1\Omega)$ 0201 : $\pm(2.0\%+0.1\Omega)$ 0Ω : 50mΩ or less |
| Resistance to Solder Heat | IEC60115-1-4.18 JIS-C5201-1-4.18 | 270 ±5°C solder , 10 ±1 sec dwell . | 0.1%,0.5%,1%: $\pm(0.5\%+0.05\Omega)$ 2% , 5%: $\pm(1.0\%+0.05\Omega)$ Remarks : 01005 : $\pm(3.0\%+0.05\Omega)$ 0201 $\pm(3.0\%+0.1\Omega)$ 0Ω : 50mΩ or less |

Note* : RCWV : Rated continuous working voltage .



**Chip Resistors
(RM series standard)
Halogen-Free**

| | |
|--------------|--------------|
| Document No. | TRM-XX0S010E |
| Revise Date | 2017/02/22 |
| page number | 6/13 |

7. Marking

7.1 ±2% & ±5%(E24) : RM06 / RM10 / RM12 / RM13 / RM20 / RM25

Resistance value is expressed by 3 digits, the first two digits represent the significant figures of nominal resistance value in Ω , and the third digit represents exponent for base of 10.

E.G. :, 102 = $10 \times 10^2 = 1000 \Omega = 1K \Omega$



Notes :

RM06 : R represents the 「 · 」

7.2 ±0.1% , ±0.5% , ±1% (E96) : RM10 / RM12 / RM13 / RM20 / RM25

Resistance value is expressed by 4 digits , the first three digits represent the significant figures of nominal resistance value in Ω , and the fourth digit represents exponent for base of 10.

E.G. : 1000 = $100 \times 10^0 = 100 \Omega$



7.3 ±0.1% , ±0.5% , ±1% (E96): RM06

When the marking space is too small in such small-sized resistors as RM06, the marking can not made by 4 digits and may be made by two digits combined with one English capital.

Symbol for E96 series nominal resistance value

| Symbol | E96 | Symbol | E96 | Symbol | E96 | Symbol | E96 |
|--------|-----|--------|-----|--------|-----|--------|-----|
| 01 | 100 | 25 | 178 | 49 | 316 | 73 | 562 |
| 02 | 102 | 26 | 182 | 50 | 324 | 74 | 576 |
| 03 | 105 | 27 | 187 | 51 | 332 | 75 | 590 |
| 04 | 107 | 28 | 191 | 52 | 340 | 76 | 604 |
| 05 | 110 | 29 | 196 | 53 | 348 | 77 | 619 |
| 06 | 113 | 30 | 200 | 54 | 357 | 78 | 634 |
| 07 | 115 | 31 | 205 | 55 | 365 | 79 | 649 |
| 08 | 118 | 32 | 210 | 56 | 374 | 80 | 665 |
| 09 | 121 | 33 | 215 | 57 | 383 | 81 | 681 |
| 10 | 124 | 34 | 221 | 58 | 392 | 82 | 698 |
| 11 | 127 | 35 | 226 | 59 | 402 | 83 | 715 |
| 12 | 130 | 36 | 232 | 60 | 412 | 84 | 732 |
| 13 | 133 | 37 | 237 | 61 | 422 | 85 | 750 |
| 14 | 137 | 38 | 243 | 62 | 432 | 86 | 768 |
| 15 | 140 | 39 | 249 | 63 | 442 | 87 | 787 |
| 16 | 143 | 40 | 255 | 64 | 453 | 88 | 806 |
| 17 | 147 | 41 | 261 | 65 | 464 | 89 | 825 |
| 18 | 150 | 42 | 267 | 66 | 475 | 90 | 845 |
| 19 | 154 | 43 | 274 | 67 | 487 | 91 | 866 |



**Chip Resistors
(RM series standard)
Halogen-Free**

Document No. TRM-XX0S010E

Revise Date 2017/02/22

page number 7/13

| | | | | | | | |
|----|-----|----|-----|----|-----|----|-----|
| 20 | 158 | 44 | 280 | 68 | 499 | 92 | 887 |
| 21 | 162 | 45 | 287 | 69 | 511 | 93 | 909 |
| 22 | 165 | 46 | 294 | 70 | 523 | 94 | 931 |
| 23 | 169 | 47 | 301 | 71 | 536 | 95 | 953 |
| 24 | 174 | 48 | 309 | 72 | 549 | 96 | 976 |

Symbol for multipliers

| Symbol | A | B | C | D | E | F | G | H | X | Y | Z |
|-------------|-----------------|-----------------|-----------------|-----------------|-----------------|-----------------|-----------------|-----------------|------------------|------------------|------------------|
| multipliers | 10 ⁰ | 10 ¹ | 10 ² | 10 ³ | 10 ⁴ | 10 ⁵ | 10 ⁶ | 10 ⁷ | 10 ⁻¹ | 10 ⁻² | 10 ⁻³ |

E.G : 01A = 100×10⁰ = 100Ω



Notes :

When the resistance value is not in the list of E96 , 3 digitals with underline in E-24 series is used as mark .

E.G. : 0603 , 120Ω , 1% Marking is 121



7.4 ±0.1% , ±0.5% , ±1%(E96/3digitals)

The resistance value by 3 digits is requirement for customer.

7.5 RM06 / RM10 / RM12 / RM13 / RM20 / RM25

E.G. : 0 = 0Ω



7.5 No Marking for RM01 & RM02 & RM04



Chip Resistors (RM series standard) Halogen-Free

| | |
|--------------|--------------|
| Document No. | TRM-XX0S010E |
| Revise Date | 2017/02/22 |
| page number | 8/13 |

8. Taping & Reel :

8.1 Taping Dimensions

8.1.1 4 mm pitch paper :



| Packing | Type | A | B | W | F | E | P ₁ | P ₂ | P ₀ | D ₀ | T |
|---------|------|----------|---------|---------|----------|----------|----------------|----------------|----------------|---------------------|----------|
| Paper | RM06 | 1.1±0.1 | 1.9±0.1 | 8.0±0.2 | 3.5±0.05 | 1.75±0.1 | 4.0±0.1 | 2.0±0.05 | 4.0±0.1 | φ 1.5 +0.1 -0 | 0.64±0.1 |
| | RM10 | 1.6±0.15 | 2.4±0.2 | | | | | | | | 0.84±0.1 |
| | RM12 | 2.0±0.15 | 3.6±0.2 | | | | | | | | |
| | RM13 | 2.8±0.2 | 3.6±0.2 | | | | | | | | |

8.1.2 2 mm pitch paper :



| Packing | Type | A | B | W | F | E | P ₁ | P ₂ | P ₀ | D ₀ | T |
|---------|------|-----------|----------|---------|----------|----------|----------------|----------------|----------------|---------------------|----------|
| Paper | RM01 | 0.24±0.05 | 0.45±0.1 | 8.0±0.2 | 3.5±0.05 | 1.75±0.1 | 2.0±0.1 | 2.0±0.05 | 4.0±0.1 | φ 1.5 +0.1 -0 | 0.40±0.1 |
| | RM02 | 0.37±0.05 | 0.67±0.1 | | | | 2.0±0.1 | 2.0±0.05 | | | 0.37±0.1 |
| | RM04 | 0.7±0.05 | 1.2±0.05 | | | | 2.0±0.1 | 2.0±0.1 | | | 0.45±0.1 |
| | RM06 | 1.1±0.1 | 1.9±0.1 | | | | 2.0±0.1 | 2.0±0.1 | | | 0.64±0.1 |



Chip Resistors (RM series standard) Halogen-Free

Document No. TRM-XX0S010E

Revise Date 2017/02/22

page number 9/13

8.1.3 4 mm pitch Emboss :

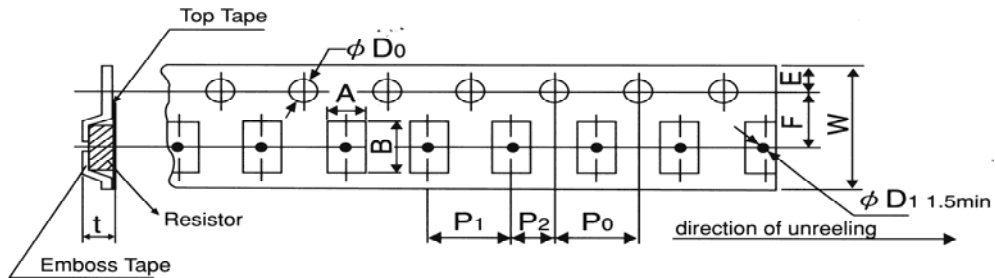

| Packing | Type | A | B | W | F | E | P ₁ | P ₂ | P ₀ | D ₀ | T |
|---------|------|---------|---------|----------|----------|----------|----------------|----------------|----------------|----------------|-----------|
| Emboss | RM20 | 2.8±0.2 | 5.3±0.2 | 12.0±0.2 | 5.5±0.05 | 1.75±0.1 | 4.0±0.1 | 2.0±0.05 | 4.0±0.05 | φ 1.5 | 0.85±0.15 |
| | RM25 | 3.6±0.2 | 6.9±0.2 | | | | | | | | |

UNIT: mm

| Package Type / Size | | Paper Tape | | | | Emboss Plastic Tape 4 mm pitch |
|------------------------|----|------------|---------|------------|---------|-----------------------------------|
| | | 4 mm pitch | | 2 mm pitch | | |
| | | 178mm/R | 250mm/R | 178mm/R | 250mm/R | |
| RM | 01 | | | 10000 | | |
| RM | 02 | | | 10000 | | |
| RM | 04 | | | 10000 | 20000 | |
| RM | 06 | 5000 | 10000 | 10000 | 20000 | |
| RM | 10 | 5000 | 10000 | | | |
| RM | 12 | 5000 | 10000 | | | |
| RM | 13 | 5000 | | | | |
| RM | 20 | | | | | 4000 |
| RM | 25 | | | | | 4000 |



**Chip Resistors
(RM series standard)
Halogen-Free**

Document No. TRM-XX0S010E

Revise Date 2017/02/22

page number 10/13

8.2 Reel Specifications:

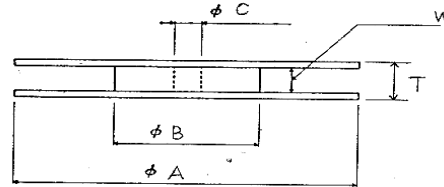
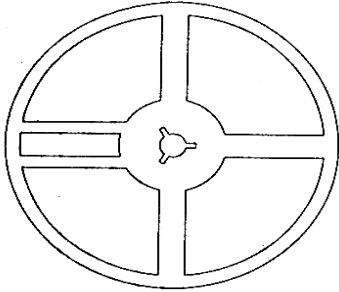

UNIT: mm

| Type | φ A | φ B | φ C | W | T |
|---------------------------------------|-------------|------------|------------|------------|------------|
| RM01 / 02 / 04 / 06 RM10 / 12 / 13 | 178.0 ± 2.0 | 60.0 ± 1.0 | 13.0 ± 1.0 | 9.0 ± 1.0 | 11.5 ± 1.0 |
| RM20 / 25 | | | | 13.0 ± 1.0 | 15.5 ± 1.0 |

8.3. Peel –off force :

Peel –off force of paper and blister tape is in accordance with “JIS-C5202 ”
that is , 0.1 to 0.7 N at a peel-off speed of 300 mm / minute.

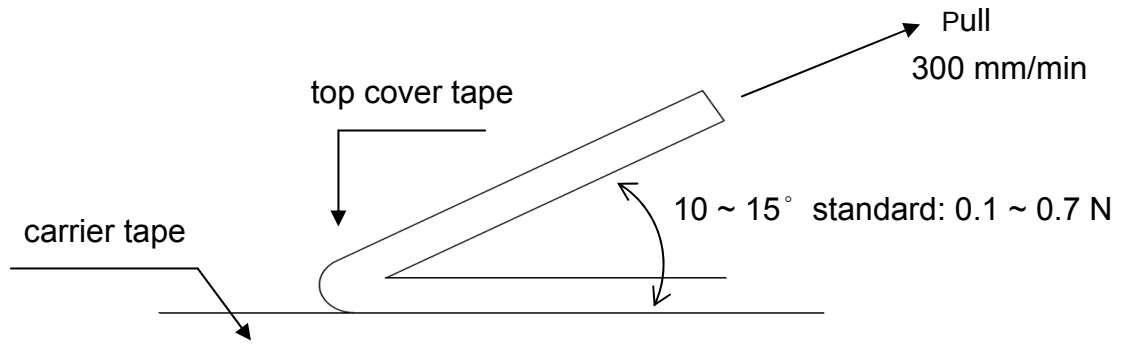

9. Label :

9.1 Manufacture Label : Normal (RoHS Exclusion clause)

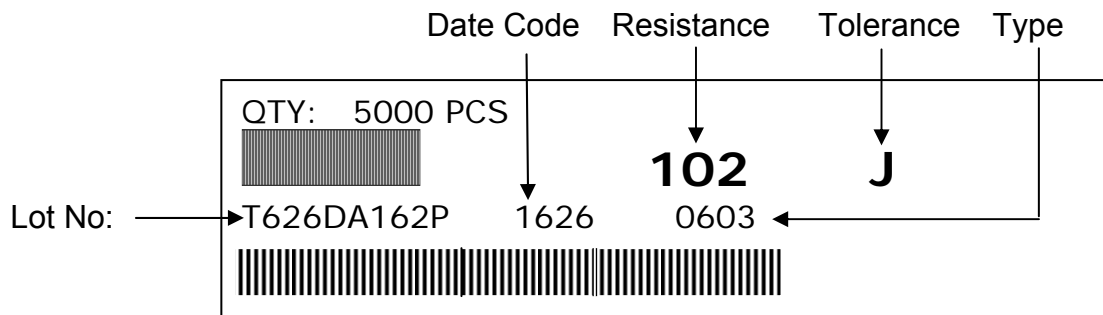



**Chip Resistors
(RM series standard)
Halogen-Free**

| | |
|--------------|--------------|
| Document No. | TRM-XX0S010E |
| Revise Date | 2017/02/22 |
| page number | 11/13 |

9.2 Manufacture Label : Totally Lead free



9.3 Customer Label (By customer request):



10. Recommended land patterns :



| Type | Size | Land pattern | | |
|------|-------------|------------------|---------|-----------|
| | | Dimension (mm) | | |
| | | a | b | c |
| RM | 01 (01005) | 0.15~0.20 | 0.5~0.7 | 0.20~0.25 |
| RM | 02 (0201) | 0.25~0.3 | 0.7~0.9 | 0.3~0.4 |
| RM | 04 (0402) | 0.50~0.6 | 1.4~1.6 | 0.4~0.6 |
| RM | 06 (0603) | 0.7~0.9 | 2.0~2.2 | 0.8~1.0 |
| RM | 10 (0805) | 1.0~1.4 | 3.2~3.8 | 0.9~1.4 |
| RM | 12 (1206) | 2.0~2.4 | 4.4~5.0 | 1.2~1.8 |
| RM | 13 (1210) | 2.0~2.4 | 4.4~5.0 | 2.3~3.5 |
| RM | 20 (2010) | 3.3~3.7 | 5.7~6.5 | 2.3~3.5 |
| RM | 25 (2512) | 3.6~4.0 | 7.6~8.6 | 2.3~3.5 |



**Chip Resistors
(RM series standard)
Halogen-Free**

| | |
|--------------|--------------|
| Document No. | TRM-XX0S010E |
| Revise Date | 2017/02/22 |
| page number | 12/13 |

11. Recommend IR – Reflow profile : (solder : Sn96.5 / Ag3 / Cu0.5)



| Profile Feature | Lead (Pb)-Free Assembly |
|---|-----------------------------------|
| Average ramp-up rate (Tsmmax to Tp) | 3°C / second max. |
| Preheat - Temperature Min (Tsmmin) - Temperature Max (Tsmmax) - Time (Tsmmin to Tsmmax) (ts) | 150°C 200°C 60 -150 seconds |
| Time maintained above : - Temperature (TL) - Time (tL) | 217°C 60-120 seconds |
| Peak Temperature (Tp) | 260°C |
| Time within $\begin{matrix} +0 \\ -5 \end{matrix}$ °C of actual Peak Temperature (tp) ² | 10 seconds |
| Ramp-down Rate | 6°C/second max. |
| Time 25°C to Peak Temperature | 8mimutes max. |

Allowed Re-flow times : 3 times

Remark : To avoid discoloration phenomena of chip on terminal electrodes, please use N2 Re-flow furnace .



**Chip Resistors
(RM series standard)
Halogen-Free**

| | |
|--------------|--------------|
| Document No. | TRM-XX0S010E |
| Revise Date | 2017/02/22 |
| page number | 13/13 |

12. Storage Conditions:

Temperature: 5°C~35°C ,Humidity:40%~75%

13. Shelf Life:

2 years from manufacturing date.

14. ECN :

Engineering Change Notice: The customer will be informed with ECN if there is significant modification on the characteristics and materials described in Approval Sheet.

15. Manufacturing Country & City :

TA-I TECHNOLOGY CO., LTD. (Taiwan– Tao Yuan)
Tel: 886-3-3246169 Fax : 886-3-3246167

TA-I TECHNOLOGY (SU ZHOU) CO., LTD. (China – Su Zhou)
Tel :86- 512-63457879 Fax : 86-512-63457869

Associated companies :

(1) FORTUNE TASK RESISTOR FACTORY (China – Dongguan)
Tel : 86-769-8339-4790~3 Fax : 86-769-8339-4794

(2) TA-I TECHNOLOGY ELECTRONIC (DONGGUAN) CO., LTD. (China –Dongguan)
Tel : 86-769-8339-4790~3 Fax : 86-769-8339-4794

(3) TAI OHM ELECTRONICS (M) SDN. BHD. (Malaysia – Penang)
Tel :604- 3900480 Fax : 604-3901481

(4) P.T.TAI ELECTRONICS Indonesia (Indonesia – Jakarta)
Tel :62-21-89830123 Fax : 62-21-89830703

X-ON Electronics

Largest Supplier of Electrical and Electronic Components

Click to view similar products for [Thick Film Resistors - SMD category](#):

Click to view products by [TA-I Tech manufacturer](#):

Other Similar products are found below :

[CR-05FL7--150R](#) [CR-05FL7--19K6](#) [CR-05FL7--243R](#) [CR-05FL7--40K2](#) [CR-05FL7--698K](#) [CR-12FP4--324R](#) [CR-12JP4--680R](#)
[M55342K06B1E78RS3](#) [M55342K06B6E19RWL](#) [M55342K06B6E81RS3](#) [M55342M05B200DRWB](#) [M55342M06B4K70MS3](#) [MC0603-511-](#)
[JTW](#) [742C083750JTR](#) [MCR01MZPF1202](#) [MCR01MZPF1601](#) [MCR01MZPF1800](#) [MCR01MZPF6201](#) [MCR01MZPF9102](#) [MCR01MZPJ113](#)
[MCR01MZPJ121](#) [MCR01MZPJ125](#) [MCR01MZPJ751](#) [MCR03EZHJ103](#) [MCR03EZPFX2004](#) [MCR03EZPJ270](#) [MCR03EZPJ821](#)
[MCR10EZPF1102](#) [MCR18EZPJ330](#) [RC0603F1473CS](#) [RC0603F150CS](#) [RC1005F1152CS](#) [RC1005F1182CS](#) [RC1005F1372CS](#)
[RC1005F183CS](#) [RC1005F1911CS](#) [RC1005F1912CS](#) [RC1005F203CS](#) [RC1005F2052CS](#) [RC1005F241CS](#) [RC1005F2431CS](#)
[RC1005F3011CS](#) [RC1005F303CS](#) [RC1005F4321CS](#) [RC1005F4642CS](#) [RC1005F471CS](#) [RC1005F4751CS](#) [RC1005F5621CS](#)
[RC1005F6041CS](#) [RC1005J106CS](#)