

Specification for Approval

Date: 2021/08/17

Customer : 天诚科技

TAI-TECH P/N: SWF2012CF-SERIES

CUSTOMER P/N:

DESCRIPTION:

QUANTITY:

REMARK:	
Customer Approval Feedback	

西北臺慶科技股份有限公司
TAI-TECH Advanced Electronics Co., Ltd

代理商:

- 深圳市天诚科技有限公司
 Shenzhen TsaSun Technology Co., Ltd.
 Room 209, 2/F, Block A, Tengfei Industrial Building, No.6,
 Taohua Road, Futian District, Shenzhen
 TEL: 0755-8335 8885 / 0755-8335 9885
 E-mail: sales@tsasun.com
 www.tsacoil.com

- 西北臺慶科技股份有限公司
 TAI-TECH Advanced Electronics Co., Ltd
Headquarter:
 NO.1 YOU 4TH ROAD, YOUTH INDUSTRIAL DISTRICT, YANG-MEI,
 TAO-YUAN HSIEN, TAIWAN, R.O.C.
 TEL: +886-3-4641148 FAX: +886-3-4643565
 http://www.tai-tech.com.tw
 E-mail: sales@tai-tech.com.tw

- 臺慶精密電子(昆山)有限公司
 TAI-TECH ADVANCED ELECTRONICS(KUNSHAN) CO., LTD
 SHINWHA ROAD, KUNJIA HI-TECH INDUSTRIAL PARK, KUN-SHAN,
 JIANG-SU, CHINA
 TEL: +86-512-57619396 FAX: +86-512-57619688
 E-mail: hui@tai-tech.com.tw

Sales Dep.

APPROVED	CHECKED
夏曉曼	夏曉曼

R&D Center

APPROVED	CHECKED	DRAWN
羅宜春	梁周虎	卜文娟

Winding Type Chip Inductor

SWF2012CF-SERIES

1. Features

1. Ferrite core wire wound construction.
2. High Reliability due to wire wound type construction.
3. Small footprint as well as low profile.
4. Application for DC power line.
5. 100% Lead(Pb) & Halogen-Free and RoHS compliant.



2. Dimensions

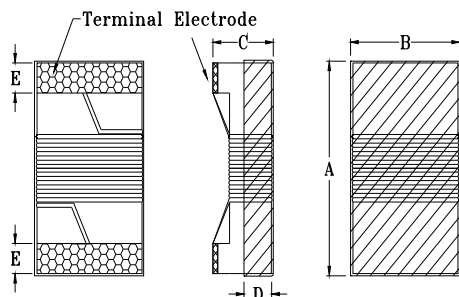

Size	A	B	C	D	E
SWF2012	2.40 max.	1.60 max.	1.40 max.	0.51 ref.	0.44±0.1

Unit:mm

3. Part Numbering



A: Series

B: Dimension

C: Application

D: Lead free type

E: Inductance

F: Inductance Tolerance

L x W

DC Power Line

R47=0.47 uH

K=±10%,M=±20%

4. Specification

TAI-TECH Part Number	Inductance (uH)	Tolerance	Test Frequency (Hz)	Q min.	Test Frequency (MHz)	Rated Current (mA) max.	DCR (Ω) max.	SRF (MHz) min.
SWF2012CF-R47□	0.47	K,M	0.5V/7.96M	10	7.96	750	0.20	720
SWF2012CF-R56□	0.56	K,M	0.5V/7.96M	10	7.96	730	0.21	665
SWF2012CF-R68□	0.68	K,M	0.5V/7.96M	10	7.96	670	0.28	565
SWF2012CF-R82□	0.82	K,M	0.5V/7.96M	10	7.96	650	0.31	545
SWF2012CF-1R0□	1.00	K,M	0.5V/7.96M	10	7.96	615	0.34	525
SWF2012CF-1R2□	1.20	K,M	0.5V/7.96M	10	7.96	550	0.39	473
SWF2012CF-1R5□	1.50	K,M	0.5V/7.96M	10	7.96	520	0.45	300
SWF2012CF-1R8□	1.80	K,M	0.5V/7.96M	10	7.96	500	0.48	230
SWF2012CF-2R2□	2.20	K,M	0.5V/7.96M	10	7.96	420	0.67	215

TAI-TECH Part Number	Inductance (uH)	Tolerance	Test Frequency (Hz)	Q min.	Test Frequency (MHz)	Rated Current (mA) max.	DCR (Ω) max.	SRF (MHz) min.
SWF2012CF-2R7□	2.70	K,M	0.5V/7.96M	10	7.96	410	0.74	140
SWF2012CF-3R3□	3.30	K,M	0.5V/7.96M	10	7.96	385	0.81	95
SWF2012CF-3R9□	3.90	K,M	0.5V/7.96M	10	7.96	372	0.88	57
SWF2012CF-4R7□	4.70	K,M	0.5V/7.96M	10	7.96	345	0.99	51
SWF2012CF-5R6□	5.60	K,M	0.5V/7.96M	10	7.96	335	1.06	44
SWF2012CF-6R8□	6.80	K,M	0.5V/7.96M	10	7.96	315	1.21	39
SWF2012CF-8R2□	8.20	K,M	0.5V/7.96M	10	7.96	295	1.33	33
SWF2012CF-100□	10.0	K,M	0.5V/2.52M	10	2.52	260	1.79	30
SWF2012CF-120□	12.0	K,M	0.5V/2.52M	10	2.52	250	1.98	27
SWF2012CF-150□	15.0	K,M	0.5V/2.52M	10	2.52	215	2.68	22
SWF2012CF-180□	18.0	K,M	0.5V/2.52M	10	2.52	195	3.12	20
SWF2012CF-220□	22.0	K,M	0.5V/2.52M	10	2.52	180	3.48	18
SWF2012CF-270□	27.0	K,M	0.5V/2.52M	10	2.52	170	3.84	16
SWF2012CF-330□	33.0	K,M	0.5V/2.52M	10	2.52	145	4.34	15

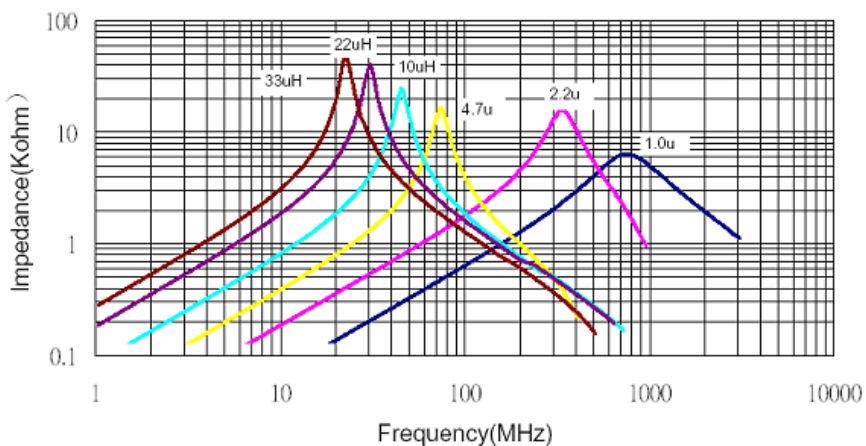
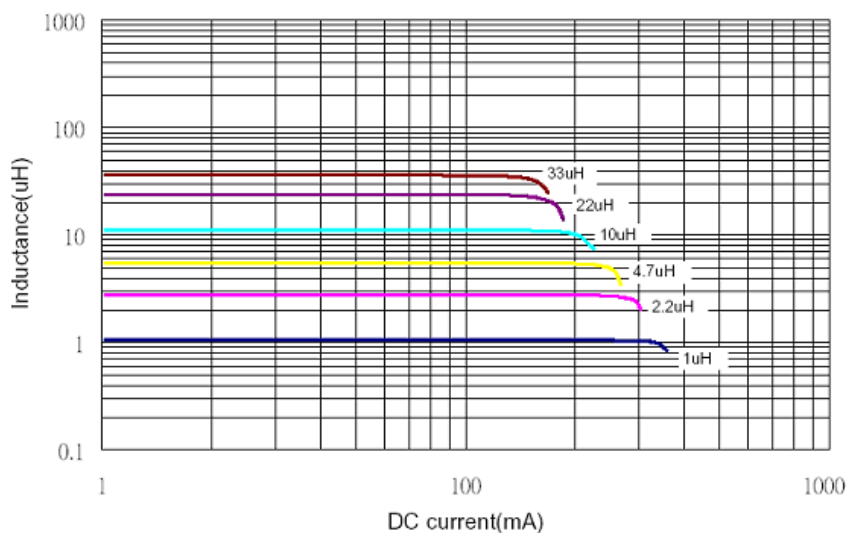

5. Materials

No.	Description	Specification
a.	Upper Plate	UV Glue
b.	Core	Ferrite Core
c.	Termination	Tin Pb Free
d.	Wire	Enameled Copper Wire

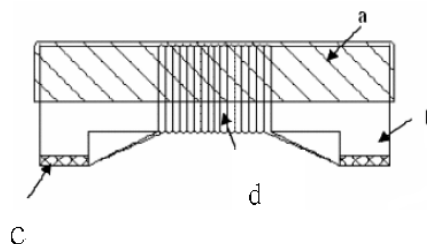

6. Reliability and Test Condition

Item	Performance	Test Condition
Operating temperature	-40~+125°C (Including self - temperature rise)	
Storage temperature	-40~+125°C (on board)	
Electrical Performance Test		
Inductance L	Refer to standard electrical characteristic list	Agilent-4291, Agilent-4287
Q		Agilent-4192, Agilent-4285
SRF		Agilent-4291
DC Resistance		Agilent-4338
Reliability Test		
Life Test		Preconditioning: Run through IR reflow for 2 times.(IPC/JEDEC J-STD-020DClassification Reflow Profiles) Temperature : 85±2°C Applied current : rated current Duration : 1000±12hrs Measured at room temperature after placing for 24±2 hrs
Load Humidity		Preconditioning: Run through IR reflow for 2 times.(IPC/JEDEC J-STD-020DClassification Reflow Profiles Humidity : 85±2% R.H, Temperature : 85°C ±2°C Duration : 1000hrs Min. with 100% rated current Measured at room temperature after placing for 24±2 hrs
Moisture Resistance	Appearance : No damage. Inductance : within±10% of initial value Q : Shall not exceed the specification value. RDC : within ±15% of initial value and shall not exceed the specification value	Preconditioning: Run through IR reflow for 2 times.(IPC/JEDEC J-STD-020DClassification Reflow Profiles 1. Baked at 50°C for 25hrs, measured at room temperature after placing for 4 hrs. 2. Raise temperature to 65±2°C 90-100%RH in 2.5hrs, and keep 3 hours, cool down to 25°C in 2.5hrs. 3. Raise temperature to 65±2°C 90-100%RH in 2.5hrs, and keep 3 hours, cool down to 25°C in 2.5hrs,keep at 25°C for 2 hrs then keep at -10°C for 3 hrs 4. Keep at 25°C 80-100%RH for 15min and vibrate at the frequency of 10 to 55 Hz to 10 Hz, measure at room temperature after placing for 1~2 hrs.
Thermal shock		Preconditioning: Run through IR reflow for 2 times.(IPC/JEDEC J-STD-020DClassification Reflow Profiles Condition for 1 cycle Step1 : -40±2°C 30±5min Step2 : 25±2°C ≤0.5min Step3 : 105±2°C 30±5min Number of cycles : 500 Measured at room temperature after placing for 24±2 hrs
Vibration		Oscillation Frequency: 10~2K~10Hz for 20 minutes Equipment : Vibration checker Total Amplitude:1.52mm±10% Testing Time : 12 hours(20 minutes, 12 cycles each of 3 orientations) °

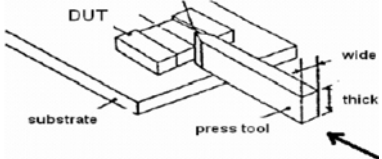
Item	Performance	Test Condition															
Shock	Appearance : No damage. Inductance : within±10% of initial value Q : Shall not exceed the specification value. RDC : within ±15% of initial value and shall not exceed the specification value	<table border="1"> <thead> <tr> <th>Type</th> <th>Peak value (g's)</th> <th>Normal duration (D) (ms)</th> <th>Wave form</th> <th>Velocity change (Vi)/ft/sec</th> </tr> </thead> <tbody> <tr> <td>SMD</td> <td>1500</td> <td>0.5</td> <td>Half-sine</td> <td>15.4</td> </tr> <tr> <td>Lead</td> <td>100</td> <td>6</td> <td>Half-sine</td> <td>12.3</td> </tr> </tbody> </table>	Type	Peak value (g's)	Normal duration (D) (ms)	Wave form	Velocity change (Vi)/ft/sec	SMD	1500	0.5	Half-sine	15.4	Lead	100	6	Half-sine	12.3
Type	Peak value (g's)	Normal duration (D) (ms)	Wave form	Velocity change (Vi)/ft/sec													
SMD	1500	0.5	Half-sine	15.4													
Lead	100	6	Half-sine	12.3													
Bending		Shall be mounted on a FR4 substrate of the following dimensions: >=0805:40x100x1.2mm <0805:40x100x0.8mm Bending depth: >=0805:1.2mm <0805:0.8mm duration of 10 sec.															
Solderability	More than 95% of the terminal electrode should be covered with solder °	Preheat: 150°C ,60sec. ° Solder: Sn96.5% Ag3% Cu0.5% Temperature: 245±5°C ° Flux for lead free: Rosin. 9.5% ° Dip time: 4±1sec ° Depth: completely cover the termination															
Resistance to Soldering Heat	Appearance : No damage. Inductance : within±10% of initial value Q : Shall not exceed the specification value. RDC : within ±15% of initial value and shall not exceed the specification value	Number of heat cycles: 1 <table border="1"> <thead> <tr> <th>Temperature (°C)</th> <th>Time(s)</th> <th>Temperature ramp/immersion and emersion rate</th> </tr> </thead> <tbody> <tr> <td>260 ±5(solder temp)</td> <td>10 ±1</td> <td>25mm/s ±6 mm/s</td> </tr> </tbody> </table>	Temperature (°C)	Time(s)	Temperature ramp/immersion and emersion rate	260 ±5(solder temp)	10 ±1	25mm/s ±6 mm/s									
Temperature (°C)	Time(s)	Temperature ramp/immersion and emersion rate															
260 ±5(solder temp)	10 ±1	25mm/s ±6 mm/s															
Terminal Strength		Preconditioning: Run through IR reflow for 2 times.(IPC/JEDEC J-STD-020DClassification Reflow Profiles With the component mounted on a PCB with the device to be tested, apply a force (>0805:1kg , <=0805:0.5kg)to the side of a device being tested. This force shall be applied for 60 +1 seconds. Also the force shall be applied gradually as not to apply a shock to the component being tested. 															

7. Soldering and Mounting

7-1. Recommended PC Board Pattern

Chip size							Land Patterns For Reflow Soldering		
Series	Type	A(mm)	B(mm)	C(mm)	D(mm)	E(mm)	L(mm)	G(mm)	H(mm)
SWF	2012	2.40max	1.60max	1.40max	0.51 ref.	0.44±0.1	2.80	1.20	1.78

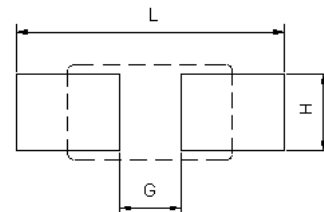

PC board should be designed so that products can prevent damage from mechanical stress when warping the board. Products shall be positioned in the sideways direction to against the mechanical stress to prevent failure.

7-2. Soldering

Mildly activated rosin fluxes are preferred. TAI-TECH terminations are suitable for all wave and re-flow soldering systems. If hand soldering cannot be avoided, the preferred technique is the utilization of hot air soldering tools.

7-2.1 Lead Free Solder re-flow:

Recommended temperature profiles for lead free re-flow soldering in Figure 1.

7-2.2 Soldering Iron(Figure 2):

Products attachment with a soldering iron is discouraged due to the inherent process control limitations. In the event that a soldering iron must be employed the following precautions are recommended.

- Preheat circuit and products to 150°C
- Never contact the ceramic with the iron tip
- Use a 20 watt soldering iron with tip diameter of 1.0mm
- 355°C tip temperature (max)
- 1.0mm tip diameter (max)
- Limit soldering time to 4-5 sec.

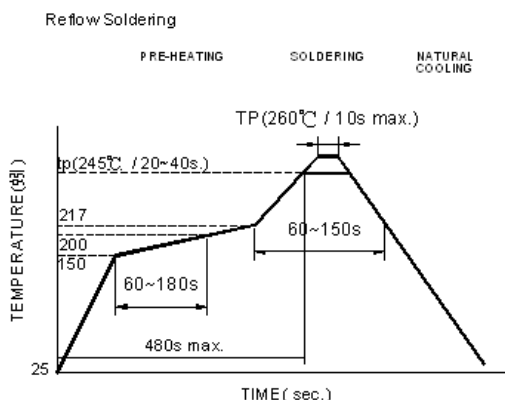

Reflow times: 3 times max.

Fig.1

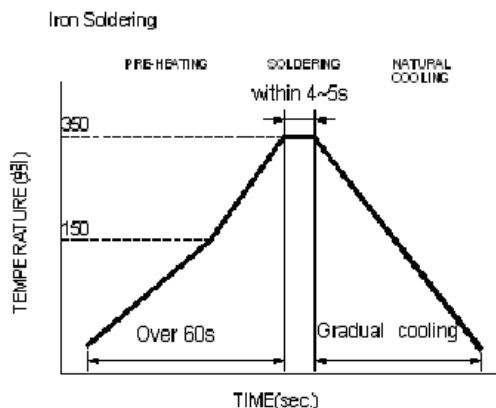

Iron Soldering times: 1 times max.

Fig.2

8. Packaging Information

8-1. Reel Dimension

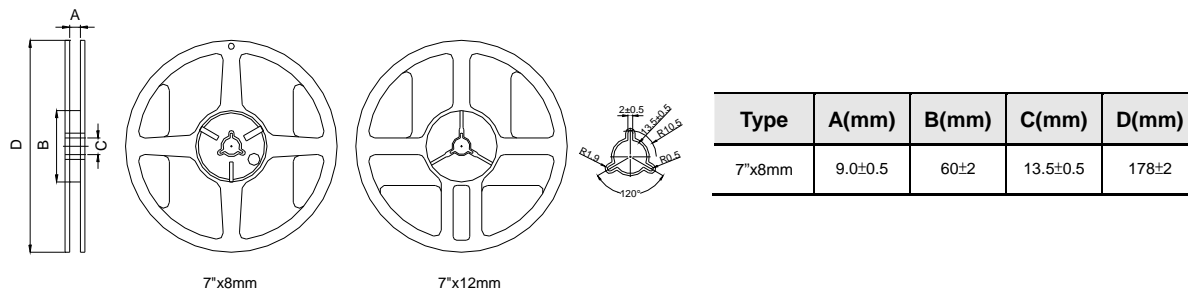

8-2. Tape Dimension / 8mm

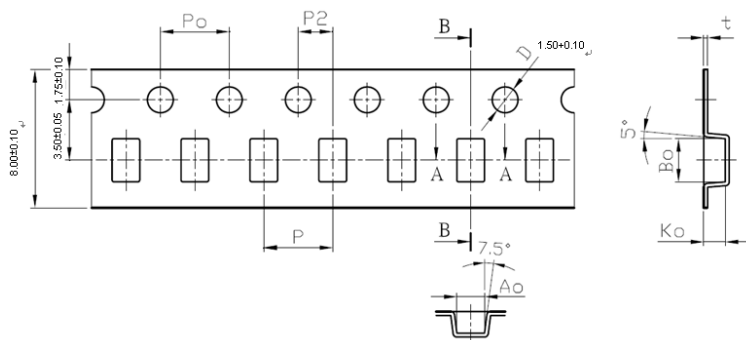

Series	P(mm)	Po(mm)	P2(mm)	Bo(mm)	Ao(mm)	Ko(mm)	W(mm)	t(mm)
SWF	4.00±0.10	4.00±0.10	2.00±0.05	2.50±0.10	1.60±0.10	1.25±0.10	8.00±0.10	0.22±0.05

8-3. Packaging Quantity

SWF	2012
Chip / Reel	2000
Reel Size	7"x8mm

8-4. Tearing Off Force

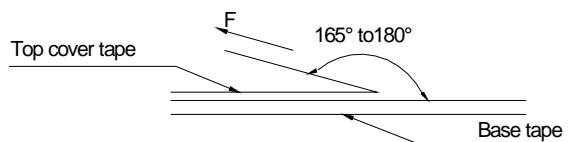

The force for tearing off cover tape is 15 to 80 grams in the arrow direction under the following conditions.

Room Temp. (°C)	Room Humidity (%)	Room atm (hPa)	Tearing Speed mm/min
5-35	45-85	860-1060	300

Application Notice

- Storage Conditions(component level)
 - To maintain the solderability of terminal electrodes:
 - 1.TAI-TECH products meet IPC/JEDEC J-STD-020D standard-MSL, level 1.
 2. Temperature and humidity conditions: Less than 40°C and 60% RH.
 3. Recommended products should be used within 12 months form the time of delivery.
 4. The packaging material should be kept where no chlorine or sulfur exists in the air.
- Transportation
 1. Products should be handled with care to avoid damage or contamination from perspiration and skin oils.
 2. The use of tweezers or vacuum pick up is strongly recommended for individual components.
 3. Bulk handling should ensure that abrasion and mechanical shock are minimized.

X-ON Electronics

Largest Supplier of Electrical and Electronic Components

Click to view similar products for [Fixed Inductors](#) category:

Click to view products by [Tai-Tech](#) manufacturer:

Other Similar products are found below :

[CR32NP-100KC](#) [70F224AI](#) [MHQ1005P10NJ](#) [MHQ1005P1N0S](#) [MHQ1005P2N4S](#) [MHQ1005P3N6S](#) [MHQ1005P5N1S](#) [MHQ1005P8N2J](#)
[PE-53601NL](#) [PE-53602NL](#) [PG0936.113NLT](#) [9220-20](#) [9310-16](#) [PM06-2N7](#) [PM06-39NJ](#) [A01TK](#) [1206CS-471XJ](#) [HC2-R47-R](#) [HC8-1R2-R](#)
[HCF1305-3R3-R](#) [1206CS-151XG](#) [RCH664NP-4R7M](#) [RCP1317NP-391L](#) [DH2280-4R7M](#) [DS1608C-106](#) [B10TJ](#) [B82498B3101J000](#) [ELJ-](#)
[RE27NJF2](#) [1812CS-153XJ](#) [1812CS-183XJ](#) [1812CS-223XJ](#) [1812LS-104XJ](#) [1812LS-105XJ](#) [1812LS-124XJ](#) [1812LS-154XJ](#) [1812LS-223XJ](#)
[1812LS-224XJ](#) [1812LS-563XJ](#) [1812LS-683XJ](#) [1812LS-824XJ](#) [NIN-FB101JTR110F](#) [NIN-FB471JTR62F](#) [NIN-FC1R5JTR220F](#) [NIN-](#)
[HCR15JTRF](#) [NIN-HCR33JTRF](#) [NIN-HDR22JTRF](#) [NIN-HDR82JTRF](#) [NIN-HK2N7STRF](#) [NIN-PA150KTR370F](#) [NIN-PB100KTR550F](#)