

**SMD Power Inductor**

TMPC0603HV-Series(G)-D

**ECN HISTORY LIST**

REV	DATE	DESCRIPTION	APPROVED	CHECKED	DRAWN
1.0	17/09/17	新發行	羅宜春	梁周虎	卜文娟
備注					

# SMD Power Inductor

TMPC0603HV-Series(G)-D

## 1. Features

1. Carbonyl Powder.
2. Compact design.
3. High current, low DCR, high efficiency.
4. Very low acoustic noise and very low leakage flux noise.
5. High reliability.
6. 100% Lead(Pb)-Free and RoHS compliant.
7. High reliability -Reliability test complied to AEC-Q200.
8. Operating temperature -55~+125°C(Including self - temperature rise)



## 2. Applications

Note PC power system, incl. IMVP-6  
DC/DC converter .

## 3. Dimensions

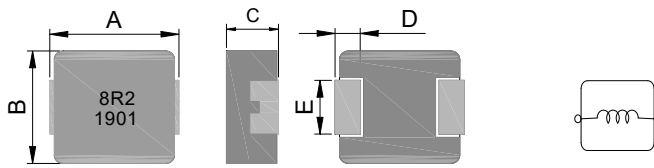

Series	A(mm)	B(mm)	C(mm)	D(mm)	E(mm)
TMPC0603HV	7.3±0.3	6.6±0.3	2.8±0.2	1.8±0.3	3.0±0.3

## Recommend PC Board Pattern

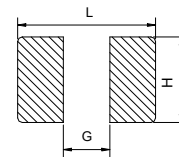

L(mm)	G(mm)	H(mm)
8.4	2.5	3.5

Note: 1. The above PCB layout reference only.  
2. Recommend solder paste thickness at 0.15mm and above.

## 4. Part Numbering

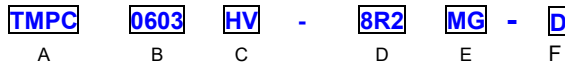

- A: Series
  - B: Dimension
  - C: Type
  - D: Inductance
  - E: Inductance Tolerance
  - F: Code
- BxC  
Carbonyl Powder, V:vehicle.  
8R2=8,20uH  
M=±20%  
Marking: Black.8R2 and 1901(19 YY, 01 WW, follow production date).

### 5. Specification

Part Number	Inductance L0 (uH)±20%	I rms ( A ) Typ	I sat ( A ) Typ	DCR (mΩ) Typ. @25°C	DCR (mΩ) Max. @25°C
TMPC0603HV-R10YG-D	0.10±30%	32.5	60.0	1.2	1.7
TMPC0603HV-R13YG-D	0.13±30%	27.6	50.0	1.3	1.8
TMPC0603HV-R15YG-D	0.15±30%	27.0	45.0	1.5	1.9
TMPC0603HV-R16YG-D	0.16±30%	27.0	45.0	1.5	1.9
TMPC0603HV-R18YG-D	0.18±30%	25.0	43.0	1.7	2.3
TMPC0603HV-R19YG-D	0.19±30%	24.0	41.0	1.8	2.5
TMPC0603HV-R20YG-D	0.20±30%	24.0	41.0	1.8	2.5
TMPC0603HV-R22YG-D	0.22±30%	23.0	40.0	2.1	2.8
TMPC0603HV-R25MG-D	0.25	21.0	39.0	3.3	3.5
TMPC0603HV-R30MG-D	0.30	21.0	35.0	3.2	3.8
TMPC0603HV-R33MG-D	0.33	20.0	32.0	3.5	3.9
TMPC0603HV-R36MG-D	0.36	19.0	32.0	3.6	4.2
TMPC0603HV-R40MG-D	0.40	18.0	27.5	3.71	4.1
TMPC0603HV-R47MG-D	0.47	17.5	26.0	4.0	4.2
TMPC0603HV-R56MG-D	0.56	16.5	25.5	4.7	5.0
TMPC0603HV-R60MG-D	0.60	16.0	25.5	4.7	5.2
TMPC0603HV-R68MG-D	0.68	15.5	25.0	4.8	5.5
TMPC0603HV-R75MG-D	0.75	14.5	24.5	5.5	6.6
TMPC0603HV-R82MG-D	0.82	13.0	24.0	6.7	8.0
TMPC0603HV-R90MG-D	0.90	11.0	22.0	8.3	10
TMPC0603HV-1R0MG-D	1.00	11.0	22.0	8.3	10
TMPC0603HV-1R2MG-D	1.20	10.0	20.0	10	12
TMPC0603HV-1R5MG-D	1.50	9.0	18.0	13	15
TMPC0603HV-1R8MG-D	1.80	8.5	16.0	14	17
TMPC0603HV-2R0MG-D	2.00	8.2	15.0	16	19
TMPC0603HV-2R2MG-D	2.20	8.0	14.0	18	20
TMPC0603HV-2R5MG-D	2.50	7.0	13.0	20	22
TMPC0603HV-2R7MG-D	2.70	7.0	13.0	24	27
TMPC0603HV-3R3MG-D	3.30	6.0	13.5	28	30
TMPC0603HV-4R7MG-D	4.70	5.5	10.0	37	40
TMPC0603HV-5R6MG-D	5.60	5.0	9.0	43	48
TMPC0603HV-6R8MG-D	6.80	4.5	8.0	54	60
TMPC0603HV-8R2MG-D	8.20	4.0	7.5	64	68
TMPC0603HV-100MG-D	10.0	3.5	6.0	75	85
TMPC0603HV-120MG-D	12.0	3.3	5.5	81	93
TMPC0603HV-150MG-D	15.0	3.0	4.0	107	123
TMPC0603HV-180MG-D	18.0	2.5	4.0	140	160
TMPC0603HV-220MG-D	22.0	2.0	3.5	165	190
TMPC0603HV-330MG-D	33.0	2.0	2.5	200	240
TMPC0603HV-470MG-D	47.0	1.75	2.0	302	363

Note:

1. Test frequency : Ls : 100KHz /1.0V.
2. All test data referenced to 25°C ambient.
3. Testing Instrument(or equ) : L: HP4284A,CH11025,CH3302,CH1320,CH1320S LCR METER / Rdc:CH16502,Agilent33420A MICRO OHMMETER.
4. Heat Rated Current (Irms) will cause the coil temperature rise approximately Δ T of 40°C
5. Saturation Current (Isat) will cause L0 to drop approximately30%.
6. The part temperature (ambient + temp rise) should not exceed 125°Cunder worst case operating conditions.Circuit design,component,PCB trace size and thickness,airflow and other cooling provisions all affect the part temperature. Part temperature should be verified in the end application.
7. Special inquiries besides the above common used types can be met on your requirement.

### 6. Material List

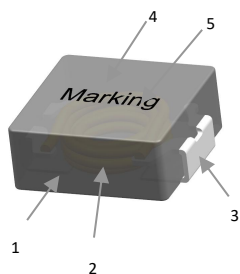

NO	Items	Materials
1	Core	Carbonyl Powder.
2	Wire	Polyester Wire or equivalent.
3	Clip	100% Pb free solder(Ni+Sn---Plating)
4	paint	Epoxy resin
5	Ink	Halogen-free ketone

### 7. Reliability and Test Condition

Item	Performance	Test Condition															
Operating temperature	-55~+125℃ (Including self - temperature rise)																
Storage temperature and Humidity range	1. -10~+40℃,50~60%RH (Product with taping) 2. -55~+125℃ (on board)																
<b>Electrical Performance Test</b>																	
Inductance	Refer to standard electrical characteristics list.	HP4284A,CH11025,CH3302,CH1320,CH1320S LCR Meter.															
DCR		CH16502,Agilent33420A Micro-Ohm Meter.															
Saturation Current (Isat)	Approximately $\Delta$ L30%	Saturation DC Current (Isat) will cause L0 to drop $\Delta$ L(%)															
Heat Rated Current (Irms)	Approximately $\Delta$ T40℃	Heat Rated Current (Irms) will cause the coil temperature rise $\Delta$ T(℃). 1.Applied the allowed DC current 2.Temperature measured by digital surface thermometer															
<b>Reliability Test</b>																	
High Temperature Exposure(Storage) AEC-Q200	Appearance: No damage. Impedance: within $\pm$ 15% of initial value Inductance: within $\pm$ 10% of initial value Q: Shall not exceed the specification value. RDC : within $\pm$ 15% of initial value and shall not exceed the specification value	Preconditioning: Run through IR reflow for 2 times.( IPC/JEDEC J-STD-020DClassification Reflow Profiles Temperature: 125 $\pm$ 2℃ (Inductor) Duration : 1000hrs Min. Measured at room temperature after placing for 24 $\pm$ 2 hrs															
Temperature Cycling AEC-Q200		Preconditioning: Run through IR reflow for 2 times.( IPC/JEDEC J-STD-020DClassification Reflow Profiles Condition for 1 cycle Step1: -55 $\pm$ 2℃ 30min Min.(Inductor) Step2: 125 $\pm$ 2℃ transition time 1min MAX. Step3: 125 $\pm$ 2℃ 30min Min. Step4: Low temp. transition time 1min MAX. Number of cycles: 1000 Measured at room temperature after placing for 24 $\pm$ 2 hrs															
Moisture Resistance		Preconditioning: Run through IR reflow for 2 times.( IPC/JEDEC J-STD-020DClassification Reflow Profiles 1.Baked at 50℃ for 25hrs, measured at room temperature after placing for 4 hrs. 2.Raise temperature to 65 $\pm$ 2℃ 90-100%RH in 2.5hrs, and keep 3 hours, cool down to 25℃ in 2.5hrs. 3.Raise temperature to 65 $\pm$ 2℃ 90-100%RH in 2.5hrs, and keep 3 hours, cool down to 25℃ in 2.5hrs,keep at 25℃ for 2hrs then keep at -10℃ for 3hrs 4.Keep at 25℃ 80-100%RH for 15min and vibrate at the frequency of 10 to 55 Hz to 10 Hz, measure at room temperature after placing for 1~2 hrs.															
Biased Humidity (AEC-Q200)		Preconditioning: Run through IR reflow for 2 times.( IPC/JEDEC J-STD-020DClassification Reflow Profiles Humidity : 85 $\pm$ 3% R.H, Temperature: 85 $\pm$ 2℃ Duration : 1000hrs Min Measured at room temperature after placing for24 $\pm$ 2hrs															
High Temperature Operational Life (AEC-Q200)		Preconditioning: Run through IR reflow for 2 times.( IPC/JEDEC J-STD-020DClassification Reflow Profiles Temperature: 125 $\pm$ 2℃ (Inductor) Duration : 1000hrs Min. with 100% rated current. Measured at room temperature after placing for24 $\pm$ 2hrs															
External Visual	Appearance: No damage.	Inspect device construction, marking and workmanship. Electrical Test not required.															
Physical Dimension	According to the product specification size measurement	According to the product specification size measurement															
Resistance to Solvents	Appearance: No damage.	Add aqueous wash chemical - OKEM clean or equivalent.															
Mechanical Shock	Appearance: No damage. Impedance: within $\pm$ 15% of initial value Inductance: within $\pm$ 10% of initial value Q: Shall not exceed the specification value. RDC : within $\pm$ 15% of initial value and shall not exceed the specification value	<table border="1"> <thead> <tr> <th>Type</th> <th>Peak value (g's)</th> <th>Normal duration (D) (ms)</th> <th>Wave form</th> <th>Velocity change (V)ft/sec</th> </tr> </thead> <tbody> <tr> <td>SMD</td> <td>100</td> <td>6</td> <td>Half-sine</td> <td>12.3</td> </tr> <tr> <td>Lead</td> <td>100</td> <td>6</td> <td>Half-sine</td> <td>12.3</td> </tr> </tbody> </table> shocks in each direction along 3 perpendicular axes.	Type	Peak value (g's)	Normal duration (D) (ms)	Wave form	Velocity change (V)ft/sec	SMD	100	6	Half-sine	12.3	Lead	100	6	Half-sine	12.3
Type	Peak value (g's)	Normal duration (D) (ms)	Wave form	Velocity change (V)ft/sec													
SMD	100	6	Half-sine	12.3													
Lead	100	6	Half-sine	12.3													

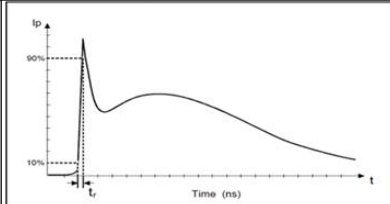
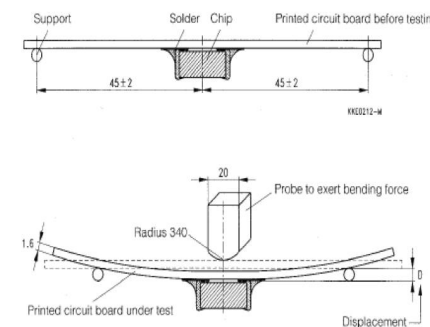
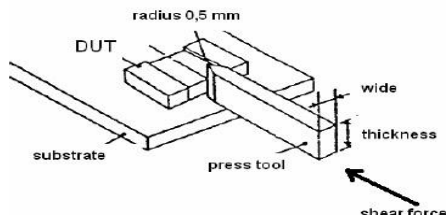
Item	Performance	Test Condition								
Vibration		IPC/JEDEC J-STD-020D Classification Reflow Profiles Oscillation Frequency: 10~2K~10Hz for 20 minute Equipment: Vibration checker Total Amplitude: 1.52mm±10% Testing Time : 12 hours(20 minutes, 12 cycles each of 3 orientations)								
Resistance to Soldering Heat	Appearance: No damage. Impedance: within±15% of initial value Inductance: within±10% of initial value Q: Shall not exceed the specification value. RDC : within ±15% of initial value and shall not exceed the specification value	Test condition : <table border="1" data-bbox="965 427 1417 510"> <thead> <tr> <th>Temperature(°C)</th> <th>Time(s)</th> <th>Temperature ramp/immersion and emersion rate</th> <th>Number of heat cycles</th> </tr> </thead> <tbody> <tr> <td>260±5(solder)</td> <td>10±1</td> <td>25mm/s ±6 mm/s</td> <td>1</td> </tr> </tbody> </table>	Temperature(°C)	Time(s)	Temperature ramp/immersion and emersion rate	Number of heat cycles	260±5(solder)	10±1	25mm/s ±6 mm/s	1
Temperature(°C)	Time(s)	Temperature ramp/immersion and emersion rate	Number of heat cycles							
260±5(solder)	10±1	25mm/s ±6 mm/s	1							
Thermal shock (AEC-Q200)		Preconditioning: Run through IR reflow for 2 times.( IPC/JEDEC J-STD-020D Classification Reflow Profiles Condition for 1 cycle Step1: -55±2°C 15±1min(Inductor) Step2: 125±2°C within 20Sec. Step3: 125±2°C 15±1min Number of cycles: 300 Measured at room tempraturc after placing fo24±2hrs								
ESD	Appearance: No damage.									
Solderability	More than 95% of the terminal electrode should be covered with solder.	a. Method B, 4 hrs @155°C dry heat @235°C±5°C b. Method B @ 215°C±5°C category 3.(8hours ± 15 min) c. Method D category 3. (8hours ± 15 min)@ 260°C±°C Preheat: 150°C,60sec. Solder: Sn96.5% Ag3% Cu0. 5% Temperature: 245±5°C。 Flux for lead free: Rosin. 9.5%。 Dip time: 4±1sec. Depth: completely cover the termination								
Electrical Characterization	Refer Specification for Approval	Summary to show Min, Max, Mean and Standard deviation .								
Flammability	Electrical Test not required.	V-0 or V-1 are acceptable.								
Board Flex	Appearance: No damage	Preconditioning: Run through IR reflow for 2 times.( IPC/JEDEC J-STD-020D Classification Reflow Profiles Place the 100mm X 40mm board into a fixture similar to the one shown in below Figure with the component facing down. The apparatus shall consist of mechanical means to apply a force which will bend the board (D) x = 2 mm minimum. The duration of the applied forces shall be 60 (+ 5) sec. The force is to be applied only once to the board. 								
Terminal Strength(SMD)	Appearance: No damage	Preconditioning: Run through IR reflow for 2 times.( IPC/JEDEC J-STD-020D Classification Reflow Profiles With the component mounted on a PCB with the device to be tested, apply a 17.7 N (1.8 Kg) force to the side of a device being tested. This force shall be applied for 60 +1 seconds. Also the force shall be applied gradually as not to apply a shock to the component being tested. 								

Note : When there are questions concerning measurement result : measurement shall be made after 48 ± 2 hours of recovery under the standard condition.

## 8. Soldering and Mounting

### (1) Soldering

Mildly activated rosin fluxes are preferred. The minimum amount of solder can lead to damage from the stresses caused by the difference in coefficients of expansion between solder, chip and substrate. TAI-TECH terminations are suitable for re-flow soldering systems. If hand soldering cannot be avoided, the preferred technique is the utilization of hot air soldering tools.

### (2) Solder re-flow:

Recommended temperature profiles for re-flow soldering in Figure 1.

### (3) Soldering Iron:

Products attachment with a soldering iron is discouraged due to the inherent process control limitations. In the event that a soldering iron must be employed the following precautions are recommended.

- Preheat circuit and products to 150°C
- Never contact the ceramic with the iron tip
- Use a 20 watt soldering iron with tip diameter of 1.0mm
- 355°C tip temperature (max)
- 1.0mm tip diameter (max)
- Limit soldering time to 4~5sec.

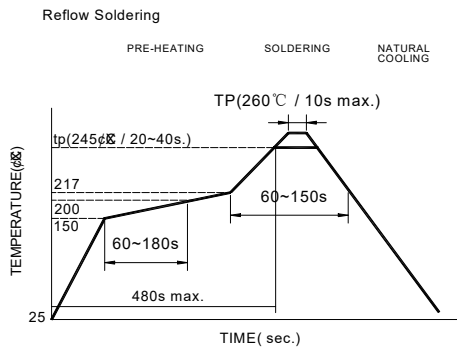

Reflow times: 3 times max.

Fig.1

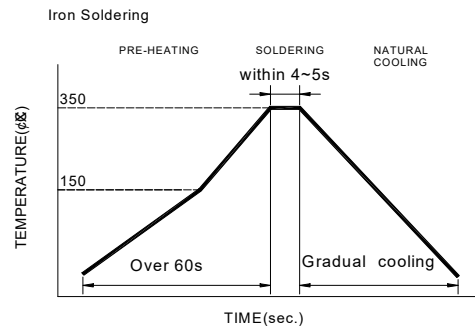

Iron Soldering times: 1 times max.

Fig.2

## 9. Packaging Information

### (1) Reel Dimension

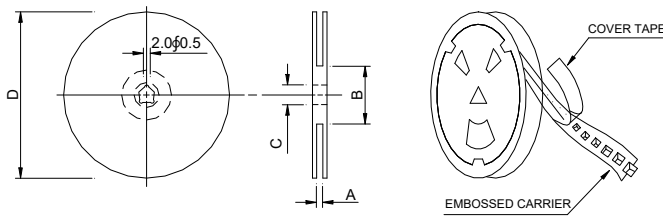

Type	A(mm)	B(mm)	C(mm)	D(mm)
13"x16mm	16.4±2/-0	100±2	13±0.5/-0.2	330

### (2) Tape Dimension

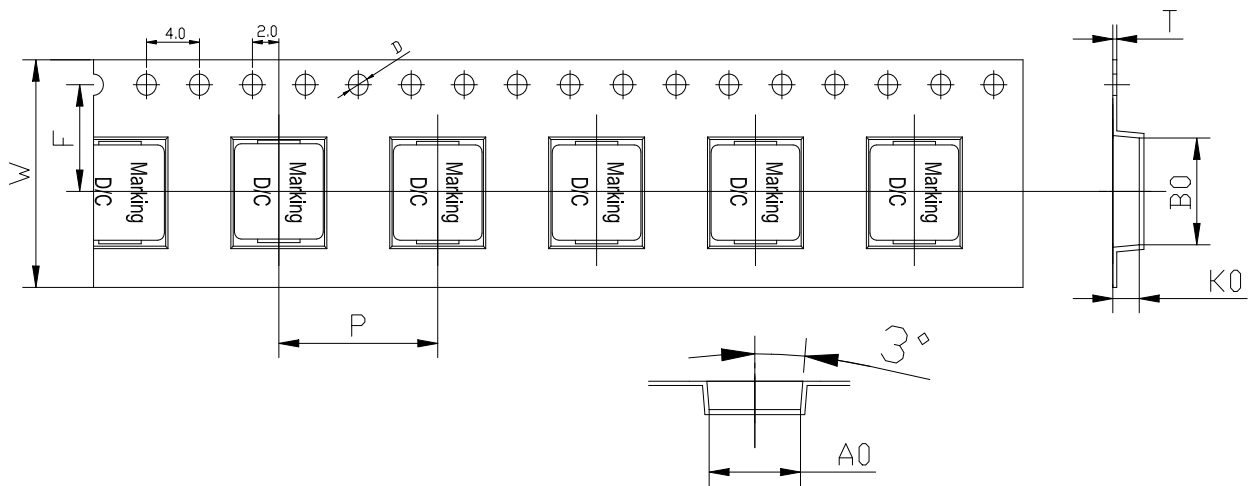

Series	Size	Bo(mm)	Ao(mm)	Ko(mm)	P(mm)	W(mm)	F(mm)	t(mm)	D(mm)
TMPC	0603	7.7±0.1	7.0±0.1	3.3±0.1	12.0±0.1	16±0.3	7.5±0.1	0.35±0.05	1.5±0.1

### (3) Packaging Quantity

TMPC	0603
Chip / Reel	1000
Inner box	2000
Carton	8000

### (4) Tearing Off Force

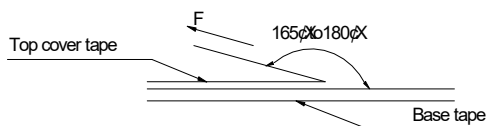

The force for tearing off cover tape is 10 to 130 grams in the arrow direction under the following conditions(referenced ANSI/EIA-481-D-2008 of 4.11 stadnard).

Room Temp. (°C)	Room Humidity (%)	Room atm (hPa)	Tearing Speed mm/min
5~35	45~85	860~1060	300

#### Application Notice

- Storage Conditions  
To maintain the solderability of terminal electrodes:
  1. TAI-TECH products meet IPC/JEDEC J-STD-020D standard-MSL, level 1.
  2. Temperature and humidity conditions: Less than 40°C and 60% RH.
  3. Recommended products should be used within 12 months form the time of delivery.
  4. The packaging material should be kept where no chlorine or sulfur exists in the air.
- Transportation
  1. Products should be handled with care to avoid damage or contamination from perspiration and skin oils.
  2. The use of tweezers or vacuum pick up is strongly recommended for individual components.
  3. Bulk handling should ensure that abrasion and mechanical shock are minimized.

### 10. Typical Performance Curves

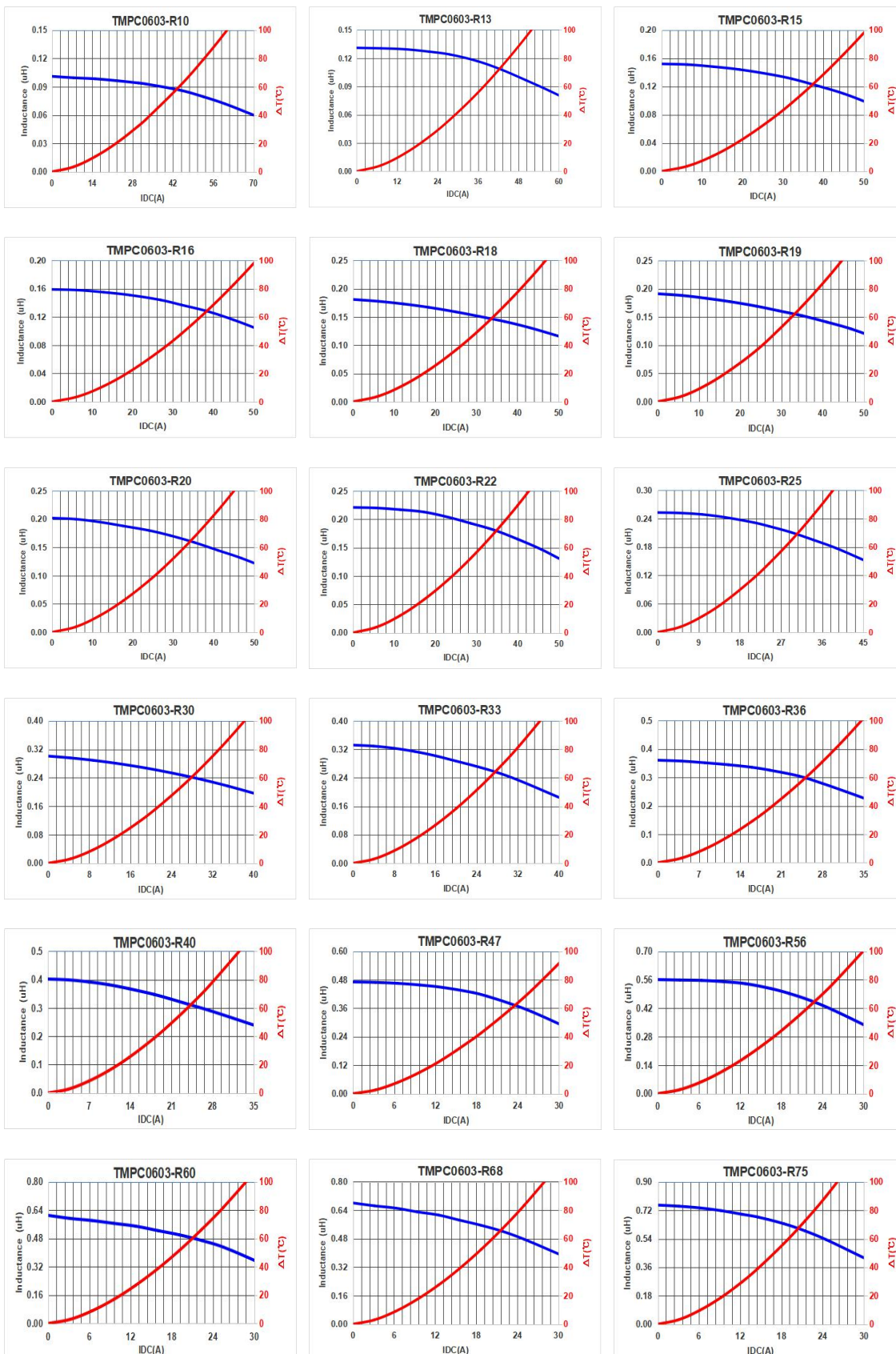



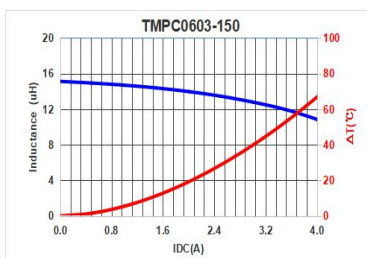
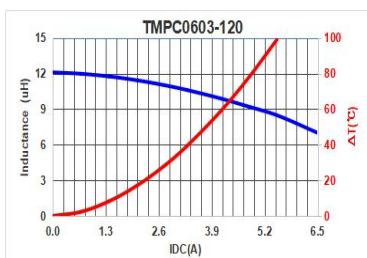
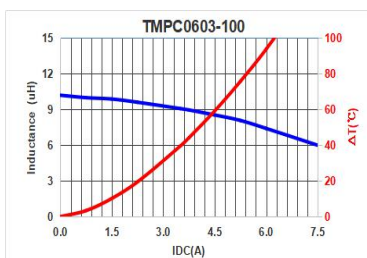
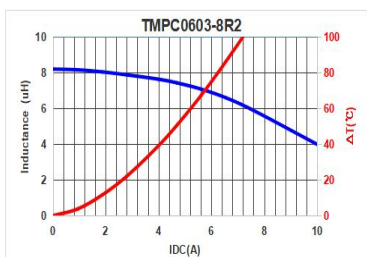
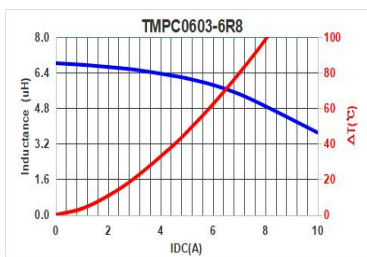
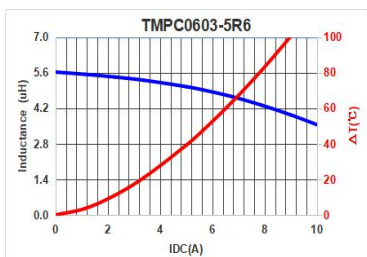
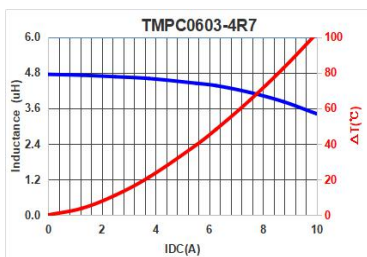
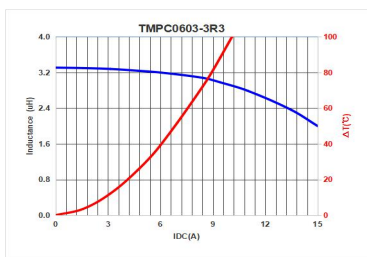
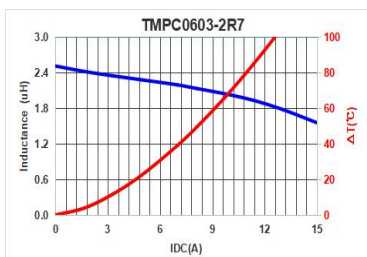
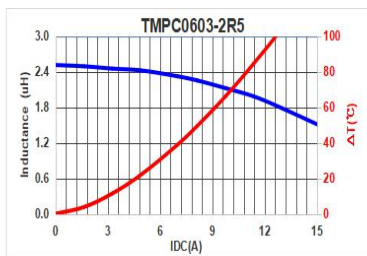
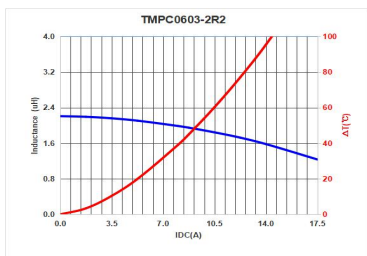
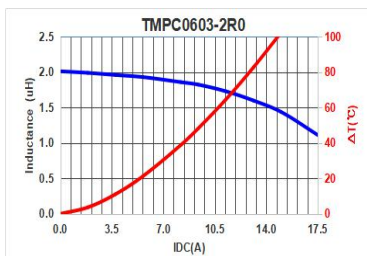
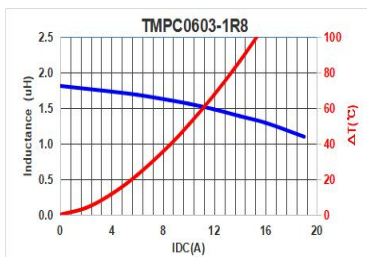
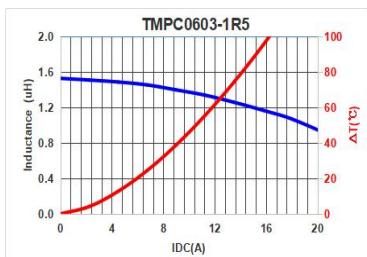
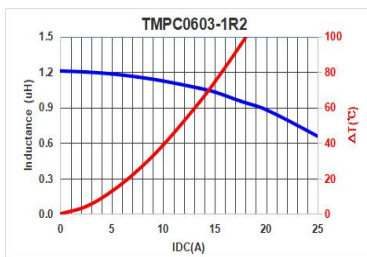
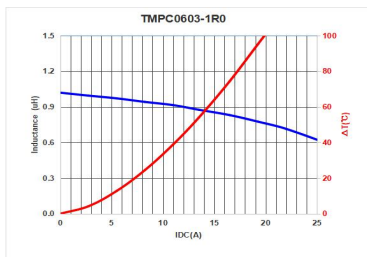
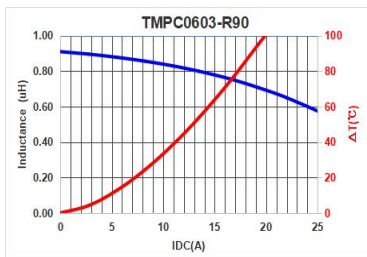
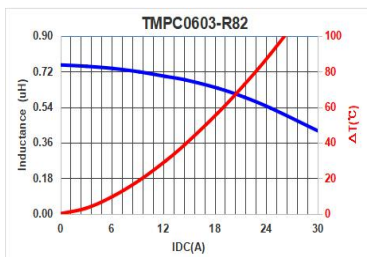

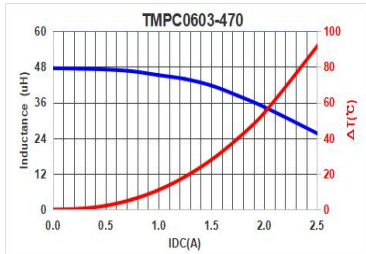
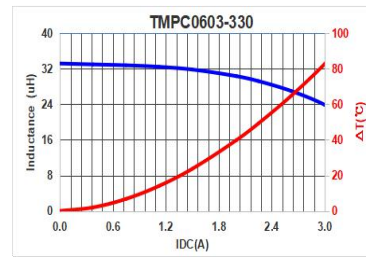
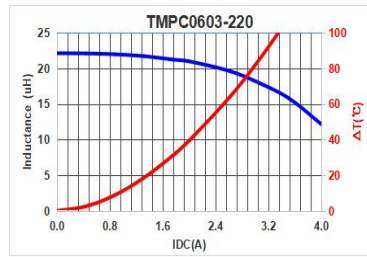
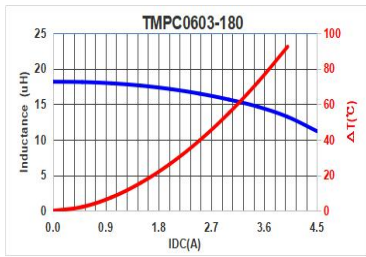

## X-ON Electronics

Largest Supplier of Electrical and Electronic Components

*Click to view similar products for [Fixed Inductors](#) category:*

*Click to view products by [Tai-Tech](#) manufacturer:*

Other Similar products are found below :

[MLZ1608M6R8WTD25](#) [MLZ1608N6R8LT000](#) [MLZ1608N3R3LTD25](#) [MLZ1608N3R3LT000](#) [MLZ1608N150LT000](#)  
[MLZ1608M150WTD25](#) [MLZ1608M3R3WTD25](#) [MLZ1608M3R3WT000](#) [MLZ1608M150WT000](#) [MLZ1608A1R5WT000](#)  
[MLZ1608N1R5LT000](#) [B82432C1333K000](#) [PCMB053T-1R0MS](#) [PCMB053T-1R5MS](#) [PCMB104T-1R5MS](#) [CR32NP-100KC](#) [CR32NP-151KC](#) [CR32NP-180KC](#) [CR32NP-181KC](#) [CR32NP-1R5MC](#) [CR32NP-390KC](#) [CR32NP-3R9MC](#) [CR32NP-680KC](#) [CR32NP-820KC](#)  
[CR32NP-8R2MC](#) [CR43NP-390KC](#) [CR43NP-560KC](#) [CR43NP-680KC](#) [CR54NP-181KC](#) [CR54NP-470LC](#) [CR54NP-820KC](#) [CR54NP-8R5MC](#)  
[ET3542-057](#) [MGDQ4-00004-P](#) [MGDU1-00016-P](#) [MHL1ECTTP18NJ](#) [MHL1JCTTD12NJ](#) [PE-51506NL](#) [PE-53601NL](#) [PE-53630NL](#) [PE-53824SNLT](#) [PE-62892NL](#) [PE-92100NL](#) [PG0434.801NLT](#) [PG0936.113NLT](#) [PM06-2N7](#) [PM06-39NJ](#) [HC2LP-R47-R](#) [HC2-R47-R](#) [HC3-2R2-R](#)