

# Specification for Approval

**Date:** 2013/03/22

**Customer :** 東莞台慶

**TAI-TECH P/N:** UHP252012NF-SERIES

**CUSTOMER P/N:** \_\_\_\_\_

**DESCRIPTION:** \_\_\_\_\_

**QUANTITY:** \_\_\_\_\_ pcs

<b>REMARK:</b>		
Customer Approval Feedback		

西北臺慶科技股份有限公司  
**TAI-TECH Advanced Electronics Co., Ltd**

西北臺慶科技股份有限公司  
 TAI-TECH Advanced Electronics Co., Ltd  
 Headquarter:  
 NO.1 YOU 4TH ROAD, YOUTH INDUSTRIAL DISTRICT, YANG-MEI,  
 TAO-YUAN HSIEN, TAIWAN, R.O.C.  
 TEL: +886-3-4641148 FAX: +886-3-4643565  
 http://www.tai-tech.com.tw  
 E-mail: sales@tai-tech.com.tw

東莞臺慶精密電子有限公司  
 DONGGUAN TAI-TECH ADVANCED ELECTRONICS CO., LTD  
 JITIGANG MANAGEMENT DISTRICT, HUANGJIANG, DONGGUAN,  
 GUANGDONG, CHINA  
 TEL: +86-769-3365488 FAX: +86-769-3366896  
 E-mail: twnwe@pub.dgnet.gd.cn

Office:  
 金亨國際有限公司  
 KAMHENG INTERNATIONAL LIMITED  
 TEL: +86-852-25772033 FAX: +86-852-28817778

臺慶精密電子(昆山)有限公司  
 TAI-TECH ADVANCED ELECTRONICS(KUNSHAN) CO., LTD  
 SHINWHA ROAD, KUNJIA HI-TECH INDUSTRIAL PARK, KUN-SHAN,  
 JIANG-SU, CHINA  
 TEL: +86-512-57619396 FAX: +86-512-57619688  
 E-mail: hui@tai-tech.com.tw

Office:  
 北欣國際有限公司  
 NORTH STAR INTERNATIONAL LIMITED  
 TEL: +86-512-57619396 FAX: +86-512-57619688

Sales Dep.

APPROVED	CHECKED
管哲頌 Eric Kuan	曾詩涵 Angela Tseng

R&D Center

APPROVED	CHECKED	DRAWN
楊祥忠 Mikey Yang	詹偉特 Jack Chan	林宜瀟 Beryl Lin



# Power Inductor

**UHP252012NF-SERIES**

## 1. Features

1. This specification applies Low Profile Power Inductors.
2. 100% Lead(Pb) & Halogen-Free and RoHS compliant.



## 2. Dimension

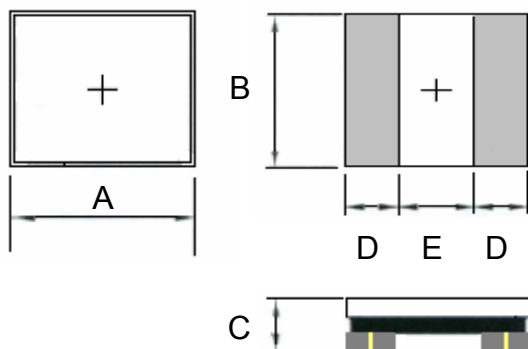

Series	A(mm)	B(mm)	C(mm)	D(mm)	E(mm)
UHP252012NF	2.5 -0.1/+0.3	2.0 -0.05/+0.35	1.2 max.	0.85 ref.	0.80 ref.

Units: mm

## 3. Part Numbering

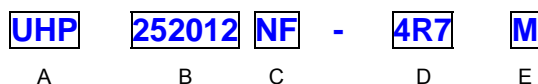

A: Series

B: Dimension

C: Lead Free

Material

D: Inductance

4R7=4.7uH

E: Inductance Tolerance

M=±20%

## 4. Specification

TAI-TECH Part Number	Inductance (uH)	Tolerance (%)	Test Frequency (Hz)	DCR (Ω) ±20%	I sat (A) typ.	I sat (A) Max.	I rms (A) typ	I rms (A) Max.
UHP252012NF-R47M	0.47	±20%	0.1V/1M	0.028	4.00	3.60	3.70	3.35
UHP252012NF-R68M	0.68	±20%	0.1V/1M	0.036	3.00	2.70	3.30	3.00
UHP252012NF-1R0M	1.0	±20%	0.1V/1M	0.049	2.70	2.45	2.60	2.30
UHP252012NF-1R5M	1.5	±20%	0.1V/1M	0.063	2.30	2.05	2.20	1.95
UHP252012NF-2R2M	2.2	±20%	0.1V/1M	0.080	2.15	1.95	1.85	1.65
UHP252012NF-3R3M	3.3	±20%	0.1V/1M	0.120	1.70	1.50	1.45	1.30
UHP252012NF-4R7M	4.7	±20%	0.1V/1M	0.176	1.50	1.35	1.20	1.05
UHP252012NF-6R8M	6.8	±20%	0.1V/1M	0.250	1.15	1.00	1.00	0.90
UHP252012NF-100M	10	±20%	0.1V/1M	0.410	0.85	0.75	0.75	0.65
UHP252012NF-150M	15	±20%	0.1V/1M	0.540	0.63	0.56	0.60	0.54
UHP252012NF-220M	22	±20%	0.1V/1M	0.850	0.56	0.50	0.50	0.45

Note:

Isat : Based on inductance change (ΔL/L0 : ≤-30%) @ ambient temp. 25°C

Irms : Based on temperature rise (ΔT : 40°C.)

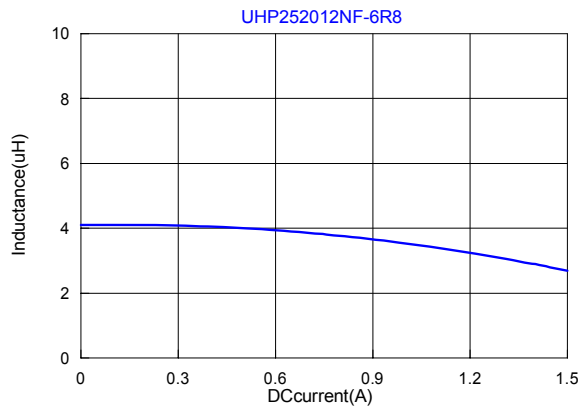
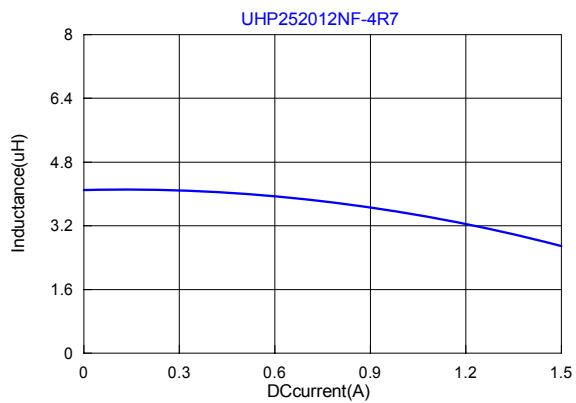
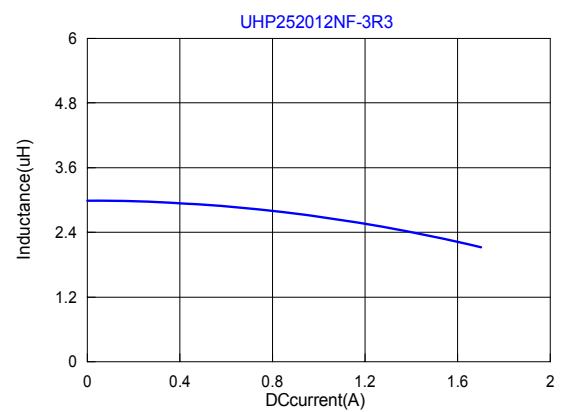
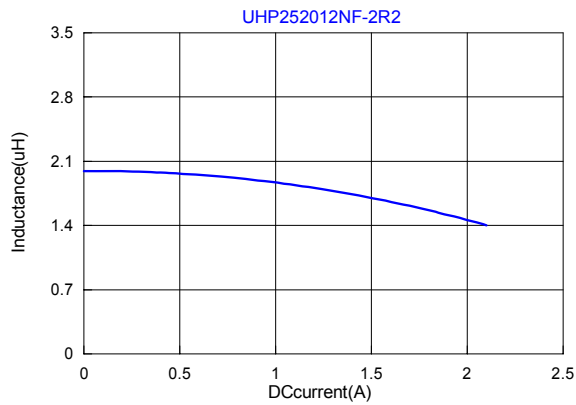
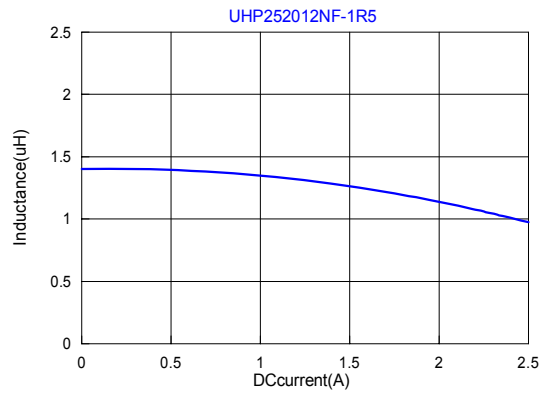
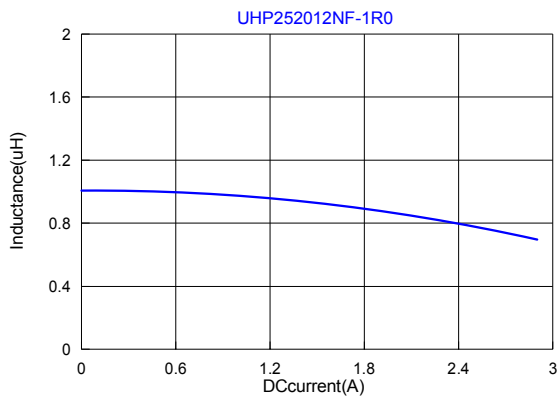
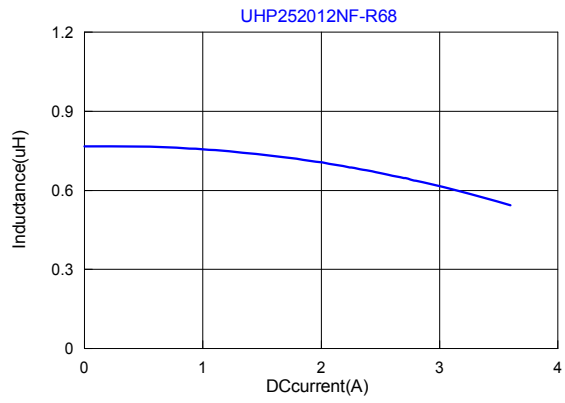
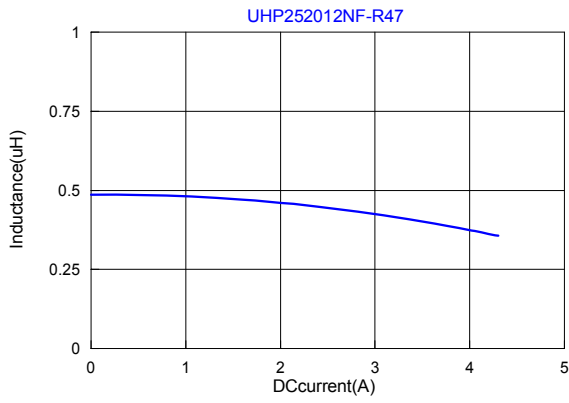

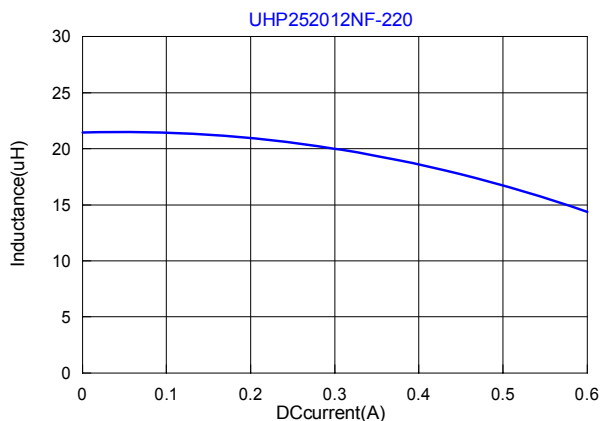
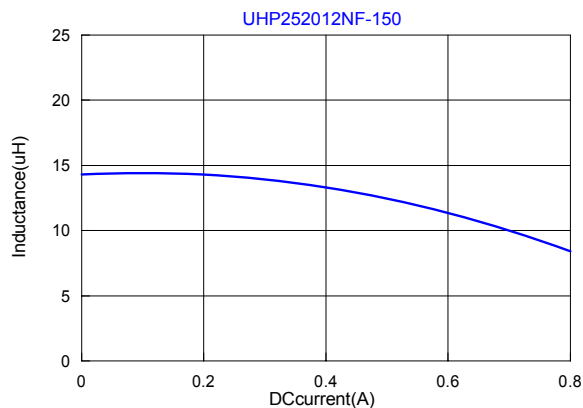
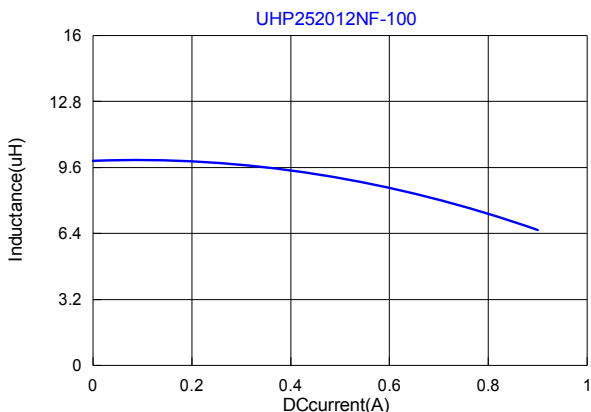

5. Material List

No.	Description	Specification
a.	Core	Ferrite N4 Core
b.	Coating	Epoxy
c.	Termination	Tin Pb Free
d.	Wire	Enameled Copper Wire

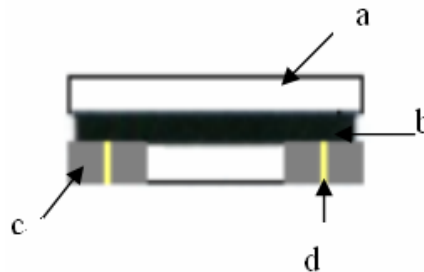

6. Reliability and Test Condition

Item	Performance	Test Condition
Operating Temperature	-40~+85°C (For products in unopened tape package, less than 40°C)	
<b>Electrical Performance Test</b>		
Inductance L	Refer to standard electrical characteristic list	Agilent-4291, Agilent-4287
Q		Agilent-4192, Agilent-4285
SRF		Agilent-4291
DC Resistance		Agilent-4338
Rated Current	Base on temp. rise & $\Delta L/L0A \leq 30\%$ .	Saturation DC Current (Isat) will cause L0 to drop approximately $\Delta L(\%)$ .

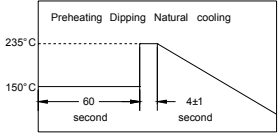
Item	Performance	Test Condition												
Temperature Rise Test	$\Delta T$ 40°C Max	Heat Rated Current (Irms) will cause the coil temperature rise approximately $\Delta T(^{\circ}C)$ without core loss. 1.Applied the allowed DC current. 2.Temperature measured by digital surface thermometer												
<b>Mechanical Performance Test</b>														
Resistance to Soldering Heat MIL-STD-202 METHOD 210	1. Inductors shall be no evidence of electrical and mechanical damage. 2. Inductance : within $\pm 10\%$ of initial value	Temp.: 260 $\pm 5^{\circ}C$ Time: 10 $\pm 1.0$ Sec												
Solderability Test ANSI/J-STD-002	More than 95% of terminal electrode should be covered with solder.	 <p>After fluxing, component shall be dipped in a melted solder bath at 235<math>\pm 5^{\circ}C</math> for 4<math>\pm 1</math>seconds.</p>												
<b>Reliability Test</b>														
Humidity Test MIL-STD-202 METHOD 103	1. Visual examination : No mechanical damage 2. Inductance : within $\pm 10\%$ of initial value	1. Temperature : 40 $\pm 2^{\circ}C$ 2. Humidity : 90 ~ 95% 3. Time : 500 $\pm 8$ hrs 4. Measured at room temperature after placing for 2 to 3 hrs												
Thermal Shock Test MIL-STD-202 METHOD 107	1. Visual examination : No mechanical damage	<p>Conditions for 1 cycle</p> <table border="1" data-bbox="1129 1115 1417 1249"> <thead> <tr> <th>Step</th> <th>Temperature(<math>^{\circ}C</math>)</th> <th>Times(min.)</th> </tr> </thead> <tbody> <tr> <td>1</td> <td>-55<math>\pm 2</math></td> <td>30<math>\pm 3</math></td> </tr> <tr> <td>2</td> <td>Room Temperature</td> <td>Within 5</td> </tr> <tr> <td>2</td> <td>85<math>\pm 5</math></td> <td>30<math>\pm 3</math></td> </tr> </tbody> </table> <p>Total: 100 cycles Measured at room temperature after placing for 2 to 3 hrs</p>	Step	Temperature( $^{\circ}C$ )	Times(min.)	1	-55 $\pm 2$	30 $\pm 3$	2	Room Temperature	Within 5	2	85 $\pm 5$	30 $\pm 3$
Step	Temperature( $^{\circ}C$ )	Times(min.)												
1	-55 $\pm 2$	30 $\pm 3$												
2	Room Temperature	Within 5												
2	85 $\pm 5$	30 $\pm 3$												
High Temperature Life Test MIL-STD-202 METHOD 108	2. Inductance : within $\pm 10\%$ of initial value	1. Temperature : 85 $\pm 2^{\circ}C$ 2. Time : 500 $\pm 8$ hrs 3. Measured at room temperature after placing for 2to3 hrs												
Humidity Resistance Test MIL-STD-202 METHOD 103		1. Temperature: 40 $\pm 2^{\circ}C$ 2. Humidity: 90~ 95% 3. Time: 500 $\pm 8$ hr. 4. Recovery: 2 to 3hrs of recovery under the standard condition after the removal from test chamber.												
Low temperature Storage Test JESD22-A119		1. Temperature : -40 $\pm 2^{\circ}C$ 2. Time : 500 $\pm 8$ hrs 3. Measured at room temperature after placing for 2to3 hrs												
Random Vibration Test MIL-STD-202 Method 204	Appearance: Cracking, shipping and any other defects harmful to the characteristics should not be allowed. Impedance: within $\pm 30\%$	Frequency: 10-55-10Hz for 15 min. Amplitude: 1.52mm Directions and times: X, Y, Z directions for 15 min. This cycle shall be performed 12 times in each of three mutually perpendicular directions (Total 9hours).												

## 7. Soldering and Mounting

### 7-1. Soldering

Mildly activated rosin fluxes are preferred. TAI-TECH terminations are suitable for all wave and re-flow soldering systems. If hand soldering cannot be avoided, the preferred technique is the utilization of hot air soldering tools.

#### 7-1.1 Solder re-flow:

Recommended temperature profiles for re-flow soldering in Figure 1.

#### 7-1.2 Soldering Iron(Figure 2):

Products attachment with a soldering iron is discouraged due to the inherent process control limitations. In the event that a soldering iron must be employed the following precautions are recommended.

- Preheat circuit and products to 150°C
- Never contact the ceramic with the iron tip
- Use a 20 watt soldering iron with tip diameter of 1.0mm
- 355°C tip temperature (max)
- 1.0mm tip diameter (max)
- Limit soldering time to 4~5 sec.

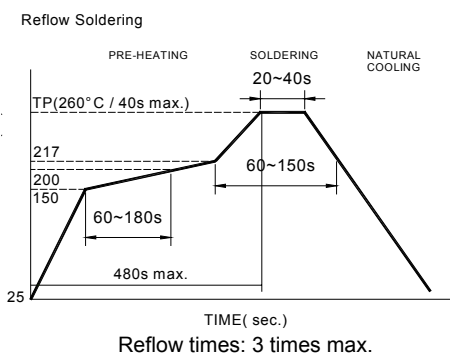

Reflow times: 3 times max.

Fig.1

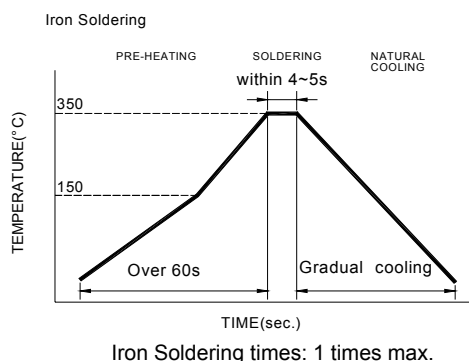

Iron Soldering times: 1 times max.

Fig.2

### 7-2. Recommended PC Board Pattern

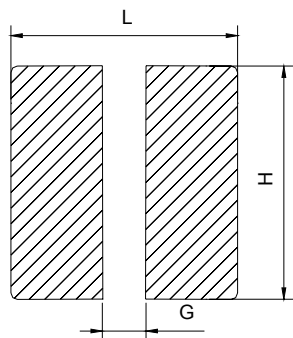

L(mm)	G(mm)	H(mm)
2.9	0.8	2.4

## 8. Packaging Information

### 8-1. Reel Dimension

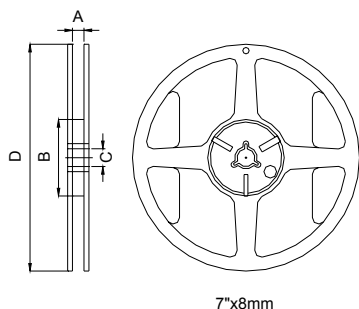

Type	A(mm)	B(mm)	C(mm)	D(mm)
7"x8mm	8.4±1.0	50 min.	13±0.8	178±2

### 8-2. Tape Dimension / 8mm

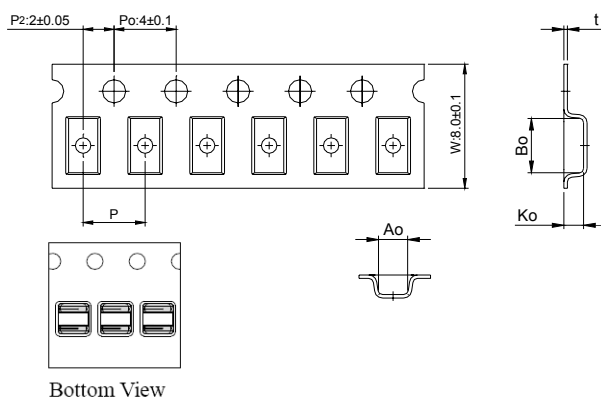

Series	Size	Bo(mm)	Ao(mm)	Ko(mm)	P(mm)	t(mm)
UHP	252012	3.10±0.1	2.45±0.1	1.40±0.1	4.0±0.1	0.23±0.05

### 8-3. Packaging Quantity

Chip size	252012
Chip / Reel	2000

### 8-4. Tearing Off Force

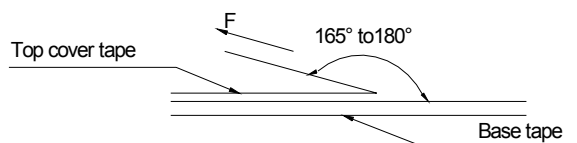

The force for tearing off cover tape is 15 to 80 grams in the arrow direction under the following conditions.

Room Temp. (°C)	Room Humidity (%)	Room atm (hPa)	Tearing Speed mm/min
5~35	45~85	860~1060	300

#### Application Notice

- Storage Conditions

To maintain the solderability of terminal electrodes:

1. TAI-TECH products meet IPC/JEDEC J-STD-020D standard-MSL, level 1.
2. Temperature and humidity conditions: Less than 40°C and 60% RH.
3. Recommended products should be used within 12 months from the time of delivery.
4. The packaging material should be kept where no chlorine or sulfur exists in the air.

- Transportation

1. Products should be handled with care to avoid damage or contamination from perspiration and skin oils.
2. The use of tweezers or vacuum pick up is strongly recommended for individual components.
3. Bulk handling should ensure that abrasion and mechanical shock are minimized.



# 測試報告 Test Report

號碼(No.) : CE/2013/23406 日期(Date) : 2013/03/01 頁數(Page) : 1 of 8

西北臺慶科技股份有限公司 / TAI-TECH ADVANCED ELECTRONICS CO., LTD.  
 (東莞臺慶精密電子有限公司 / TAI-TECH ADVANCED ELECTRONICS (DONGGUAN) CO. LTD.)  
 (臺慶精密電子(昆山)有限公司 / TAI-TECH ADVANCED ELECTRONICS (KUN-SHAN) CO.  
 桃園縣楊梅市幼獅工業區幼四路1之1號 (NO. 1, YOU 4TH ROAD, YOUTH INDUSTRIAL DISTRICT, YANG-MEI CITY, TAO-YUAN  
 HSIEN, TAIWAN R. O. C.)  
 (廣東省東莞市黃江鎮黃牛埔福祥街2號 / NO. 2, FUXIANG STREET, HUANGNIUPU, HUANGJIANG TOWN, DONGGUAN, GUANGDONG)  
 (江蘇省昆山市蓬朗昆嘉高科技工業區郭澤路 / GUO-ZE ROAD, KUNJIA HI-TECH INDUSTRIAL PARK, KUN-SHAN, JIANG-SU,  
 CHINA)



以下測試樣品係由客戶送樣，且由客戶聲稱並經客戶確認如下 (The following samples was/were submitted and identified by/on behalf of the client as) :

樣品名稱(Sample Description) : SMD POWER INDUCTOR  
 樣品型號(Style/Item No.) : HPC, SPC, UHP, SPC, TLPC, TLPH, SPI SERIES  
 收件日期(Sample Receiving Date) : 2013/02/22  
 測試期間(Testing Period) : 2013/02/22 TO 2013/03/01

=====  
 測試需求(Test Requested) : (1) 依據客戶指定，進行鎘，鉛，汞，六價鉻，多溴聯苯，多溴聯苯醚測試。(As specified by client, to test Cadmium, Lead, Mercury, Cr(VI), PBBs, PBDEs contents in the submitted sample.)  
 (2) 依據客戶指定，進行鹵素-氟、氯、溴、碘測試。(As specified by client, to test Halogen-Fluorine, Chlorine, Bromine, Iodine contents in the submitted sample.)  
 測試方法(Test Method) : 請見下一頁 (Please refer to next pages).  
 測試結果(Test Results) : 請見下一頁 (Please refer to next pages).



Chenyu Kung / Operation Manager  
 Signed for and on behalf of  
 SGS TAIWAN LTD.  
 Chemical Laboratory - Taipei



# 測試報告

## Test Report

號碼(No.) : CE/2013/23406 日期(Date) : 2013/03/01 頁數(Page) : 2 of 8



西北臺慶科技股份有限公司 / TAI-TECH ADVANCED ELECTRONICS CO., LTD.  
 (東莞臺慶精密電子有限公司 / TAI-TECH ADVANCED ELECTRONICS (DONGGUAN) CO. LTD.)  
 (臺慶精密電子(昆山)有限公司 / TAI-TECH ADVANCED ELECTRONICS (KUN-SHAN) CO.  
 桃園縣楊梅市幼獅工業區幼四路1之1號 (NO. 1, YOU 4TH ROAD, YOUTH INDUSTRIAL DISTRICT, YANG-MEI CITY, TAO-YUAN HSIEN, TAIWAN R. O. C.)  
 (廣東省東莞市黃江鎮黃牛埔福祥街2號 / NO. 2, FUXIANG STREET, HUANGNIUPU, HUANGJIANG TOWN, DONGGUAN, GUANGDONG)  
 (江蘇省昆山市蓬朗昆嘉高科技工業區郭澤路 / GUO-ZE ROAD, KUNJIA HI-TECH INDUSTRIAL PARK, KUN-SHAN, JIANG-SU, CHINA)

### 測試結果(Test Results)

測試部位(PART NAME) No.1 : 整體混測(5款) (MIXED ALL PARTS(5 TYPES))

測試項目 (Test Items)	單位 (Unit)	測試方法 (Method)	方法偵測 極限值 (MDL)	結果 (Result)
				No.1
鎘 / Cadmium (Cd)	mg/kg	參考IEC 62321: 2008方法, 以感應耦合電漿原子發射光譜儀檢測。 / With reference to IEC 62321: 2008 and performed by ICP-AES.	2	n.d.
鉛 / Lead (Pb)	mg/kg	參考IEC 62321: 2008方法, 以感應耦合電漿原子發射光譜儀檢測。 / With reference to IEC 62321: 2008 and performed by ICP-AES.	2	n.d.
汞 / Mercury (Hg)	mg/kg	參考IEC 62321: 2008方法, 以感應耦合電漿原子發射光譜儀檢測。 / With reference to IEC 62321: 2008 and performed by ICP-AES.	2	n.d.
六價鉻 / Hexavalent Chromium Cr(VI)	mg/kg	參考IEC 62321: 2008方法, 以UV-VIS檢測。 / With reference to IEC 62321: 2008 and performed by UV-VIS.	2	n.d.
鹵素 / Halogen				
鹵素(氟) / Halogen-Fluorine (F) (CAS No.: 14762-94-8)	mg/kg	參考BS EN 14582:2007, 以離子層析儀分析。 / With reference to BS EN 14582:2007. Analysis was performed by IC.	50	n.d.
鹵素(氯) / Halogen-Chlorine (Cl) (CAS No.: 22537-15-1)			50	n.d.
鹵素(溴) / Halogen-Bromine (Br) (CAS No.: 10097-32-2)			50	n.d.
鹵素(碘) / Halogen-Iodine (I) (CAS No.: 14362-44-8)			50	n.d.

This document is issued by the Company subject to its General Conditions of Service printed overleaf, available on request or accessible at <http://www.sgs.com.tw/TermsandConditions.aspx> and, for electronic format documents, subject to Terms and Conditions for Electronic Documents at <http://www.sgs.com.tw/TermsandConditions/ElectronicDocument.aspx>. Attention is drawn to the limitation of liability, indemnification and jurisdiction issues defined therein. Any holder of this document is advised that information contained hereon reflects the Company's findings at the time of its intervention only and within the limits of client's instruction, if any. The Company's sole responsibility is to its Client and this document does not exonerate parties to a transaction from exercising all their rights and obligations under the transaction documents. This document cannot be reproduced, except in full, without prior written approval of the Company. Any unauthorized alteration, forgery or falsification of the content or appearance of this document is unlawful and offenders may be prosecuted to the fullest extent of the law. Unless otherwise stated the results shown in this test report refer only to the sample(s) tested.



# 測試報告

## Test Report

號碼(No.) : CE/2013/23406 日期(Date) : 2013/03/01 頁數(Page) : 3 of 8



西北臺慶科技股份有限公司 / TAI-TECH ADVANCED ELECTRONICS CO., LTD.

(東莞臺慶精密電子有限公司 / TAI-TECH ADVANCED ELECTRONICS (DONGGUAN) CO. LTD.)

(臺慶精密電子(昆山)有限公司 / TAI-TECH ADVANCED ELECTRONICS (KUN-SHAN) CO.

桃園縣楊梅市幼獅工業區幼四路1之1號 (NO. 1, YOU 4TH ROAD, YOUTH INDUSTRIAL DISTRICT, YANG-MEI CITY, TAO-YUAN HSIEN, TAIWAN R. O. C.)

(廣東省東莞市黃江鎮黃牛埔福祥街2號 / NO. 2, FUXIANG STREET, HUANGNIUPU, HUANGJIANG TOWN, DONGGUAN, GUANGDONG)

(江蘇省昆山市蓬朗昆嘉高科技工業區郭澤路 / GUO-ZE ROAD, KUNJIA HI-TECH INDUSTRIAL PARK, KUN-SHAN, JIANG-SU, CHINA)

測試項目 (Test Items)	單位 (Unit)	測試方法 (Method)	方法偵測 極限值 (MDL)	結果 (Result)
				No.1
多溴聯苯總和 / Sum of PBBs	mg/kg	參考IEC 62321: 2008方法, 以氣相層析/質譜儀檢測. / With reference to IEC 62321: 2008 and performed by GC/MS.	-	n.d.
一溴聯苯 / Monobromobiphenyl			5	n.d.
二溴聯苯 / Dibromobiphenyl			5	n.d.
三溴聯苯 / Tribromobiphenyl			5	n.d.
四溴聯苯 / Tetrabromobiphenyl			5	n.d.
五溴聯苯 / Pentabromobiphenyl			5	n.d.
六溴聯苯 / Hexabromobiphenyl			5	n.d.
七溴聯苯 / Heptabromobiphenyl			5	n.d.
八溴聯苯 / Octabromobiphenyl			5	n.d.
九溴聯苯 / Nonabromobiphenyl			5	n.d.
十溴聯苯 / Decabromobiphenyl			5	n.d.
多溴聯苯醚總和 / Sum of PBDEs			-	n.d.
一溴聯苯醚 / Monobromodiphenyl ether			5	n.d.
二溴聯苯醚 / Dibromodiphenyl ether			5	n.d.
三溴聯苯醚 / Tribromodiphenyl ether			5	n.d.
四溴聯苯醚 / Tetrabromodiphenyl ether			5	n.d.
五溴聯苯醚 / Pentabromodiphenyl ether			5	n.d.
六溴聯苯醚 / Hexabromodiphenyl ether			5	n.d.
七溴聯苯醚 / Heptabromodiphenyl ether			5	n.d.
八溴聯苯醚 / Octabromodiphenyl ether			5	n.d.
九溴聯苯醚 / Nonabromodiphenyl ether	5	n.d.		
十溴聯苯醚 / Decabromodiphenyl ether	5	n.d.		

This document is issued by the Company subject to its General Conditions of Service printed overleaf, available on request or accessible at <http://www.sgs.com.tw/Terms-and-Conditions.aspx> and, for electronic format documents, subject to Terms and Conditions for Electronic Documents at <http://www.sgs.com.tw/Terms-and-Conditions/jeimsc-Documents.aspx>. Attention is drawn to the limitation of liability, indemnification and jurisdiction issues defined therein. Any holder of this document is advised that information contained hereon reflects the Company's findings at the time of its intervention only and within the limits of client's instruction, if any. The Company's sole responsibility is to its Client and this document does not exonerate parties to a transaction from exercising all their rights and obligations under the transaction documents. This document cannot be reproduced, except in full, without prior written approval of the Company. Any unauthorized alteration, forgery or falsification of the content or appearance of this document is unlawful and offenders may be prosecuted to the fullest extent of the law. Unless otherwise stated the results shown in this test report refer only to the sample(s) tested.



# 測試報告 Test Report

號碼(No.) : CE/2013/23406 日期(Date) : 2013/03/01 頁數(Page) : 4 of 8

西北臺慶科技股份有限公司 / TAI-TECH ADVANCED ELECTRONICS CO., LTD.

(東莞臺慶精密電子有限公司 / TAI-TECH ADVANCED ELECTRONICS (DONGGUAN) CO. LTD.)

(臺慶精密電子(昆山)有限公司 / TAI-TECH ADVANCED ELECTRONICS (KUN-SHAN) CO.

桃園縣楊梅市幼獅工業區幼四路1之1號 (NO. 1, YOU 4TH ROAD, YOUTH INDUSTRIAL DISTRICT, YANG-MEI CITY, TAO-YUAN HSIEN, TAIWAN R. O. C.)

(廣東省東莞市黃江鎮黃牛埔福祥街2號 / NO. 2, FUXIANG STREET, HUANGNIUPU, HUANGJIANG TOWN, DONGGUAN, GUANGDONG)

(江蘇省昆山市蓬朗昆嘉高科技工業區郭澤路 / GUO-ZE ROAD, KUNJIA HI-TECH INDUSTRIAL PARK, KUN-SHAN, JIANG-SU, CHINA)



## 備註(Note) :

1. mg/kg = ppm ; 0.1wt% = 1000ppm
2. n.d. = Not Detected (未檢出)
3. MDL = Method Detection Limit (方法偵測極限值)
4. "-" = Not Regulated (無規格值)
5. 樣品的測試是基於申請人要求混合測試，報告中的混合測試結果不代表其中個別單一材質的含量。  
(The samples was/were analyzed on behalf of the applicant as mixing sample in one testing.  
The above results was/were only given as the informality value.)

This document is issued by the Company subject to its General Conditions of Service printed overleaf, available on request or accessible at <http://www.sgs.com/en/Terms-and-Conditions.aspx> and, for electronic format documents, subject to Terms and Conditions for Electronic Documents at <http://www.sgs.com/en/Terms-and-Conditions/Terms-Electronic-Documents.aspx>. Attention is drawn to the limitation of liability, indemnification and jurisdiction issues defined therein. Any holder of this document is advised that information contained hereon reflects the Company's findings at the time of its intervention only and within the limits of client's instruction, if any. The Company's sole responsibility is to its Client and this document does not exonerate parties to a transaction from exercising all their rights and obligations under the transaction documents. This document cannot be reproduced, except in full, without prior written approval of the Company. Any unauthorized alteration, forgery or falsification of the content or appearance of this document is unlawful and offenders may be prosecuted to the fullest extent of the law. Unless otherwise stated the results shown in this test report refer only to the sample(s) tested.

## 測試報告 Test Report

號碼(No.) : CE/2013/23406 日期(Date) : 2013/03/01 頁數(Page) : 5 of 8

西北臺慶科技股份有限公司 / TAI-TECH ADVANCED ELECTRONICS CO., LTD.

(東莞臺慶精密電子有限公司 / TAI-TECH ADVANCED ELECTRONICS (DONGGUAN) CO. LTD.)

(臺慶精密電子(昆山)有限公司 / TAI-TECH ADVANCED ELECTRONICS (KUN-SHAN) CO.

桃園縣楊梅市幼獅工業區幼四路1之1號 (NO. 1, YOU 4TH ROAD, YOUTH INDUSTRIAL DISTRICT, YANG-MEI CITY, TAO-YUAN HSIEN. TAIWAN R. O. C.)

(廣東省東莞市黃江鎮黃牛埔福祥街2號 / NO. 2, FUXIANG STREET, HUANGNIUPU, HUANGJIANG TOWN, DONGGUAN, GUANGDONG)

(江蘇省昆山市蓬朗昆嘉高科技工業區郭澤路 / GUO-ZE ROAD, KUNJIA HI-TECH INDUSTRIAL PARK, KUN-SHAN, JIANG-SU, CHINA)



- 1) 根據以下的流程圖之條件，樣品已完全溶解。(六價鉻測試方法除外) / These samples were dissolved totally by pre-conditioning method according to below flow chart. (Cr<sup>6+</sup> test method excluded)
- 2) 測試人員：楊登偉 / Name of the person who made measurement: Climbgreat Yang
- 3) 測試負責人：張啓興 / Name of the person in charge of measurement: Troy Chang

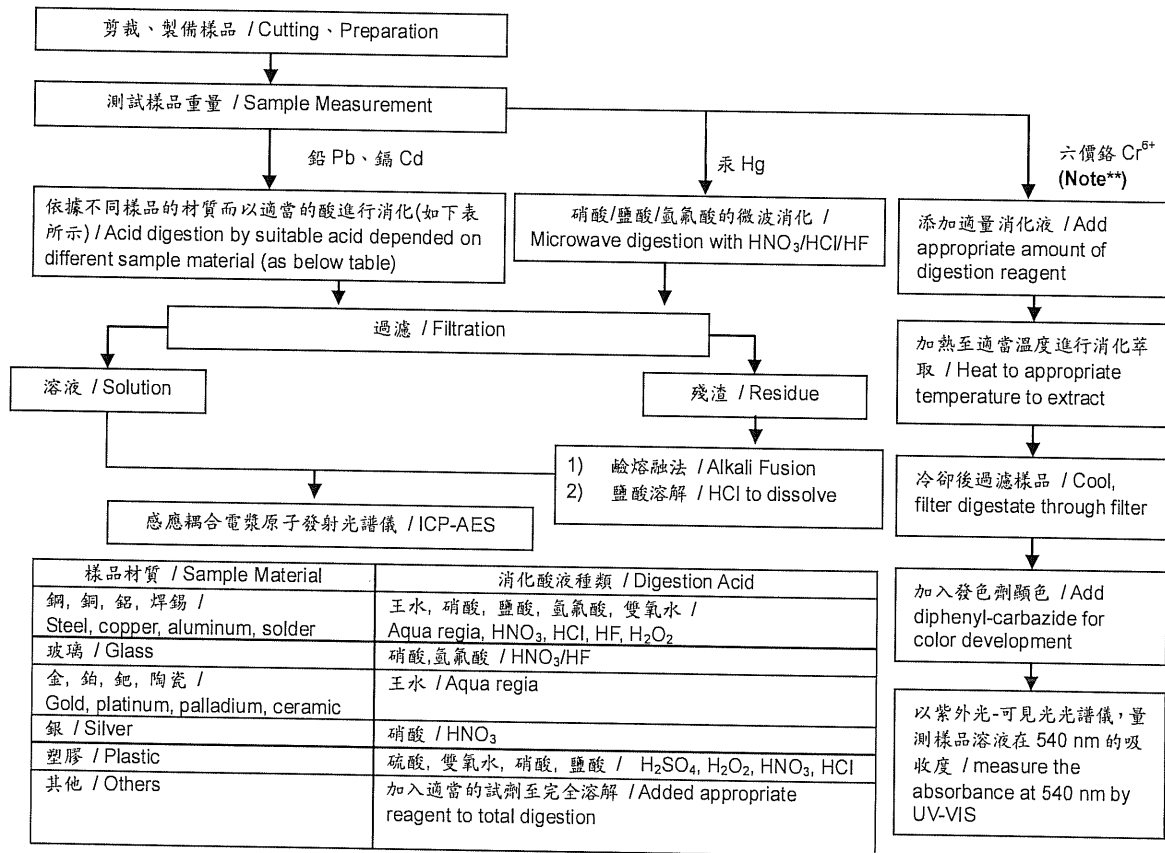

Note\*\*: (1) 針對非金屬材料加入鹼性消化液, 加熱至 90~95°C 萃取. / For non-metallic material, add alkaline digestion reagent and heat to 90~95°C.

(2) 針對金屬材料加入純水, 加熱至沸騰萃取. / For metallic material, add pure water and heat to boiling.

## 測試報告 Test Report

號碼(No.) : CE/2013/23406 日期(Date) : 2013/03/01 頁數(Page) : 6 of 8

西北臺慶科技股份有限公司 / TAI-TECH ADVANCED ELECTRONICS CO., LTD.

(東莞臺慶精密電子有限公司 / TAI-TECH ADVANCED ELECTRONICS (DONGGUAN) CO. LTD.)

(臺慶精密電子(昆山)有限公司 / TAI-TECH ADVANCED ELECTRONICS (KUN-SHAN) CO.

桃園縣楊梅市幼獅工業區幼四路1之1號 (NO. 1, YOU 4TH ROAD, YOUTH INDUSTRIAL DISTRICT, YANG-MEI CITY, TAO-YUAN HSIEN, TAIWAN R. O. C.)

(廣東省東莞市黃江鎮黃牛埔福祥街2號 / NO. 2, FUXIANG STREET, HUANGNIUPU, HUANGJIANG TOWN, DONGGUAN, GUANGDONG)

(江蘇省昆山市蓬朗昆嘉高科技工業區郭澤路 / GUO-ZE ROAD, KUNJIA HI-TECH INDUSTRIAL PARK, KUN-SHAN, JIANG-SU, CHINA)



### 多溴聯苯/多溴聯苯醚分析流程圖 / PBB/PBDE analytical FLOW CHART

- 測試人員：翁賜彬 / Name of the person who made measurement: Roman Wong
  - 測試負責人：張啓興 / Name of the person in charge of measurement: Troy Chang
- 初次測試程序 / First testing process —————>
- 選擇性篩檢程序 / Optional screen process .....>
- 確認程序 / Confirmation process - - ->

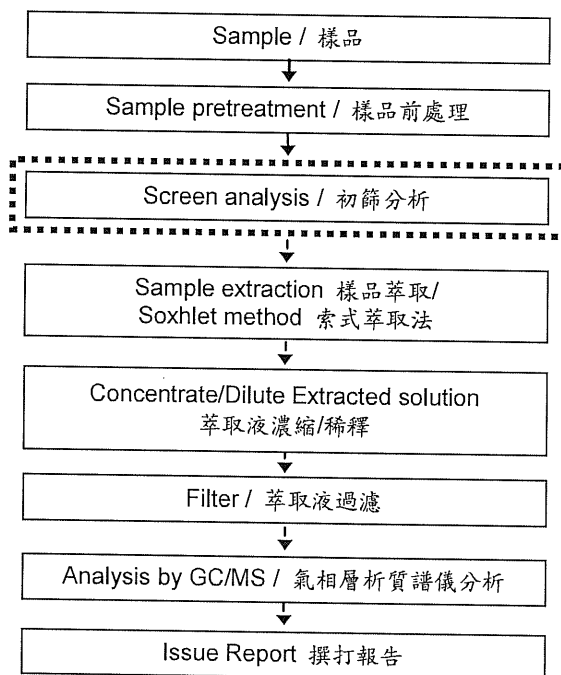

This document is issued by the Company subject to its General Conditions of Service printed overleaf, available on request or accessible at <http://www.sgs.com/en/Terms-and-Conditions/conditions.aspx> and, for electronic format documents, subject to Terms and Conditions for Electronic Documents at <http://www.sgs.com/en/Terms-and-Conditions/Terms-Document.aspx>. Attention is drawn to the limitation of liability, indemnification and jurisdiction issues defined therein. Any holder of this document is advised that information contained hereon reflects the Company's findings at the time of its intervention only and within the limits of client's instruction, if any. The Company's sole responsibility is to its Client and this document does not exonerate parties to a transaction from exercising all their rights and obligations under the transaction documents. This document cannot be reproduced, except in full, without prior written approval of the Company. Any unauthorized alteration, forgery or falsification of the content or appearance of this document is unlawful and offenders may be prosecuted to the fullest extent of the law. Unless otherwise stated the results shown in this test report refer only to the sample(s) tested.

# 測試報告 Test Report

號碼(No.) : CE/2013/23406 日期(Date) : 2013/03/01 頁數(Page) : 7 of 8



西北臺慶科技股份有限公司 / TAI-TECH ADVANCED ELECTRONICS CO., LTD.  
 (東莞臺慶精密電子有限公司 / TAI-TECH ADVANCED ELECTRONICS (DONGGUAN) CO. LTD.)  
 (臺慶精密電子(昆山)有限公司 / TAI-TECH ADVANCED ELECTRONICS (KUN-SHAN) CO.  
 桃園縣楊梅市幼獅工業區幼四路1之1號 (NO. 1, YOU 4TH ROAD, YOUTH INDUSTRIAL DISTRICT, YANG-MEI CITY, TAO-YUAN  
 HSIEN, TAIWAN R. O. C.)  
 (廣東省東莞市黃江鎮黃牛埔福祥街2號 / NO. 2, FUXIANG STREET, HUANGNIUPU, HUANGJIANG TOWN, DONGGUAN, GUANGDONG)  
 (江蘇省昆山市蓬朗昆嘉高科技工業區郭澤路 / GUO-ZE ROAD, KUNJIA HI-TECH INDUSTRIAL PARK, KUN-SHAN, JIANG-SU,  
 CHINA)

## 鹵素分析流程圖 / Analytical flow chart of halogen content

- 測試人員：陳恩臻 / Name of the person who made measurement: Rita Chen
- 測試負責人：張啓興 / Name of the person in charge of measurement: Troy Chang

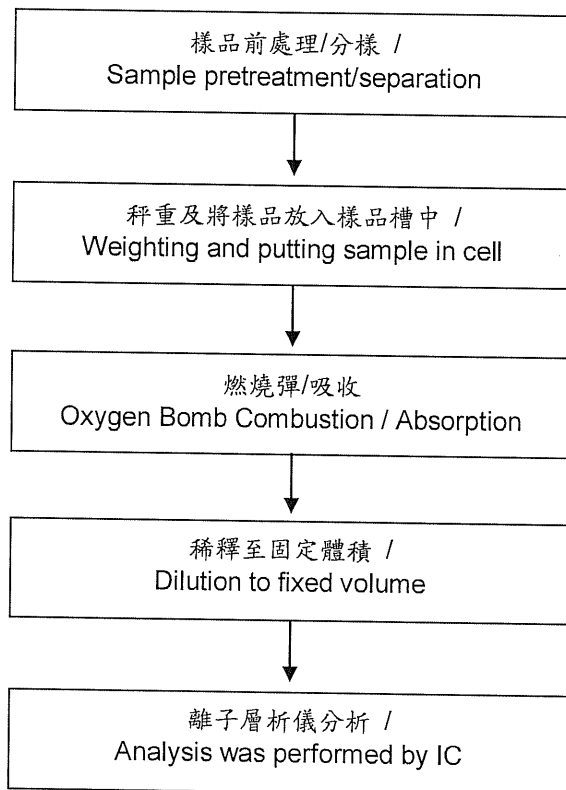

This document is issued by the Company subject to its General Conditions of Service printed overleaf, available on request or accessible at <http://www.sgs.com.tw/TermsandConditions.aspx> and, for electronic format documents, subject to Terms and Conditions for Electronic Documents at <http://www.sgs.com.tw/TermsandConditions/LicenseDocument.aspx>. Attention is drawn to the limitation of liability, indemnification and jurisdiction issues defined therein. Any holder of this document is advised that information contained hereon reflects the Company's findings at the time of its intervention only and within the limits of client's instruction, if any. The Company's sole responsibility is to its Client and this document does not exonerate parties to a transaction from exercising all their rights and obligations under the transaction documents. This document cannot be reproduced, except in full, without prior written approval of the Company. Any unauthorized alteration, forgery or falsification of the content or appearance of this document is unlawful and offenders may be prosecuted to the fullest extent of the law. Unless otherwise stated the results shown in this test report refer only to the sample(s) tested.

## 測試報告 Test Report

號碼(No.) : CE/2013/23406 日期(Date) : 2013/03/01 頁數(Page) : 8 of 8

西北臺慶科技股份有限公司 / TAI-TECH ADVANCED ELECTRONICS CO., LTD.

(東莞臺慶精密電子有限公司 / TAI-TECH ADVANCED ELECTRONICS (DONGGUAN) CO. LTD.)

(臺慶精密電子(昆山)有限公司 / TAI-TECH ADVANCED ELECTRONICS (KUN-SHAN) CO.

桃園縣楊梅市幼獅工業區幼四路1之1號 (NO. 1, YOU 4TH ROAD, YOUTH INDUSTRIAL DISTRICT, YANG-MEI CITY, TAO-YUAN HSIEN, TAIWAN R. O. C.)

(廣東省東莞市黃江鎮黃牛埔福祥街2號 / NO. 2, FUXIANG STREET, HUANGNIUPU, HUANGJIANG TOWN, DONGGUAN, GUANGDONG)

(江蘇省昆山市蓬朗昆嘉高科技工業區郭澤路 / GUO-ZE ROAD, KUNJIA HI-TECH INDUSTRIAL PARK, KUN-SHAN, JIANG-SU, CHINA)

\* 照片中如有箭頭標示，則表示為實際檢測之樣品/部位。\*

(The tested sample / part is marked by an arrow if it's shown on the photo.)

### CE/2013/23406

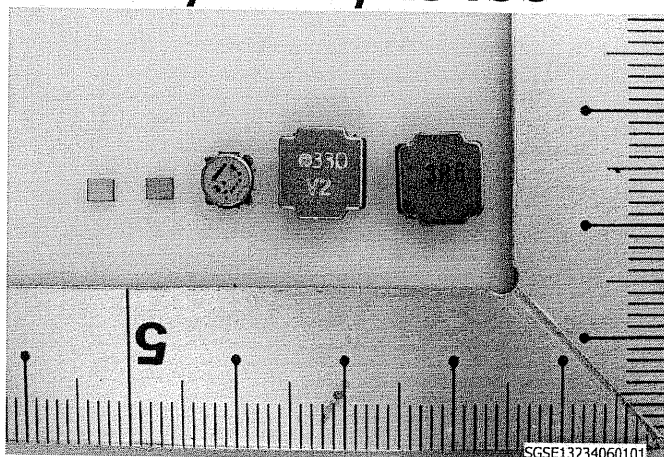

### CE/2013/23406

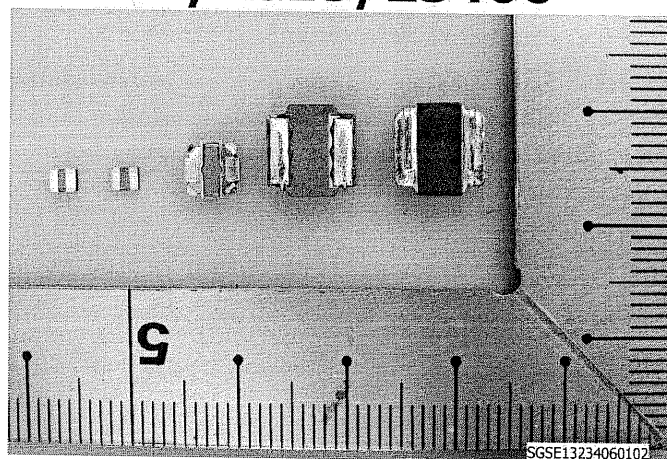

\*\* 報告結尾(End of Report) \*\*

This document is issued by the Company subject to its General Conditions of Service printed overleaf, available on request or accessible at <http://www.sgs.com/en/Terms-and-Conditions.aspx> and, for electronic format documents, subject to Terms and Conditions for Electronic Documents at <http://www.sgs.com/en/Terms-and-Conditions/Terms-Document.aspx>. Attention is drawn to the limitation of liability, indemnification and jurisdiction issues defined therein. Any holder of this document is advised that information contained hereon reflects the Company's findings at the time of its intervention only and within the limits of client's instruction, if any. The Company's sole responsibility is to its Client and this document does not exonerate parties to a transaction from exercising all their rights and obligations under the transaction documents. This document cannot be reproduced, except in full, without prior written approval of the Company. Any unauthorized alteration, forgery or falsification of the content or appearance of this document is unlawful and offenders may be prosecuted to the fullest extent of the law. Unless otherwise stated the results shown in this test report refer only to the sample(s) tested.



## X-ON Electronics

Largest Supplier of Electrical and Electronic Components

*Click to view similar products for [Fixed Inductors](#) category:*

*Click to view products by [Tai-Tech](#) manufacturer:*

Other Similar products are found below :

[CR32NP-100KC](#) [CR54NP-470LC](#) [70F224AI](#) [MGDQ4-00004-P](#) [MHQ1005P10NJ](#) [MHQ1005P1N0S](#) [MHQ1005P2N4S](#) [MHQ1005P3N6S](#)  
[MHQ1005P5N1S](#) [MHQ1005P8N2J](#) [PE-53601NL](#) [PE-53602NL](#) [PG0936.113NLT](#) [9220-20](#) [9310-16](#) [PM06-2N7](#) [PM06-39NJ](#) [A01TK](#)  
[1206CS-471XJ](#) [HC2-R47-R](#) [HC8-1R2-R](#) [HCF1305-3R3-R](#) [1206CS-151XG](#) [RCH664NP-140L](#) [RCH664NP-4R7M](#) [RCP1317NP-391L](#)  
[RCR110DNP-331L](#) [DH2280-4R7M](#) [DS1608C-106](#) [B10TJ](#) [B82498B3101J000](#) [ELJ-RE27NJF2](#) [1812CS-153XJ](#) [1812CS-183XJ](#) [1812CS-](#)  
[223XJ](#) [1812LS-104XJ](#) [1812LS-105XJ](#) [1812LS-124XJ](#) [1812LS-154XJ](#) [1812LS-223XJ](#) [1812LS-224XJ](#) [1812LS-563XJ](#) [1812LS-683XJ](#)  
[1812LS-824XJ](#) [NIN-FB101JTR110F](#) [NIN-FB471JTR62F](#) [NIN-FC1R5JTR220F](#) [NIN-HCR15JTRF](#) [NIN-HCR33JTRF](#) [NIN-HDR22JTRF](#)