

Specification for Approval

Date: 2021/12/21

Customer : 立创

TAI-TECH P/N: WCM3216F2SF-102T03

CUSTOMER P/N: _____

DESCRIPTION: _____

QUANTITY: _____

REMARK:	
Customer Approval Feedback	

西北臺慶科技股份有限公司
TAI-TECH Advanced Electronics Co., Ltd

- 代理商:
- 深圳市天诚科技有限公司
 Shenzhen TsaSun Technology Co., Ltd.
 Room 209, 2/F, Block A, Tengfei Industrial Building, No.6,
 Taohua Road, Futian District, Shenzhen
 TEL: 0755-8335 8885 / 0755-8335 9885
 E-mail: sales@tsasun.com
 www.tsacoil.com

Sales Dep.

APPROVED	CHECKED
夏晓曼	夏晓曼

- 西北臺慶科技股份有限公司
 TAI-TECH Advanced Electronics Co., Ltd
Headquarter:
 NO.1 YOU 4TH ROAD, YOUTH INDUSTRIAL DISTRICT, YANG-MEI,
 TAO-YUAN HSIEN, TAIWAN, R.O.C.
 TEL: +886-3-4641148 FAX: +886-3-4643565
 http://www.tai-tech.com.tw
 E-mail: sales@tai-tech.com.tw
- 臺慶精密電子(昆山)有限公司
 TAI-TECH ADVANCED ELECTRONICS(KUNSHAN) CO., LTD
 SHINWHA ROAD, KUNJIA HI-TECH INDUSTRIAL PARK, KUN-SHAN,
 JIANG-SU, CHINA
 TEL: +86-512-57619396 FAX: +86-512-57619688
 E-mail: hui@tai-tech.com.tw

R&D Center

APPROVED	CHECKED	DRAWN
羅宜春	梁周虎	卜文娟

Wire Wound Type Common Mode Filter

WCM3216F2SF-102T03

1. Features

1. High common mode impedance at high frequency effects excellent noise suppression performance.
2. WCM3216F2SF series realizes small size and low profile. 3.2x1.6x2.0 mm.
3. 100% Lead(Pb) & Halogen-Free and RoHS compliant.



2. Dimension

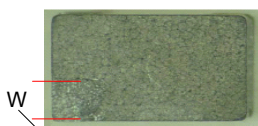
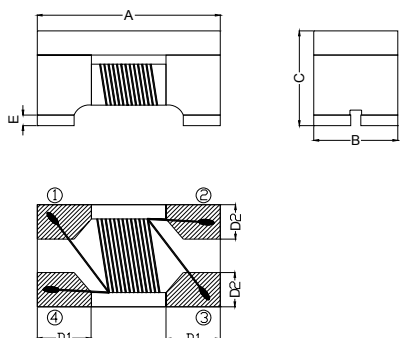

當破損面積 < 0.3mm², 產品列入允收品範圍

產品破損寬度

Series	A(mm)	B(mm)	C(mm)	D1(mm)	D2(mm)	E(mm)
3216F2SF	3.2±0.2	1.6±0.2	2.0±0.2	0.5±0.1	0.5±0.1	0.15±0.1

Units: mm

3. Part Numbering



- A: Series
- B: Dimension
- C: Material Ferrite Core
- D: Number of Lines 2=2 lines
- E: Type S=Shielded , N=Unshielded
- F: Lead free type
- G: Impedance 102=1000Ω
- H: Packaging T=Taping and Reel
- I: Rated Current 03=300mA

4. Specification

TAI-TECH Part Number	Common mode Impedance (Ω)	Test Frequency (MHz)	DC Resistance (Ω) max.	Rated Current (mA)max.	Rated Volt. (Vdc)max.	Withstand Volt. (Vdc) Max.	IR (Ω) min.
WCM3216F2SF-102T03	1000±25%	100	1.00	300	50	125	10M

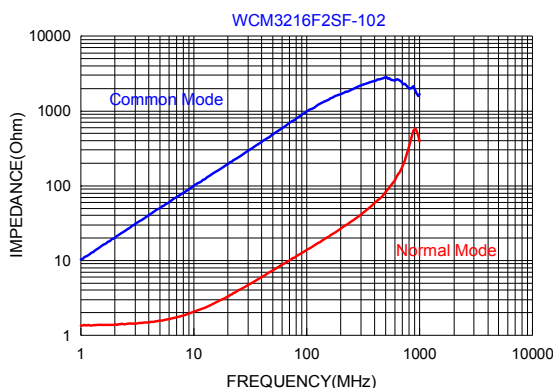

5. Schematic Diagram

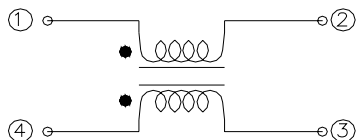

6. Materials

No.	Description	Specification
a.	Type	Shielded
b.	Core	Ferrite Core
c.	Termination	Tin Pb Free
d.	Wire	Enameled Copper Wire

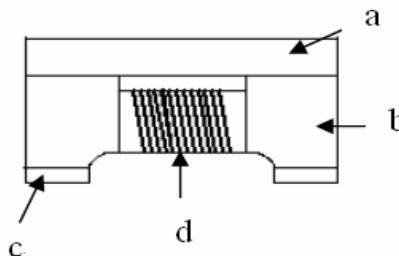

7. Reliability and Test Condition

Item	Performance	Test Condition										
Electrical Characteristics Test												
Z(common mode)	Refer to standard electrical characteristics list.	Agilent-4291A+ Agilent -16197A										
DCR		Agilent-4338B										
I.R.		Agilent4339										
Operating Temperature	-40°C~+85°C											
Storage Temperature	-40°C~+85°C (For products in unopened tape package, less than 40°C)											
Temperature Rise Test	Rated Current < 1A ΔT 20°C Max Rated Current ≥ 1A ΔT 40°C Max	1. Applied the allowed DC current. 2. Temperature measured by digital surface thermometer										
Mechanical Performance Test												
Solderability Test ANSI /J-STD-002	More than 95% of terminal electrode should be covered with solder.	<p>After fluxing, component shall be dipped in a melted solder bath at 235±5°C for 4±1 seconds.</p>										
Solder Heat Resistance MIL-STD-202 Method210	1.Components should have not evidence of electrical and mechanical damage. 2. Impedance: within ±30% of initial value.	<p>Preheat: 150°C 60secs. Solder: Sn-Cu0.5 Solder temperature: 260±5°C Flux: ROL0 Dip time: 10±0.5 secs.</p>										
Component Adhesion (Push test)	<table border="1"> <thead> <tr> <th>Series No.</th> <th>F(Kg)</th> </tr> </thead> <tbody> <tr> <td>WCM3216F2S</td> <td>0.8(min.)</td> </tr> <tr> <td>WCM2012F2S</td> <td>0.5(min.)</td> </tr> <tr> <td>WCM3216F2N</td> <td>0.8(min.)</td> </tr> <tr> <td>WCM2012F2N</td> <td>0.5(min.)</td> </tr> </tbody> </table>	Series No.	F(Kg)	WCM3216F2S	0.8(min.)	WCM2012F2S	0.5(min.)	WCM3216F2N	0.8(min.)	WCM2012F2N	0.5(min.)	<p>The device should be reflow soldered(255±5°C for 10sec.) to a tinned copper substrate. A dynamometer force gauge should be applied the side of the component. The device must with-ST-F Kg without ailure of the termination attached to component.</p>
Series No.	F(Kg)											
WCM3216F2S	0.8(min.)											
WCM2012F2S	0.5(min.)											
WCM3216F2N	0.8(min.)											
WCM2012F2N	0.5(min.)											

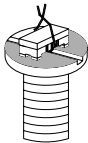
Item	Performance		Test Condition															
Component Adhesion (Pull test)	Series No.	F(Kg)	1.Insert 10cm wire into the remaining open eye bend ,the ends of even wire lengths upward and wind together. 2.Terminal shall not be remarkably damaged. 															
	WCM3216F2S	0.8(min.)																
	WCM2012F2S	0.5(min.)																
	WCM3216F2N	0.8(min.)																
	WCM2012F2N	0.5(min.)																
Reliability Test																		
High Temperature Life Test MIL-STD-202 METHOD 108	1. Appearance:No damage. 2. Impedance:within ±30% of initial value. No disconnection or short circuit.		Rated Current 100% Temperature:85±2 C . Duration:500±8hrs. Measured at room temperature after placing for 2 to 3hrs.															
Low Temperature Life Test JESD22-A119			Temperature:-40±2°C Time: 500±8hr. Recovery: 4 to 24hrs of recovery under the standard condition after the removal from test chamber.															
Thermal shock (Unload Test) MIL-STD-202 METHOD 107			<table border="1"> <thead> <tr> <th>Step</th> <th>Temperature(°C)</th> <th>Times(min.)</th> </tr> </thead> <tbody> <tr> <td>1</td> <td>-55±2</td> <td>30±3</td> </tr> <tr> <td>2</td> <td>Room Temp.</td> <td>5</td> </tr> <tr> <td>3</td> <td>85±2</td> <td>30±3</td> </tr> <tr> <td>4</td> <td>Room Temp.</td> <td>5</td> </tr> </tbody> </table>	Step	Temperature(°C)	Times(min.)	1	-55±2	30±3	2	Room Temp.	5	3	85±2	30±3	4	Room Temp.	5
Step			Temperature(°C)	Times(min.)														
1			-55±2	30±3														
2	Room Temp.	5																
3	85±2	30±3																
4	Room Temp.	5																
Humidity Resistance Test MIL-STD-202 METHOD 103	Condition for 1 cycle Step1:- 55±2°C 30±3 min. Step2:Room temperature 5 min. Step3: 85±2°C 30±3 min. Step4: Room temperature 5 min. Number of cycles:100																	
Random Vibration Test MIL-STD-202 Method 204	Frequency: 10-55-10Hz for 15 min. Amplitude: 1.52mm Directions and times: X, Y, Z directions for 15 min. This cycle shall be performed 12 times in each of three mutually perpendicular directions (Total 9hours).																	

8. Soldering and Mounting

8-1. Recommended PC Board Pattern

	WCM2012F2S/F2N	WCM3216F2S/F2N
L	2.60	3.70
H	1.25	1.60
G1	1.10	1.90
G2	0.45	0.40

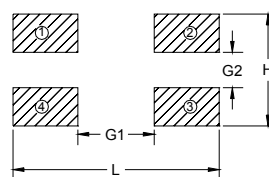

PC board should be designed so that products can prevent damage from mechanical stress when warping the board. Products shall be positioned in the sideways direction to against the mechanical stress to prevent failure.

8-2. Soldering

Mildly activated rosin fluxes are preferred. TAI-TECH terminations are suitable for all wave and re-flow soldering systems. If hand soldering cannot be avoided, the preferred technique is the utilization of hot air soldering tools.

8-2.1 Lead Free Solder re-flow:

Recommended temperature profiles for re-flow soldering in Figure 1.

8-2.2 Soldering Iron(Figure 2):

Products attachment with a soldering iron is discouraged due to the inherent process control limitations. In the event that a soldering iron must be employed the following precautions are recommended.

- Preheat circuit and products to 150°C
- Never contact the ceramic with the iron tip
- Use a 20 watt soldering iron with tip diameter of 1.0mm
- 355°C tip temperature (max)
- 1.0mm tip diameter (max)
- Limit soldering time to 4~5 sec.

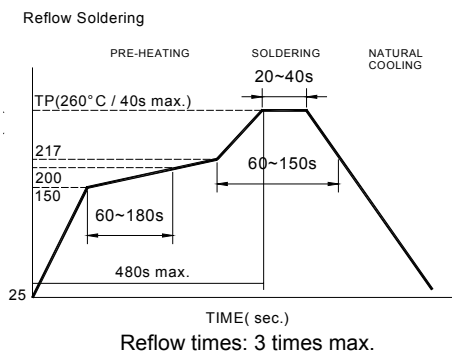

Fig.1

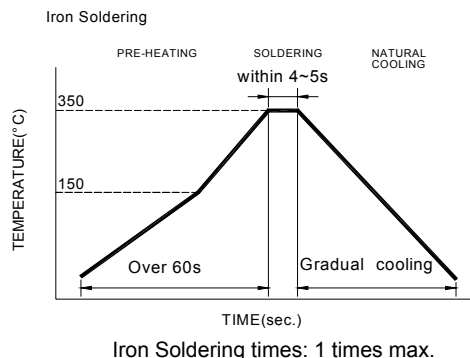
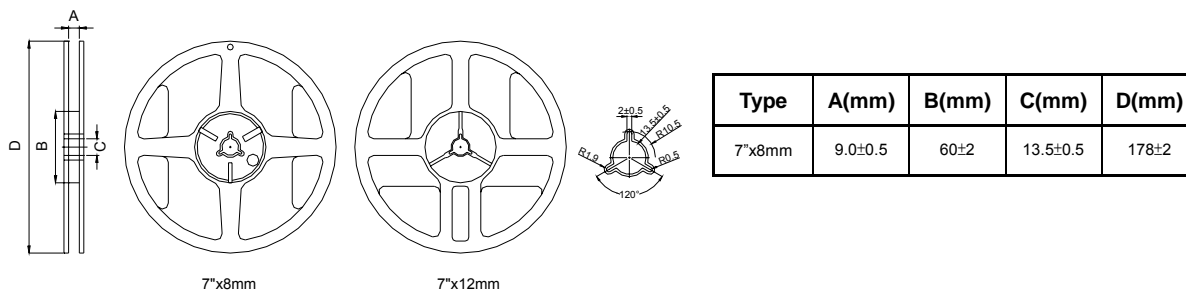

Fig.2

9. Packaging Information

9-1. Reel Dimension



9-2. Tape Dimension / 8mm

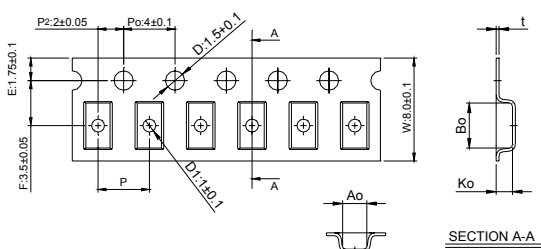

Series	size	Bo(mm)	Ao(mm)	Ko(mm)	P(mm)	t(mm)
WCM2012F2S	201212	2.35±0.1	1.50±0.1	1.45±0.1	4.0±0.1	0.22±0.05
WCM3216F2S	321620	3.50±0.1	1.88±0.1	2.10±0.1	4.0±0.1	0.22±0.05
WCM2012F2N	201209	2.50±0.1	1.60±0.1	1.25±0.1	4.0±0.1	0.22±0.05
WCM3216F2N	321615	3.50±0.1	1.88±0.1	1.80±0.1	4.0±0.1	0.22±0.05

9-3. Packaging Quantity

Chip size	Chip/Reel	Inner Box	Middle Box	Carton
WCM2012F2S/F2N	2000/3000	10000/15000	50000/75000	100000/150000
WCM3216F2S/F2N	2000	10000	50000	100000

9-4. Tearing Off Force

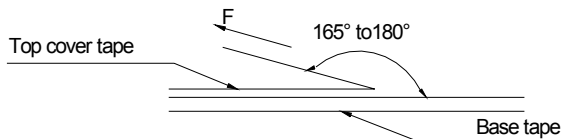

The force for tearing off cover tape is 15 to 80 grams in the arrow direction under the following conditions.

Room Temp. (°C)	Room Humidity (%)	Room atm (hPa)	Tearing Speed mm/min
5~35	45~85	860~1060	300

Application Notice

- Storage Conditions
 - To maintain the solderability of terminal electrodes:
 1. TAI-TECH products meet IPC/JEDEC J-STD-020D standard-MSL, level 1.
 2. Temperature and humidity conditions: Less than 40°C and 60% RH.
 3. Recommended products should be used within 12 months form the time of delivery.
 4. The packaging material should be kept where no chlorine or sulfur exists in the air.
- Transportation
 1. Products should be handled with care to avoid damage or contamination from perspiration and skin oils.
 2. The use of tweezers or vacuum pick up is strongly recommended for individual components.
 3. Bulk handling should ensure that abrasion and mechanical shock are minimized.

X-ON Electronics

Largest Supplier of Electrical and Electronic Components

Click to view similar products for [Common Mode Chokes / Filters](#) category:

Click to view products by [Tai-Tech](#) manufacturer:

Other Similar products are found below :

[PE-64683](#) [RD5122-6-9M6](#) [RD6137-6-7M5](#) [RD8147-16-3M0](#) [ST6118T-R](#) [FE3X025-10-7NL](#) [RD7147-25-0M7](#) [TCM0806G-350-2P-T](#)
[TCM0806G-650-2P-T](#) [IND-0110](#) [UAL21VR0802000](#) [UALSC023000000](#) [UALSC1020JH000](#) [UALSU10VD20010](#) [UALSU9VD070100](#) [36-00037](#) [UALW21HS072450](#) [UALSU9H0208000](#) [UAL24VK06450CH](#) [PLT10HH501100PNB](#) [PLT10HH401100PNB](#) [PLT10HH1026R0PNB](#)
[36-00029-01](#) [PE-67531](#) [TLH10UB](#) [113 0R5](#) [2752045447](#) [7351V](#) [CMF16-153131](#) [RD7147-6-6M0](#) [T8116NLT](#) [FE2X10-4-2NL](#) [36-00029-07](#)
[T8003NLT](#) [CTX01-13663](#) [CTX66-19521-R](#) [RC212-0.5-10M](#) [RC112-0.4-15M](#) [RC212-0.6-6M8](#) [RC212-0.4-15M](#) [RC112-0.3-30M](#)
[WTCF2012Z0M751PB](#) [PH9408.814NLT](#) [PAC6006.364NLT](#) [PAC6006.444NLT](#) [PAC6006.204NLT](#) [PH9407.204NLT](#) [PAC6006.264NLT](#)
[PH9408.105NLT](#) [PH9408.494NLT](#) [PAC6006.104NLT](#)