

Wire Wound Type Common Mode Filter

WCM4532F2SF-SERIES

1. Features

1. High common mode impedance at high frequency cause excellent noise suppression performance.
2. WCM4532F2SF series realizes small size and low profile. 4.5x3.2x2.8 mm.
3. 100% Lead(Pb) & Halogen-Free and RoHS compliant.
4. Operating temperature-40~+125°C (Including self - temperature rise)



2. Dimension

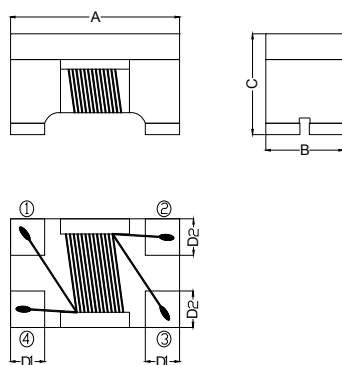

Recommended PC Board Pattern

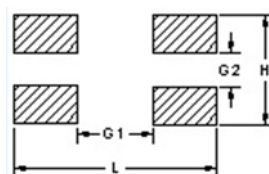

Series	A(mm)	B(mm)	C(mm)	D1(mm)	D2(mm)	L(mm)	H(mm)	G1(mm)	G2(mm)
4532F2SF	4.5±0.2	3.2±0.2	2.8±0.2	1.0±0.1	1.2±0.1	4.8	3.8	2.5	0.7

Units: mm

3. Part Numbering

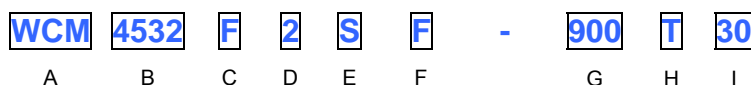

- A: Series
 B: Dimension
 C: Material Ferrite Core
 D: Number of Lines 2=2 lines
 E: Type S=Shielded , N=Unshielded
 F: Lead free
 G: Impedance 900=90Ω
 H: Packaging T=Taping and Reel
 I: Rated Current 30=3000mA

4. Specification

TAI-TECH Part Number	Common mode Impedance (Ω)	Test Frequency (MHz)	DC Resistance (Ω) max.	Rated Current (mA) max.	Rated Volt. (Vdc) max.	Withstand Volt. (Vdc) max.	IR (Ω) min.
WCM4532F2SF-800T30	80±25%	100	0.05	3000	50	125	10M
WCM4532F2SF-900T30	90±25%	100	0.05	3000	50	125	10M
WCM4532F2SF-121T30	120±25%	100	0.05	3000	50	125	10M
WCM4532F2SF-201T15	200±25%	100	0.10	1500	50	125	10M
WCM4532F2SF-601T15	600±25%	100	0.24	1500	50	125	10M
WCM4532F2SF-801T10	800±25%	100	0.24	1000	50	125	10M

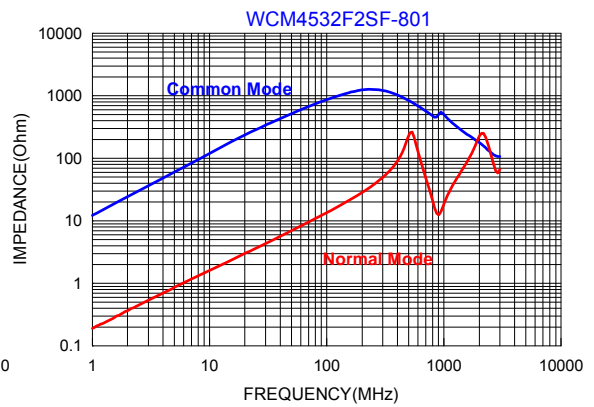
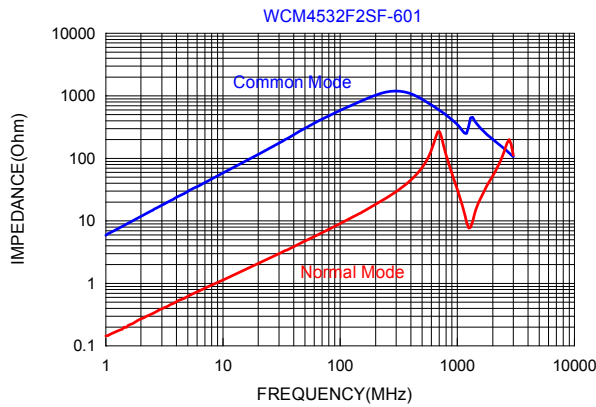
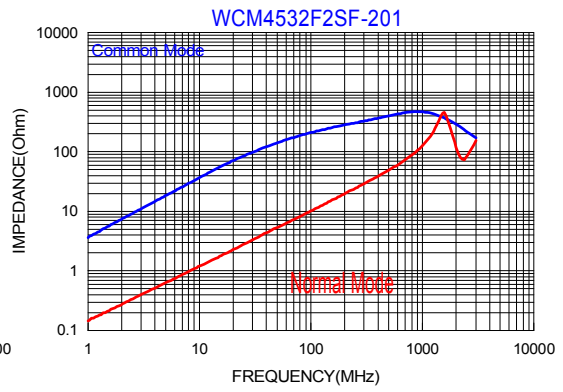
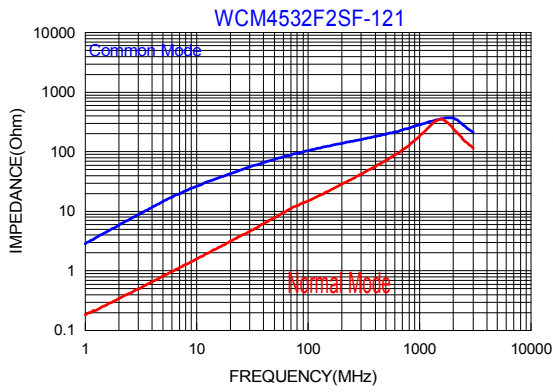
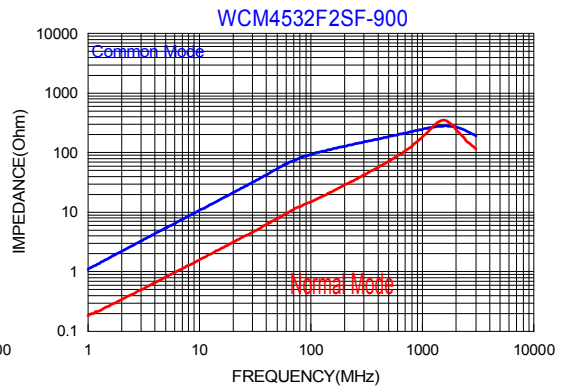
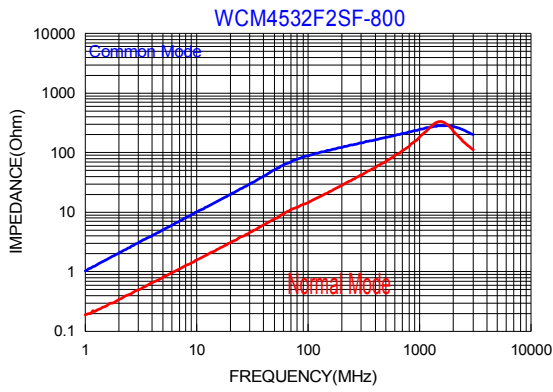

5. Schematic Diagram

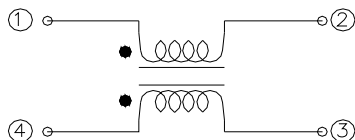

6. Materials

No.	Description	Specification
a.	Upper Plate	Ferrite
b.	Core	Ferrite Core
c.	Termination	Ag/Ni/Sn
d.	Wire	Enameled Copper Wire

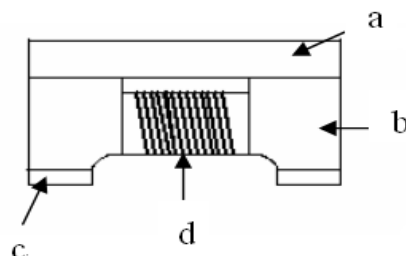

7. Reliability and Test Condition

Item	Performance	Test Condition
Operating temperature	-40~+125°C (Including self - temperature rise)	
Storage temperature	-40~+125°C (on board)	
Electrical Performance Test		
Z(common mode)	Refer to standard electrical characteristics list.	Agilent-4291A+ Agilent -16197A
DCR		Agilent-4338B
I.R.		Agilent4339
Temperature Rise Test	Rated Current < 1A ΔT 20°C Max Rated Current \geq 1A ΔT 40°C Max	1. Applied the allowed DC current. 2. Temperature measured by digital surface thermometer

Reliability Test		
Life Test		Preconditioning: Run through IR reflow for 2 times.(IPC/JEDEC J-STD-020DClassification Reflow Profiles) Temperature : 125±2°C Applied current : rated current Duration : 1000±12hrs Measured at room temperature after placing for 24±2 hrs
Load Humidity		Preconditioning: Run through IR reflow for 2 times.(IPC/JEDEC J-STD-020DClassification Reflow Profiles) Humidity : 85±2%R.H, Temperature : 85°C±2°C Duration : 1000hrs Min. with 100% rated current Measured at room temperature after placing for 24±2 hrs
Moisture Resistance	Appearance : No damage. Impedance : within±15% of initial value Inductance : within±10% of initial value Q : Shall not exceed the specification value. RDC : within ±15% of initial value and shall not exceed the specification value	Preconditioning: Run through IR reflow for 2 times.(IPC/JEDEC J-STD-020DClassification Reflow Profiles 1. Baked at 50°C for 25hrs, measured at room temperature after placing for 4 hrs. 2. Raise temperature to 65±2°C 90-100%RH in 2.5hrs, and keep 3 hours, cool down to 25°C in 2.5hrs. 3. Raise temperature to 65±2°C 90-100%RH in 2.5hrs, and keep 3 hours, cool down to 25°C in 2.5hrs,keep at 25°C for 2 hrs then keep at -10°C for 3 hrs 4. Keep at 25°C 80-100%RH for 15min and vibrate at the frequency of 10 to 55 Hz to 10 Hz, measure at room temperature after placing for 1~2 hrs.
Thermal shock		Preconditioning: Run through IR reflow for 2 times.(IPC/JEDEC J-STD-020DClassification Reflow Profiles Condition for 1 cycle Step1 : -40±2°C 30±5min Step2 : 25±2°C ≤0.5min Step3 : 125±2°C 30±5min Number of cycles : 500 Measured at room temperature after placing for 24±2 hrs
Vibration		Oscillation Frequency: 10 ~ 2K ~ 10Hz for 20 minutes Equipment : Vibration checker Total Amplitude:1.52mm±10% Testing Time : 12 hours(20 minutes, 12 cycles each of 3 orientations).

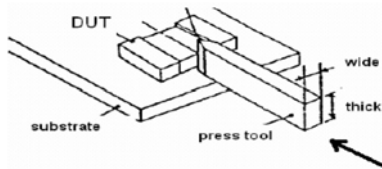
Item	Performance	Test Condition															
Bending	Appearance : No damage. Impedance : within±15% of initial value Inductance : within±10% of initial value Q : Shall not exceed the specification value. RDC : within ±15% of initial value and shall not exceed the specification value	Shall be mounted on a FR4 substrate of the following dimensions: >=0805 inch(2012mm):40x100x1.2mm <0805 inch(2012mm):40x100x0.8mm Bending depth: >=0805 inch(2012mm):1.2mm <0805 inch(2012mm):0.8mm duration of 10 sec.															
Shock	Appearance : No damage. Impedance : within±15% of initial value Inductance : within±10% of initial value Q : Shall not exceed the specification value. RDC : within ±15% of initial value and shall not exceed the specification value	<table border="1"> <thead> <tr> <th>Type</th> <th>Peak value (g's)</th> <th>Normal duration (D) (ms)</th> <th>Wave form</th> <th>Velocity change (V)ft/sec</th> </tr> </thead> <tbody> <tr> <td>SMD</td> <td>50</td> <td>11</td> <td>Half-sine</td> <td>11.3</td> </tr> <tr> <td>Lead</td> <td>50</td> <td>11</td> <td>Half-sine</td> <td>11.3</td> </tr> </tbody> </table>	Type	Peak value (g's)	Normal duration (D) (ms)	Wave form	Velocity change (V)ft/sec	SMD	50	11	Half-sine	11.3	Lead	50	11	Half-sine	11.3
Type	Peak value (g's)	Normal duration (D) (ms)	Wave form	Velocity change (V)ft/sec													
SMD	50	11	Half-sine	11.3													
Lead	50	11	Half-sine	11.3													
Solder ability	More than 95% of the terminal electrode should be covered with solder.	Preheat: 150°C ,60sec.。 Solder: Sn96.5% Ag3% Cu0.5% Temperature: 245±5°C 。 Flux for lead free: Rosin. 9.5% 。 Dip time: 4±1sec 。 Depth: completely cover the termination															
Resistance to Soldering Heat		Depth: completely cover the termination <table border="1"> <thead> <tr> <th>Temperature(°C)</th> <th>Time(s)</th> <th>Temperature ramp/immersion and emersion rate</th> <th>Number of heat cycles</th> </tr> </thead> <tbody> <tr> <td>260 ±5 (solder temp)</td> <td>10 ±1</td> <td>25mm/s ±6 mm/s</td> <td>1</td> </tr> </tbody> </table>	Temperature(°C)	Time(s)	Temperature ramp/immersion and emersion rate	Number of heat cycles	260 ±5 (solder temp)	10 ±1	25mm/s ±6 mm/s	1							
Temperature(°C)	Time(s)	Temperature ramp/immersion and emersion rate	Number of heat cycles														
260 ±5 (solder temp)	10 ±1	25mm/s ±6 mm/s	1														
Terminal Strength	Appearance : No damage. Impedance : within±15% of initial value Inductance : within±10% of initial value Q : Shall not exceed the specification value. RDC : within ±15% of initial value and shall not exceed the specification value e	Preconditioning: Run through IR reflow for 2 times.(IPC/JEDEC J-STD-020DClassification Reflow Profiles With the component mounted on a PCB with the device to be tested, apply a force(>0805:1kg , <=0805:0.5kg)to the side of a device being tested. This force shall be applied for 60 +1 seconds. Also the force shall be applied gradually as not to apply a shock to the component being tested. 															

8. Soldering and Mounting

8-1. Soldering

Mildly activated rosin fluxes are preferred. TAI-TECH terminations are suitable for all wave and re-flow soldering systems. If hand soldering cannot be avoided, the preferred technique is the utilization of hot air soldering tools.

8-1.1 Solder re-flow:

Recommended temperature profiles for re-flow soldering in Figure 1.

8-1.2 Soldering Iron(Figure 2):

Products attachment with a soldering iron is discouraged due to the inherent process control limitations. In the event that a soldering iron must be employed the following precautions are recommended.

- Preheat circuit and products to 150°C
- Never contact the ceramic with the iron tip
- Use a 20 watt soldering iron with tip diameter of 1.0mm
- 350°C tip temperature (max)
- 1.0mm tip diameter (max)
- Limit soldering time to 4~5 sec.

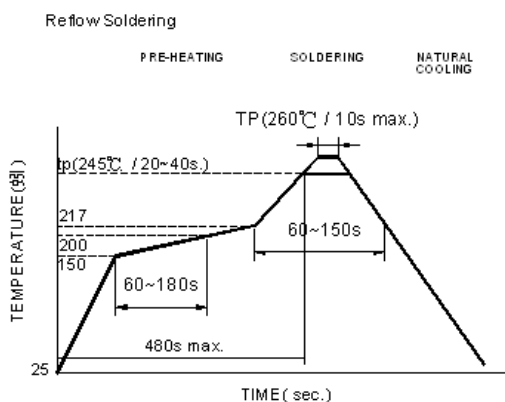

Reflow times: 3 times max.

Fig.1

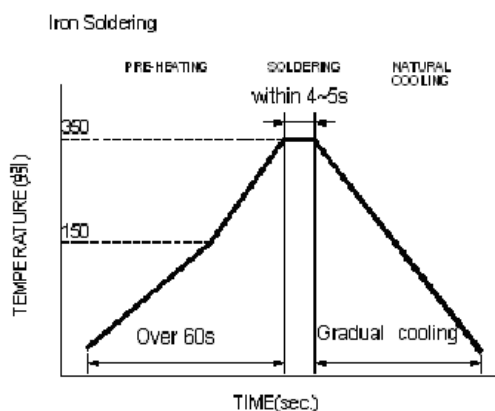

Iron Soldering times: 1 times max.

Fig.2

9. Packaging Information

9-1. Reel Dimension

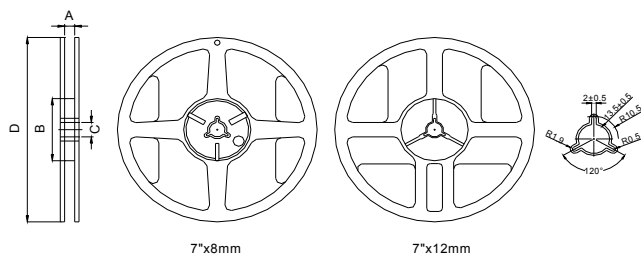

Type	A(mm)	B(mm)	C(mm)	D(mm)
7"x12mm	13.5±0.5	60±2	13.5±0.5	178±2

9-2. Tape Dimension / 12mm

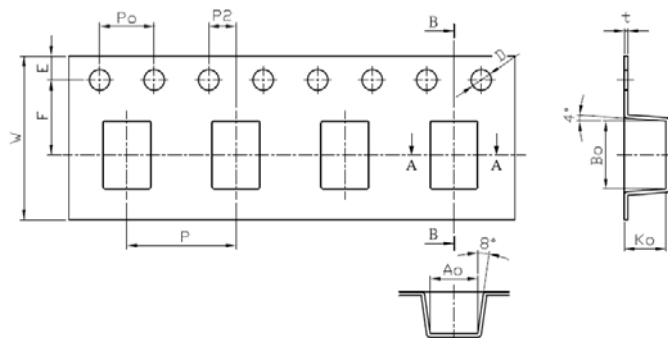

Series	P(mm)	Po(mm)	P2(mm)	Bo(mm)	Ao(mm)	Ko(mm)	D(mm)	E(mm)	F(mm)	W(mm)	t(mm)
WCM4532F2S	8.00±0.10	4.00±0.10	2.00±0.05	4.90±0.10	3.60±0.10	3.00±0.10	1.05+0.10/-0.00	1.75±0.10	5.50±0.05	12.00±0.10	0.26±0.05

9-3. Packaging Quantity

Chip size	Chip/Reel	Inner Box	Middle Box	Carton
WCM4532F2S	500	2000	10000	20000

9-4. Tearing Off Force

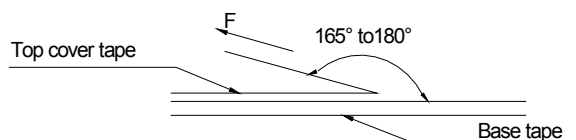

The force for tearing off cover tape is 15 to 80 grams in the arrow direction under the following conditions.

Room Temp. (°C)	Room Humidity (%)	Room atm (hPa)	Tearing Speed mm/min
5~35	45~85	860~1060	300

Application Notice

- Storage Conditions(component level)
 - To maintain the solderability of terminal electrodes:
 - TAI-TECH products meet IPC/JEDEC J-STD-020D standard-MSL, level 1.
 - Temperature and humidity conditions: Less than 40°C and 60% RH.
 - Recommended products should be used within 12 months form the time of delivery.
 - The packaging material should be kept where no chlorine or sulfur exists in the air.
- Transportation
 - Products should be handled with care to avoid damage or contamination from perspiration and skin oils.
 - The use of tweezers or vacuum pick up is strongly recommended for individual components.
 - Bulk handling should ensure that abrasion and mechanical shock are minimized.

X-ON Electronics

Largest Supplier of Electrical and Electronic Components

Click to view similar products for [Common Mode Chokes / Filters](#) category:

Click to view products by [Tai-Tech](#) manufacturer:

Other Similar products are found below :

[PE-64683](#) [RD5122-6-9M6](#) [RD6137-6-7M5](#) [RD8147-16-3M0](#) [ST6118T-R](#) [FE3X025-10-7NL](#) [RD7147-25-0M7](#) [TCM0806G-350-2P-T](#)
[TCM0806G-650-2P-T](#) [IND-0110](#) [UAL21VR0802000](#) [UALSC023000000](#) [UALSC1020JH000](#) [UALSU10VD20010](#) [UALSU9VD070100](#) [36-00037](#) [UALW21HS072450](#) [UALSU9H0208000](#) [UAL24VK06450CH](#) [PLT10HH501100PNB](#) [PLT10HH401100PNB](#) [PLT10HH1026R0PNB](#)
[36-00029-01](#) [PE-67531](#) [TLH10UB](#) [113 0R5](#) [2752045447](#) [7351V](#) [CMF16-153131](#) [RD7147-6-6M0](#) [T8116NLT](#) [FE2X10-4-2NL](#) [36-00029-07](#)
[T8003NLT](#) [CTX01-13663](#) [CTX66-19521-R](#) [RC212-0.5-10M](#) [RC112-0.4-15M](#) [RC212-0.6-6M8](#) [RC212-0.4-15M](#) [RC112-0.3-30M](#)
[WTCF2012Z0M751PB](#) [PH9408.814NLT](#) [PAC6006.364NLT](#) [PAC6006.444NLT](#) [PAC6006.204NLT](#) [PH9407.204NLT](#) [PAC6006.264NLT](#)
[PH9408.105NLT](#) [PH9408.494NLT](#) [PAC6006.104NLT](#)