

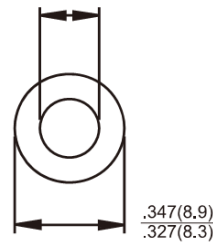

ARS50 SERIES 50 AMPS. High Current Button Rectifiers

ARS

.225(5.7)
.215(5.5)



.347(8.9)
.327(8.3)

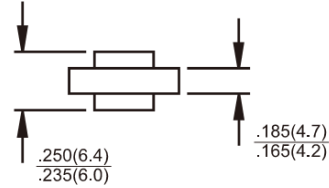

Dimensions in inches and (millimeters)

Marking Diagram

ARS50X = Specific Device Code

G = Green Compound

Y = Year

M = Work Month



Features

- ✧ Plastic material used carries Underwriters Laboratory Classification 94V-0
- ✧ Low cost construction utilizing void-free molded plastic technique
- ✧ Low cost
- ✧ Diffused junction
- ✧ Low leakage
- ✧ High surge capability
- ✧ High temperature soldering guaranteed: 260°C for 10 seconds
- ✧ Green compound with suffix "G" on packing code & prefix "G" on datecode

Mechanical Data

- ✧ Case: Molded plastic case
- ✧ Terminals: Pure tin plated, lead free, solderable per MIL-STD-202, Method 208
- ✧ Polarity: Color ring denotes cathode
- ✧ Weight: 1.8 grams
- ✧ Mounting position: Any

Maximum Ratings and Electrical Characteristics

Rating at 25 °C ambient temperature unless otherwise specified.

Single phase, half wave, 60 Hz, resistive or inductive load.

For capacitive load, derate current by 20%

Type Number	Symbol	ARS 50A	ARS 50B	ARS 50D	ARS 50G	ARS 50J	ARS 50K	ARS 50M	Units
Maximum Recurrent Peak Reverse Voltage	V_{RRM}	50	100	200	400	600	800	1000	V
Maximum RMS Voltage	V_{RMS}	35	70	140	280	420	560	700	V
Maximum DC Blocking Voltage	V_{DC}	50	100	200	400	600	800	1000	V
Maximum Average Forward Rectified Current @ $T_C=135^\circ C$	$I_{F(AV)}$	50							A
Peak Forward Surge Current, 8.3 ms Single Half Sine-wave Superimposed on Rated Load (JEDEC method) at $T_J=150^\circ C$	I_{FSM}	500							A
Maximum Instantaneous Forward Voltage (Note 1) @ 50A	V_F	1.1							V
Maximum DC Reverse Current at @ $T_A=25^\circ C$ Rated DC Blocking Voltage @ $T_A=125^\circ C$	I_R	5 250							μA μA
Typical Reverse Recovery Time (Note 2)	T_{rr}	3.0							μS
Typical Junction Capacitance (Note 3)	C_j	300							pF
Typical Thermal Resistance (Note 4)	$R_{\theta JC}$	1.0							$^\circ C/W$
Operating and Storage Temperature Range	T_J, T_{STG}	- 50 to + 175							$^\circ C$

Note 1: Pulse Test with PW=300 usec, 1% Duty Cycle

Note 2: Reverse Recovery Time Test Conditions: $I_F=0.5A$, $I_R=1.0A$, $I_{RR}=0.25A$

Note 3: Measured at 1 MHz and Applied Reverse Voltage of 4.0V D.C.

Note 4: Thermal Resistance from Junction to Case, Single Side Cooled.

RATINGS AND CHARACTERISTIC CURVES (ARS50 SERIES)

FIG.1- MAXIMUM FORWARD CURRENT DERATING CURVE

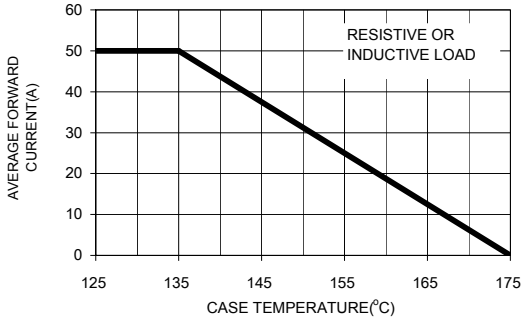

FIG. 2- TYPICAL REVERSE CHARACTERISTICS

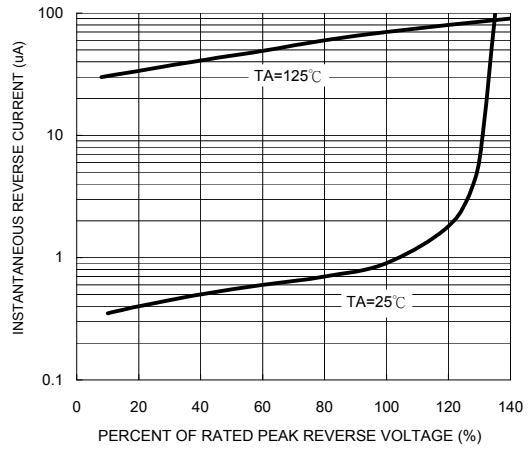

FIG. 3- MAXIMUM NON-REPETITIVE PEAK FORWARD SURGE CURRENT

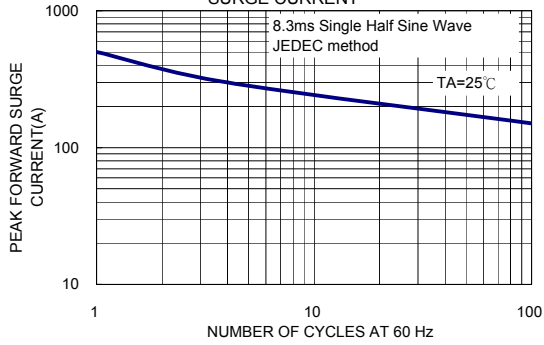

FIG. 5- TYPICAL FORWARD CHARACTERISTICS

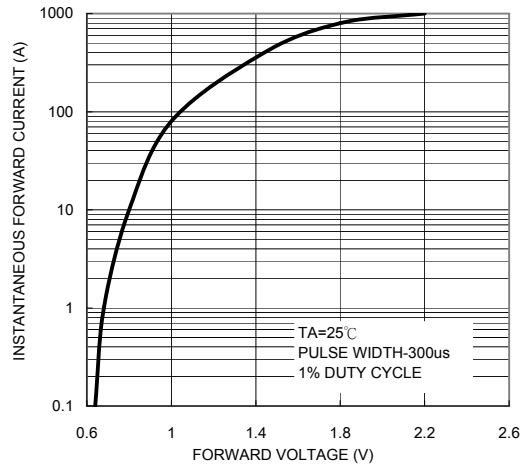

FIG. 4- TYPICAL JUNCTION CAPACITANCE

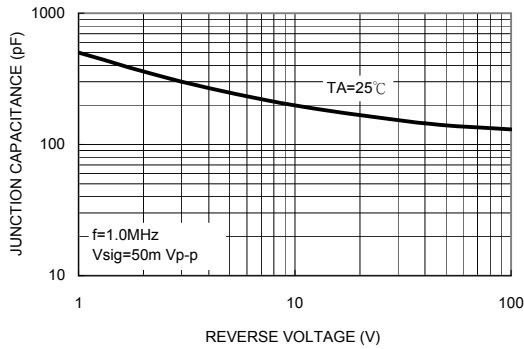
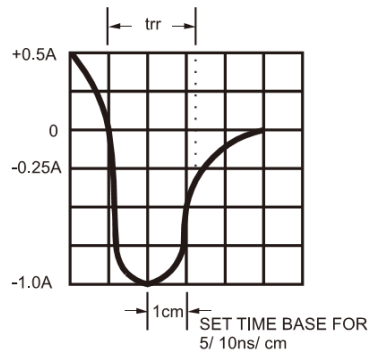
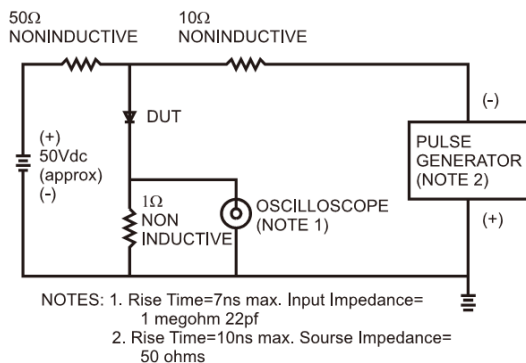

FIG.6- REVERSE RECOVERY TIME CHARACTERISTIC AND TEST CIRCUIT DIAGRAM



X-ON Electronics

Largest Supplier of Electrical and Electronic Components

Click to view similar products for [Rectifiers](#) category:

Click to view products by [Taiwan Semiconductor](#) manufacturer:

Other Similar products are found below :

[70HFR40](#) [RL252-TP](#) [150KR30A](#) [1N5397](#) [NTE5841](#) [NTE6038](#) [SCF5000](#) [1N4002G](#) [1N4005-TR](#) [JANS1N6640US](#) [481235F](#)
[RRE02VS6SGTR](#) [067907F](#) [MS306](#) [70HF40](#) [T110HF60](#) [T85HFL60S02](#) [US2JFL-TP](#) [A1N5404G-G](#) [CRS04\(T5L,TEMQ\)](#) [ACGRA4007-HF](#)
[ACGRB207-HF](#) [CLH03\(TE16L,Q\)](#) [ACGRC307-HF](#) [ACEFC304-HF](#) [NTE6356](#) [NTE6359](#) [NTE6002](#) [NTE6023](#) [NTE6039](#) [NTE6077](#)
[85HFR60](#) [40HFR60](#) [1N1186RA](#) [70HF120](#) [85HFR80](#) [D126A45C](#) [SCF7500](#) [D251N08B](#) [SCHJ22.5K](#) [SM100](#) [SCPA2](#) [SCH10000](#) [SDHD5K](#)
[VS-12FL100S10](#) [ACGRA4001-HF](#) [D1821SH45T PR](#) [D1251S45T](#) [NTE5990](#) [NTE6358](#)