

1.5A, 1000V Fast avalanche Surface Mount Rectifier

FEATURES

- Glass passivated junction chip
- Ideal for automated placement
- Fast switching for high efficiency
- High surge current capability
- Compliant to RoHS Directive 2011/65/EU and in accordance to WEEE 2002/96/EC
- Halogen-free according to IEC 61249-2-21



TYPICAL APPLICATION

The superior avalanche capability of BYG21M is specially suited for free-wheeling, clamping, snubber, demagnetization in power supplies and other power switching applications.

DO-214AC (SMA)

MECHANICAL DATA

Case: DO-214AC (SMA)

Molding compound: UL flammability classification rating 94V-0

Moisture sensitivity level (MSL): level 1, per J-STD-020

Part no. with suffix "H" means AEC-Q101 qualified

Packing code with suffix "G" means green compound (halogen-free)

Terminal: Matte tin plated leads, solderable per JESD22-B102

Meet JESD 201 class 2 whisker test

Polarity: Indicated by cathode band

Weight: 64 mg (approximately)

MAXIMUM RATINGS AND ELECTRICAL CHARACTERISTICS (T _A =25°C unless otherwise noted)			
PARAMETER	SYMBOL	BYG21M	UNIT
Maximum repetitive peak reverse voltage	V _{RRM}	1000	V
Maximum RMS voltage	V _{RMS}	700	V
Maximum DC blocking voltage	V _{DC}	1000	V
Maximum average forward rectified current	I _{F(AV)}	1.5	A
Peak forward surge current, 8.3 ms single half sine-wave superimposed on rated load	I _{FSM}	50	A
Maximum instantaneous forward voltage I _F =1A (Note 1)	V _F	1.5	V
I _F =1.5A		1.6	
Maximum reverse current @ Rated V _R	I _R	T _J =25°C	1
		T _J =100°C	10
		T _J =125°C	50
Pulse energy in avalanche mode, non repetitive (Inductive load switch off) T _A =25°C, I _{(BR)R} =1.23A	E _{RSM}	30	mJ
Maximum reverse recovery time (Note 2)	t _{rr}	120	ns
Typical junction capacitance (Note 3)	C _J	13	pF
Typical thermal resistance	R _{θJL}	20	°C/W
	R _{θJA}	70	
Operating junction temperature range	T _J	- 55 to +150	°C
Storage temperature range	T _{STG}	- 55 to +150	°C

Note 1: Pulse test with PW=300μs, 1% duty cycle

Note 2: Test conditions: I_F=0.5A, I_R=1.0A, I_{RR}=0.25A

Note 3: Measured at 1 MHz and applied reverse voltage of 4.0V

ORDERING INFORMATION					
PART NO.	PART NO. SUFFIX	PACKING CODE	PACKING CODE SUFFIX	PACKAGE	PACKING
BYG21M (Note 1)	H	R3	G	SMA	1,800 / 7" Plastic reel
		R2		SMA	7,500 / 13" Paper reel
		M2		SMA	7,500 / 13" Plastic reel
		F3		Folded SMA	1,800 / 7" Plastic reel
		F2		Folded SMA	7,500 / 13" Paper reel
		F4		Folded SMA	7,500 / 13" Plastic reel

Note 1: Whole series with green compound

EXAMPLE					
EXAMPLE PART NO.	PART NO.	PART NO. SUFFIX	PACKING CODE	PACKING CODE SUFFIX	DESCRIPTION
BYG21MHR3G	BYG21M	H	R3	G	AEC-Q101 qualified Green compound

RATINGS AND CHARACTERISTICS CURVES

($T_A=25^\circ\text{C}$ unless otherwise noted)

FIG. 1 MAXIMUM AVERAGE FORWARD CURRENT DERATING

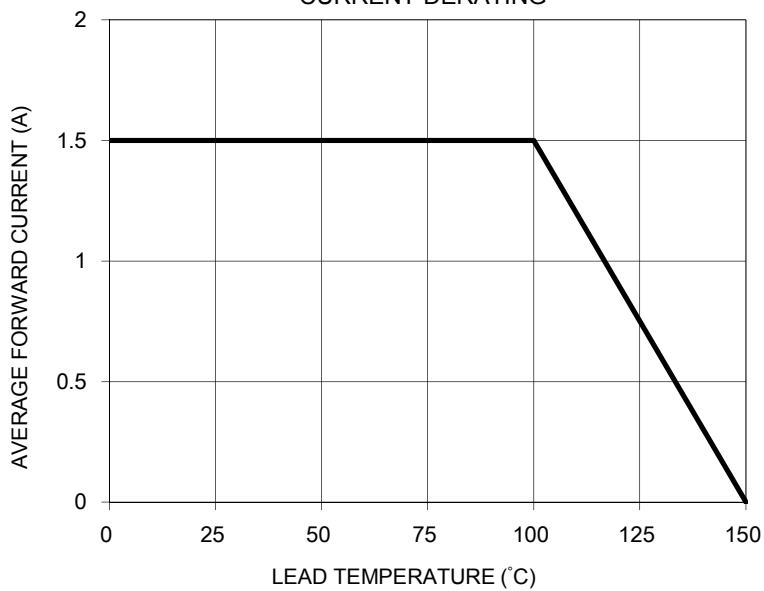

FIG. 2 TYPICAL REVERSE CHARACTERISTICS

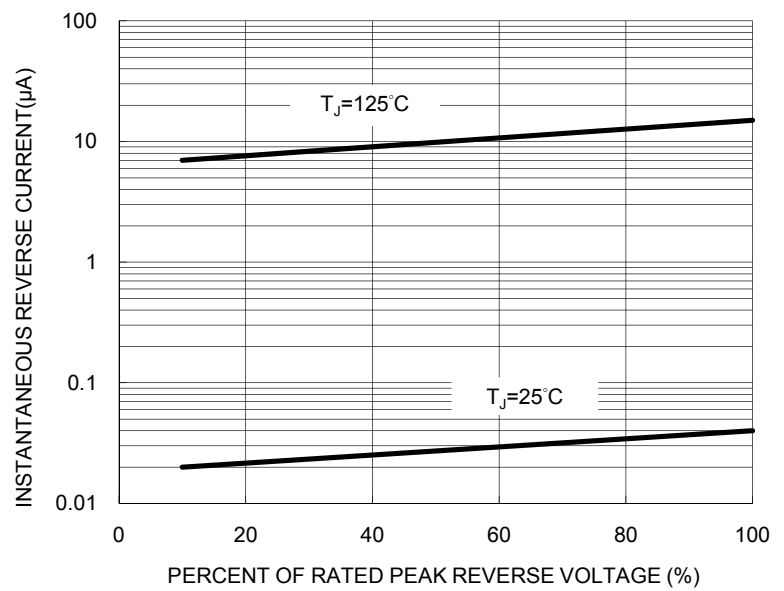

FIG. 3 MAXIMUM NON-REPETITIVE FORWARD SURGE CURRENT

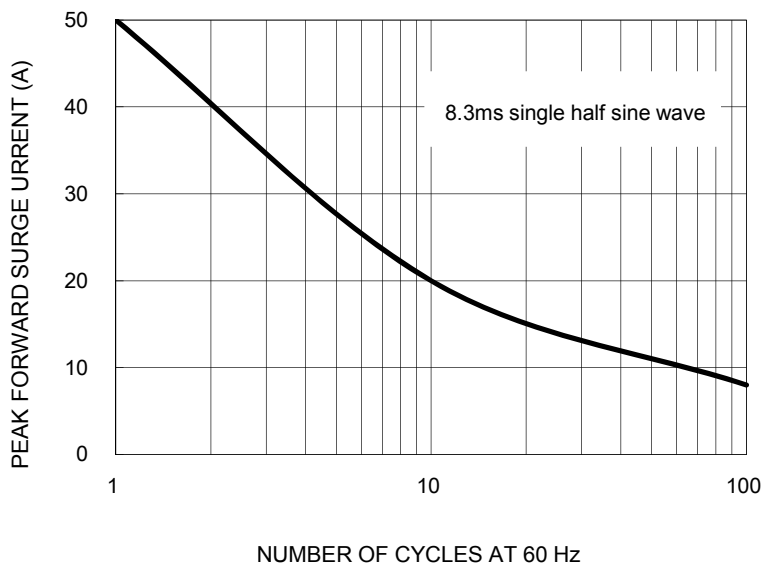

FIG. 4 TYPICAL JUNCTION CAPACITANCE

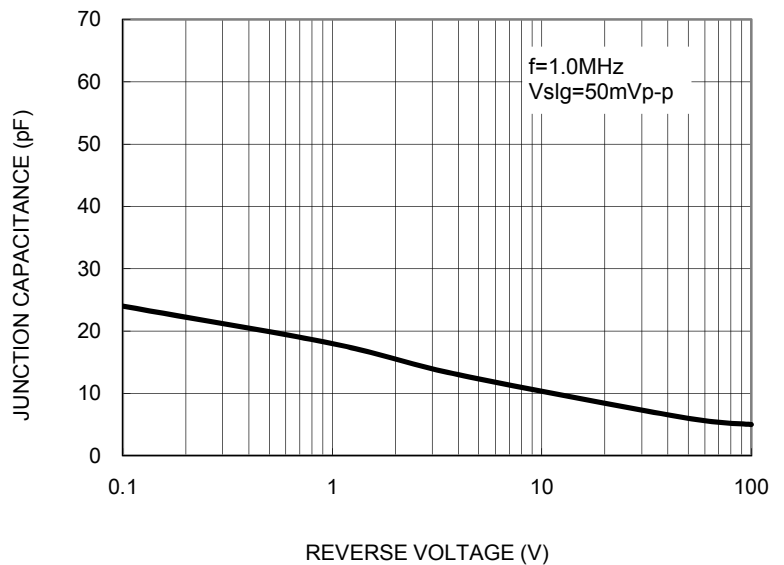
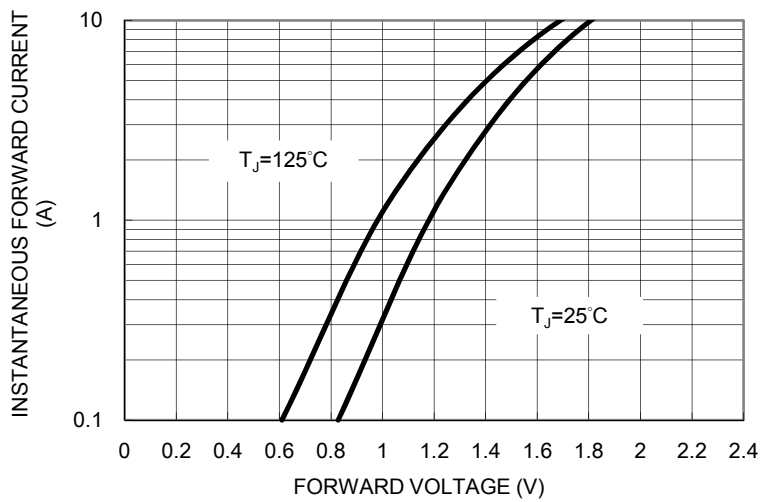
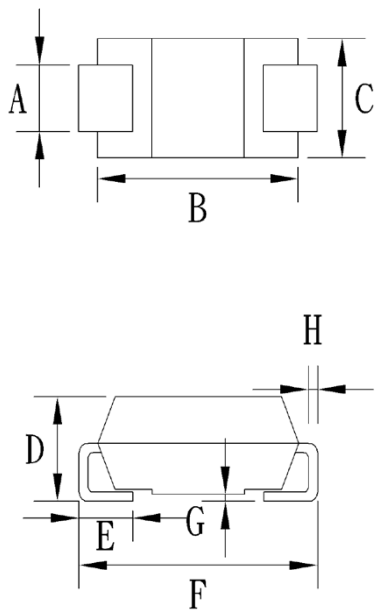

FIG. 5 TYPICAL INSTANTANEOUS FORWARD CHARACTERISTICS



PACKAGE OUTLINE DIMENSIONS

DO-214AC (SMA)



DIM.	Unit (mm)		Unit (inch)	
	Min	Max	Min	Max
A	1.27	1.58	0.050	0.062
B	4.06	4.60	0.160	0.181
C	2.29	2.83	0.090	0.111
D	1.99	2.50	0.078	0.098
E	0.90	1.41	0.035	0.056
F	4.95	5.33	0.195	0.210
G	0.10	0.20	0.004	0.008
H	0.15	0.31	0.006	0.012

SUGGESTED PAD LAYOUT

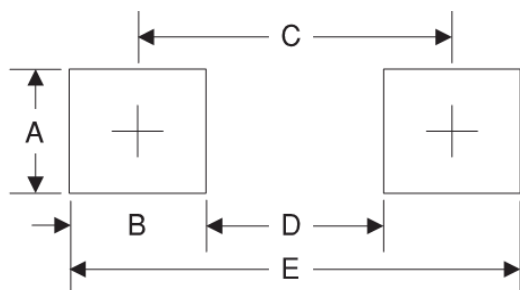

Symbol	Unit (mm)	Unit (inch)
A	1.68	0.066
B	1.52	0.060
C	3.93	0.155
D	2.41	0.095
E	5.45	0.215

MARKING DIAGRAM



- P/N = Specific Device Code
- G = Green Compound
- YW = Date Code
- F = Factory Code

Notice

Specifications of the products displayed herein are subject to change without notice. TSC or anyone on its behalf, assumes no responsibility or liability for any errors or inaccuracies.

Information contained herein is intended to provide a product description only. No license, express or implied, to any intellectual property rights is granted by this document. Except as provided in TSC's terms and conditions of sale for such products, TSC assumes no liability whatsoever, and disclaims any express or implied warranty, relating to sale and/or use of TSC products including liability or warranties relating to fitness for a particular purpose, merchantability, or infringement of any patent, copyright, or other intellectual property right.

The products shown herein are not designed for use in medical, life-saving, or life-sustaining applications. Customers using or selling these products for use in such applications do so at their own risk and agree to fully indemnify TSC for any damages resulting from such improper use or sale.

X-ON Electronics

Largest Supplier of Electrical and Electronic Components

Click to view similar products for [Rectifiers](#) category:

Click to view products by [Taiwan Semiconductor](#) manufacturer:

Other Similar products are found below :

[70HFR40](#) [FR105 R0](#) [RL252-TP](#) [1N5397](#) [1N4005-TR](#) [STTH1512P](#) [UFS120Je3/TR13](#) [JANS1N6640US](#) [20ETS12S](#) [RRE02VS6SGTR](#)
[MS306](#) [T110HF60](#) [80-5637](#) [A1N5404G-G](#) [CRF02\(T5L,TEMQ\)](#) [ACGRB207-HF](#) [CLH07\(TE16L,Q\)](#) [CLH03\(TE16L,Q\)](#) [1N5395-TP](#)
[UES1302](#) [ACGRC307-HF](#) [ACEFC304-HF](#) [DZ-1380](#) [85HFR60](#) [40HFR60](#) [70HF120](#) [85HFR80](#) [SCF7500](#) [SM100](#) [ACGRA4001-HF](#)
[SKN70/08](#) [SKR70/08](#) [NTE5819](#) [NTE5827](#) [NTE5828](#) [NTE5911](#) [NTE5915](#) [NTE6104](#) [NTE6163](#) [NTE6164](#) [NTE6165](#) [NTE6364](#) [TSD3G](#)
[SET130312](#) [NRVUS110VT3G](#) [UES1106](#) [UES1306](#) [NRVUS240VT3G](#) [D5FE60-5063](#) [R4000GPS-TP](#)