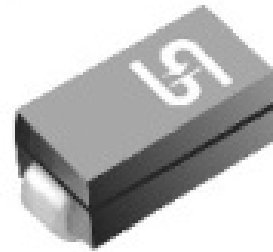

Surface Mount Ultra Fast Rectifiers

FEATURES

- Low power loss, high efficiency
- Ideal for automated placement
- Ultra fast recovery time for high efficiency
- High surge current capability
- Moisture sensitivity level : level 1, per J-STD-020
- Compliant to RoHS Directive 2011/65/EU and in accordance to WEEE 2002/96/EC
- Halogen-free according to IEC 61249-2-21 definition

DO-214AC(SMA)

MECHANICAL DATA

Case : DO-214AC(SMA)

Molding compound, UL flammability classification rating 94V-0
 Base P/N with suffix "G" on packing code - halogen-free, RoHS compliant

Terminal : Matte tin plated leads, solderable per JESD22-B102
 Meet JESD 201 class 1A whisker test

Polarity : Indicated by cathode band

Weight : 0.07 gram (approximately)

MAXIMUM RATINGS AND ELECTRICAL CHARACTERISTICS (T _A =25°C unless otherwise noted)					
PARAMETER	SYMBOL	ESH2BA	ESH2CA	ESH2DA	Unit
Maximum repetitive peak reverse voltage	V _{RRM}	100	150	200	V
Maximum RMS voltage	V _{RMS}	70	105	140	V
Maximum DC blocking voltage	V _{DC}	100	150	200	V
Maximum average forward rectified current	I _{F(AV)}	1			A
Peak forward surge current, 8.3 ms single half sine-wave superimposed on rated load	I _{FSM}	50			A
Maximum instantaneous forward voltage (Note 1) @ 1 A	V _F	0.90			V
Maximum reverse current @ rated VR	I _R	T _J =25 °C	1		μA
		T _J =100°C	10		
		T _J =125 °C	50		
Maximum reverse recovery time (Note 2)	T _{rr}	25			nS
Pulse energy in avalanche mode, non repetitive (inductive load switch off), L=120mH, T _J =25°C	E _{RSM}	20			mJ
Typical junction capacitance (Note 3)	C _j	25			pF
Typical thermal resistance	R _{θJL}	20			°C/W
	R _{θJA}	75			
Operating junction temperature range	T _J	- 55 to + 175			°C
Storage temperature range	T _{STG}	- 55 to + 175			°C

Note 1 : Pulse test with PW=300u sec, 1% duty cycle

Note 2: Reverse Recovery Test Conditions: I_F=0.5A, I_R=1.0A, I_{RR}=0.25A

Note 3: Measured at 1 MHz and Applied Reverse Voltage of 4.0V D.C.

ORDERING INFORMATION				
PART NO.	PACKING CODE	GREEN COMPOUND CODE	PACKAGE	PACKING
ESH2xA (Note 1)	R3	Suffix "G"	SMA	1800 / 7" Plastic reel
	R2		SMA	7500 / 13" Paper reel
	M2		SMA	7500 / 13" Plastic reel
	F3		Folded SMA	1800 / 7" Plastic reel
	F2		Folded SMA	7500 / 13" Paper reel
	F4		Folded SMA	7500 / 13" Plastic reel

Note 1: "xx" defines voltage from 100V (ESH2BA) to 200V (ESH2DA)

EXAMPLE				
PREFERRED P/N	PART NO.	PACKING CODE	GREEN COMPOUND CODE	DESCRIPTION
ESH2DA R3	ESH2DA	R3		
ESH2DA R3G	ESH2DA	R3	G	Green compound

RATINGS AND CHARACTERISTICS CURVES

(TA=25°C unless otherwise noted)

FIG.1 FORWARD CURRENT DERATING CURVE

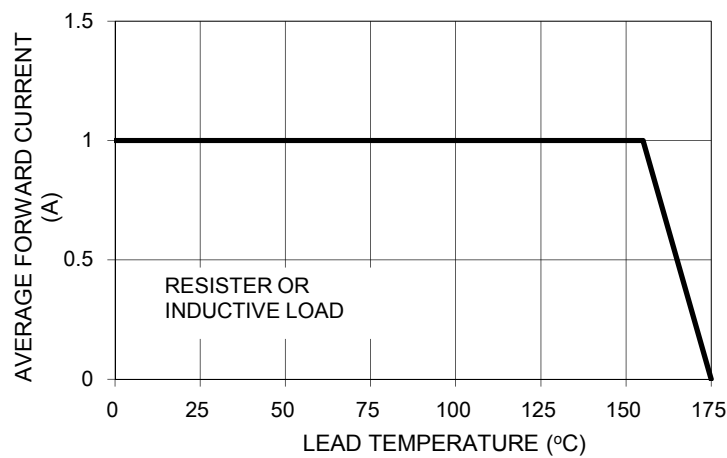

FIG. 2 TYPICAL REVERSE CHARACTERISTICS

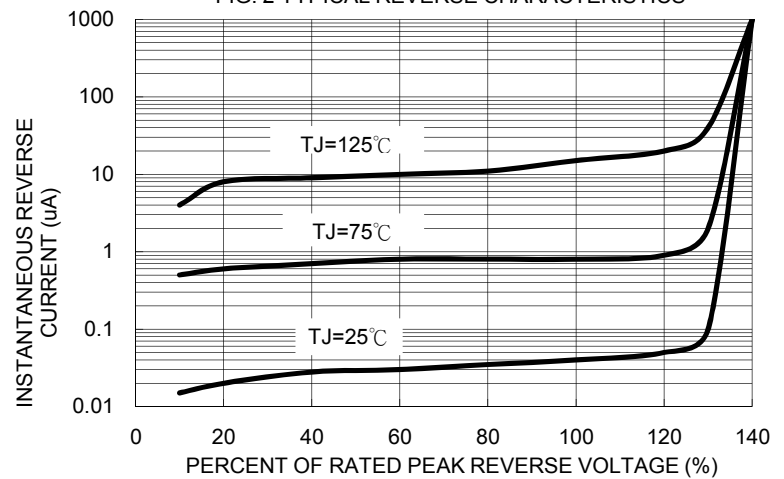

FIG. 3 MAXIMUM NON-REPETITIVE FORWARD SURGE CURRENT

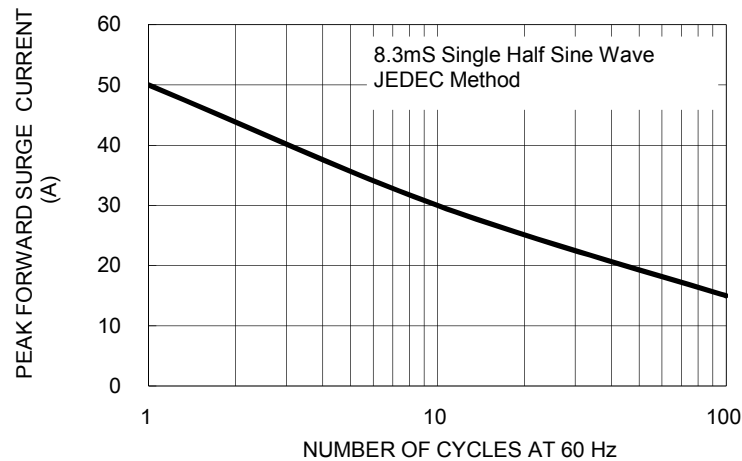

FIG. 4 TYPICAL FORWARD CHARACTERISTICS

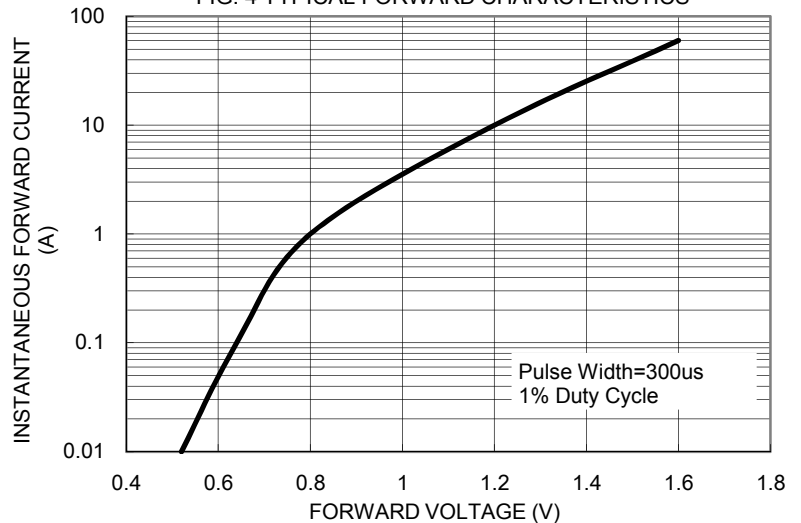

FIG. 5 TYPICAL JUNCTION CAPACITANCE

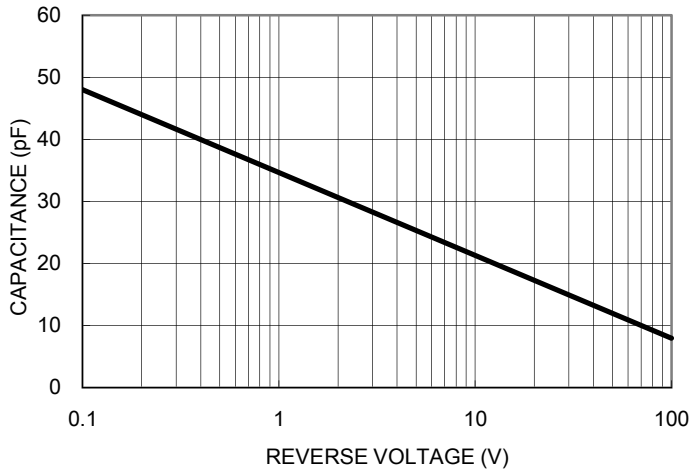
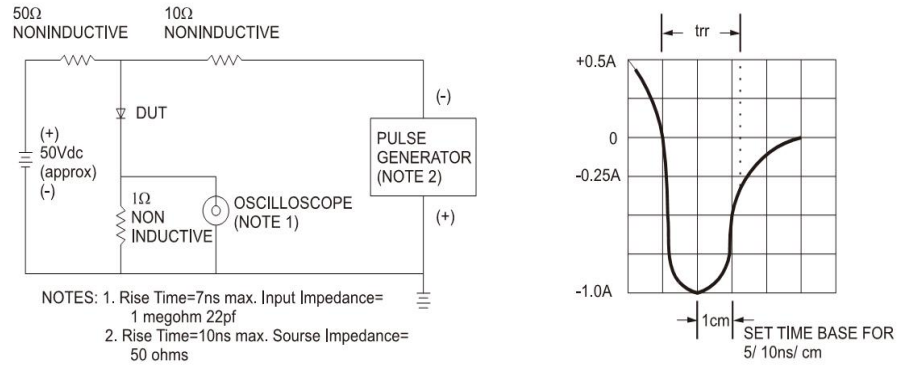
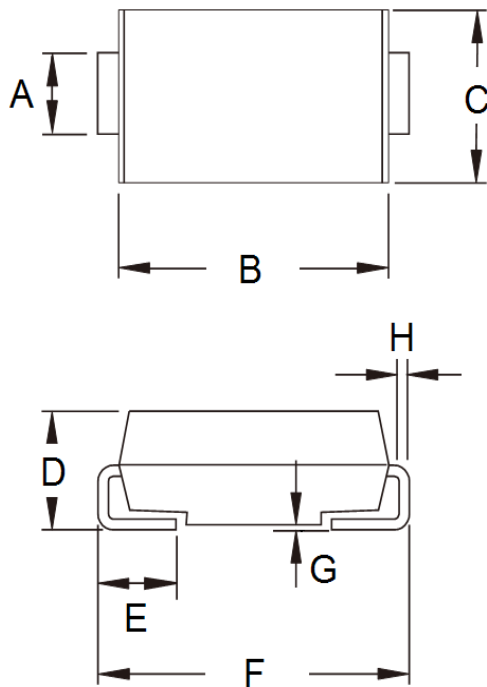

FIG.6- REVERSE RECOVERY TIME CHARACTERISTIC AND TEST CIRCUIT DIAGRAM



PACKAGE OUTLINE DIMENSIONS



DIM.	Unit(mm)		Unit(inch)	
	Min	Max	Min	Max
A	1.27	1.58	0.050	0.062
B	4.06	4.60	0.160	0.181
C	2.29	2.83	0.090	0.111
D	1.99	2.50	0.078	0.098
E	0.90	1.41	0.035	0.056
F	4.95	5.33	0.195	0.210
G	0.10	0.20	0.004	0.008
H	0.15	0.31	0.006	0.012

SUGGESTED PAD LAYOUT

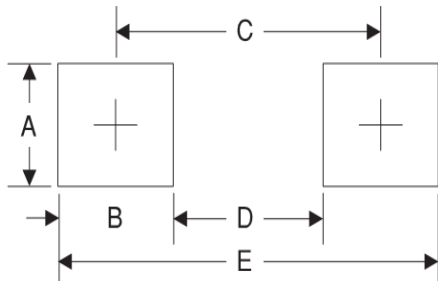

Symbol	Unit(mm)
A	1.68
B	1.52
C	3.93
D	2.41
E	5.45

MARKING DIAGRAM



- P/N = Specific Device Code
- G = Green Compound
- YW = Date Code
- F = Factory Code

X-ON Electronics

Largest Supplier of Electrical and Electronic Components

Click to view similar products for [Rectifiers](#) category:

Click to view products by [Taiwan Semiconductor](#) manufacturer:

Other Similar products are found below :

[70HFR40](#) [RL252-TP](#) [150KR30A](#) [1N5397](#) [NTE5841](#) [NTE6038](#) [SCF5000](#) [1N4002G](#) [1N4005-TR](#) [JANS1N6640US](#) [481235F](#)
[RRE02VS6SGTR](#) [067907F](#) [MS306](#) [70HF40](#) [T85HFL60S02](#) [US2JFL-TP](#) [A1N5404G-G](#) [CRS04\(T5L,TEMQ\)](#) [ACGRA4007-HF](#)
[ACGRB207-HF](#) [CLH03\(TE16L,Q\)](#) [ACGRC307-HF](#) [ACEFC304-HF](#) [NTE6356](#) [NTE6359](#) [NTE6002](#) [NTE6023](#) [NTE6039](#) [NTE6077](#)
[85HFR60](#) [40HFR60](#) [70HF120](#) [85HFR80](#) [D126A45C](#) [SCF7500](#) [D251N08B](#) [SCHJ22.5K](#) [SM100](#) [SCPA2](#) [SCH10000](#) [SDHD5K](#) [VS-](#)
[12FL100S10](#) [ACGRA4001-HF](#) [D1821SH45T PR](#) [D1251S45T](#) [NTE5990](#) [NTE6358](#) [NTE6162](#) [NTE5850](#)