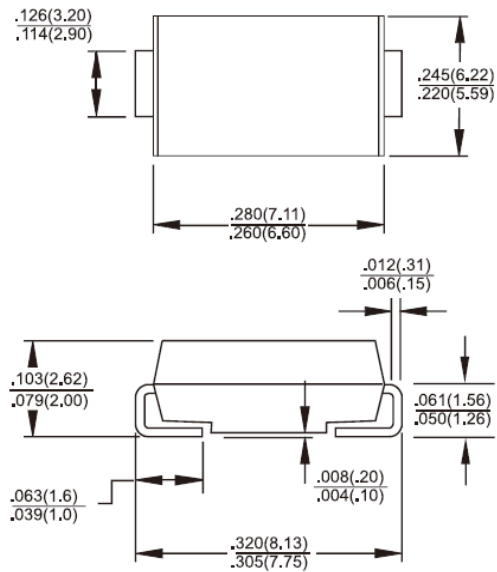

SMC/DO-214AB

Features

- ✧ For surface mounted application
- ✧ Glass passivated junction chip.
- ✧ Low forward voltage drop
- ✧ High current capability
- ✧ Easy pick and place
- ✧ High surge current capability
- ✧ Plastic material used carries Underwriters Laboratory Classification 94V-0
- ✧ High temperature soldering: 260°C/10 seconds at terminals
- ✧ Green compound with suffix "G" on packing code & prefix "G" on datecode.

Dimensions in inches and (millimeters)
Marking Diagram

- S4X = Specific Device Code
- G = Green Compound
- Y = Year
- M = Work Month

Mechanical Data

- ✧ Case: Molded plastic
- ✧ Terminals: Pure tin plated, lead free.
- ✧ Polarity: Indicated by cathode band
- ✧ Packaging: 16mm tape per EIA STD RS-481
- ✧ Weight: 0.21 grams

Maximum Ratings and Electrical Characteristics

Rating at 25 °C ambient temperature unless otherwise specified.

Single phase, half wave, 60 Hz, resistive or inductive load.

For capacitive load, derate current by 20%

Type Number	Symbol	S4A	S4B	S4D	S4G	S4J	S4K	S4M	Units
Maximum Recurrent Peak Reverse Voltage	V_{RRM}	50	100	200	400	600	800	1000	V
Maximum RMS Voltage	V_{RMS}	35	70	140	280	420	560	700	V
Maximum DC Blocking Voltage	V_{DC}	50	100	200	400	600	800	1000	V
Maximum Average Forward Rectified Current @ $T_L=75^\circ\text{C}$	$I_{F(AV)}$	4							A
Peak Forward Surge Current, 8.3 ms Single Half Sine-wave Superimposed on Rated Load (JEDEC method)	I_{FSM}	100							A
Maximum Instantaneous Forward Voltage (Note 1) @ 4 A	V_F	1.15							V
Maximum DC Reverse Current @ $T_A=25^\circ\text{C}$ at Rated DC Blocking Voltage @ $T_A=125^\circ\text{C}$	I_R	10 250							uA uA
Typical Reverse Recovery Time (Note 2)	T_{rr}	1.5							uS
Typical Junction Capacitance (Note 3)	C_j	60							pF
Typical Thermal Resistance	$R_{\theta JL}$ $R_{\theta JA}$	13 47							$^\circ\text{C/W}$
Operating Temperature Range	T_J	- 55 to + 150							$^\circ\text{C}$
Storage Temperature Range	T_{STG}	- 55 to + 150							$^\circ\text{C}$

Notes: 1. Pulse Test with PW=300 usec, 1% Duty Cycle

 2. Reverse Recovery Test Conditions: $I_F=0.5\text{A}$, $I_R=1.0\text{A}$, $I_{RR}=0.25\text{A}$

 3. Measured at 1 MHz and Applied $V_R=4.0$ Volts

RATINGS AND CHARACTERISTIC CURVES (S4A THRU S4M)

FIG.1- MAXIMUM FORWARD CURRENT DERATING CURVE

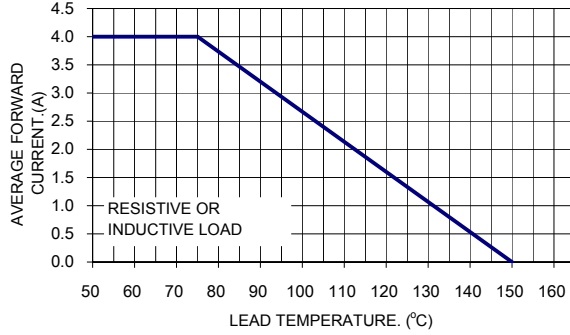

FIG.2- TYPICAL REVERSE CHARACTERISTICS

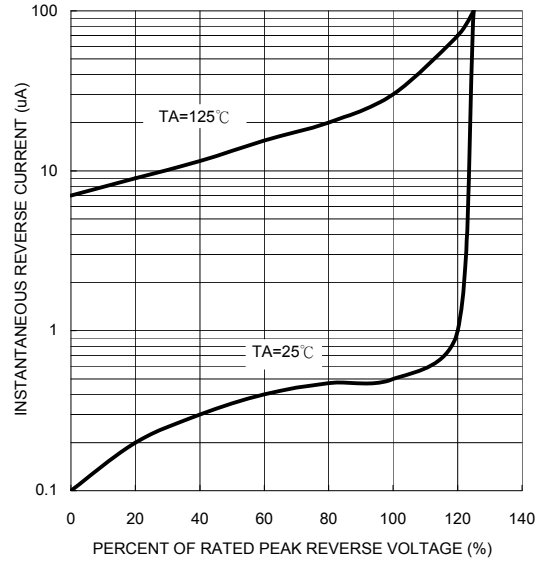

FIG.3- MAXIMUM NON-REPETITIVE FORWARD SURGE CURRENT

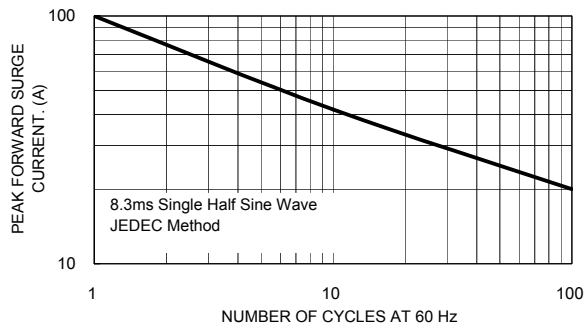

FIG.5- TYPICAL FORWARD CHARACTERISTICS

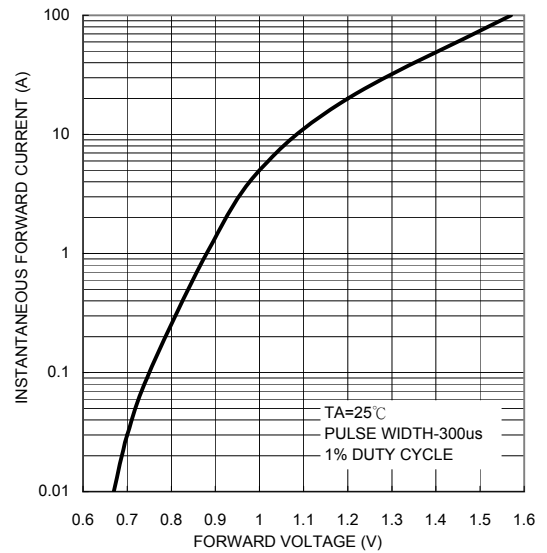

FIG.4- TYPICAL JUNCTION CAPACITANCE

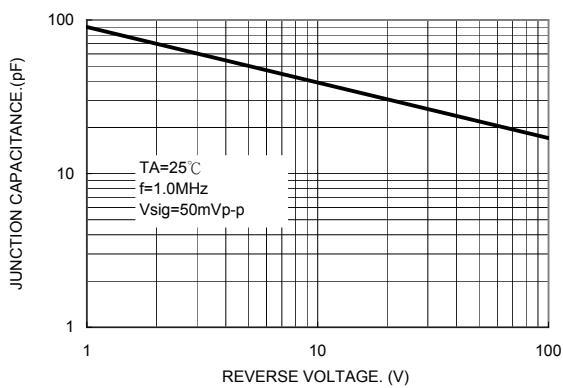
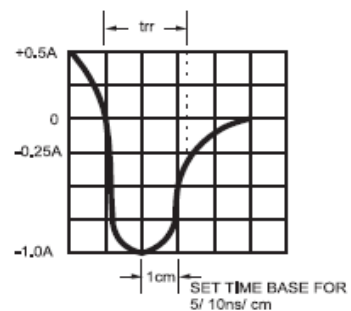
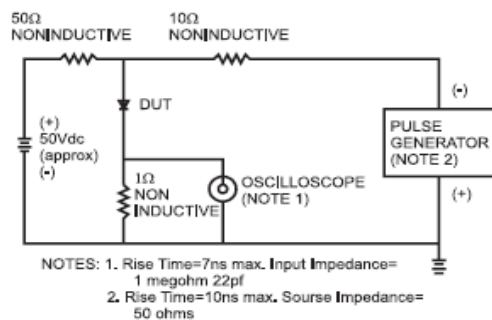

FIG.6- REVERSE RECOVERY TIME CHARACTERISTIC AND TEST CIRCUIT DIAGRAM



X-ON Electronics

Largest Supplier of Electrical and Electronic Components

Click to view similar products for [Rectifiers](#) category:

Click to view products by [Taiwan Semiconductor](#) manufacturer:

Other Similar products are found below :

[70HFR40](#) [RL252-TP](#) [150KR30A](#) [1N5397](#) [NTE5841](#) [NTE6038](#) [SCF5000](#) [1N4002G](#) [1N4005-TR](#) [JANS1N6640US](#) [481235F](#)
[RRE02VS6SGTR](#) [067907F](#) [MS306](#) [70HF40](#) [T85HFL60S02](#) [US2JFL-TP](#) [A1N5404G-G](#) [CRS04\(T5L,TEMQ\)](#) [ACGRA4007-HF](#)
[ACGRB207-HF](#) [CLH03\(TE16L,Q\)](#) [ACGRC307-HF](#) [ACEFC304-HF](#) [NTE6356](#) [NTE6359](#) [NTE6002](#) [NTE6023](#) [NTE6039](#) [NTE6077](#)
[85HFR60](#) [40HFR60](#) [70HF120](#) [85HFR80](#) [D126A45C](#) [SCF7500](#) [D251N08B](#) [SCHJ22.5K](#) [SM100](#) [SCPA2](#) [SCH10000](#) [SDHD5K](#) [VS-](#)
[12FL100S10](#) [ACGRA4001-HF](#) [D1821SH45T PR](#) [D1251S45T](#) [NTE5990](#) [NTE6358](#) [NTE6162](#) [NTE5850](#)