

## Dual Common Cathode Schottky Rectifier

### FEATURES

- Low power loss, high efficiency
- Guardring for overvoltage protection
- High surge current capability
- UL Recognized File # E-326243
- Compliant to RoHS Directive 2011/65/EU and in accordance to WEEE 2002/96/EC
- Halogen-free according to IEC 61249-2-21 definition

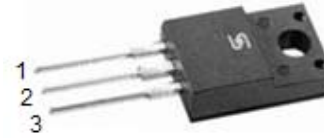

**ITO-220AB**

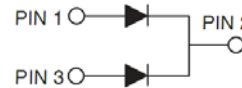

### MECHANICAL DATA

**Case:** ITO-220AB

Molding compound, UL flammability classification rating 94V-0

Base P/N with suffix "G" on packing code - halogen-free

Base P/N with prefix "H" on packing code - AEC-Q101 qualified

**Terminal:** Matte tin plated leads, solderable per JESD22-B102

Meet JESD 201 class 1A whisker test

with prefix "H" on packing code meet JESD 201 class 2 whisker test

**Polarity:** As marked

**Mounting torque:** 5 in-lbs maximum

**Weight:** 1.7 g (approximately)

MAXIMUM RATINGS AND ELECTRICAL CHARACTERISTICS (T <sub>A</sub> =25°C unless otherwise noted)											
PARAMETER	SYMBOL	SRF 2020	SRF 2030	SRF 2040	SRF 2050	SRF 2060	SRF 2090	SRF 20100	SRF 20150	UNIT	
Maximum repetitive peak reverse voltage	V <sub>RRM</sub>	20	30	40	50	60	90	100	150	V	
Maximum RMS voltage	V <sub>RMS</sub>	14	21	28	35	42	63	70	105	V	
Maximum DC blocking voltage	V <sub>DC</sub>	20	30	40	50	60	90	100	150	V	
Maximum average forward rectified current	I <sub>F(AV)</sub>	20								A	
Peak forward surge current, 8.3 ms single half sine-wave superimposed on rated load	I <sub>FSM</sub>	200								A	
Maximum Instantaneous Forward Voltage (Note 1) I <sub>F</sub> = 10 A	V <sub>F</sub>	0.55			0.70		0.92		1.02	V	
Maximum reverse current @ Rated VR T <sub>J</sub> =25 °C T <sub>J</sub> =100 °C T <sub>J</sub> =125 °C	I <sub>R</sub>	0.5					0.1				mA
		15			10		-				
		-					5				
Typical thermal resistance	R <sub>θJC</sub>	1.5								°C/W	
Operating junction temperature range	T <sub>J</sub>	- 55 to +125				- 55 to +150					°C
Storage temperature range	T <sub>STG</sub>	- 55 to +150									°C

Note 1: Pulse test with PW=300µs, 1% duty cycle

ORDERING INFORMATION					
PART NO.	AEC-Q101 QUALIFIED	PACKING CODE	GREEN COMPOUND CODE	PACKAGE	PACKING
SRF20xx (Note 1)	Prefix "H"	C0	Suffix "G"	ITO-220AB	50 / Tube

Note 1: "xx" defines voltage from 20V (SRF2020) to 150V (SRF20150)

EXAMPLE					
PREFERRED P/N	PART NO.	AEC-Q101 QUALIFIED	PACKING CODE	GREEN COMPOUND CODE	DESCRIPTION
SRF2060 C0	SRF2060		C0		
SRF2060 C0G	SRF2060		C0	G	Green compound
SRF2060HC0	SRF2060	H	C0		AEC-Q101 qualified

**RATINGS AND CHARACTERISTICS CURVES**

(TA=25°C unless otherwise noted)

FIG.1 FORWARD CURRENT DERATING CURVE

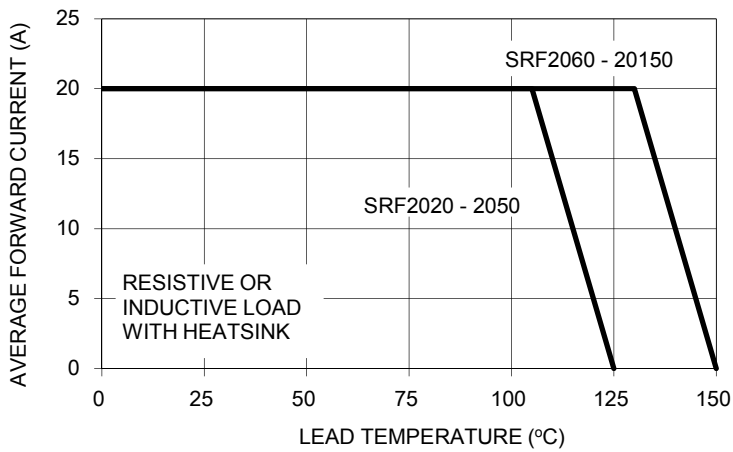

FIG. 2 MAXIMUM NON-REPETITIVE FORWARD SURGE CURRENT

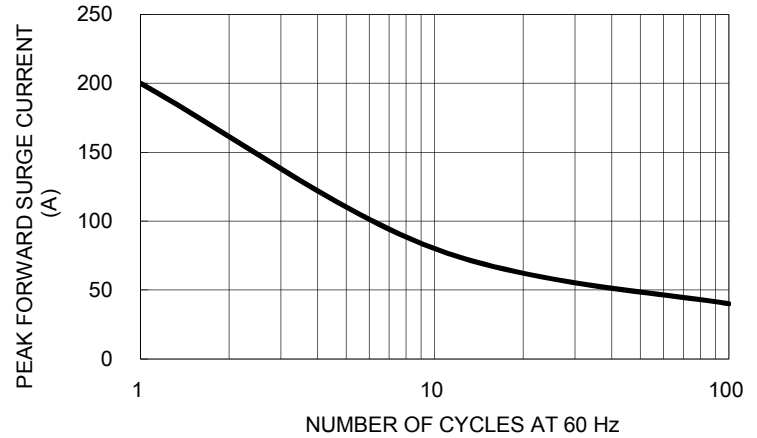

FIG. 3 TYPICAL FORWARD CHARACTERISTICS

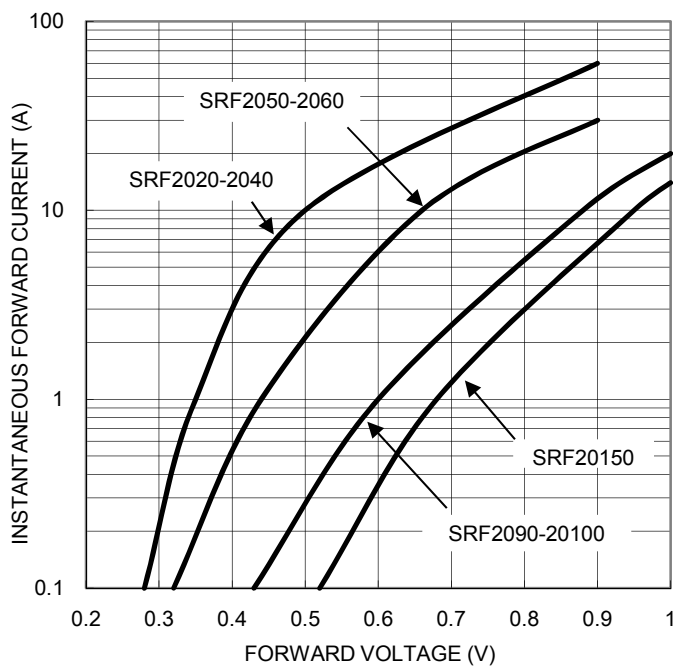

FIG. 4 TYPICAL REVERSE CHARACTERISTICS

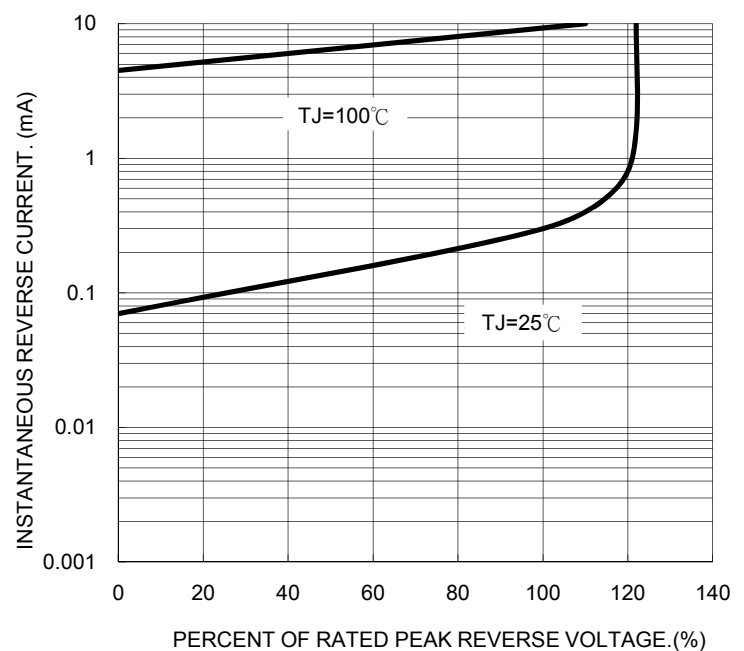

FIG. 5 TYPICAL JUNCTION CAPACITANCE

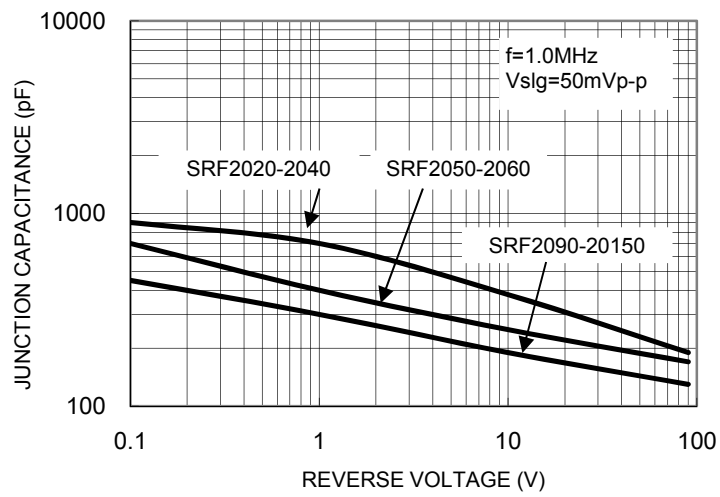
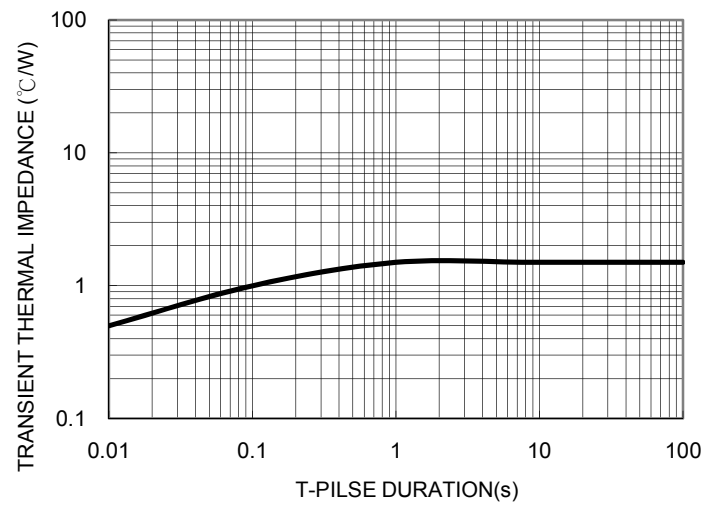
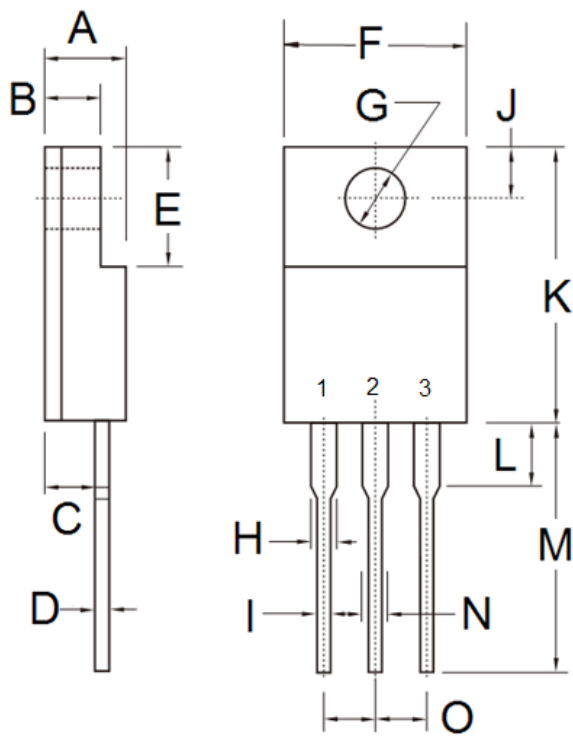

FIG. 6 TYPICAL TRANSIENT THERMAL IMPEDANCE



PACKAGE OUTLINE DIMENSIONS



DIM.	Unit (mm)		Unit (inch)	
	Min	Max	Min	Max
A	4.30	4.70	0.169	0.185
B	2.50	3.16	0.098	0.124
C	2.30	2.96	0.091	0.117
D	0.46	0.76	0.018	0.030
E	6.30	6.90	0.248	0.272
F	9.60	10.30	0.378	0.406
G	3.00	3.40	0.118	0.134
H	0.95	1.45	0.037	0.057
I	0.50	0.90	0.020	0.035
J	2.40	3.20	0.094	0.126
K	14.80	15.50	0.583	0.610
L	-	4.10	-	0.161
M	12.60	13.80	0.496	0.543
N	-	1.80	-	0.071
O	2.41	2.67	0.095	0.105

MARKING DIAGRAM



- P/N = Specific Device Code
- G = Green Compound
- YWW = Date Code
- F = Factory Code

## Notice

Specifications of the products displayed herein are subject to change without notice. TSC or anyone on its behalf, assumes no responsibility or liability for any errors inaccuracies.

Information contained herein is intended to provide a product description only. No license, express or implied, to any intellectual property rights is granted by this document. Except as provided in TSC's terms and conditions of sale for such products, TSC assumes no liability whatsoever, and disclaims any express or implied warranty, relating to sale and/or use of TSC products including liability or warranties relating to fitness for a particular purpose, merchantability, or infringement of any patent, copyright, or other intellectual property right.

The products shown herein are not designed for use in medical, life-saving, or life-sustaining applications. Customers using or selling these products for use in such applications do so at their own risk and agree to fully indemnify TSC for any damages resulting from such improper use or sale.

## X-ON Electronics

Largest Supplier of Electrical and Electronic Components

*Click to view similar products for [Schottky Diodes & Rectifiers](#) category:*

*Click to view products by [Taiwan Semiconductor](#) manufacturer:*

Other Similar products are found below :

[MA4E2039](#) [D1FH3-5063](#) [MBR10100CT-BP](#) [MBR1545CT](#) [MMBD301M3T5G](#) [RB160M-50TR](#) [RB551V-30](#) [BAS16E6433HTMA1](#) [BAT](#)  
[54-02LRH E6327](#) [NSR05F40QNXT5G](#) [NTE555](#) [JANS1N6640](#) [SB07-03C-TB-H](#) [SB1003M3-TL-W](#) [SK310-T](#) [SK32A-LTP](#) [SK33A-TP](#)  
[SK34B-TP](#) [SS3003CH-TL-E](#) [GA01SHT18](#) [CRS10I30A\(TE85L,QM](#) [MA4E2501L-1290](#) [MBRB30H30CT-1G](#) [SB007-03C-TB-E](#) [SK32A-TP](#)  
[SK33B-TP](#) [SK35A-TP](#) [SK38B-TP](#) [NRVBM120LT1G](#) [NTE505](#) [NTSB30U100CT-1G](#) [SS15E-TP](#) [VS-6CWQ10FNHM3](#) [ACDBA1100LR-HF](#)  
[ACDBA1200-HF](#) [ACDBA140-HF](#) [ACDBA2100-HF](#) [ACDBA3100-HF](#) [CDBQC0530L-HF](#) [CDBQC0240LR-HF](#) [ACDBA340-HF](#)  
[ACDBA260LR-HF](#) [ACDBA1100-HF](#) [SK310B-TP](#) [MA4E2502L-1246](#) [MA4E2502H-1246](#) [NRVBM120ET1G](#) [NSR01L30MXT5G](#) [NTE573](#)  
[NTE6081](#)