

Small Signal Product

Low Capacitance ESD Protection Array

FEATURES

- Meet IEC61000-4-2 (ESD) $\pm 15\text{kV}$ (air), $\pm 8\text{kV}$ (contact)
- Meet IEC61000-4-4 (EFT) rating. 40A (5/50ns)
- Meet IEC61000-4-5 (Lightning) rating. 12A (8/20 μs)
- Protects two directional I/O lines
- Working voltage: 5V
- Low leakage current
- Pb free version and RoHS compliant
- Packing code with suffix "G" means green compound (halogen-free)



SOT-23

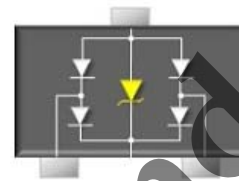

MECHANICAL DATA

- Case: SOT-23 small outline plastic package
- Terminal: Matte tin plated, lead free., solderable per MIL-STD-202, Method 208 guaranteed
- High temperature soldering guaranteed : 260°C/10s
- Weight: 8 \pm 0.5 mg
- Marking code : Y D05

APPLICATIONS

- USB Power & Data Line Protection
- Ethernet 10BaseT
- T1/E1 Secondary IC Side Protection
- ISDN S/T Interface
- WAN/LAN Equipment

MAXIMUM RATINGS AND ELECTRICAL CHARACTERISTICS (T _A =25°C unless otherwise noted)			
PARAMETER	SYMBOL	VALUE	UNIT
Peak Pulse Power (tp=8/20 μs waveform)	P _{PP}	350	W
ESD per IEC 61000-4-2 (Air)	V _{ESD}	± 15	KV
ESD per IEC 61000-4-2 (Contact)		± 8	
Junction and Storage Temperature Range	T _J , T _{STG}	-55 to +150	°C

PARAMETER	SYMBOL	MIN	MAX	UNIT
Reverse Stand-Off Voltage	V _{RWM}	-	5	V
Reverse Breakdown Voltage	V _(BR)	6	-	V
Reverse Leakage Current				
Clamping Voltage	V _C	-	9.8	V
			12	
Junction Capacitance	C _J	1		pF

Small Signal Product

RATINGS AND CHARACTERISTICS CURVES

($T_A=25^\circ\text{C}$ unless otherwise noted)

Fig. 1 Admissible Power Dissipation Curve

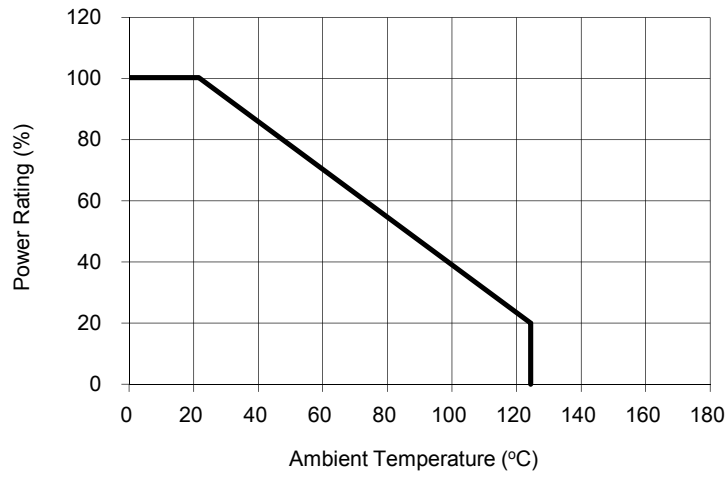

Fig. 2 Pulse Waveform

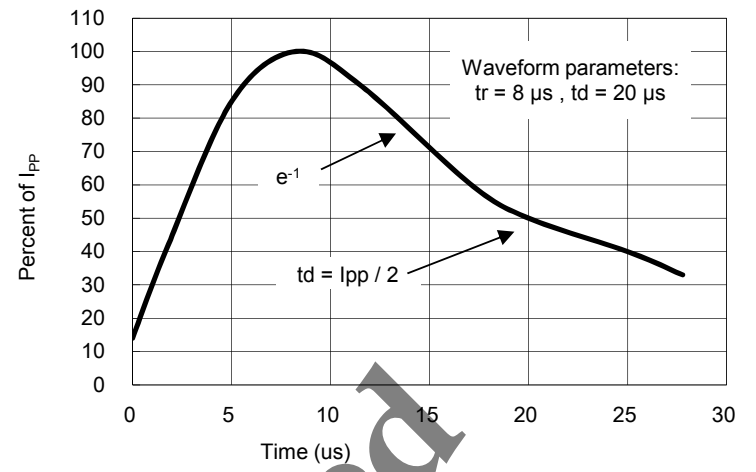

Fig. 3 Clamping Voltage VS. Peak Pulse Current

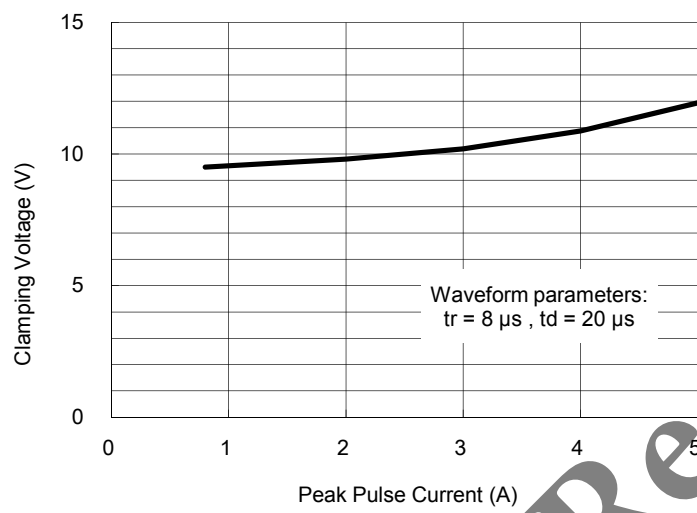
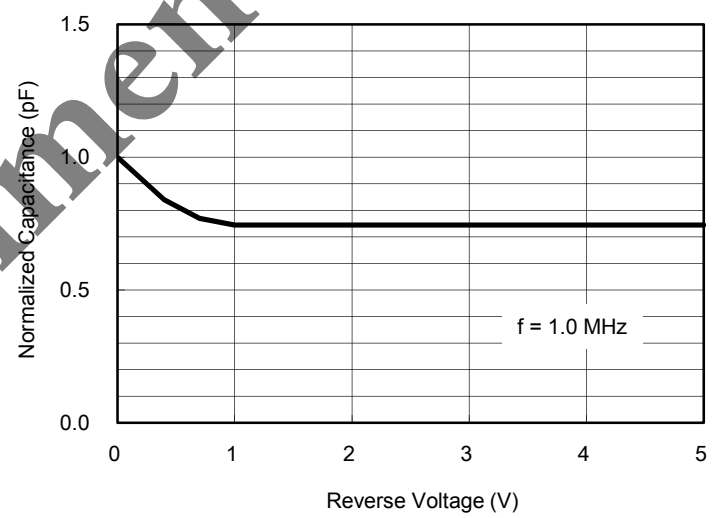

Fig. 4 Typical Junction Capacitance



Not Recommended

Small Signal Product

ORDER INFORMATION (EXAMPLE)

TESDA5V0A RFG

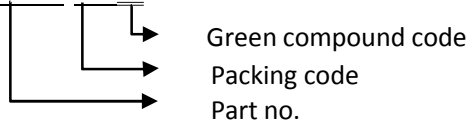

PACKAGE OUTLINE DIMENSIONS

SOT-23

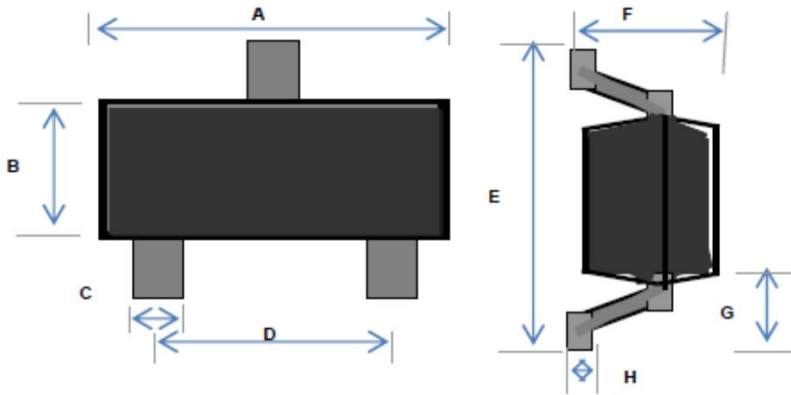

DIM.	Unit (mm)		Unit (inch)	
	Min	Max	Min	Max
A	2.70	3.10	0.106	0.122
B	1.10	1.50	0.043	0.059
C	0.30	0.51	0.012	0.020
D	1.78	2.04	0.070	0.080
E	2.10	2.64	0.083	0.104
F	0.89	1.30	0.035	0.051
G	0.55 REF		0.022 REF	
H	0.10 REF		0.004 REF	

SUGGEST PAD LAYOUT

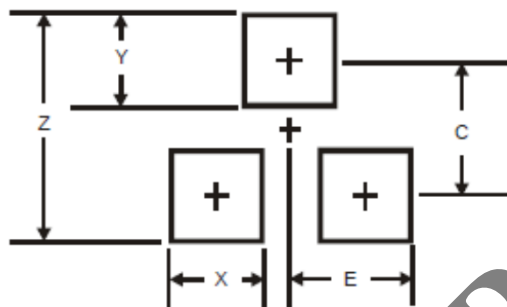

DIM.	Unit (mm)		Unit (inch)	
	Typ.		Typ.	
Z	2.8		0.110	
X	0.7		0.028	
Y	0.9		0.035	
C	1.9		0.075	
E	1.0		0.039	

Note: 1. The suggested land pattern dimensions have been provided for reference only, as actual pad layouts may vary depending on application.

Small Signal Product

APPLICATIONS INFORMATION

- ◇ Designed for the bi-directional protection of 2 lines from the damage caused by Electro Static Discharge (ESD) and surge pulses
- ◇ Be used on lines where the signal polarities are above and below ground
- ◇ Provides a surge capability of 350 Watts peak Ppp per line for an 8/20 ms waveform

CIRCUIT BOARD LAYOUT RECOMMENDATIONS

- ◇ Place the ESD Protection array as close to the input terminal or connector as possible
- ◇ Keep parallel signal paths to a minimum
- ◇ Minimize all printed-circuit board conductive loops including power and group loops
- ◇ Avoid using shared transient return paths to a common ground point
- ◇ Ground planes should be used. For multilayer printed-circuit boards, use ground vias
- ◇ Below picture is the typical application for bi-directional protection of two lines

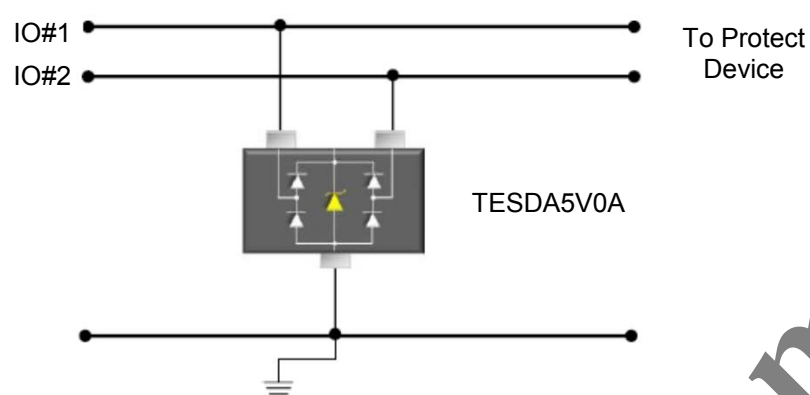

Not Recommended

Not Recommended

Notice

Specifications of the products displayed herein are subject to change without notice. TSC or anyone on its behalf, assumes no responsibility or liability for any errors or inaccuracies.

Information contained herein is intended to provide a product description only. No license, express or implied, to any intellectual property rights is granted by this document. Except as provided in TSC's terms and conditions of sale for such products, TSC assumes no liability whatsoever, and disclaims any express or implied warranty, relating to sale and/or use of TSC products including liability or warranties relating to fitness for a particular purpose, merchantability, or infringement of any patent, copyright, or other intellectual property right.

The products shown herein are not designed for use in medical, life-saving, or life-sustaining applications. Customers using or selling these products for use in such applications do so at their own risk and agree to fully indemnify TSC for any damages resulting from such improper use or sale.

X-ON Electronics

Largest Supplier of Electrical and Electronic Components

Click to view similar products for [ESD Suppressors / TVS Diodes](#) category:

Click to view products by [Taiwan Semiconductor](#) manufacturer:

Other Similar products are found below :

[60KS200C](#) [D12V0H1U2WS-7](#) [D18V0L1B2LP-7B](#) [82356050220](#) [D5V0M5U6V-7](#) [NTE4902](#) [P4KE27CA](#) [P6KE11CA](#) [P6KE39CA-TP](#)
[P6KE8.2A](#) [SA110CA](#) [SA60CA](#) [SA64CA](#) [SMBJ12CATR](#) [SMBJ8.0A](#) [SMLJ30CA-TP](#) [ESD101-B1-02ELS E6327](#) [ESD112-B1-02EL E6327](#)
[ESD119B1W01005E6327XTSA1](#) [ESD5V0L1B02VH6327XTSA1](#) [ESD7451N2T5G](#) [19180-510](#) [CPDT-5V0USP-HF](#) [3.0SMCJ33CA-F](#)
[3.0SMCJ36A-F](#) [HSPC16701B02TP](#) [D3V3Q1B2DLP3-7](#) [D55V0M1B2WS-7](#) [DESD5V0U1BL-7B](#) [DRTR5V0U4SL-7](#) [SCM1293A-04SO](#)
[ESD200-B1-CSP0201 E6327](#) [ESD203-B1-02EL E6327](#) [SM12-7](#) [SMF8.0A-TP](#) [SMLJ45CA-TP](#) [CEN955 W/DATA](#) [82350120560](#)
[82356240030](#) [VESD12A1A-HD1-GS08](#) [CPDUR5V0R-HF](#) [CPDUR24V-HF](#) [CPDQC5V0U-HF](#) [CPDQC5V0USP-HF](#) [CPDQC5V0-HF](#)
[D1213A-01LP4-7B](#) [D1213A-02WL-7](#) [ESDLIN1524BJ-HQ](#) [5KP100A](#) [5KP15A](#)