

AUTOMOTIVE N-Channel 60V 175°C MOSFET

FEATURES

- AEC-Q101 Qualified
- 100% UIS and R_g Tested
- 175°C Operating Junction Temperature
- Wettable Flank Package
- RoHS Compliant
- Halogen-free according to IEC 61249-2-21

APPLICATIONS

- 12V Automotive Systems
- Solenoid and Motor Control
- Automotive Transmission Control
- DC-DC Converters

PRODUCT SUMMARY		
PARAMETER	VALUE	UNIT
V _{DS}	60	V
R _{DS(on)} (max)	V _{GS} = 10V	13
	V _{GS} = 7V	18.5
Q _g	40	nC



PDFN56U

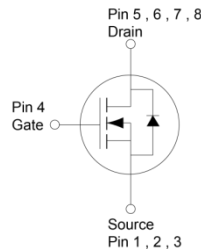
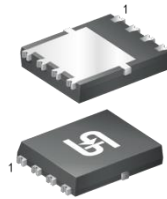

Note: MSL 1 (Moisture Sensitivity Level) per J-STD-020

ABSOLUTE MAXIMUM RATINGS (T _A = 25°C unless otherwise noted)			
PARAMETER	SYMBOL	LIMIT	UNIT
Drain-Source Voltage	V _{DS}	60	V
Gate-Source Voltage	V _{GS}	±20	V
Continuous Drain Current (Note 1)	I _D	T _C = 25°C	50
		T _A = 25°C	10
Pulsed Drain Current	I _{DM}	200	A
Single Pulse Avalanche Current (Note 2)	I _{AS}	21	A
Single Pulse Avalanche Energy (Note 2)	E _{AS}	66	mJ
Total Power Dissipation	P _D	T _C = 25°C	83
		T _C = 125°C	28
Total Power Dissipation	P _D	T _A = 25°C	3.1
		T _A = 125°C	1
Operating Junction and Storage Temperature Range	T _J , T _{STG}	- 55 to +175	°C

THERMAL RESISTANCE			
PARAMETER	SYMBOL	MAXIMUM	UNIT
Thermal Resistance – Junction to Case	R _{θJC}	1.8	°C/W
Thermal Resistance – Junction to Ambient	R _{θJA}	48	°C/W

Thermal Performance Note: R_{θJA} is the sum of the junction-to-case and case-to-ambient thermal resistances. The case-thermal reference is defined at the solder mounting surface of the drain pins. R_{θJC} is guaranteed by design while R_{θCA} is determined by the user's board design. The R_{θJA} limit presented here is based on mounting on a 1 in² pad of 2 oz copper.

ELECTRICAL CHARACTERISTICS ($T_A = 25^\circ\text{C}$ unless otherwise noted)						
PARAMETER	CONDITIONS	SYMBOL	MIN	TYP	MAX	UNIT
Static						
Drain-Source Breakdown Voltage	$V_{GS} = 0\text{V}, I_D = 250\mu\text{A}$	BV_{DSS}	60	--	--	V
Gate Threshold Voltage	$V_{GS} = V_{DS}, I_D = 250\mu\text{A}$	$V_{GS(TH)}$	1.8	2.6	3.8	V
Gate-Source Leakage Current	$V_{GS} = \pm 20\text{V}, V_{DS} = 0\text{V}$	I_{GSS}	--	--	± 100	nA
Drain-Source Leakage Current	$V_{GS} = 0\text{V}, V_{DS} = 60\text{V}$	I_{DSS}	--	--	1	μA
	$V_{GS} = 0\text{V}, V_{DS} = 60\text{V}$ $T_J = 125^\circ\text{C}$		--	--	100	
	$V_{GS} = 0\text{V}, V_{DS} = 60\text{V}$ $T_J = 175^\circ\text{C}$		--	--	500	
Drain-Source On-State Resistance (Note 3)	$V_{GS} = 10\text{V}, I_D = 10\text{A}$	$R_{DS(on)}$	--	11.7	13	m Ω
	$V_{GS} = 10\text{V}, I_D = 10\text{A},$ $T_J = 125^\circ\text{C}$		--	23.4	26	
	$V_{GS} = 10\text{V}, I_D = 10\text{A},$ $T_J = 175^\circ\text{C}$		--	30.4	33.8	
	$V_{GS} = 7\text{V}, I_D = 8\text{A}$		--	12.4	18.5	
Forward Transconductance (Note 3)	$V_{DS} = 10\text{V}, I_D = 10\text{A}$	g_{fs}	--	44	--	S
Dynamic (Note 4)						
Total Gate Charge	$V_{GS} = 10\text{V}, V_{DS} = 30\text{V},$ $I_D = 10\text{A}$	Q_g	--	40	--	nC
Total Gate Charge	$V_{GS} = 7\text{V}, V_{DS} = 30\text{V},$ $I_D = 8\text{A}$	Q_g	--	29	--	
Gate-Source Charge		Q_{gs}	--	10	--	
Gate-Drain Charge		Q_{gd}	--	10	--	
Input Capacitance	$V_{GS} = 0\text{V}, V_{DS} = 30\text{V},$ $f = 1.0\text{MHz}$	C_{iss}	--	2234	--	pF
Output Capacitance		C_{oss}	--	147	--	
Reverse Transfer Capacitance		C_{rss}	--	65	--	
Gate Resistance	$f = 1.0\text{MHz}$	R_g	0.5	1.8	3.6	Ω
Switching (Note 4)						
Turn-On Delay Time	$V_{GS} = 10\text{V}, V_{DS} = 30\text{V},$ $I_D = 10\text{A}, R_G = 2\Omega$	$t_{d(on)}$	--	5	--	ns
Rise Time		t_r	--	21	--	
Turn-Off Delay Time		$t_{d(off)}$	--	24	--	
Fall Time		t_f	--	18	--	
Source-Drain Diode						
Diode Forward Voltage (Note 3)	$V_{GS} = 0\text{V}, I_S = 10\text{A}$	V_{SD}	--	--	1	V
Reverse Recovery Time	$I_S = 10\text{A},$ $di/dt = 100\text{A}/\mu\text{s}$	t_{rr}	--	22	--	ns
Reverse Recovery Charge		Q_{rr}	--	19	--	nC

Notes:

1. Silicon limited current only.
2. $L = 0.3\text{mH}, V_{GS} = 10\text{V}, V_{DD} = 30\text{V}, R_G = 50\Omega, I_{AS} = 21\text{A},$ Starting $T_J = 25^\circ\text{C}$
3. Pulse test: Pulse Width $\leq 300\mu\text{s}$, duty cycle $\leq 2\%$.
4. Switching time is essentially independent of operating temperature.

ORDERING INFORMATION

ORDERING CODE	PACKAGE	PACKING
TQM130NB06CR RLG	PDFN56U	2,500pcs / 13" Reel

CHARACTERISTICS CURVES

($T_A = 25^\circ\text{C}$ unless otherwise noted)

Output Characteristics

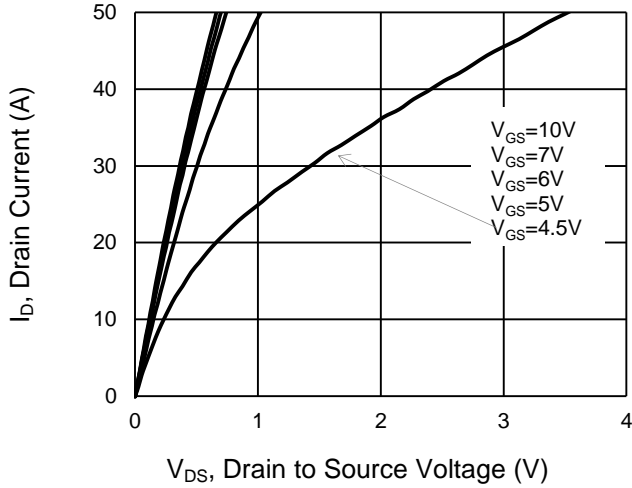

Transfer Characteristics

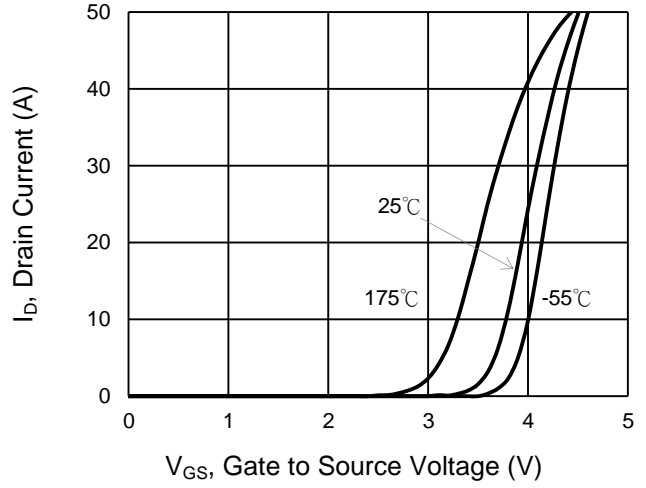

On-Resistance vs. Drain Current

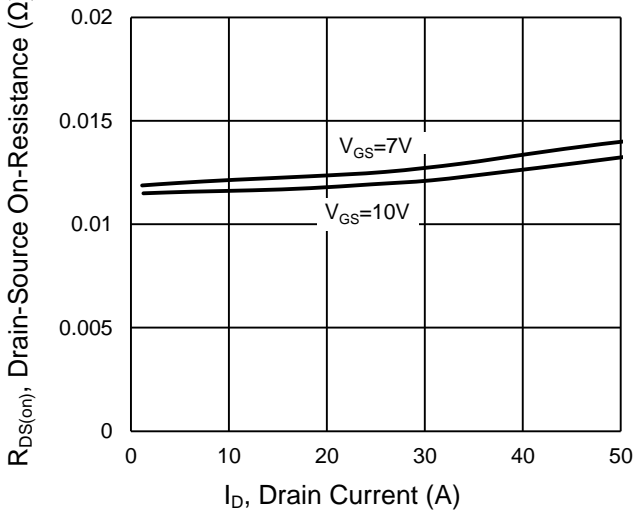

Gate-Source Voltage vs. Gate Charge

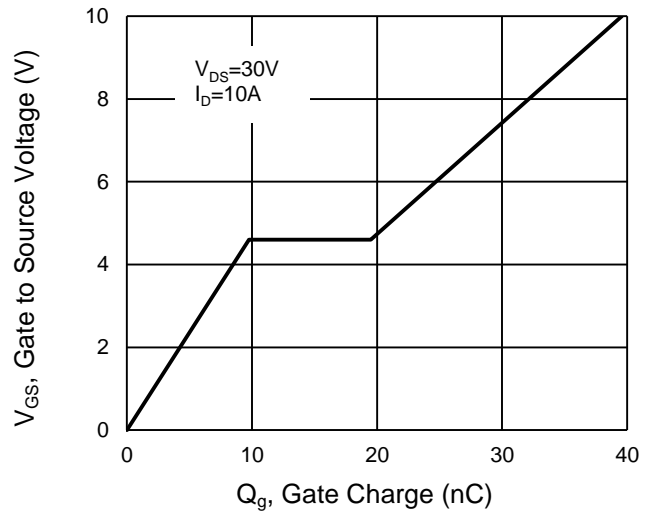

On-Resistance vs. Junction Temperature

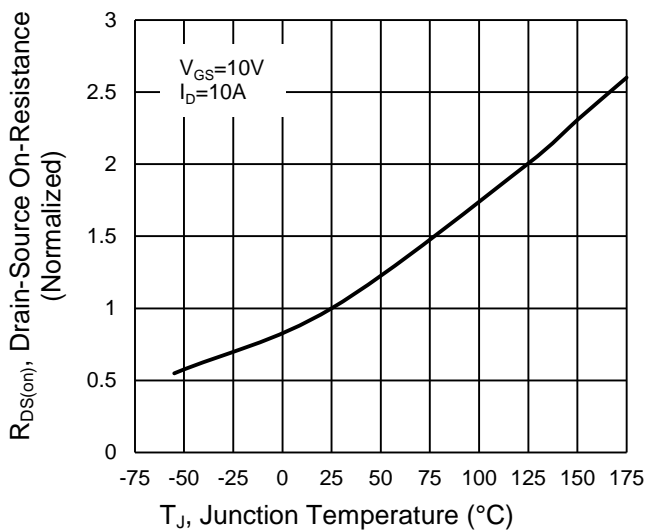

On-Resistance vs. Gate-Source Voltage

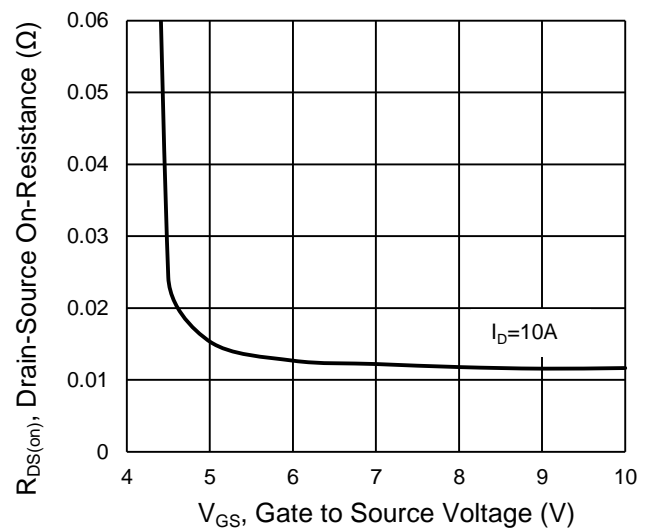

CHARACTERISTICS CURVES

($T_A = 25^\circ\text{C}$ unless otherwise noted)

Capacitance vs. Drain-Source Voltage

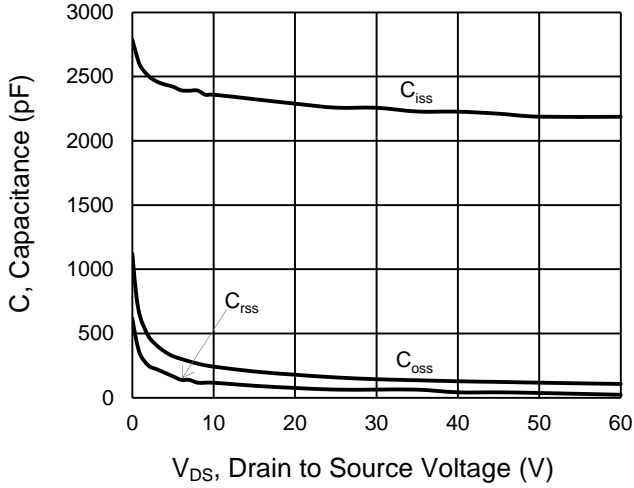

BV_{DSS} vs. Junction Temperature

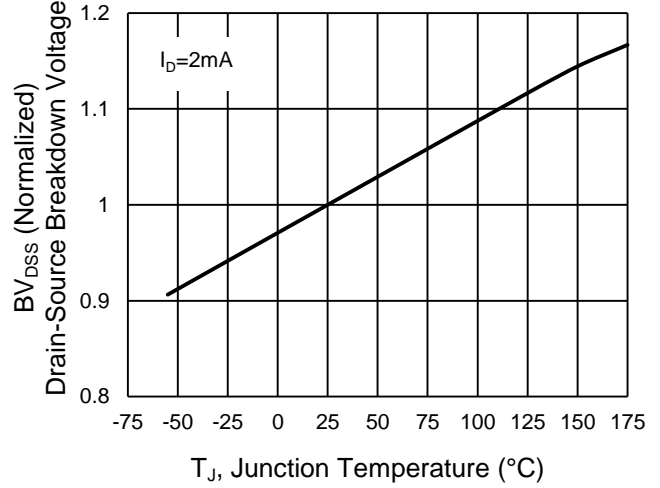

Maximum Safe Operating Area, Junction-to-Case

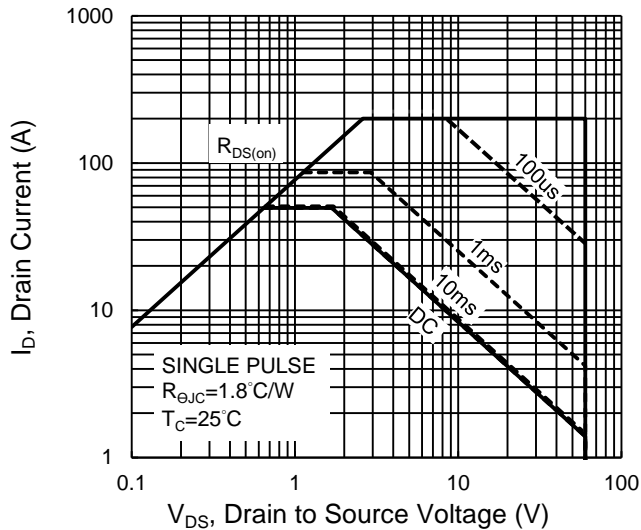

Source-Drain Diode Forward Current vs. Voltage

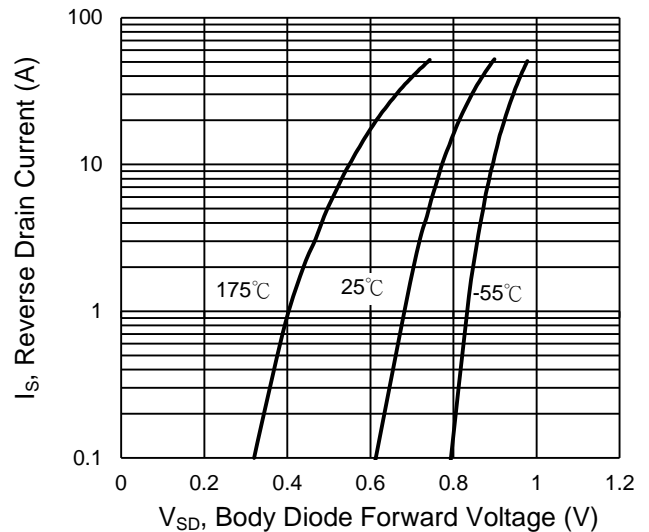

Normalized Thermal Transient Impedance, Junction-to-Case

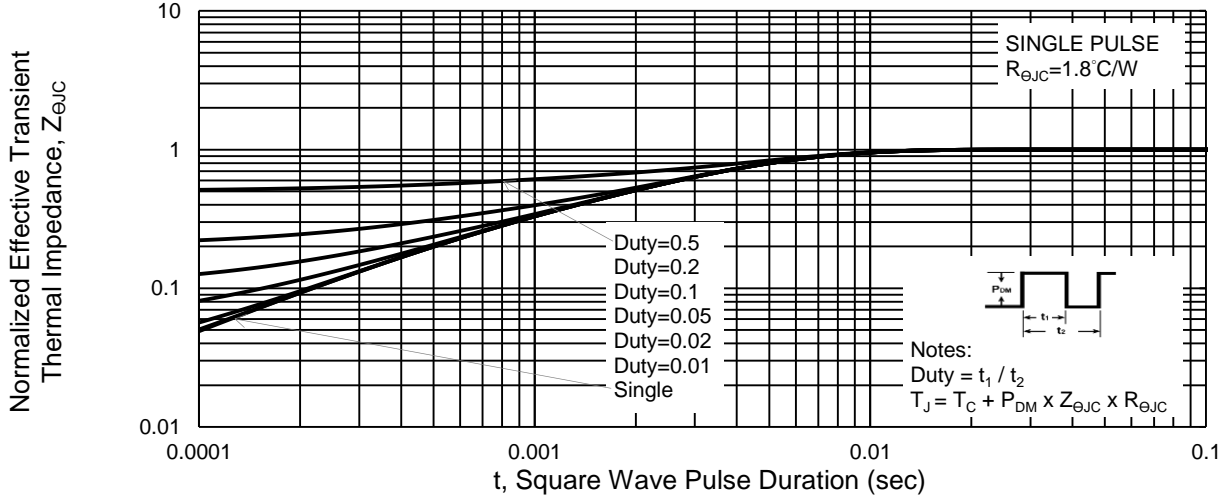

PACKAGE OUTLINE DIMENSIONS (Unit: Millimeters)

PDFN56U

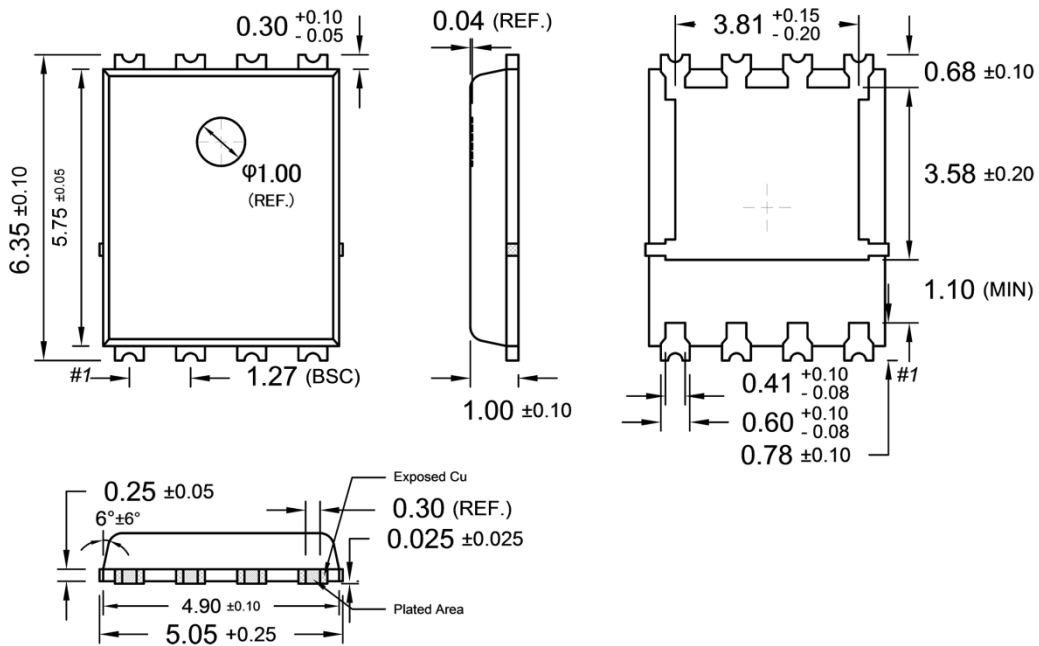

SUGGESTED PAD LAYOUT (Unit: Millimeters)

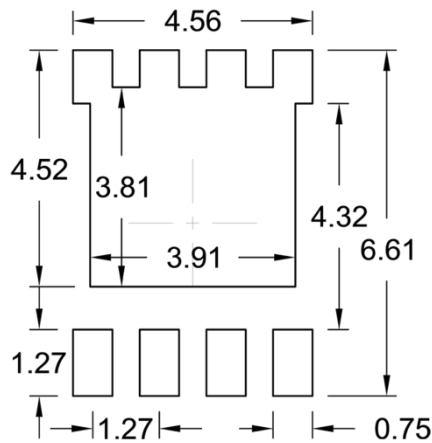

MARKING DIAGRAM

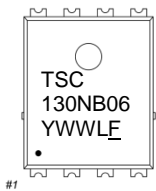

- Y** = Year Code
- WW** = Week Code (01~52)
- L** = Lot Code (1~9, A~Z)
- F** = Factory Code
- = AEC-Q101 Qualified

Notice

Specifications of the products displayed herein are subject to change without notice. TSC or anyone on its behalf, assumes no responsibility or liability for any errors or inaccuracies.

Purchasers are solely responsible for the choice, selection, and use of TSC products and TSC assumes no liability for application assistance or the design of Purchasers' products.

Information contained herein is intended to provide a product description only. No license, express or implied, to any intellectual property rights is granted by this document. Except as provided in TSC's terms and conditions of sale for such products, TSC assumes no liability whatsoever, and disclaims any express or implied warranty, relating to sale and/or use of TSC products including liability or warranties relating to fitness for a particular purpose, merchantability, or infringement of any patent, copyright, or other intellectual property right.

The products shown herein are not designed for use in medical, life-saving, or life-sustaining applications. Customers using or selling these products for use in such applications do so at their own risk and agree to fully indemnify TSC for any damages resulting from such improper use or sale.

X-ON Electronics

Largest Supplier of Electrical and Electronic Components

Click to view similar products for [MOSFET](#) category:

Click to view products by [Taiwan Semiconductor](#) manufacturer:

Other Similar products are found below :

[614233C](#) [648584F](#) [IRFD120](#) [JANTX2N5237](#) [FCA20N60_F109](#) [FDZ595PZ](#) [2SK2545\(Q,T\)](#) [405094E](#) [423220D](#) [TPCC8103,L1Q\(CM](#)
[MIC4420CM-TR](#) [VN1206L](#) [SBVS138LT1G](#) [614234A](#) [715780A](#) [NTNS3166NZT5G](#) [SSM6J414TU,LF\(T](#) [751625C](#) [BUK954R8-60E](#)
[DMN3404LQ-7](#) [NTE6400](#) [SQJ402EP-T1-GE3](#) [2SK2614\(TE16L1,Q\)](#) [2N7002KW-FAI](#) [DMN1017UCP3-7](#) [EFC2J004NUZTDG](#) [ECH8691-](#)
[TL-W](#) [FCAB21350L1](#) [P85W28HP2F-7071](#) [DMN1053UCP4-7](#) [NTE221](#) [NTE2384](#) [NTE2903](#) [NTE2941](#) [NTE2945](#) [NTE2946](#) [NTE2960](#)
[NTE2967](#) [NTE2969](#) [NTE2976](#) [NTE455](#) [NTE6400A](#) [NTE2910](#) [NTE2916](#) [NTE2956](#) [NTE2911](#) [DMN2080UCB4-7](#) [TK10A80W,S4X\(S](#)
[SSM6P69NU,LF](#) [DMP22D4UFO-7B](#)