

## 3-Terminal Fixed Positive Voltage Regulator

### DESCRIPTION

The TS7800 series voltage regulators are monolithic integrated circuits designed as fixed-voltage regulators for a wide variety of applications including local, on-card regulation. These regulators employ internal current limiting, thermal shutdown, and safe-area compensation. With adequate heatsink they can deliver output currents up to 1 ampere. Although designed primarily as a fixed voltage regulator, these devices can be used with external components to obtain adjustable voltages and currents.

### FEATURES

- Output Voltage Range 5V, 8V, 9V, 12V, 24V
- Output current up to 1A
- No external components required
- Internal thermal overload protection
- Internal short-circuit current limiting
- Output transistor safe-area compensation
- Output voltage offered in 4% tolerance
- Compliant to RoHS Directive 2011/65/EU and in accordance to WEEE 2002/96/EC.
- Halogen-free according to IEC 61249-2-21

### APPLICATION

- Power supply
- Home appliance



TO-220

Pin Definition:

1. Input
2. Ground (tab)
3. Output

### TYPICAL APPLICATION CIRCUIT

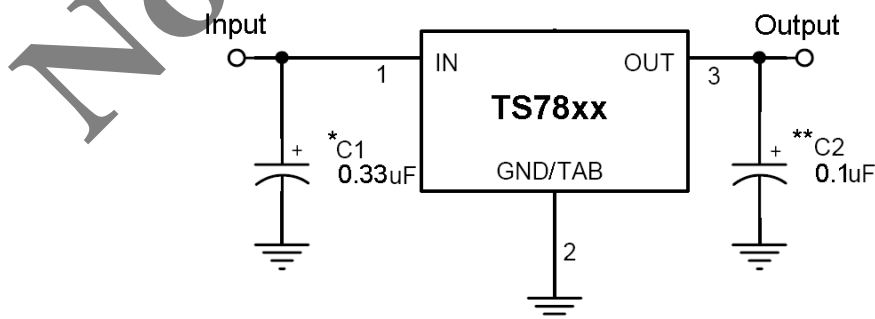

A common ground is required between the input and the output voltages. The input voltage must remain typically 2.0V above the output voltage even during the low point on the Input ripple voltage.

XX = these two digits of the type number indicate voltage.

\* =  $C_{IN}$  is required if regulator is located an appreciable distance from power supply filter.

\*\* =  $C_{OUT}$  is not needed for stability; however, it does improve transient response.

<b>ABSOLUTE MAXIMUM RATINGS</b> ( $T_A = 25^\circ\text{C}$ unless otherwise noted) <sup>(Note 1)</sup>				
<b>PARAMETER</b>		<b>SYMBOL</b>	<b>LIMIT</b>	<b>UNIT</b>
Input Voltage	$V_{\text{OUT}}=5\text{V}, 8\text{V}, 9\text{V}, 12\text{V}$	$V_{\text{IN}}$	35	V
	$V_{\text{OUT}}=24\text{V}$		40	
Output Current		$I_{\text{OUT}}$	Internal Limited	
Power Dissipation		$P_D$	Internal Limited	
Operating Junction Temperature		$T_J$	0~+125	$^\circ\text{C}$
Storage Temperature Range		$T_{\text{STG}}$	-65~+150	$^\circ\text{C}$
Thermal Resistance - Junction to Case		$R_{\theta\text{JC}}$	5	$^\circ\text{C/W}$
Thermal Resistance - Junction to Ambient		$R_{\theta\text{JA}}$	50	$^\circ\text{C/W}$

**Note:**

Absolute maximum ratings are those values beyond which damage to the device may occur. Functional operation under these conditions is not implied.

<b>TS7805 ELECTRICAL SPECIFICATIONS</b>							
(V <sub>IN</sub> =10V, I <sub>OUT</sub> =500mA, 0 $^\circ\text{C}$ ≤T <sub>J</sub> ≤125 $^\circ\text{C}$ , C <sub>IN</sub> =0.33μF, C <sub>OUT</sub> =0.1μF; unless otherwise specified.)							
<b>PARAMETER</b>	<b>SYMBOL</b>	<b>CONDITIONS</b>	<b>MIN</b>	<b>TYP</b>	<b>MAX</b>	<b>UNIT</b>	
Output voltage	$V_{\text{OUT}}$	$T_J=25^\circ\text{C}$	4.80	5	5.20	V	
		$7.5\text{V} \leq V_{\text{IN}} \leq 20\text{V}$ , $10\text{mA} \leq I_{\text{OUT}} \leq 1\text{A}$ , $P_D \leq 15\text{W}$	4.75	5	5.25		
Line Regulation	REG <sub>LINE</sub>	$T_J=25^\circ\text{C}$	$7.5\text{V} \leq V_{\text{IN}} \leq 25\text{V}$	--	3	100	mV
			$8\text{V} \leq V_{\text{IN}} \leq 12\text{V}$	--	1	50	
Load Regulation	REG <sub>LOAD</sub>	$T_J=25^\circ\text{C}$	$10\text{mA} \leq I_{\text{OUT}} \leq 1\text{A}$	--	15	100	mV
			$250\text{mA} \leq I_{\text{OUT}} \leq 750\text{mA}$	--	5	50	
Quiescent Current	$I_Q$	$I_{\text{OUT}}=0$ , $T_J=25^\circ\text{C}$	--	4.2	8	mA	
Quiescent Current Change	$\Delta I_Q$	$7.5\text{V} \leq V_{\text{IN}} \leq 25\text{V}$ $10\text{mA} \leq I_{\text{OUT}} \leq 1\text{A}$	--	--	1.3		
			--	--	0.5		
Output Noise Voltage	$V_N$	$10\text{Hz} \leq f \leq 100\text{KHz}$ , $T_J=25^\circ\text{C}$	--	40	--	μV	
Ripple Rejection Ratio	RR	$f=120\text{Hz}$ , $8\text{V} \leq V_{\text{IN}} \leq 18\text{V}$	62	78	--	dB	
Voltage Drop	$V_{\text{DROP}}$	$I_{\text{OUT}}=1.0\text{A}$ , $T_J=25^\circ\text{C}$	--	2	--	V	
Output Resistance	$R_{\text{OUT}}$	$f=1\text{KHz}$	--	17	--	mΩ	
Output Short Circuit Current	$I_{\text{OS}}$	$T_J=25^\circ\text{C}$	--	750	--	mA	
Peak Output Current	$I_{\text{O peak}}$	$T_J=25^\circ\text{C}$	--	2.2	--	A	
Temperature Coefficient of Output Voltage	$\Delta V_{\text{OUT}} / \Delta T_J$	$I_{\text{OUT}}=10\text{mA}$ , $0^\circ\text{C} \leq T_J \leq 125^\circ\text{C}$	--	-0.6	--	mV/ $^\circ\text{C}$	

**Note:**

- Pulse testing techniques are used to maintain the junction temperature as close to the ambient temperature as possible and thermal effects must be taken into account separately.
- This specification applies only for DC power dissipation permitted by absolute maximum ratings.

**TS7808 ELECTRICAL SPECIFICATIONS**

 ( $V_{IN}=14V$ ,  $I_{OUT}=500mA$ ,  $0^{\circ}C \leq T_J \leq 125^{\circ}C$ ,  $C_{IN}=0.33\mu F$ ,  $C_{OUT}=0.1\mu F$ ; unless otherwise specified.)

PARAMETER	SYMBOL	CONDITIONS	MIN	TYP	MAX	UNIT	
Output voltage	$V_{OUT}$	$T_J=25^{\circ}C$	7.69	8	8.32	V	
		$10.5V \leq V_{IN} \leq 23V$ , $10mA \leq I_{OUT} \leq 1A$ , $P_D \leq 15W$	7.61	8	8.40		
Line Regulation	$REG_{LINE}$	$T_J=25^{\circ}C$	$10.5V \leq V_{IN} \leq 25V$	6	100	160	mV
			$11V \leq V_{IN} \leq 17V$	2	50	80	
Load Regulation	$REG_{LOAD}$	$T_J=25^{\circ}C$	$10mA \leq I_{OUT} \leq 1A$	12	100	160	mV
			$250mA \leq I_{OUT} \leq 750mA$	4	50	80	
Quiescent Current	$I_Q$	$I_{OUT}=0$ , $T_J=25^{\circ}C$	--	4.3	8	mA	
Quiescent Current Change	$\Delta I_Q$	$10.5V \leq V_{IN} \leq 25V$	--	--	1		
		$10mA \leq I_{OUT} \leq 1A$	--	--	0.5		
Output Noise Voltage	$V_N$	$10Hz \leq f \leq 100KHz$ , $T_J=25^{\circ}C$	--	52	--	$\mu V$	
Ripple Rejection Ratio	RR	$f=120Hz$ , $11V \leq V_{IN} \leq 21V$	56	72	--	dB	
Voltage Drop	$V_{DROP}$	$I_{OUT}=1.0A$ , $T_J=25^{\circ}C$	--	2	--	V	
Output Resistance	$R_{OUT}$	$f=1KHz$	--	16	--	$m\Omega$	
Output Short Circuit Current	$I_{OS}$	$T_J=25^{\circ}C$	--	450	--	mA	
Peak Output Current	$I_{O\ peak}$	$T_J=25^{\circ}C$	--	2.2	--	A	
Temperature Coefficient of Output Voltage	$\Delta V_{OUT} / \Delta T_J$	$I_{OUT}=10mA$ , $0^{\circ}C \leq T_J \leq 125^{\circ}C$	--	-0.8	--	mV/ $^{\circ}C$	

**TS7809 ELECTRICAL SPECIFICATIONS**

 ( $V_{IN}=15V$ ,  $I_{OUT}=500mA$ ,  $0^{\circ}C \leq T_J \leq 125^{\circ}C$ ,  $C_{IN}=0.33\mu F$ ,  $C_{OUT}=0.1\mu F$ ; unless otherwise specified.)

PARAMETER	SYMBOL	CONDITIONS	MIN	TYP	MAX	UNIT	
Output voltage	$V_{OUT}$	$T_J=25^{\circ}C$	8.65	9	9.36	V	
		$11.5V \leq V_{IN} \leq 23V$ , $10mA \leq I_{OUT} \leq 1A$ , $P_D \leq 15W$	8.57	9	9.45		
Line Regulation	$REG_{LINE}$	$T_J=25^{\circ}C$	$11.5V \leq V_{IN} \leq 26V$	6	100	180	mV
			$12V \leq V_{IN} \leq 17V$	2	50	90	
Load Regulation	$REG_{LOAD}$	$T_J=25^{\circ}C$	$10mA \leq I_{OUT} \leq 1A$	12	100	180	mV
			$250mA \leq I_{OUT} \leq 750mA$	4	50	90	
Quiescent Current	$I_Q$	$I_{OUT}=0$ , $T_J=25^{\circ}C$	--	4.3	8	mA	
Quiescent Current Change	$\Delta I_Q$	$11.5V \leq V_{IN} \leq 26V$	--	--	1		
		$10mA \leq I_{OUT} \leq 1A$	--	--	0.5		
Output Noise Voltage	$V_N$	$10Hz \leq f \leq 100KHz$ , $T_J=25^{\circ}C$	--	52	--	$\mu V$	
Ripple Rejection Ratio	RR	$f=120Hz$ , $12V \leq V_{IN} \leq 22V$	55	72	--	dB	
Voltage Drop	$V_{DROP}$	$I_{OUT}=1.0A$ , $T_J=25^{\circ}C$	--	2	--	V	
Output Resistance	$R_{OUT}$	$f=1KHz$	--	16	--	$m\Omega$	
Output Short Circuit Current	$I_{OS}$	$T_J=25^{\circ}C$	--	450	--	mA	
Peak Output Current	$I_{O\ peak}$	$T_J=25^{\circ}C$	--	2.2	--	A	
Temperature Coefficient of Output Voltage	$\Delta V_{OUT} / \Delta T_J$	$I_{OUT}=10mA$ , $0^{\circ}C \leq T_J \leq 125^{\circ}C$	--	-1	--	mV/ $^{\circ}C$	

**Note:**

1. Pulse testing techniques are used to maintain the junction temperature as close to the ambient temperature as possible and thermal effects must be taken into account separately.
2. This specification applies only for DC power dissipation permitted by absolute maximum ratings.

**TS7812 ELECTRICAL SPECIFICATIONS**

 ( $V_{IN}=19V$ ,  $I_{OUT}=500mA$ ,  $0^{\circ}C \leq T_J \leq 125^{\circ}C$ ,  $C_{IN}=0.33\mu F$ ,  $C_{OUT}=0.1\mu F$ ; unless otherwise specified.)

PARAMETER	SYMBOL	CONDITIONS	MIN	TYP	MAX	UNIT	
Output voltage	$V_{OUT}$	$T_J=25^{\circ}C$	11.53	12	12.48	V	
		$14.5V \leq V_{IN} \leq 27V$ , $10mA \leq I_{OUT} \leq 1A$ , $P_D \leq 15W$	11.42	12	12.60		
Line Regulation	$REG_{LINE}$	$T_J=25^{\circ}C$	$14.5V \leq V_{IN} \leq 30V$	10	100	240	mV
			$15V \leq V_{IN} \leq 19V$	3	50	120	
Load Regulation	$REG_{LOAD}$	$T_J=25^{\circ}C$	$10mA \leq I_{OUT} \leq 1A$	12	100	240	mV
			$250mA \leq I_{OUT} \leq 750mA$	4	50	120	
Quiescent Current	$I_Q$	$I_{OUT}=0$ , $T_J=25^{\circ}C$	--	4.3	8	mA	
Quiescent Current Change	$\Delta I_Q$	$14.5V \leq V_{IN} \leq 30V$	--	--	1		
		$10mA \leq I_{OUT} \leq 1A$	--	--	0.5		
Output Noise Voltage	$V_N$	$10Hz \leq f \leq 100KHz$ , $T_J=25^{\circ}C$	--	75	--	$\mu V$	
Ripple Rejection Ratio	RR	$f=120Hz$ , $15V \leq V_{IN} \leq 25V$	55	71	--	dB	
Voltage Drop	$V_{DROP}$	$I_{OUT}=1.0A$ , $T_J=25^{\circ}C$	--	2	--	V	
Output Resistance	$R_{OUT}$	$f=1KHz$	--	18	--	$m\Omega$	
Output Short Circuit Current	$I_{OS}$	$T_J=25^{\circ}C$	--	350	--	mA	
Peak Output Current	$I_{O\ peak}$	$T_J=25^{\circ}C$	--	2.2	--	A	
Temperature Coefficient of Output Voltage	$\Delta V_{OUT} / \Delta T_J$	$I_{OUT}=10mA$ , $0^{\circ}C \leq T_J \leq 125^{\circ}C$	--	-1	--	mV/ $^{\circ}C$	

**TS7824 ELECTRICAL SPECIFICATIONS**

 ( $V_{IN}=33V$ ,  $I_{OUT}=500mA$ ,  $0^{\circ}C \leq T_J \leq 125^{\circ}C$ ,  $C_{IN}=0.33\mu F$ ,  $C_{OUT}=0.1\mu F$ ; unless otherwise specified.)

PARAMETER	SYMBOL	CONDITIONS	MIN	TYP	MAX	UNIT	
Output voltage	$V_{OUT}$	$T_J=25^{\circ}C$	23.07	24	24.96	V	
		$27V \leq V_{IN} \leq 38V$ , $10mA \leq I_{OUT} \leq 1A$ , $P_D \leq 15W$	22.85	24	25.20		
Line Regulation	$REG_{LINE}$	$T_J=25^{\circ}C$	$27V \leq V_{IN} \leq 38V$	18	100	480	mV
			$28V \leq V_{IN} \leq 32V$	6	50	240	
Load Regulation	$REG_{LOAD}$	$T_J=25^{\circ}C$	$10mA \leq I_{OUT} \leq 1A$	12	100	480	mV
			$250mA \leq I_{OUT} \leq 750mA$	4	50	240	
Quiescent Current	$I_Q$	$I_{OUT}=0$ , $T_J=25^{\circ}C$	--	4.6	8	mA	
Quiescent Current Change	$\Delta I_Q$	$27V \leq V_{IN} \leq 38V$	--	--	1		
		$10mA \leq I_{OUT} \leq 1A$	--	--	0.5		
Output Noise Voltage	$V_N$	$10Hz \leq f \leq 100KHz$ , $T_J=25^{\circ}C$	--	170	--	$\mu V$	
Ripple Rejection Ratio	RR	$f=120Hz$ , $27V \leq V_{IN} \leq 37V$	54	70	--	dB	
Voltage Drop	$V_{DROP}$	$I_{OUT}=1.0A$ , $T_J=25^{\circ}C$	--	2	--	V	
Output Resistance	$R_{OUT}$	$f=1KHz$	--	28	--	$m\Omega$	
Output Short Circuit Current	$I_{OS}$	$T_J=25^{\circ}C$	--	150	--	mA	
Peak Output Current	$I_{O\ peak}$	$T_J=25^{\circ}C$	--	2.2	--	A	
Temperature Coefficient of Output Voltage	$\Delta V_{OUT} / \Delta T_J$	$I_{OUT}=10mA$ , $0^{\circ}C \leq T_J \leq 125^{\circ}C$	--	-1.5	--	mV/ $^{\circ}C$	

**Note:**

1. Pulse testing techniques are used to maintain the junction temperature as close to the ambient temperature as possible and thermal effects must be taken into account separately.
2. This specification applies only for DC power dissipation permitted by absolute maximum ratings.

**ORDERING INFORMATION**

OUTPUT VOLTAGE	PART NO.	PACKAGE	PACKING
5V	TS7805CZ C0	TO-220	50pcs / Tube
	TS7805CZ C0G	TO-220	50pcs / Tube
8V	TS7808CZ C0	TO-220	50pcs / Tube
	TS7808CZ C0G	TO-220	50pcs / Tube
9V	TS7809CZ C0	TO-220	50pcs / Tube
	TS7809CZ C0G	TO-220	50pcs / Tube
12V	TS7812CZ C0	TO-220	50pcs / Tube
	TS7812CZ C0G	TO-220	50pcs / Tube
24V	TS7824CZ C0	TO-220	50pcs / Tube
	TS7824CZ C0G	TO-220	50pcs / Tube

Not Recommended

**ELECTRICAL CHARACTERISTICS CURVES** ( $T_A=25^\circ\text{C}$ , unless otherwise noted)

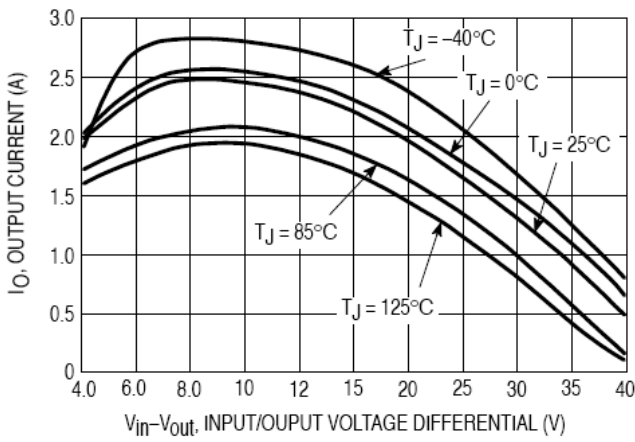

**Figure 1. Peak Output Current as a Function of Input-Output Differential Voltage**

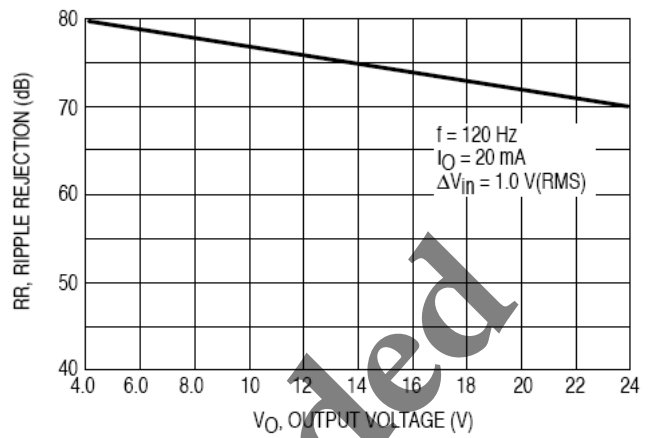

**Figure 2. Ripple Rejection as a Function of Output Voltage**

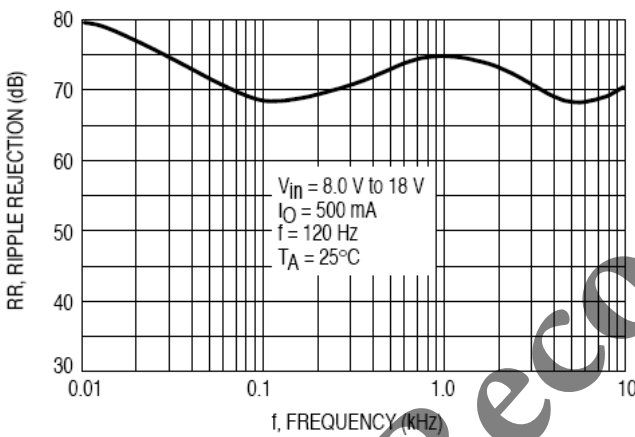

**Figure 3. Ripple Rejection as a Function of Frequency**

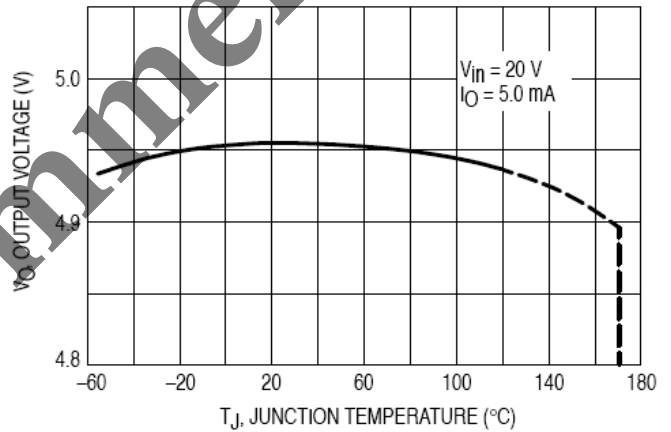

**Figure 4. Output Voltage as a Function of Junction Temperature**

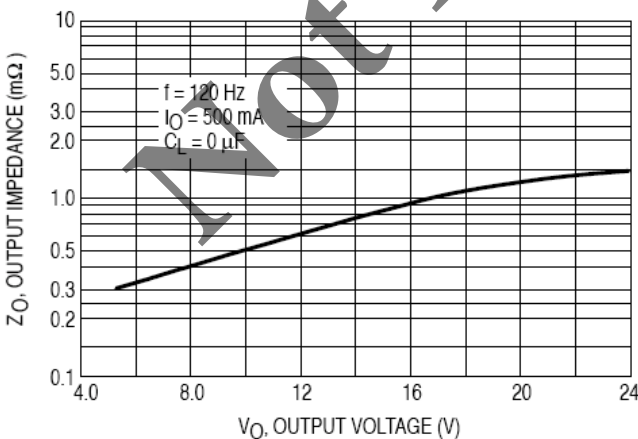

**Figure 5. Output Impedance as a Function of Output Voltage**

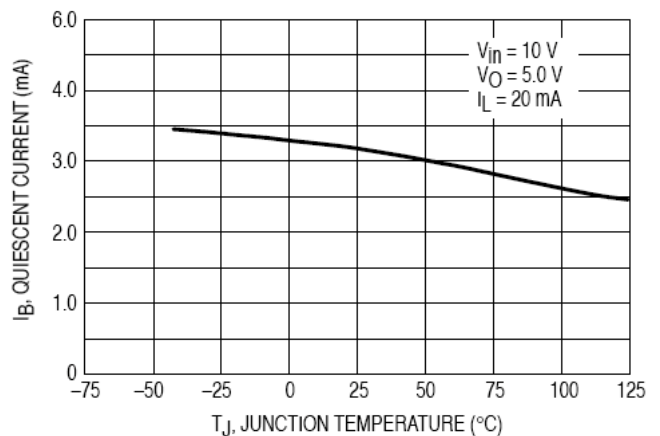

**Figure 6. Quiescent Current as a Function of Temperature**

**PACKAGE OUTLINE DIMENSIONS** (Unit: Millimeters)

**TO-220**

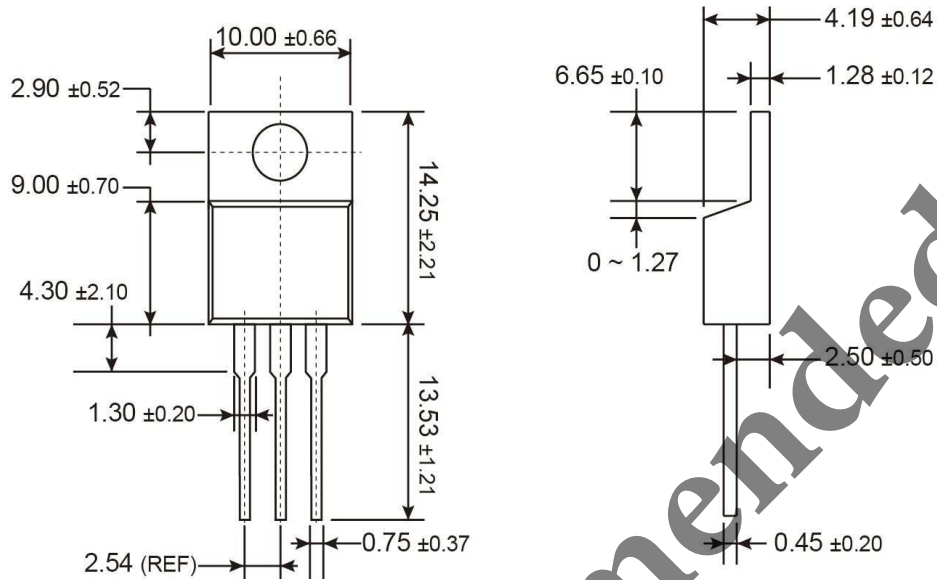

**MARKING DIAGRAM**

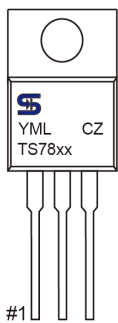

- xx** = Output Voltage Code  
(**05**=5V, **08**=8V, **09**=9V, **12**=12V, **24**=24V)
- Y** = Year Code
- M** = Month Code for Halogen Free Product
  - O** =Jan    **P** =Feb    **Q** =Mar    **R** =Apr
  - S** =May    **T** =Jun    **U** =Jul    **V** =Aug
  - W** =Sep    **X** =Oct    **Y** =Nov    **Z** =Dec
- L** = Lot Code
- CZ** = Package Code for TO-220

**Not Recommended**

### **Notice**

Specifications of the products displayed herein are subject to change without notice. TSC or anyone on its behalf, assumes no responsibility or liability for any errors or inaccuracies.

Information contained herein is intended to provide a product description only. No license, express or implied, to any intellectual property rights is granted by this document. Except as provided in TSC's terms and conditions of sale for such products, TSC assumes no liability whatsoever, and disclaims any express or implied warranty, relating to sale and/or use of TSC products including liability or warranties relating to fitness for a particular purpose, merchantability, or infringement of any patent, copyright, or other intellectual property right.

The products shown herein are not designed for use in medical, life-saving, or life-sustaining applications. Customers using or selling these products for use in such applications do so at their own risk and agree to fully indemnify TSC for any damages resulting from such improper use or sale.



## X-ON Electronics

Largest Supplier of Electrical and Electronic Components

*Click to view similar products for [Linear Voltage Regulators](#) category:*

*Click to view products by [Taiwan Semiconductor](#) manufacturer:*

Other Similar products are found below :

[LV56831P-E](#) [LV5684PVD-XH](#) [MCDTSA6-2R](#) [L7815ACV-DG](#) [LV56801P-E](#) [TCR3DF13,LM\(CT](#) [TCR3DF39,LM\(CT](#) [TLE42794G](#)  
[L78L05CZ/1SX](#) [L78LR05DL-MA-E](#) [LM317T](#) [636416C](#) [714954EB](#) [LV5680P-E](#) [L78M15CV-DG](#) [L79M05T-E](#) [TLS202A1MBVHTSA1](#)  
[L78LR05D-MA-E](#) [NCV317MBTG](#) [NTE7227](#) [NCV78M09BDTRKG](#) [LV5680NPVC-XH](#) [LT1054CN8](#) [ME6208A50M3G](#) [SL7533-8](#)  
[ME6231A50M3G](#) [ME6231A50PG](#) [ME6231C50M5G](#) [AMS1117S-3.3](#) [AMS1117-5.0](#) [AMS1117S-5.0](#) [AMS1117-3.3](#) [MD5118](#) [MD5121](#)  
[MD5127](#) [MD5128](#) [MD5130](#) [MD5144](#) [MD5150](#) [MD5115](#) [MD5125](#) [MD5133](#) [MD5136](#) [MD5140](#) [MD5110](#) [MD52E18WB6](#) [MD52E33WB6](#)  
[MD52E15QA3](#) [MD52E21QA3](#) [MD52E25QA3](#)