

30V N-Channel Power MOSFET

30V, 50A, 9mΩ

FEATURES

- Fast switching
- Halogen Free
- G-S ESD Protection Diode Embedded

APPLICATION

- MB / VGA / Vcore
- POL Applications
- SMPS 2nd SR

KEY PERFORMANCE PARAMETERS		
PARAMETER	VALUE	UNIT
V_{DS}	30	V
$R_{DS(on)}$ (max)	$V_{GS} = 10V$	9
	$V_{GS} = 4.5V$	14
Q_g	7.5	nC



TO-252 (DPAK)

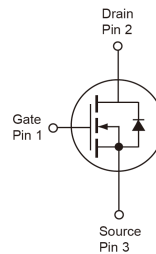
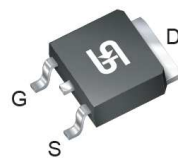

Notes: Moisture sensitivity level: level 3. Per J-STD-020

ABSOLUTE MAXIMUM RATINGS ($T_C = 25^\circ\text{C}$ unless otherwise noted)			
PARAMETER	SYMBOL	LIMIT	UNIT
Drain-Source Voltage	V_{DS}	30	V
Gate-Source Voltage	V_{GS}	± 20	V
Continuous Drain Current	I_D	$T_C = 25^\circ\text{C}$	50
		$T_C = 100^\circ\text{C}$	32
Pulsed Drain Current ^(Note 1)	I_{DM}	200	A
Total Power Dissipation	P_D	$T_C = 25^\circ\text{C}$	40
		Derate above $T_C = 25^\circ\text{C}$	0.32
Single Pulsed Avalanche Energy ^(Note 2)	E_{AS}	45	mJ
Single Pulsed Avalanche Current ^(Note 2)	I_{AS}	30	A
Operating Junction Temperature	T_J	150	$^\circ\text{C}$
Storage Temperature Range	T_{STG}	- 55 to +150	$^\circ\text{C}$

THERMAL PERFORMANCE			
PARAMETER	SYMBOL	LIMIT	UNIT
Junction to Case Thermal Resistance	$R_{\theta JC}$	3.1	$^{\circ}C/W$
Junction to Ambient Thermal Resistance	$R_{\theta JA}$	62	$^{\circ}C/W$

Notes: $R_{\theta JA}$ is the sum of the junction-to-case and case-to-ambient thermal resistances. The case thermal reference is defined at the solder mounting surface of the drain pins. $R_{\theta JA}$ is guaranteed by design while $R_{\theta CA}$ is determined by the user's board design. $R_{\theta JA}$ shown below for single device operation on FR-4 PCB in still air.

ELECTRICAL SPECIFICATIONS ($T_J = 25^{\circ}C$ unless otherwise noted)						
PARAMETER	CONDITIONS	SYMBOL	MIN	TYP	MAX	UNIT
Static (Note3)						
Drain-Source Breakdown Voltage	$V_{GS} = 0V, I_D = 250\mu A$	BV_{DSS}	30	--	--	V
Gate Threshold Voltage	$V_{DS} = V_{GS}, I_D = 250\mu A$	$V_{GS(TH)}$	1.2	1.6	2.5	V
Gate Body Leakage	$V_{GS} = \pm 20V, V_{DS} = 0V$	I_{GSS}	--	--	± 10	μA
Zero Gate Voltage Drain Current	$V_{DS} = 30V, V_{GS} = 0V$	I_{DSS}	--	--	1	μA
	$V_{DS} = 24V, T_J = 125^{\circ}C$		--	--	10	
Forward Transconductance	$V_{DS} = 10V, I_D = 8A$	g_{fs}	--	9.5	--	S
Drain-Source On-State Resistance	$V_{GS} = 10V, I_D = 16A$	$R_{DS(ON)}$	--	7.5	9	m Ω
	$V_{GS} = 4.5V, I_D = 8A$		--	9.6	14	
Dynamic (Note4)						
Total Gate Charge	$V_{DS} = 15V, I_D = 20A,$ $V_{GS} = 4.5V$	Q_g	--	7.7	--	nC
Gate-Source Charge		Q_{gs}	--	1.9	--	
Gate-Drain Charge		Q_{gd}	--	2.8	--	
Input Capacitance	$V_{DS} = 25V, V_{GS} = 0V,$ $f = 1MHz$	C_{iss}	--	680	--	pF
Output Capacitance		C_{oss}	--	150	--	
Reverse Transfer Capacitance		C_{rss}	--	70	--	
Gate Resistance	$V_{GS}=0V, V_{DS}=0V,$ $f=1MHz$	R_g	--	2.7	--	Ω
Switching (Note5)						
Turn-On Delay Time	$V_{DD}=15V, V_{GS}=10V,$ $R_G=3.3\Omega, I_D=-15A$	$t_{d(on)}$	--	4.8	--	ns
Turn-On Rise Time		t_r	--	12.5	--	
Turn-Off Delay Time		$t_{d(off)}$	--	27.6	--	
Turn-Off Fall Time		t_f	--	8.2	--	
Source-Drain Diode (Note3)						
Forward Voltage	$V_{GS} = 0V, I_S = 1A$	V_{SD}	--	--	1	V
Continuous Drain-Source Diode	$V_G=V_D=0V$	I_S	--	--	50	A
Pulse Drain-Source Diode	Force Current	I_{SM}	--	--	200	A

Notes:

1. Repetitive Rating : Pulsed width limited by maximum junction temperature.
2. $V_{DD}=25V, V_{GS}=10V, L=0.1mH, I_{AS}=30A, R_G=25\Omega,$ Starting $T_J=25^{\circ}C$.
3. Pulse test: $PW \leq 300\mu s,$ duty cycle $\leq 2\%$
4. For DESIGN AID ONLY, not subject to production testing.
5. Switching time is essentially independent of operating temperature

ORDERING INFORMATION

PART NO.	PACKAGE	PACKING
TSM090N03ECP ROG	TO-252	2,500pcs / 13" Reel

Note:

1. Compliant to RoHS Directive 2011/65/EU and in accordance to WEEE 2002/96/EC
2. Halogen-free according to IEC 61249-2-21 definition

CHARACTERISTICS CURVES

($T_C = 25^\circ\text{C}$ unless otherwise noted)

Continuous Drain Current vs. T_C

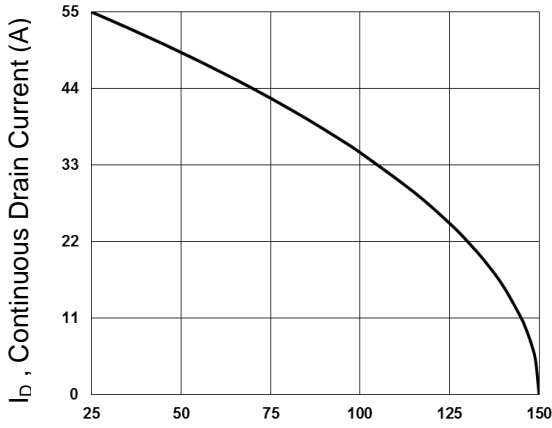

T_C , Case Temperature ($^\circ\text{C}$)

Normalized $R_{DS(on)}$ vs. T_J

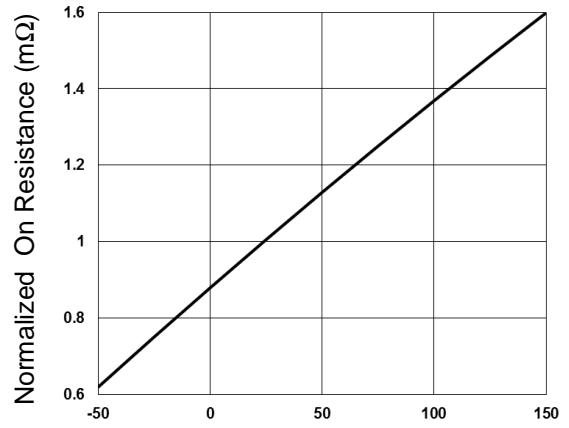

T_J , Junction Temperature ($^\circ\text{C}$)

Normalized V_{th} vs. T_J

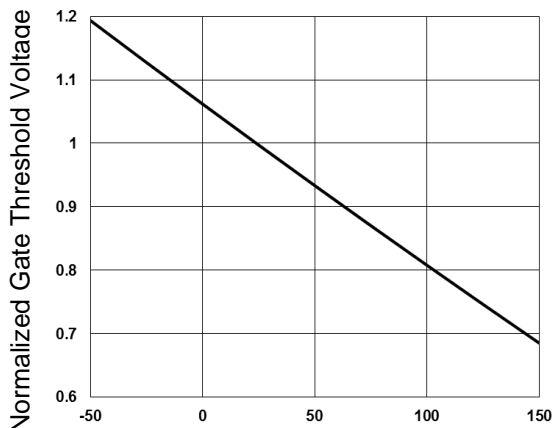

T_J , Junction Temperature ($^\circ\text{C}$)

Gate Charge Waveform

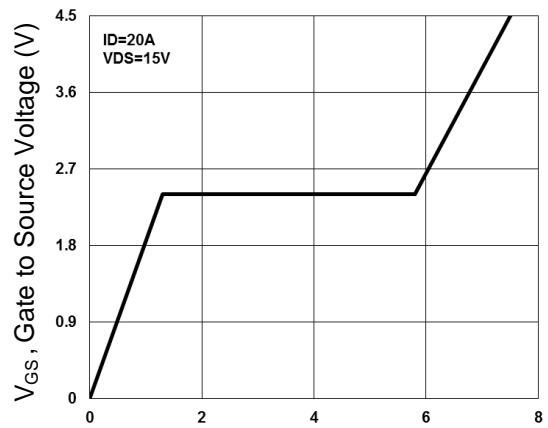

Q_g , Gate Charge (nC)

Normalized Transient Impedance

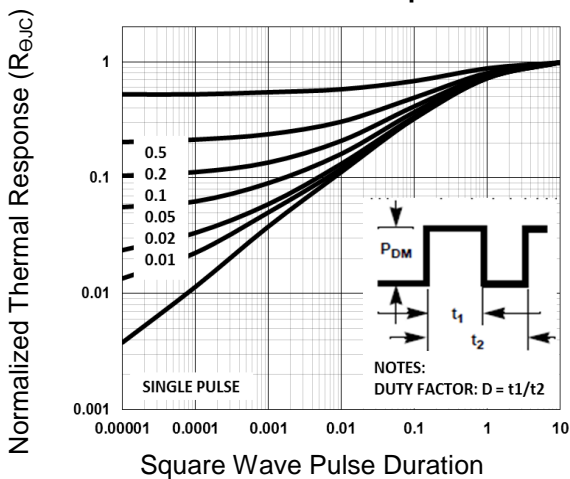

Square Wave Pulse Duration

Maximum Safe Operation Area

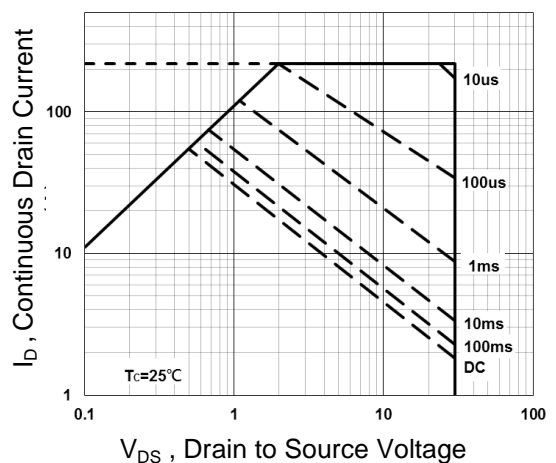

V_{DS} , Drain to Source Voltage

PACKAGE OUTLINE DIMENSIONS (Unit: Millimeters)

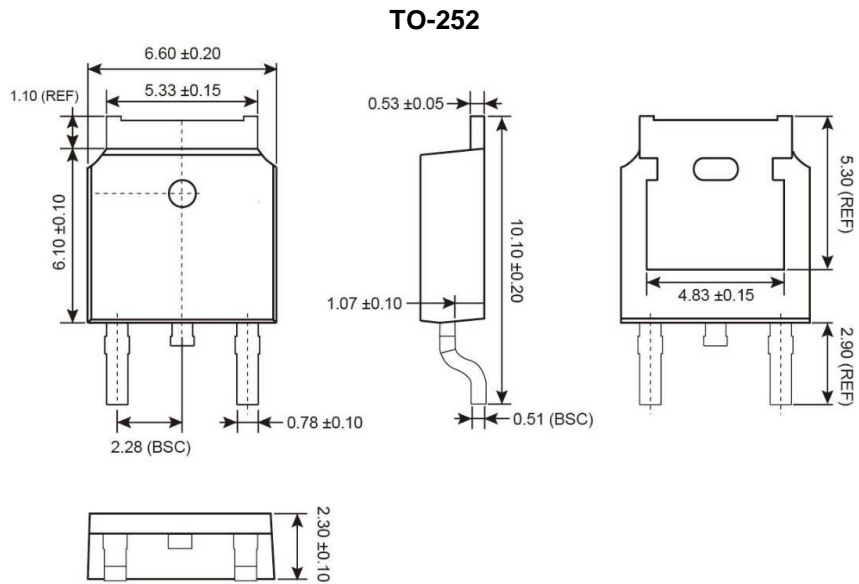

SUGGESTED PAD LAYOUT (Unit: Millimeters)

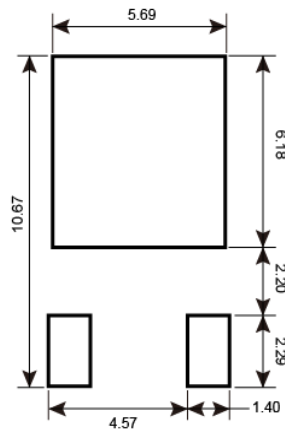

MARKING DIAGRAM

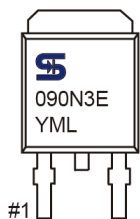

- Y** = Year Code
- M** = Month Code for Halogen Free Product
- O** =Jan **P** =Feb **Q** =Mar **R** =Apr
- S** =May **T** =Jun **U** =Jul **V** =Aug
- W** =Sep **X** =Oct **Y** =Nov **Z** =Dec
- L** = Lot Code

Notice

Specifications of the products displayed herein are subject to change without notice. TSC or anyone on its behalf, assumes no responsibility or liability for any errors or inaccuracies.

Information contained herein is intended to provide a product description only. No license, express or implied, to any intellectual property rights is granted by this document. Except as provided in TSC's terms and conditions of sale for such products, TSC assumes no liability whatsoever, and disclaims any express or implied warranty, relating to sale and/or use of TSC products including liability or warranties relating to fitness for a particular purpose, merchantability, or infringement of any patent, copyright, or other intellectual property right.

The products shown herein are not designed for use in medical, life-saving, or life-sustaining applications. Customers using or selling these products for use in such applications do so at their own risk and agree to fully indemnify TSC for any damages resulting from such improper use or sale.

X-ON Electronics

Largest Supplier of Electrical and Electronic Components

Click to view similar products for [MOSFET](#) category:

Click to view products by [Taiwan Semiconductor](#) manufacturer:

Other Similar products are found below :

[614233C](#) [648584F](#) [IRFD120](#) [JANTX2N5237](#) [FCA20N60_F109](#) [FDZ595PZ](#) [2SK2545\(Q,T\)](#) [405094E](#) [423220D](#) [TPCC8103,L1Q\(CM](#)
[MIC4420CM-TR](#) [VN1206L](#) [SBVS138LT1G](#) [614234A](#) [715780A](#) [NTNS3166NZT5G](#) [SSM6J414TU,LF\(T](#) [751625C](#) [BUK954R8-60E](#)
[DMN3404LQ-7](#) [NTE6400](#) [SQJ402EP-T1-GE3](#) [2SK2614\(TE16L1,Q\)](#) [2N7002KW-FAI](#) [DMN1017UCP3-7](#) [EFC2J004NUZTDG](#) [ECH8691-](#)
[TL-W](#) [FCAB21350L1](#) [P85W28HP2F-7071](#) [DMN1053UCP4-7](#) [NTE221](#) [NTE2384](#) [NTE2903](#) [NTE2941](#) [NTE2945](#) [NTE2946](#) [NTE2960](#)
[NTE2967](#) [NTE2969](#) [NTE2976](#) [NTE455](#) [NTE6400A](#) [NTE2910](#) [NTE2916](#) [NTE2956](#) [NTE2911](#) [DMN2080UCB4-7](#) [TK10A80W,S4X\(S](#)
[SSM6P69NU,LF](#) [DMP22D4UFO-7B](#)