

## N-Channel Power MOSFET

60V, 70A, 12mΩ

### FEATURES

- Low  $R_{DS(on)}$  to minimize conductive losses
- Logic level
- Low gate charge for fast power switching
- 100% UIS and  $R_g$  tested
- Compliant to RoHS directive 2011/65/EU and in accordance to WEEE 2002/96/EC
- Halogen-free according to IEC 61249-2-21

### KEY PERFORMANCE PARAMETERS

PARAMETER	VALUE	UNIT
$V_{DS}$	60	V
$R_{DS(on)}$ (max)	$V_{GS} = 10V$	12
	$V_{GS} = 4.5V$	15
$Q_g$	18	nC

### APPLICATIONS

- BLDC Motor Control
- Battery Power Management
- Secondary Synchronous Rectification



TO-252(DPAK)

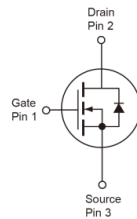
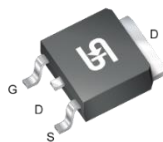

**Notes:** MSL 3 (Moisture Sensitivity Level) per J-STD-020

### ABSOLUTE MAXIMUM RATINGS ( $T_A = 25^\circ\text{C}$ unless otherwise noted)

PARAMETER	SYMBOL	LIMIT	UNIT
Drain-Source Voltage	$V_{DS}$	60	V
Gate-Source Voltage	$V_{GS}$	$\pm 20$	V
Continuous Drain Current	$I_D$	$T_C = 25^\circ\text{C}$	70
		$T_A = 25^\circ\text{C}$	10
Pulsed Drain Current (Note 1)	$I_{DM}$	280	A
Single Pulse Avalanche Current (Note 2)	$I_{AS}$	20	A
Single Pulse Avalanche Energy (Note 2)	$E_{AS}$	60	mJ
Total Power Dissipation	$P_D$	$T_C = 25^\circ\text{C}$	125
		$T_C = 125^\circ\text{C}$	25
Total Power Dissipation	$P_D$	$T_A = 25^\circ\text{C}$	2.6
		$T_A = 125^\circ\text{C}$	0.5
Operating Junction and Storage Temperature Range	$T_J, T_{STG}$	- 55 to +150	$^\circ\text{C}$

### THERMAL PERFORMANCE

PARAMETER	SYMBOL	LIMIT	UNIT
Junction to Case Thermal Resistance	$R_{\theta JC}$	1	$^\circ\text{C/W}$
Junction to Ambient Thermal Resistance	$R_{\theta JA}$	49	$^\circ\text{C/W}$

**Thermal Performance Note:**  $R_{\theta JA}$  is the sum of the junction-to-case and case-to-ambient thermal resistances. The case-thermal reference is defined at the solder mounting surface of the drain pins.  $R_{\theta JA}$  is guaranteed by design while  $R_{\theta CA}$  is determined by the user's board design.

**ELECTRICAL SPECIFICATIONS** ( $T_A = 25^\circ\text{C}$  unless otherwise noted)

PARAMETER	CONDITIONS	SYMBOL	MIN	TYP	MAX	UNIT
<b>Static</b>						
Drain-Source Breakdown Voltage	$V_{GS} = 0V, I_D = 250\mu A$	$BV_{DSS}$	60	--	--	V
Gate Threshold Voltage	$V_{GS} = V_{DS}, I_D = 250\mu A$	$V_{GS(TH)}$	1.2	1.7	2.5	V
Gate-Source Leakage Current	$V_{GS} = \pm 20V, V_{DS} = 0V$	$I_{GSS}$	--	--	$\pm 100$	nA
Drain-Source Leakage Current	$V_{GS} = 0V, V_{DS} = 60V$	$I_{DSS}$	--	--	1	$\mu A$
	$V_{GS} = 0V, V_{DS} = 60V$ $T_J = 125^\circ\text{C}$		--	--	100	
Drain-Source On-State Resistance (Note 3)	$V_{GS} = 10V, I_D = 10A$	$R_{DS(on)}$	--	9.7	12	m $\Omega$
	$V_{GS} = 4.5V, I_D = 10A$		--	11	15	
Forward Transconductance (Note 3)	$V_{DS} = 5V, I_D = 10A$	$g_{fs}$	--	40	--	S
<b>Dynamic</b> (Note 4)						
Total Gate Charge	$V_{GS} = 10V, V_{DS} = 30V,$ $I_D = 10A$	$Q_g$	--	37	--	nC
Total Gate Charge	$V_{GS} = 4.5V, V_{DS} = 30V,$ $I_D = 10A$	$Q_g$	--	18	--	
Gate-Source Charge		$Q_{gs}$	--	6	--	
Gate-Drain Charge		$Q_{gd}$	--	7.5	--	
Input Capacitance	$V_{GS} = 0V, V_{DS} = 30V$ $f = 1.0\text{MHz}$	$C_{iss}$	--	2118	--	pF
Output Capacitance		$C_{oss}$	--	136	--	
Reverse Transfer Capacitance		$C_{rss}$	--	86	--	
Gate Resistance	$f = 1.0\text{MHz}, \text{open drain}$	$R_g$	0.5	1.6	3.2	$\Omega$
<b>Switching</b> (Note 4)						
Turn-On Delay Time	$V_{GS} = 10V, V_{DS} = 30V,$ $I_D = 10A, R_G = 2\Omega,$	$t_{d(on)}$	--	6.4	--	ns
Turn-On Rise Time		$t_r$	--	13.4	--	
Turn-Off Delay Time		$t_{d(off)}$	--	25.6	--	
Turn-Off Fall Time		$t_f$	--	6.6	--	
<b>Source-Drain Diode</b>						
Forward Voltage (Note 3)	$V_{GS} = 0V, I_S = 10A$	$V_{SD}$	--	--	1	V
Reverse Recovery Time	$I_S = 10A,$ $di/dt = 100A/\mu s$	$t_{rr}$	--	17	--	ns
Reverse Recovery Charge		$Q_{rr}$	--	13	--	nC

**Notes:**

- Current limited by package.
- $L = 0.3\text{mH}, V_{GS} = 10V, V_{DD} = 30V, R_G = 25\Omega, I_{AS} = 20A,$  Starting  $T_J = 25^\circ\text{C}$
- Pulse test: Pulse Width  $\leq 300\mu s,$  duty cycle  $\leq 2\%$ .
- Switching time is essentially independent of operating temperature.

**ORDERING INFORMATION**

PART NO.	PACKAGE	PACKING
TSM120N06LCP ROG	TO-252(DPAK)	2,500pcs / 13" Reel

**CHARACTERISTICS CURVES**

( $T_A = 25^\circ\text{C}$  unless otherwise noted)

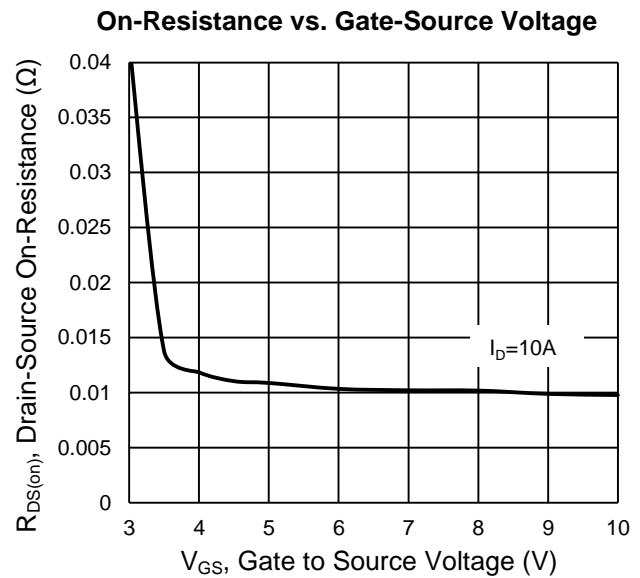
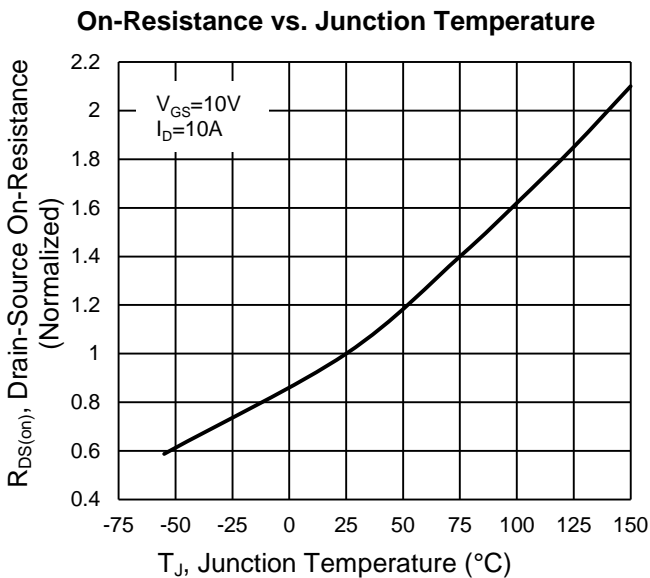
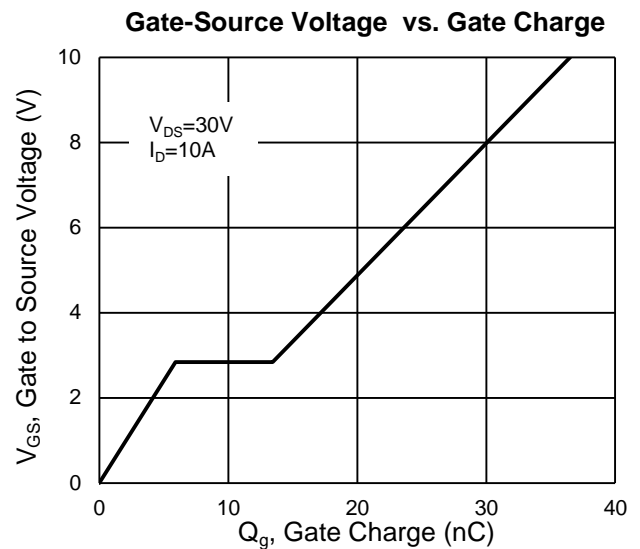
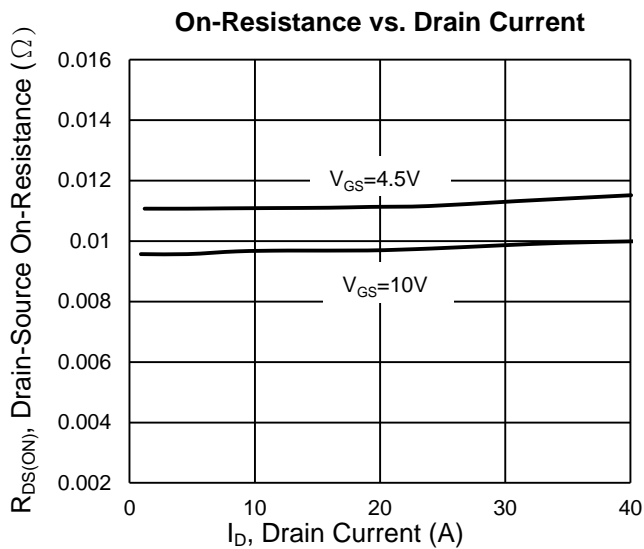
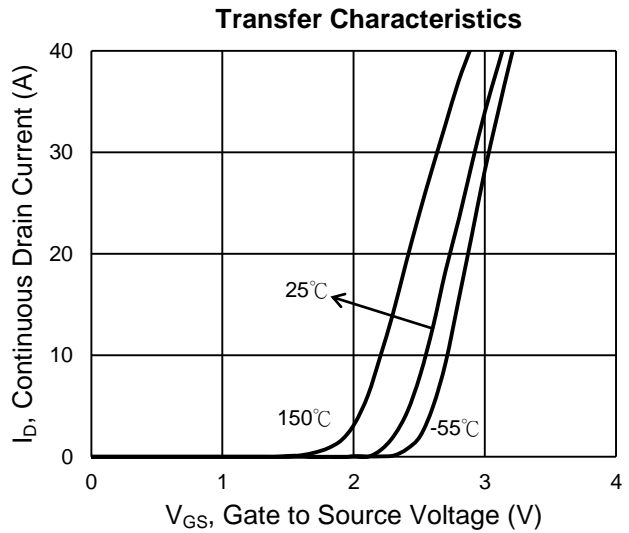
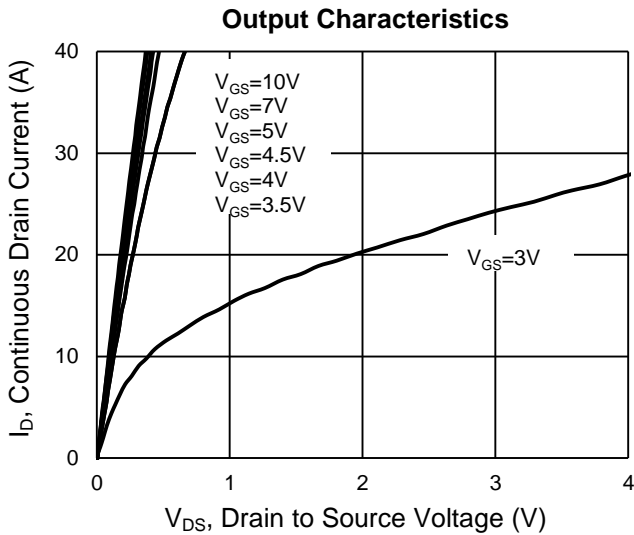

**CHARACTERISTICS CURVES**

( $T_A = 25^\circ\text{C}$  unless otherwise noted)

**Capacitance vs. Drain-Source Voltage**

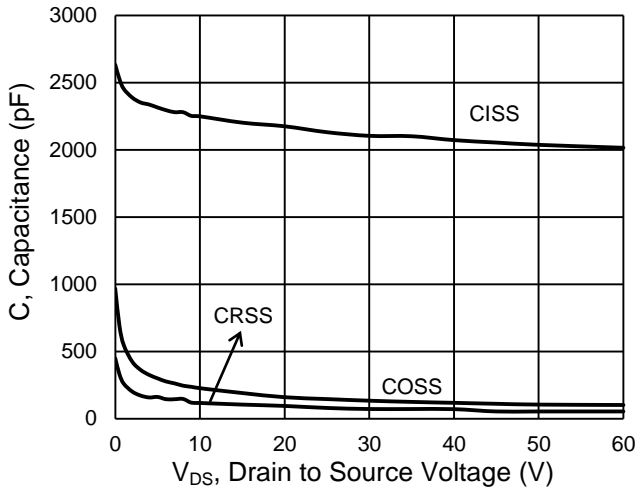

**$BV_{DSS}$  vs. Junction Temperature**

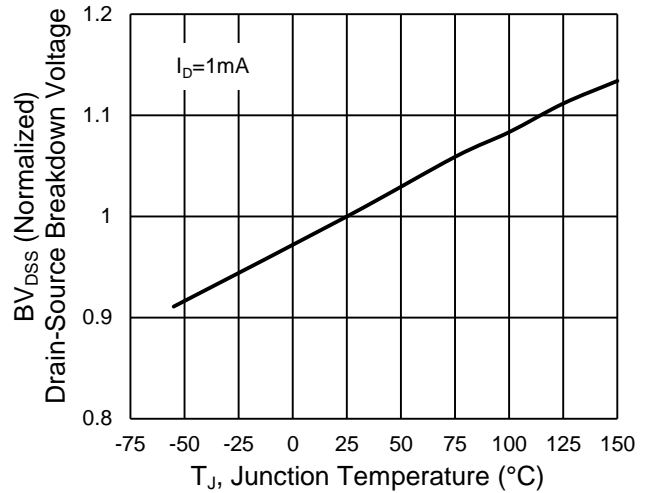

**Maximum Safe Operating Area, Junction-to-Case**

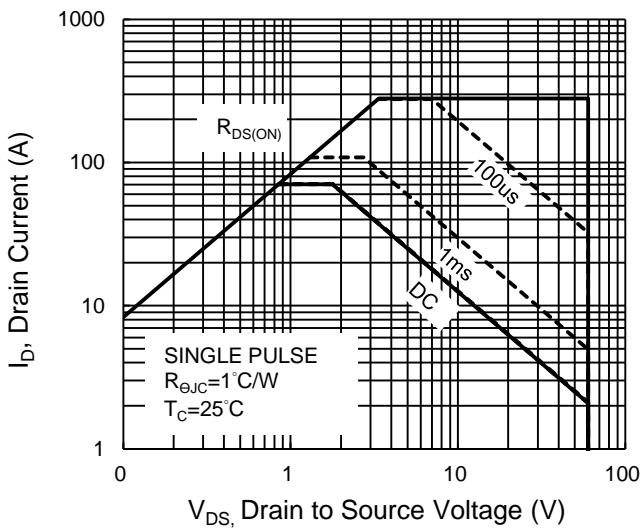

**Source-Drain Diode Forward Current vs. Voltage**

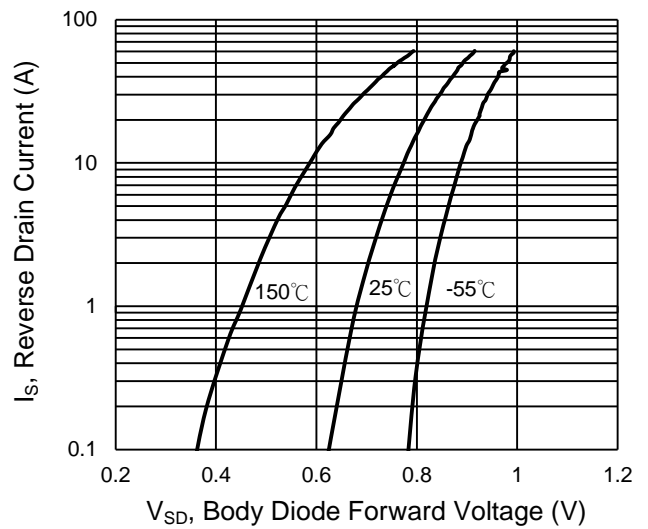

**Normalized Thermal Transient Impedance, Junction-to-Case**

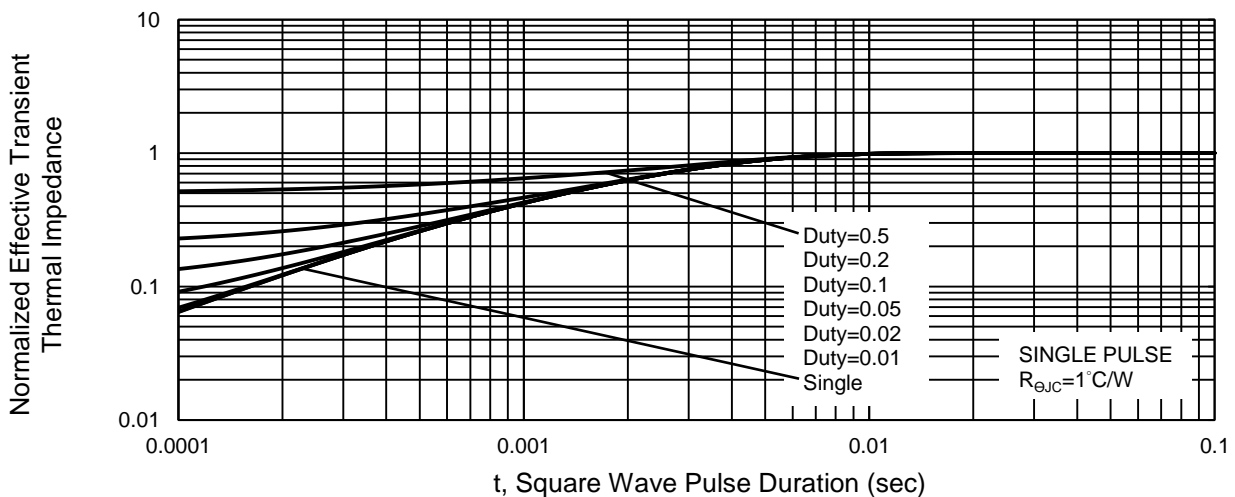

**PACKAGE OUTLINE DIMENSIONS** (Unit: Millimeters)

**TO-252(DPAK)**

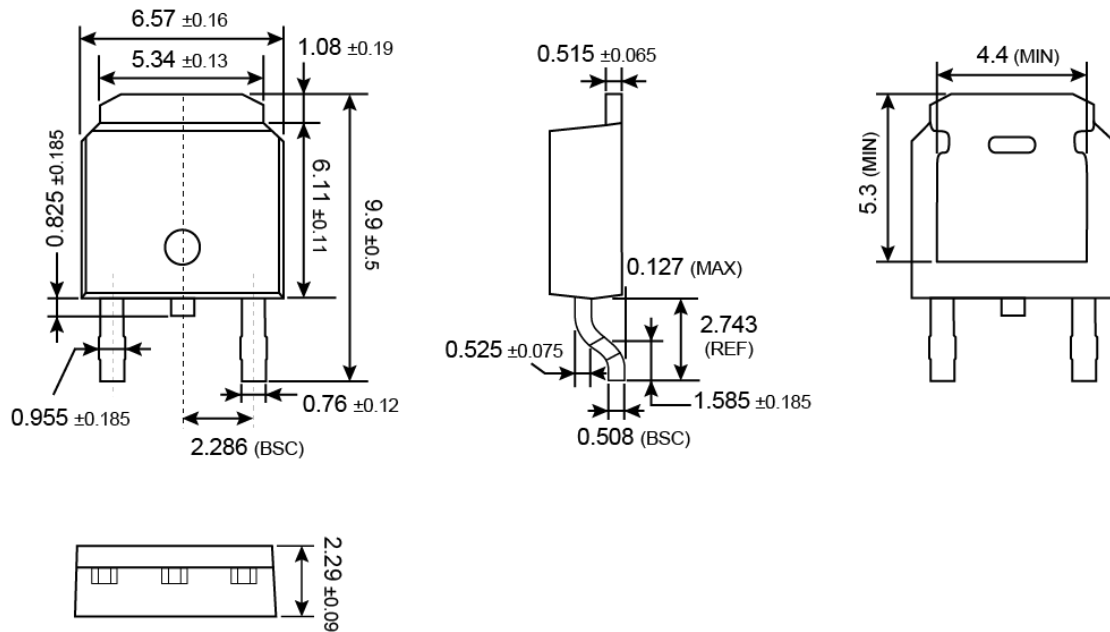

**SUGGESTED PAD LAYOUT** (Unit: Millimeters)

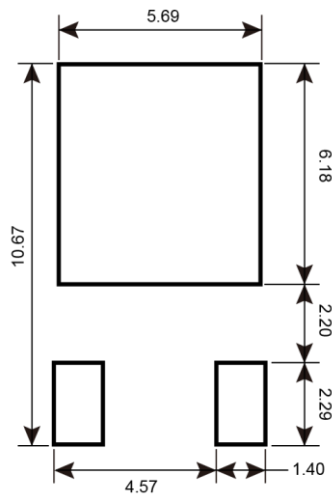

**MARKING DIAGRAM**

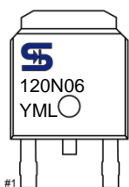

- Y = Year Code
- M = Month Code for Halogen Free Product
- O =Jan    P =Feb    Q =Mar    R =Apr
- S =May    T =Jun    U =Jul    V =Aug
- W =Sep    X =Oct    Y =Nov    Z =Dec
- L = Lot Code (1~9, A~Z)

## Notice

Specifications of the products displayed herein are subject to change without notice. TSC or anyone on its behalf, assumes no responsibility or liability for any errors or inaccuracies.

Information contained herein is intended to provide a product description only. No license, express or implied, to any intellectual property rights is granted by this document. Except as provided in TSC's terms and conditions of sale for such products, TSC assumes no liability whatsoever, and disclaims any express or implied warranty, relating to sale and/or use of TSC products including liability or warranties relating to fitness for a particular purpose, merchantability, or infringement of any patent, copyright, or other intellectual property right.

The products shown herein are not designed for use in medical, life-saving, or life-sustaining applications. Customers using or selling these products for use in such applications do so at their own risk and agree to fully indemnify TSC for any damages resulting from such improper use or sale.

## X-ON Electronics

Largest Supplier of Electrical and Electronic Components

*Click to view similar products for [MOSFET](#) category:*

*Click to view products by [Taiwan Semiconductor](#) manufacturer:*

Other Similar products are found below :

[614233C](#) [648584F](#) [IRFD120](#) [JANTX2N5237](#) [2N7000](#) [FCA20N60\\_F109](#) [FDZ595PZ](#) [2SK2545\(Q,T\)](#) [405094E](#) [423220D](#)  
[TPCC8103,L1Q\(CM](#) [MIC4420CM-TR](#) [VN1206L](#) [614234A](#) [715780A](#) [NTNS3166NZT5G](#) [SSM6J414TU,LF\(T](#) [751625C](#)  
[IPS70R2K0CEAKMA1](#) [BUK954R8-60E](#) [DMN3404LQ-7](#) [NTE6400](#) [SQJ402EP-T1-GE3](#) [2SK2614\(TE16L1,Q\)](#) [2N7002KW-FAI](#)  
[DMN1017UCP3-7](#) [EFC2J004NUZTDG](#) [ECH8691-TL-W](#) [FCAB21350L1](#) [P85W28HP2F-7071](#) [DMN1053UCP4-7](#) [NTE221](#) [NTE2384](#)  
[NTE2903](#) [NTE2941](#) [NTE2945](#) [NTE2946](#) [NTE2960](#) [NTE2967](#) [NTE2969](#) [NTE2976](#) [NTE455](#) [NTE6400A](#) [NTE2910](#) [NTE2916](#) [NTE2956](#)  
[NTE2911](#) [TK10A80W,S4X\(S](#) [SSM6P69NU,LF](#) [DMP22D4UFO-7B](#)