

# Notice for TAIYO YUDEN products

Please read this notice before using the TAIYO YUDEN products.

## ⚠️ REMINDERS

### ■ Product Information in this Catalog

Product information in this catalog is as of October 2019. All of the contents specified herein and production status of the products listed in this catalog are subject to change without notice due to technical improvement of our products, etc. Therefore, please check for the latest information carefully before practical application or use of our products.

Please note that TAIYO YUDEN shall not be in any way responsible for any damages and defects in products or equipment incorporating our products, which are caused under the conditions other than those specified in this catalog or individual product specification sheets.

### ■ Approval of Product Specifications

Please contact TAIYO YUDEN for further details of product specifications as the individual product specification sheets are available. When using our products, please be sure to approve our product specifications or make a written agreement on the product specification with TAIYO YUDEN in advance.

### ■ Pre-Evaluation in the Actual Equipment and Conditions

Please conduct validation and verification of our products in actual conditions of mounting and operating environment before using our products.

### ■ Limited Application

#### 1. Equipment Intended for Use

The products listed in this catalog are intended for general-purpose and standard use in general electronic equipment (e.g., AV equipment, OA equipment, home electric appliances, office equipment, information and communication equipment including, without limitation, mobile phone, and PC) and other equipment specified in this catalog or the individual product specification sheets.

TAIYO YUDEN has the line-up of the products intended for use in automotive electronic equipment, telecommunications infrastructure and industrial equipment, or medical devices classified as GHTF Classes A to C (Japan Classes I to III). Therefore, when using our products for these equipment, please check available applications specified in this catalog or the individual product specification sheets and use the corresponding products.

#### 2. Equipment Requiring Inquiry

Please be sure to contact TAIYO YUDEN for further information before using the products listed in this catalog for the following equipment (excluding intended equipment as specified in this catalog or the individual product specification sheets) which may cause loss of human life, bodily injury, serious property damage and/or serious public impact due to a failure or defect of the products and/or malfunction attributed thereto.

- (1) Transportation equipment (automotive powertrain control system, train control system, and ship control system, etc.)
- (2) Traffic signal equipment
- (3) Disaster prevention equipment, crime prevention equipment
- (4) Medical devices classified as GHTF Class C (Japan Class III)
- (5) Highly public information network equipment, data-processing equipment (telephone exchange, and base station, etc.)
- (6) Any other equipment requiring high levels of quality and/or reliability equal to the equipment listed above

#### 3. Equipment Prohibited for Use

Please do not incorporate our products into the following equipment requiring extremely high levels of safety and/or reliability.

- (1) Aerospace equipment (artificial satellite, rocket, etc.)
- (2) Aviation equipment \*<sup>1</sup>
- (3) Medical devices classified as GHTF Class D (Japan Class IV), implantable medical devices \*<sup>2</sup>

- (4) Power generation control equipment (nuclear power, hydroelectric power, thermal power plant control system, etc.)
- (5) Undersea equipment (submarine repeating equipment, underwater work equipment, etc.)
- (6) Military equipment
- (7) Any other equipment requiring extremely high levels of safety and/or reliability equal to the equipment listed above

\*Notes:

1. There is a possibility that our products can be used only for aviation equipment that does not directly affect the safe operation of aircraft (e.g., in-flight entertainment, cabin light, electric seat, cooking equipment) if such use meets requirements specified separately by TAIYO YUDEN. Please be sure to contact TAIYO YUDEN for further information before using our products for such aviation equipment.
2. Implantable medical devices contain not only internal unit which is implanted in a body, but also external unit which is connected to the internal unit.

#### 4. Limitation of Liability

Please note that unless you obtain prior written consent of TAIYO YUDEN, TAIYO YUDEN shall not be in any way responsible for any damages incurred by you or third parties arising from use of the products listed in this catalog for any equipment that is not intended for use by TAIYO YUDEN, or any equipment requiring inquiry to TAIYO YUDEN or prohibited for use by TAIYO YUDEN as described above.

### ■ Safety Design

When using our products for high safety and/or reliability-required equipment or circuits, please fully perform safety and/or reliability evaluation. In addition, please install (i) systems equipped with a protection circuit and a protection device and/or (ii) systems equipped with a redundant circuit or other system to prevent an unsafe status in the event of a single fault for a failsafe design to ensure safety.

### ■ Intellectual Property Rights

Information contained in this catalog is intended to convey examples of typical performances and/or applications of our products and is not intended to make any warranty with respect to the intellectual property rights or any other related rights of TAIYO YUDEN or any third parties nor grant any license under such rights.

### ■ Limited Warranty

Please note that the scope of warranty for our products is limited to the delivered our products themselves and TAIYO YUDEN shall not be in any way responsible for any damages resulting from a failure or defect in our products. Notwithstanding the foregoing, if there is a written agreement (e.g., supply and purchase agreement, quality assurance agreement) signed by TAIYO YUDEN and your company, TAIYO YUDEN will warrant our products in accordance with such agreement.

### ■ TAIYO YUDEN's Official Sales Channel

The contents of this catalog are applicable to our products which are purchased from our sales offices or authorized distributors (hereinafter "TAIYO YUDEN's official sales channel"). Please note that the contents of this catalog are not applicable to our products purchased from any seller other than TAIYO YUDEN's official sales channel.

### ■ Caution for Export

Some of our products listed in this catalog may require specific procedures for export according to "U.S. Export Administration Regulations", "Foreign Exchange and Foreign Trade Control Law" of Japan, and other applicable regulations. Should you have any questions on this matter, please contact our sales staff.

# MULTILAYER CHIP POWER INDUCTORS (CK SERIES P TYPE)

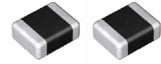

WAVE

REFLOW

■ PARTS NUMBER

\* Operating Temp.: -40~+85°C

C	K	P	2	5	2	0	V	1	R	0	M	-	T	△
①	②	③	④	⑤	⑥	⑦								

△=Blank space

① Series name

Code	Series name
CKP	Multilayer chip power inductor

② Dimensions (L × W)

Code	Type (inch)	Dimensions (L × W) [mm]
1608	1608(0603)	1.6 × 0.8
2012	2012(0805)	2.0 × 1.25
2016	2016(0806)	2.0 × 1.6
2520	2520(1008)	2.5 × 2.0

③ Thickness

Code	Thickness [mm]
V	1.2 max
△	1.0 max
N	
C	
E	
D	0.95 max
M	0.8 max

④ Nominal inductance

Code (example)	Nominal inductance [μH]
1R0	1.0
R82	0.82

※R=Decimal point

⑤ Inductance tolerance

Code	Inductance tolerance
M	±20%

⑥ Packaging

Code	Packaging
-T	Taping

⑦ Internal code

Code	Internal code
△	Standard

■ STANDARD EXTERNAL DIMENSIONS / STANDARD QUANTITY

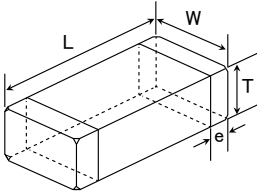

Type	L	W	T	e	Standard quantity [pcs]	
					Paper tape	Embossed tape
CKP1608 (0603)	1.6 ± 0.15 (0.063 ± 0.006)	0.8 ± 0.15 (0.031 ± 0.006)	0.95 max (0.037 max)	0.3 ± 0.2 (0.012 ± 0.008)	4000	—
CKP2012 (0805)	2.0 ± 0.2 (0.079 ± 0.008)	1.25 ± 0.2 (0.049 ± 0.008)	1.0 max (0.039 max)	0.5 ± 0.3 (0.02 ± 0.012)	—	3000
CKP2016 (0806)	2.0 ± 0.2 (0.079 ± 0.008)	1.6 ± 0.2 (0.063 ± 0.008)	1.0 max (0.039 max)	0.5 ± 0.3 (0.02 ± 0.012)	—	3000
CKP2520 (1008)	2.5 ± 0.2 (0.098 ± 0.008)	2.0 ± 0.2 (0.079 ± 0.008)	0.8 max (0.031 max)	0.5 ± 0.3 (0.02 ± 0.012)	—	3000
	2.5 ± 0.2 (0.098 ± 0.008)	2.0 ± 0.2 (0.079 ± 0.008)	1.0 max (0.039 max)	0.5 ± 0.3 (0.02 ± 0.012)	—	3000
	2.5 ± 0.2 (0.098 ± 0.008)	2.0 ± 0.2 (0.079 ± 0.008)	1.2 max (0.047 max)	0.5 ± 0.3 (0.02 ± 0.012)	—	2000

Unit: mm (inch)

▶ This catalog contains the typical specification only due to the limitation of space. When you consider the purchase of our products, please check our product specification sheets. For details of each product (characteristics graph, reliability information, precautions for use, and so on), see our website (<http://www.ty-top.com/>).

## PARTS NUMBER

## ● CKP1608

Parts number	EHS	Nominal inductance [ $\mu$ H]	Inductance tolerance	DC Resistance [ $\Omega$ ]		Rated current [A] (max.)	Measuring frequency [MHz]	Thickness [mm] (max.)
				(max.)	(typ.)			
CKP1608DR50M-T	RoHS	0.5	$\pm 20\%$	0.15	0.12	0.9	1	0.95
CKP1608D1R0M-T	RoHS	1.0	$\pm 20\%$	0.20	0.17	0.75	1	0.95
CKP1608D2R2M-T	RoHS	2.2	$\pm 20\%$	0.30	0.27	0.65	1	0.95

## ● CKP2012

Parts number	EHS	Nominal inductance [ $\mu$ H]	Inductance tolerance	DC Resistance [ $\Omega$ ]		Rated current [A] (max.)	Measuring frequency [MHz]	Thickness [mm] (max.)
				(max.)	(typ.)			
CKP2012NR47M-T	RoHS	0.47	$\pm 20\%$	0.08	0.06	1.2	1	1.0
CKP2012N1R0M-T	RoHS	1.0	$\pm 20\%$	0.14	0.11	1.0	1	1.0
CKP2012N1R5M-T	RoHS	1.5	$\pm 20\%$	0.20	0.15	0.8	1	1.0
CKP2012N2R2M-T	RoHS	2.2	$\pm 20\%$	0.20	0.15	0.8	1	1.0
CKP2012N3R3M-T	RoHS	3.3	$\pm 20\%$	0.24	0.20	0.7	1	1.0
CKP2012N4R7M-T	RoHS	4.7	$\pm 20\%$	0.28	0.23	0.7	1	1.0
CKP2012E1R0M-T	RoHS	1.0	$\pm 20\%$	0.10	0.08	1.7	1	1.0
CKP2012E2R2M-T	RoHS	2.2	$\pm 20\%$	0.16	0.12	1.3	1	1.0

## ● CKP2016

Parts number	EHS	Nominal inductance [ $\mu$ H]	Inductance tolerance	DC Resistance [ $\Omega$ ]		Rated current [A] (max.)	Measuring frequency [MHz]	Thickness [mm] (max.)
				(max.)	(typ.)			
CKP2016 R47M-T	RoHS	0.47	$\pm 20\%$	0.075	0.06	1.6	1	1.0
CKP2016 1R0M-T	RoHS	1.0	$\pm 20\%$	0.12	0.09	1.3	1	1.0
CKP2016 1R5M-T	RoHS	1.5	$\pm 20\%$	0.13	0.10	1.2	1	1.0
CKP2016 2R2M-T	RoHS	2.2	$\pm 20\%$	0.14	0.11	1.2	1	1.0
CKP2016 3R3M-T	RoHS	3.3	$\pm 20\%$	0.16	0.13	1.1	1	1.0
CKP2016 4R7M-T	RoHS	4.7	$\pm 20\%$	0.20	0.16	0.9	1	1.0

## ● CKP2520

Parts number	EHS	Nominal inductance [ $\mu$ H]	Inductance tolerance	DC Resistance [ $\Omega$ ]		Rated current [A] (max.)	Measuring frequency [MHz]	Thickness [mm] (max.)
				(max.)	(typ.)			
CKP2520M1R5M-T	RoHS	1.5	$\pm 20\%$	0.09	0.075	1.3	1	0.8
CKP2520M2R2M-T	RoHS	2.2	$\pm 20\%$	0.10	0.08	1.2	1	0.8
CKP2520 R47M-T	RoHS	0.47	$\pm 20\%$	0.05	0.04	1.8	1	1.0
CKP2520 1R0M-T	RoHS	1.0	$\pm 20\%$	0.08	0.065	1.4	1	1.0
CKP2520 1R5M-T	RoHS	1.5	$\pm 20\%$	0.09	0.075	1.3	1	1.0
CKP2520 2R2M-T	RoHS	2.2	$\pm 20\%$	0.09	0.075	1.3	1	1.0
CKP2520 3R3M-T	RoHS	3.3	$\pm 20\%$	0.12	0.09	1.2	1	1.0
CKP2520 4R7M-T	RoHS	4.7	$\pm 20\%$	0.15	0.12	1.1	1	1.0
CKP2520C1R0M-T	RoHS	1.0	$\pm 20\%$	0.08	0.06	1.4	1	1.0
CKP2520N1R0M-T	RoHS	1.0	$\pm 20\%$	0.115	0.09	1.2	1	1.0
CKP2520N2R2M-T	RoHS	2.2	$\pm 20\%$	0.115	0.09	1.2	1	1.0
CKP2520N4R7M-T	RoHS	4.7	$\pm 20\%$	0.16	0.14	1.1	1	1.0
CKP2520V1R0M-T	RoHS	1.0	$\pm 20\%$	0.12	0.09	1.2	1	1.2
CKP2520V2R2M-T	RoHS	2.2	$\pm 20\%$	0.15	0.12	1.1	1	1.2
CKP2520V3R3M-T	RoHS	3.3	$\pm 20\%$	0.15	0.11	1.1	1	1.2
CKP2520V4R7M-T	RoHS	4.7	$\pm 20\%$	0.16	0.14	1.1	1	1.2

※ Rated current specifies that self-heat generation is below 40 degC during DC loaded (at 20 degC).

# Multilayer chip inductors

Multilayer chip inductors for high frequency, Multilayer chip bead inductors

Multilayer common mode choke coils (MC series F type)

Metal Multilayer Chip Power Inductors (MCOIL™ MC series)

## ■ PACKAGING

### ① Minimum Quantity

#### ● Tape & Reel Packaging

Type	Thickness mm (inch)	Standard Quantity [pcs]	
		Paper Tape	Embossed Tape
CK1608(0603)	0.8 (0.031)	4000	—
CK2125(0805)	0.85(0.033)	4000	—
	1.25(0.049)	—	2000
CKS2125(0805)	0.85(0.033)	4000	—
	1.25(0.049)	—	2000
CKP1608(0603)	0.8 (0.031)	4000	—
CKP2012(0805)	0.9 (0.035)	—	3000
CKP2016(0806)	0.9 (0.035)	—	3000
CKP2520(1008)	0.7 (0.028)	—	3000
	0.9 (0.035)	—	3000
	1.1 (0.043)	—	2000
LK1005(0402)	0.5 (0.020)	10000	—
LK1608(0603)	0.8 (0.031)	4000	—
LK2125(0805)	0.85(0.033)	4000	—
	1.25(0.049)	—	2000
HK0603(0201)	0.3 (0.012)	15000	—
HK1005(0402)	0.5 (0.020)	10000	—
HK1608(0603)	0.8 (0.031)	4000	—
HK2125(0805)	0.85(0.033)	—	4000
	1.0 (0.039)	—	3000
HKQ0603S(0201)	0.3 (0.012)	15000	—
HKQ0603U(0201)	0.3 (0.012)	15000	—
AQ105(0402)	0.5 (0.020)	10000	—
BK0603(0201)	0.3 (0.012)	15000	—
BK1005(0402)	0.5 (0.020)	10000	—
BKH0603(0201)	0.3 (0.012)	15000	—
BKH1005(0402)	0.5 (0.020)	10000	—
BK1608(0603)	0.8 (0.031)	4000	—
BK2125(0805)	0.85(0.033)	4000	—
	1.25(0.049)	—	2000
BK2010(0804)	0.45(0.018)	4000	—
BK3216(1206)	0.8 (0.031)	—	4000
BKP0603(0201)	0.3 (0.012)	15000	—
BKP1005(0402)	0.5 (0.020)	10000	—
BKP1608(0603)	0.8 (0.031)	4000	—
BKP2125(0805)	0.85(0.033)	4000	—
MCF0605(0202)	0.3 (0.012)	15000	—
MCF0806(0302)	0.4 (0.016)	—	10000
MCF1210(0504)	0.55(0.022)	—	5000
MCF2010(0804)	0.45(0.018)	—	4000
MCEE1005(0402)	0.55(0.022)	10000	—
MCEK1210(0504)	0.5 (0.020)	5000	—
MCFK1608(0603)	0.6 (0.024)	4000	—
MCFE1608(0603)	0.65(0.026)	4000	—
MCHK1608(0603)	0.8 (0.031)	4000	—
MCKK1608(0603)	1.0 (0.039)	—	3000
MCHK2012(0806)	0.8 (0.031)	4000	—
MCKK2012(0805)	1.0 (0.039)	—	3000

▶ This catalog contains the typical specification only due to the limitation of space. When you consider the purchase of our products, please check our specification. For details of each product (characteristics graph, reliability information, precautions for use, and so on), see our Web site (<http://www.ty-top.com/>).

## ② Taping material

### ● Card board carrier tape

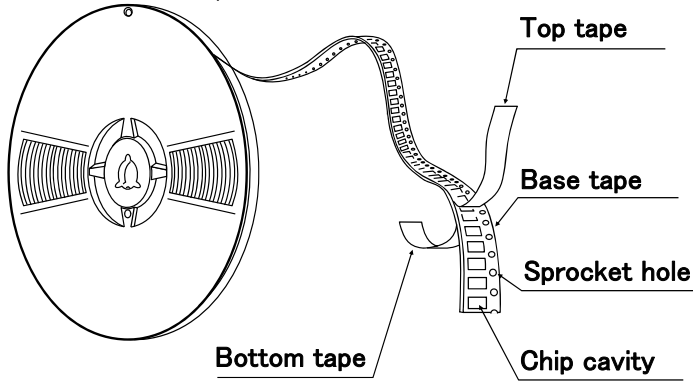

CK	1608
CKP	1608
CK	2125
CKS	2125
LK	1005
LK	1608
LK	2125
HK	0603
HK	1005
HK	1608
HKQ	0603
AQ	105

BK	0603
BK	1005
BK	1608
BK	2125
BK	2010
BKP	0603
BKP	1005
BKP	1608
BKP	2125
BKH	0603
BKH	1005
MCF	0605
MC	1005
MC	1210
MC	1608
MC	2012

### Chip Filled

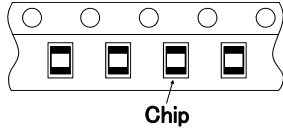

### ● Embossed Tape

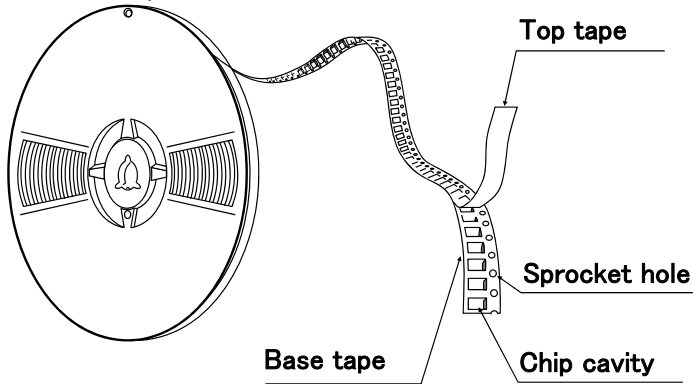

CK	2125
CKS	2125
CKP	2012
CKP	2016
CKP	2520
LK	2125
HK	2125

BK	2125
BK	3216
MCF	0806
MCF	1210
MCF	2010
MC	1608
MC	2012

### Chip Filled

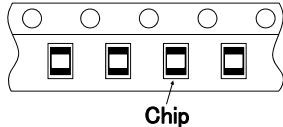

## ③ Taping Dimensions

### ● Paper tape (8mm wide)

Unit: mm (inch)

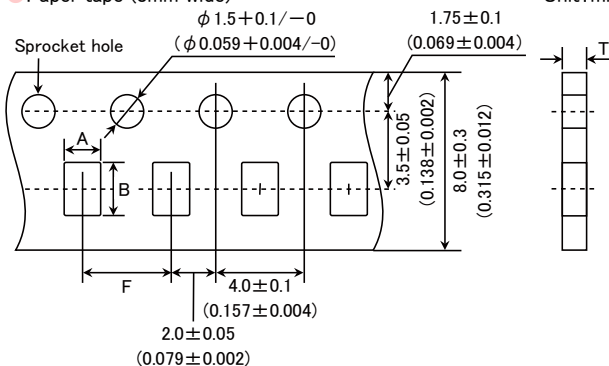

▶ This catalog contains the typical specification only due to the limitation of space. When you consider the purchase of our products, please check our specification. For details of each product (characteristics graph, reliability information, precautions for use, and so on), see our Web site (<http://www.ty-top.com/>).

Type	Thickness mm (inch)	Chip cavity		Insertion Pitch	Tape Thickness
		A	B	F	T
CK1608(0603)	0.8 (0.031)	1.0±0.2 (0.039±0.008)	1.8±0.2 (0.071±0.008)	4.0±0.1 (0.157±0.004)	1.1max (0.043max)
CK2125(0805)	0.85(0.033)	1.5±0.2 (0.059±0.008)	2.3±0.2 (0.091±0.008)	4.0±0.1 (0.157±0.004)	1.1max (0.043max)
CKS2125(0805)	0.85(0.033)	1.5±0.2 (0.059±0.008)	2.3±0.2 (0.091±0.008)	4.0±0.1 (0.157±0.004)	1.1max (0.043max)
CKP1608(0603)	0.8 (0.031)	1.0±0.2 (0.039±0.008)	1.8±0.2 (0.071±0.008)	4.0±0.1 (0.157±0.004)	1.1max (0.043max)
LK1005(0402)	0.5 (0.020)	0.65±0.1 (0.026±0.004)	1.15±0.1 (0.045±0.004)	2.0±0.05 (0.079±0.002)	0.8max (0.031max)
LK1608(0603)	0.8 (0.031)	1.0±0.2 (0.039±0.008)	1.8±0.2 (0.071±0.008)	4.0±0.1 (0.157±0.004)	1.1max (0.043max)
LK2125(0805)	0.85(0.033)	1.5±0.2 (0.059±0.008)	2.3±0.2 (0.091±0.008)	4.0±0.1 (0.157±0.004)	1.1max (0.043max)
HK0603(0201)	0.3 (0.012)	0.40±0.06 (0.016±0.002)	0.70±0.06 (0.028±0.002)	2.0±0.05 (0.079±0.002)	0.45max (0.018max)
HK1005(0402)	0.5 (0.020)	0.65±0.1 (0.026±0.004)	1.15±0.1 (0.045±0.004)	2.0±0.05 (0.079±0.002)	0.8max (0.031max)
HK1608(0603)	0.8 (0.031)	1.0±0.2 (0.039±0.008)	1.8±0.2 (0.071±0.008)	4.0±0.1 (0.157±0.004)	1.1max (0.043max)
HKQ0603S(0201)	0.3 (0.012)	0.40±0.06 (0.016±0.002)	0.70±0.06 (0.028±0.002)	2.0±0.05 (0.079±0.002)	0.45max (0.018max)
HKQ0603U(0201)	0.3 (0.012)	0.40±0.06 (0.016±0.002)	0.70±0.06 (0.028±0.002)	2.0±0.05 (0.079±0.002)	0.45max (0.018max)
AQ105(0402)	0.5 (0.020)	0.75±0.1 (0.030±0.004)	1.15±0.1 (0.045±0.004)	2.0±0.05 (0.079±0.002)	0.8max (0.031max)
BK0603(0201)	0.3 (0.012)	0.40±0.06 (0.016±0.002)	0.70±0.06 (0.028±0.002)	2.0±0.05 (0.079±0.002)	0.45max (0.018max)
BK1005(0402)	0.5 (0.020)	0.65±0.1 (0.026±0.004)	1.15±0.1 (0.045±0.004)	2.0±0.05 (0.079±0.002)	0.8max (0.031max)
BK1608(0603)	0.8 (0.031)	1.0±0.2 (0.039±0.008)	1.8±0.2 (0.071±0.008)	4.0±0.1 (0.157±0.004)	1.1max (0.043max)
BK2125(0805)	0.85(0.033)	1.5±0.2 (0.059±0.008)	2.3±0.2 (0.091±0.008)	4.0±0.1 (0.157±0.004)	1.1max (0.043max)
BK2010(0804)	0.45(0.018)	1.2±0.1 (0.047±0.004)	2.17±0.1 (0.085±0.004)	4.0±0.1 (0.157±0.004)	0.8max (0.031max)
BKP0603(0201)	0.3 (0.012)	0.40±0.06 (0.016±0.002)	0.70±0.06 (0.028±0.002)	2.0±0.05 (0.079±0.002)	0.45max (0.018max)
BKP1005(0402)	0.5 (0.020)	0.65±0.1 (0.026±0.004)	1.15±0.1 (0.045±0.004)	2.0±0.05 (0.079±0.002)	0.8max (0.031max)
BKP1608(0603)	0.8 (0.031)	1.0±0.2 (0.039±0.008)	1.8±0.2 (0.071±0.008)	4.0±0.1 (0.157±0.004)	1.1max (0.043max)
BKP2125(0805)	0.85(0.033)	1.5±0.2 (0.059±0.008)	2.3±0.2 (0.091±0.008)	4.0±0.1 (0.157±0.004)	1.1max (0.043max)
BKH0603(0201)	0.3 (0.012)	0.40±0.06 (0.016±0.002)	0.70±0.06 (0.028±0.002)	2.0±0.05 (0.079±0.002)	0.45max (0.018max)
BKH1005(0402)	0.5 (0.020)	0.65±0.1 (0.026±0.004)	1.15±0.1 (0.045±0.004)	2.0±0.05 (0.079±0.002)	0.8max (0.031max)
MCF0605(0202)	0.3 (0.012)	0.62±0.03 (0.024±0.001)	0.77±0.03 (0.030±0.001)	2.0±0.05 (0.079±0.002)	0.45max (0.018max)
MCFK1608(0603)	0.6 (0.024)	1.1±0.05 (0.043±0.002)	1.9±0.05 (0.075±0.002)	4.0±0.1 (0.157±0.004)	0.72max (0.028max)
MCEE1005(0402)	0.55(0.021)	0.8±0.05 (0.031±0.002)	1.3±0.05 (0.051±0.002)	2.0±0.05 (0.079±0.002)	0.64max (0.025max)
MCEK1210(0504)	0.5 (0.020)	1.3±0.1 (0.051±0.004)	1.55±0.1 (0.061±0.004)	4.0±0.1 (0.157±0.004)	0.64max (0.025max)
MGFK1608(0603)	0.6 (0.024)	1.1±0.05 (0.043±0.002)	1.9±0.05 (0.075±0.002)	4.0±0.1 (0.157±0.004)	0.72max (0.028max)
MCFE1608(0603)	0.65(0.026)	1.1±0.05 (0.043±0.002)	1.9±0.05 (0.075±0.002)	4.0±0.1 (0.157±0.004)	0.72max (0.028max)
MCHK1608(0603)	0.8 (0.031)	1.2±0.05 (0.047±0.002)	2.0±0.05 (0.079±0.002)	4.0±0.1 (0.157±0.004)	0.9max (0.035max)
MCHK2012(0805)	0.8 (0.031)	1.65±0.1 (0.065±0.004)	2.4±0.1 (0.094±0.004)	4.0±0.1 (0.157±0.004)	0.9max (0.035max)

Unit : mm (inch)



### ⑤ Reel Size

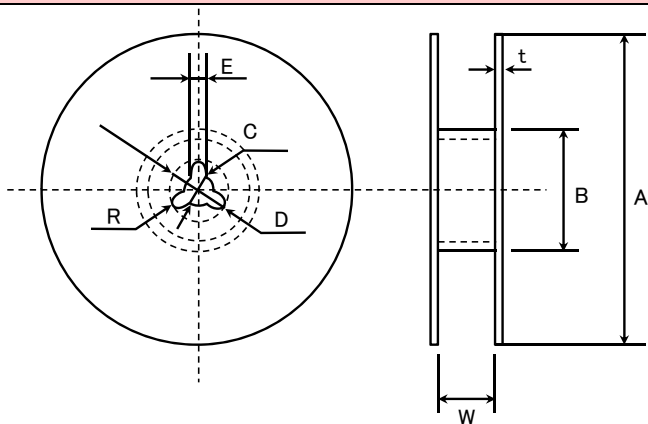

A	B	C	D	E	R
$\phi 178 \pm 2.0$	$\phi 60$ or more	$\phi 13.0 \pm 0.2$	$\phi 21.0 \pm 0.8$	$2.0 \pm 0.5$	1.0

	t	W
4mm width tape	1.5max.	$5 \pm 1.0$
8mm width tape	2.5max.	$10 \pm 1.5$

(Unit : mm)

### ⑥ Top tape strength

The top tape requires a peel-off force of 0.1~0.7N in the direction of the arrow as illustrated below.

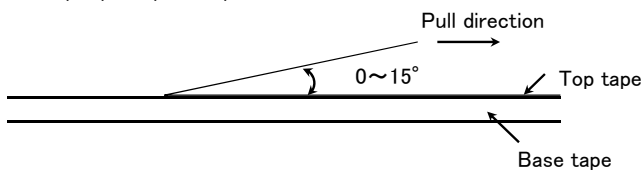



# Multilayer chip inductors

## Multilayer chip inductors for high frequency, Multilayer chip bead inductors

## Multilayer common mode choke coils (MC series F type)

## Metal Multilayer Chip Power Inductors (MCOIL™ MC series)

### RELIABILITY DATA

1. Operating Temperature Range		
Specified Value	BK series	-55 ~ +125°C
	BKH series	
	BKP series	-55 ~ +85°C
	MCF series	-40 ~ +85°C
	CK series	-40 ~ +85°C
	CKS series	
	CKP series	
	LK series	
	HK0603, HK1005	-55 ~ +125°C
	HK1608, HK2125	-40 ~ +85°C
	HKQ0603	-55 ~ +125°C
	AQ105	
MCOIL™ MC series	-40 ~ +125°C (Including self-generated heat)	

2. Storage Temperature Range		
Specified Value	BK series	-55 ~ +125°C
	BKH series	
	BKP series	-55 ~ +85°C
	MCF series	-40 ~ +85°C
	CK series	-40 ~ +85°C
	CKS series	
	CKP series	
	LK series	
	HK0603, HK1005	-55 ~ +125°C
	HK1608, HK2125	-40 ~ +85°C
	HKQ0603	-55 ~ +125°C
	AQ105	
MCOIL™ MC series	-40 ~ +85°C	

3. Rated Current		
Specified Value	BK series	The temperature of the element is increased within 20°C.
	BKH series	
	BKP series	The temperature of the element is increased within 40°C
	MCF series	Refer to each specification.
	CK series	The temperature of the element is increased within 20°C.
	CKS series	
	CKP series	The temperature of the element is increased within 40°C
	LK series	The decreasing-rate of inductance value is within 5 %
	HK0603, HK1005	The decreasing-rate of inductance value is within 5 %, or the temperature of the element is increased within 20°C
	HK1608, HK2125	
	HKQ0603	
	AQ105	
MCOIL™ MC series	Idc1: The decreasing-rate of inductance value is within 30 % Idc2: The temperature of the element is increased within 40°C	

► This catalog contains the typical specification only due to the limitation of space. When you consider the purchase of our products, please check our specification.  
For details of each product (characteristics graph, reliability information, precautions for use, and so on), see our Web site (<http://www.ty-top.com/>).

4. Impedance		
Specified Value	BK series	Refer to each specification.
	BKH series	
	BKP series	
	MCF series	
Test Methods and Remarks	BK0603Series, BKP0603Series, BKH Series	
	Measuring frequency : 100±1MHz	
	Measuring equipment : 4991A (or its equivalent)	
	Measuring jig : 16193A (or its equivalent)	
	BK1005Series, BKP1005Series, BKH1005Series	
	Measuring frequency : 100±1MHz	
	Measuring equipment : 4291A (or its equivalent)	
	Measuring jig : 16192A ( or its equivalent ) , HW:16193A ( or its equivalent)	
	BK1608・2125Series, BKP1608・2125Series	
	Measuring frequency : 100±1MHz	
	Measuring equipment : 4291A (or its equivalent), 4195A (or its equivalent)	
	Measuring jig : 16192A (or its equivalent), HW:16193A (or its equivalent)	
Test Methods and Remarks	BK2010・3216Series	
	Measuring frequency : 100±1MHz	
	Measuring equipment : 4291A (or its equivalent), 4195A (or its equivalent)	
	Measuring jig : 16192A (or its equivalent)	
	MCF Series	
	Measuring frequency : 100±1MHz	
Measuring equipment : 4291A (or its equivalent)		

5. Inductance			
Specified Value	CK series	Refer to each specification.	
	CKS series		
	CKP series		
	LK series		
	HK0603, HK1005		
	HK1608, HK2125		
	HKQ0603		
	AQ105		
Test Methods and Remarks	MCOIL™ MC series		
	CK, CKS, LK Series		
	Measuring frequency : Refer to each specification.		
	Measuring equipment /jig : 1608,2125⇒4294A+16092A (or its equivalent)		
	1005⇒4291A+16193A (or its equivalent)		
	Measuring current : 047~4.7 μH ⇒1mArms , 5.6~33 μH ⇒0.1mArms		
	CKP, MCOIL™ MC Series		
	Measuring frequency : 1MHz		
	Measuring equipment : 4285A (or its equivalent)		
	Test Methods and Remarks	HK0603, HK1005, AQ Series	
		Measuring frequency : 100MHz	
		Measuring equipment /jig : HK0603⇒ E4991A+16197A (or its equivalent) , AQ105⇒4291A+16197A (or its equivalent)	
HK1005⇒ 4291A+16193A (or its equivalent)			
HK1608, HK2125 Series			
Measuring frequency : ~100nH⇒100MHz , 120nH⇒50MHz			
Measuring equipment /jig : 4291A+16092A (or its equivalent)			
Test Methods and Remarks	HKQ Series		
	Measuring frequency : 500MHz		
Measuring equipment /jig : E4991A+16197A (or its equivalent)			

▶ This catalog contains the typical specification only due to the limitation of space. When you consider the purchase of our products, please check our specification. For details of each product (characteristics graph, reliability information, precautions for use, and so on), see our Web site (<http://www.ty-top.com/>).

6. Q		
Specified Value	CK series	—
	CKS series	
	CKP series	
	LK series	Refer to each specification.
	HK0603, HK1005	
	HK1608, HK2125	
	HKQ0603	
	AQ105	
MCOIL™ MC series	—	

Test Methods and Remarks	LK Series	
	Measuring frequency	: Refer to each specification.
	Measuring equipment /jig	: 1608,2125⇒4294A+16092A (or its equivalent) 1005⇒4291A+16193A (or its equivalent)
	Measuring current	: 047~4.7 μH ⇒1mArms、5.6~33 μH ⇒0.1mArms
	HK0603, HK1005, AQ Series	
	Measuring frequency	: 100MHz
	Measuring equipment /jig	: HK0603⇒E4991A+16197A (or its equivalent), AQ105⇒4291A+16197A (or its equivalent) HK1005⇒4291A+16193A (or its equivalent)
	HK1608, HK2125 Series	
	Measuring frequency	: ~100nH⇒100MHz、120nH⇒50MHz
	Measuring equipment /jig	: 4291A+16092A (or its equivalent)
Test Methods and Remarks	HKQ Series	
	Measuring frequency	: 500MHz
	Measuring equipment /jig	: E4991A+16197A (or its equivalent)

### 7. DC Resistance

Specified Value	BK series	Refer to each specification.
	BKH series	
	BKP series	
	MCF series	
	CK series	
	CKS series	
	CKP series	
	LK series	
	HK0603, HK1005	
	HK1608, HK2125	
	HKQ0603	
	AQ105	
	MCOIL™ MC series	
Test Methods and Remarks	Measuring equipment: IWATSU VOAC7512, HIOKI RM3545 (or its equivalent)	

### 8. Self Resonance Frequency (SRF)

Specified Value	BK series	—
	BKH series	
	BKP series	
	MCF series	Refer to each specification.
	CK series	
	CKS series	
	CKP series	—
	LK series	Refer to each specification.
	HK0603, HK1005	
	HK1608, HK2125	
	HKQ0603	
	AQ105	
	MCOIL™ MC series	—
Test Methods and Remarks	LK, CK Series : Measuring equipment : 4195A (or its equivalent) Measuring jig : 16092A (or its equivalent) HK, HKQ, AQ Series : Measuring equipment : 8719C (or its equivalent)	

▶ This catalog contains the typical specification only due to the limitation of space. When you consider the purchase of our products, please check our specification.  
For details of each product (characteristics graph, reliability information, precautions for use, and so on), see our Web site (<http://www.ty-top.com/>).

9. Resistance to Flexure of Substrate

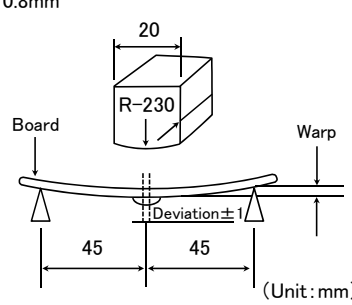
Specified Value	BK series	No mechanical damage.
	BKH series	
	BKP series	
	MCF series	
	CK series	
	CKS series	
	CKP series	
	LK series	
	HK0603, HK1005	
	HK1608, HK2125	
	HKQ0603	
	AQ105	
MCOIL™ MC series		
Test Methods and Remarks	Warp : 2mm (BK Series, BKP, BKH1005, CK, CKS, CKP, LK, HK, HKQ0603S, HKQ0603U, AQ Series, MCF1210, MC Series) : 1mm (BKH0603, MCF Series without 1210 size.) Testing board : glass epoxy-resin substrate Thickness : 0.8mm	

10. Solderability

Specified Value	BK series	At least 90% of terminal electrode is covered by new solder.
	BKH series	
	BKP series	
	MCF series	
	CK series	
	CKS series	
	CKP series	
	LK series	
	HK0603, HK1005	
	HK1608, HK2125	
	HKQ0603	
	AQ105	
MCOIL™ MC series		
Test Methods and Remarks	Solder temperature : 230±5°C (JIS Z 3282 H60A or H63A)	
	Solder temperature : 245±3°C (Sn/3.0Ag/0.5Cu)	
	Duration : 4±1 sec.	

► This catalog contains the typical specification only due to the limitation of space. When you consider the purchase of our products, please check our specification. For details of each product (characteristics graph, reliability information, precautions for use, and so on), see our Web site (<http://www.ty-top.com/>).

## 11. Resistance to Soldering

Specified Value	BK series	Appearance: No significant abnormality Impedance change: Within $\pm 30\%$
	BKH series	
	BKP series	
	MCF series	Appearance: No significant abnormality Impedance change: Within $\pm 20\%$
	CK series	Appearance: No significant abnormality Inductance change: R10~4R7 $\Rightarrow$ Within $\pm 10\%$ 、6R8~100 $\Rightarrow$ Within $\pm 15\%$
	CKS series	Appearance: No significant abnormality Inductance change: Within $\pm 20\%$
	CKP series	Appearance: No significant abnormality Inductance change: Within $\pm 30\%$
	LK series	Appearance: No significant abnormality Inductance change: 1005 $\Rightarrow$ Within $\pm 15\%$ 1608,2125 $\Rightarrow$ 47N~4R7: Within $\pm 10\%$ 5R6~330: Within $\pm 15\%$
	HK0603, HK1005	Appearance: No significant abnormality Inductance change: Within $\pm 5\%$
	HK1608, HK2125	
	HKQ0603	
	AQ105	
MCOIL™ MC series	Appearance: No significant abnormality Inductance change: Within $\pm 10\%$	
Test Methods and Remarks	Solder temperature : $260 \pm 5^\circ\text{C}$ Duration : $10 \pm 0.5$ sec. Preheating temperature : $150$ to $180^\circ\text{C}$ Preheating time : 3 min. Flux : Immersion into methanol solution with colophony for 3 to 5 sec. Recovery : 2 to 3 hrs of recovery under the standard condition after the test. (See Note 1)	

(Note 1) When there are questions concerning measurement result; measurement shall be made after  $48 \pm 2$  hrs of recovery under the standard condition.

## 12. Thermal Shock

Specified Value	BK series	Appearance: No significant abnormality Impedance change: Within $\pm 30\%$															
	BKH series																
	BKP series																
	MCF series	Appearance: No significant abnormality Impedance change: Within $\pm 20\%$															
	CK series	Appearance: No significant abnormality Inductance change: Within $\pm 20\%$															
	CKS series	Appearance: No significant abnormality Inductance change: Within $\pm 20\%$															
	CKP series	Appearance: No significant abnormality Inductance change: Within $\pm 30\%$															
	LK series	Appearance: No significant abnormality Inductance change: Within $\pm 10\%$ Q change: Within $\pm 30\%$															
	HK0603, HK1005	Appearance: No significant abnormality Inductance change: Within $\pm 10\%$ Q change: Within $\pm 20\%$															
	HK1608, HK2125																
	HKQ0603																
	AQ105																
MCOIL™ MC series	Appearance: No significant abnormality Inductance change: Within $\pm 10\%$																
Test Methods and Remarks	Conditions for 1 cycle <table border="1" style="margin-left: 20px;"> <thead> <tr> <th>Step</th> <th>temperature (<math>^\circ\text{C}</math>)</th> <th>time (min.)</th> </tr> </thead> <tbody> <tr> <td>1</td> <td>Minimum operating temperature <math>+0/-3</math></td> <td><math>30 \pm 3</math></td> </tr> <tr> <td>2</td> <td>Room temperature</td> <td>2~3</td> </tr> <tr> <td>3</td> <td>Maximum operating temperature <math>+3/-0</math></td> <td><math>30 \pm 3</math></td> </tr> <tr> <td>4</td> <td>Room temperature</td> <td>2~3</td> </tr> </tbody> </table> Number of cycles: 5 Recovery: 2 to 3 hrs of recovery under the standard condition after the test. (See Note 1)		Step	temperature ( $^\circ\text{C}$ )	time (min.)	1	Minimum operating temperature $+0/-3$	$30 \pm 3$	2	Room temperature	2~3	3	Maximum operating temperature $+3/-0$	$30 \pm 3$	4	Room temperature	2~3
Step	temperature ( $^\circ\text{C}$ )	time (min.)															
1	Minimum operating temperature $+0/-3$	$30 \pm 3$															
2	Room temperature	2~3															
3	Maximum operating temperature $+3/-0$	$30 \pm 3$															
4	Room temperature	2~3															

(Note 1) When there are questions concerning measurement result; measurement shall be made after  $48 \pm 2$  hrs of recovery under the standard condition.

13. Damp Heat ( Steady state)		
Specified Value	BK series	Appearance: No significant abnormality Impedance change: Within $\pm 30\%$
	BKH series	
	BKP series	
	MCF series	Appearance: No significant abnormality Impedance change: Within $\pm 20\%$
	CK series	Appearance: No significant abnormality Inductance change: Within $\pm 20\%$
	CKS series	
	CKP series	Appearance: No significant abnormality Inductance change: Within $\pm 30\%$
	LK series	Appearance: No significant abnormality Inductance change: 1005,1608 $\Rightarrow$ Within $\pm 10\%$ 2125 $\Rightarrow$ Within $\pm 20\%$ Q change: Within $\pm 30\%$
	HK0603, HK1005	Appearance: No significant abnormality Inductance change: Within $\pm 10\%$ Q change: Within $\pm 20\%$
	HK1608, HK2125	
	HKQ0603	
	AQ105	
	MCOIL™ MC series	Appearance: No significant abnormality Inductance change: Within $\pm 10\%$
Test Methods and Remarks	BK, BKP, BKH, LK, CK, CKS, CKP, MCF Series: Temperature : $40 \pm 2^\circ\text{C}$ Humidity : 90 to 95%RH Duration : 500 +24/-0 hrs Recovery : 2 to 3 hrs of recovery under the standard condition after the removal from test chamber. (See Note 1)	
	HK, HKQ, AQ, MCOIL™ MC series: Temperature : $60 \pm 2^\circ\text{C}$ Humidity : 90 to 95%RH Duration : 500 +24/-0 hrs Recovery : 2 to 3 hrs of recovery under the standard condition after the removal from test chamber. (See Note 1)	

(Note 1) When there are questions concerning measurement result; measurement shall be made after  $48 \pm 2$  hrs of recovery under the standard condition.

14. Loading under Damp Heat

Specified Value	BK series	Appearance: No significant abnormality Impedance change: Within $\pm 30\%$
	BKH series	
	BKP series	
	MCF series	—
	CK series	Appearance: No significant abnormality
	CKS series	Inductance change: Within $\pm 20\%$
	CKP series	Appearance: No significant abnormality Inductance change: Within $\pm 30\%$
	LK series	Appearance: No significant abnormality Inductance change: 1005 $\Rightarrow$ Within $\pm 10\%$ 1608 $\Rightarrow$ 0.047 ~ 12.0 $\mu\text{H}$ : Within $\pm 10\%$ 15.0 ~ 33.0 $\mu\text{H}$ : Within $\pm 15\%$ 2125 $\Rightarrow$ Within $\pm 20\%$ Q change: Within $\pm 30\%$
	HK0603, HK1005	Appearance: No significant abnormality Inductance change: Within $\pm 10\%$ Q change: Within $\pm 20\%$
	HK1608, HK2125	
	HKQ0603	
	AQ105	
MCOIL™ MC series※	Appearance: No significant abnormality Inductance change: Within $\pm 10\%$	

Test Methods and Remarks	BK, BKP, BKH, LK, CK, CKS, CKP Series:	Temperature : $40 \pm 2^\circ\text{C}$ Humidity : 90 to 95%RH Applied current : Rated current Duration : 500 +24/-0 hrs Recovery : 2 to 3 hrs of recovery under the standard condition after the removal from test chamber. (See Note 1)
	HK, HKQ, AQ, MCOIL™ MC Series:	Temperature : $60 \pm 2^\circ\text{C}$ Humidity : 90 to 95%RH Applied current : Rated current ※MC series ; $I_{dc2max}$ Duration : 500 +24/-0 hrs Recovery : 2 to 3 hrs of recovery under the standard condition after the removal from test chamber. (See Note 1)

Note on standard condition: "standard condition" referred to herein is defined as follows:

5 to 35°C of temperature, 45 to 85% relative humidity, and 86 to 106kPa of air pressure.

When there are questions concerning measurement results:

In order to provide correlation data, the test shall be conducted under condition of  $20 \pm 2^\circ\text{C}$  of temperature, 60 to 70% relative humidity, and 86 to 106kPa of air pressure.

Unless otherwise specified, all the tests are conducted under the "standard condition."

(Note 1) Measurement shall be made after  $48 \pm 2$  hrs of recovery under the standard condition.

15. Loading at High Temperature		
Specified Value	BK series	Appearance: No significant abnormality Impedance change: Within $\pm 30\%$
	BKH series	
	BKP series	
	MCF series	Appearance: No significant abnormality Impedance change: Within $\pm 20\%$
	CK series	Appearance: No significant abnormality Inductance change: Within $\pm 20\%$
	CKS series	
	CKP series	Appearance: No significant abnormality Inductance change: Within $\pm 30\%$
	LK series	Appearance: No significant abnormality Inductance change: 1005 $\Rightarrow$ Within $\pm 10\%$ 1608 $\Rightarrow$ 0.047 ~ 12.0 $\mu\text{H}$ : Within $\pm 10\%$ 15.0 ~ 33.0 $\mu\text{H}$ : Within $\pm 15\%$ 2125 $\Rightarrow$ Within $\pm 20\%$ Q change: Within $\pm 30\%$
	HK0603, HK1005	Appearance: No significant abnormality Inductance change: Within $\pm 10\%$ Q change: Within $\pm 20\%$
	HK1608, HK2125	
	HKQ0603	
	AQ105	
	MCOIL™ MC series※	Appearance: No significant abnormality Inductance change: Within $\pm 10\%$
Test Methods and Remarks	Temperature : Maximum operating temperature Applied current : Rated current ※MC series ; $I_{dc2max}$ Duration : 500 +24/-0 hrs Recovery : 2 to 3 hrs of recovery under the standard condition after the removal from test chamber. (See Note 1)	

Note on standard condition: "standard condition" referred to herein is defined as follows:

5 to 35°C of temperature, 45 to 85% relative humidity, and 86 to 106kPa of air pressure.

When there are questions concerning measurement results:

In order to provide correlation data, the test shall be conducted under condition of  $20 \pm 2^\circ\text{C}$  of temperature, 60 to 70% relative humidity, and 86 to 106kPa of air pressure. Unless otherwise specified, all the tests are conducted under the "standard condition."

(Note 1) Measurement shall be made after  $48 \pm 2$  hrs of recovery under the standard condition.



# Precautions on the use of Multilayer chip inductors

## Multilayer chip inductors for high frequency, Multilayer chip bead inductors

### Multilayer common mode choke coils (MC series F type)

#### PRECAUTIONS

#### 1. Circuit Design

- Precautions**
- ◆ Verification of operating environment, electrical rating and performance
    1. A malfunction in medical equipment, spacecraft, nuclear reactors, etc. may cause serious harm to human life or have severe social ramifications.  
As such, any inductors to be used in such equipment may require higher safety and/or reliability considerations and should be clearly differentiated from components used in general purpose applications.
  - ◆ Operating Current (Verification of Rated current)
    1. The operating current including inrush current for inductors must always be lower than their rated values.
    2. Do not apply current in excess of the rated value because the inductance may be reduced due to the magnetic saturation effect.

#### 2. PCB Design

- Precautions**
- ◆ Pattern configurations (Design of Land-patterns)
    1. When inductors are mounted on a PCB, the size of land patterns and the amount of solder used (size of fillet) can directly affect inductor performance.  
Therefore, the following items must be carefully considered in the design of solder land patterns:
      - (1) The amount of solder applied can affect the ability of chips to withstand mechanical stresses which may lead to breaking or cracking. Therefore, when designing land-patterns it is necessary to consider the appropriate size and configuration of the solder pads which in turn determines the amount of solder necessary to form the fillets.
      - (2) When more than one part is jointly soldered onto the same land or pad, the pad must be designed so that each component's soldering point is separated by solder-resist.
      - (3) The larger size of land patterns and amount of solder, the smaller Q value after mounting on PCB. It makes higher the Q value to design land patterns smaller than terminal electrode of chips.
  - ◆ Pattern configurations (Inductor layout on panelized [breakaway] PC boards)
    1. After inductors have been mounted on the boards, chips can be subjected to mechanical stresses in subsequent manufacturing processes (PCB cutting, board inspection, mounting of additional parts, assembly into the chassis, wave soldering the reflow soldered boards etc.) For this reason, planning pattern configurations and the position of SMD inductors should be carefully performed to minimize stress.

- ◆ Pattern configurations (Design of Land-patterns)
  1. The following diagrams and tables show some examples of recommended patterns to prevent excessive solder amounts (larger fillets which extend above the component end terminations). Examples of improper pattern designs are also shown.
    - (1) Recommended land dimensions for a typical chip inductor land patterns for PCBs

● Recommended land dimensions for Multilayer inductor  
Wave-soldering (Unit: mm)

Type	1608	2012	2125	2016	2520	3216
Size	L	1.6	2.0	2.0	2.0	3.2
	W	0.8	1.25	1.25	1.6	1.6
A	0.8~1.0	1.0~1.4	1.0~1.4	1.0~1.4	1.0~1.4	1.8~2.5
B	0.5~0.8	0.8~1.5	0.8~1.5	0.8~1.5	0.6~1.0	0.8~1.7
C	0.6~0.8	0.9~1.2	0.9~1.2	1.3~1.6	1.6~2.0	1.2~1.6

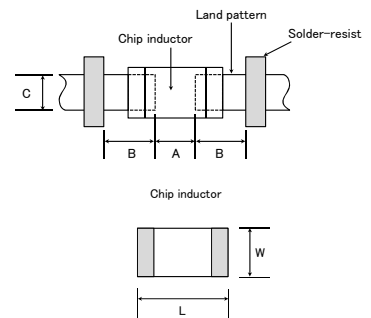

Reflow-soldering (Unit: mm)

Type	0603	1005	105	1608	2012	2125	2016	2520	3216
Size	L	0.6	1.0	1.0	1.6	2.0	2.0	2.0	3.2
	W	0.3	0.5	0.6	0.8	1.25	1.25	1.6	1.6
A	0.20~0.30	0.45~0.55	0.50~0.55	0.8~1.0	0.8~1.2	0.8~1.2	0.8~1.2	1.0~1.4	1.8~2.5
B	0.20~0.30	0.40~0.50	0.30~0.40	0.6~0.8	0.8~1.2	0.8~1.2	0.8~1.2	0.6~1.0	0.6~1.5
C	0.25~0.40	0.45~0.55	0.60~0.70	0.6~0.8	0.9~1.6	0.9~1.6	1.2~2.0	1.8~2.2	1.2~2.0

● Recommended land dimension for Array type  
(Unit: mm)

Type	2010	3216
Size	L	2.0
	W	1.0
a	0.5~0.6	0.7~0.9
b	0.5~0.6	0.8~1.0
c	0.2~0.3	0.4~0.5
d	0.5	0.8

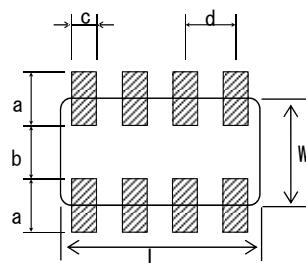

Technical considerations

▶ This catalog contains the typical specification only due to the limitation of space. When you consider the purchase of our products, please check our specification. For details of each product (characteristics graph, reliability information, precautions for use, and so on), see our Web site (<http://www.ty-top.com/>).

● Recommended land dimension for Multilayer common mode choke coil  
(Unit: mm)

Type	0605	0806	
Size	L	0.65	0.85
	W	0.50	0.65
a	0.27~0.30	0.25~0.35	
b	0.17~0.20	0.25~0.35	
c	0.20~0.26	0.25~0.35	
d	0.4	0.5	

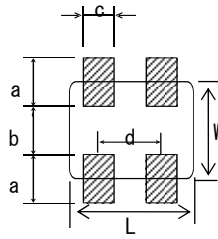

(Unit: mm)

Type	1210	
Size	L	1.0
	W	1.25
a	0.45~0.55	
b	0.7~0.8	
c	0.25~0.35	
d	0.55	

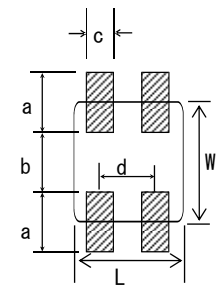

(2) Examples of good and bad solder application

Item	Not recommended	Recommended
Mixed mounting of SMD and leaded components	Lead wire of component	Solder-resist
Component placement close to the chassis	Chassis Solder (for grounding) Electrode pattern	Solder-resist
Hand-soldering of leaded components near mounted components	Lead wire of component Soldering iron	Solder-resist
Horizontal component placement	Solder-resist	Solder-resist

◆ Pattern configurations (Inductor layout on panelized [breakaway] PC boards)

1-1. The following are examples of good and bad inductor layout; SMD inductors should be located to minimize any possible mechanical stresses from board warp or deflection.

Item	Not recommended	Recommended
Deflection of the board		Position the component at a right angle to the direction of the mechanical stresses that are anticipated.

1-2. To layout the inductors for the breakaway PC board, it should be noted that the amount of mechanical stresses given will vary depending on inductor layout.

An example below should be counted for better design.

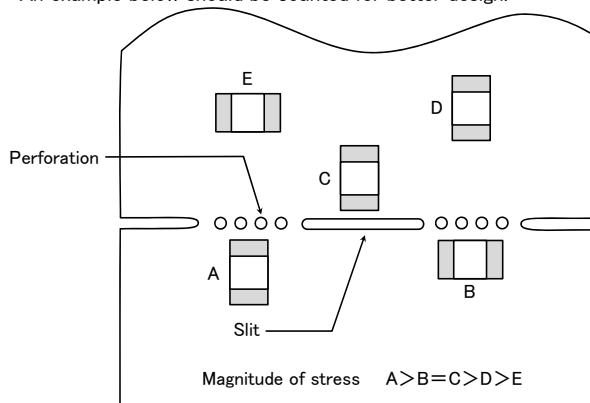

1-3. When breaking PC boards along their perforations, the amount of mechanical stress on the inductors can vary according to the method used. The following methods are listed in order from least stressful to most stressful: push-back, slit, V-grooving, and perforation. Thus, any ideal SMD inductor layout must also consider the PCB splitting procedure.

Precautions

- ◆ Adjustment of mounting machine
  1. Excessive impact load should not be imposed on the inductors when mounting onto the PC boards.
  2. The maintenance and inspection of the mounter should be conducted periodically.
- ◆ Selection of Adhesives
  1. Mounting inductors with adhesives in preliminary assembly, before the soldering stage, may lead to degraded inductor characteristics unless the following factors are appropriately checked; the size of land patterns, type of adhesive, amount applied, hardening temperature and hardening period. Therefore, it is imperative to consult the manufacturer of the adhesives on proper usage and amounts of adhesive to use.

Technical considerations

- ◆ Adjustment of mounting machine
  1. If the lower limit of the pick-up nozzle is low, too much force may be imposed on the inductors, causing damage. To avoid this, the following points should be considered before lowering the pick-up nozzle:
    - (1) The lower limit of the pick-up nozzle should be adjusted to the surface level of the PC board after correcting for deflection of the board.
    - (2) The pick-up pressure should be adjusted between 1 and 3N static loads.
    - (3) To reduce the amount of deflection of the board caused by impact of the pick-up nozzle, supporting pins or back-up pins should be used under the PC board. The following diagrams show some typical examples of good pick-up nozzle placement:

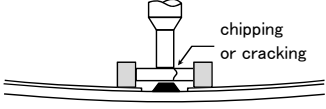
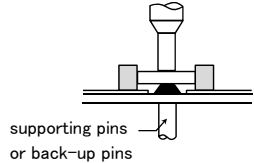
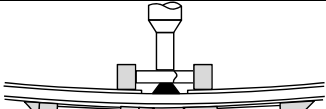
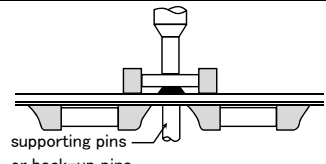
Item	Improper method	Proper method
Single-sided mounting		
Double-sided mounting		

2. As the alignment pin wears out, adjustment of the nozzle height can cause chipping or cracking of the inductors because of mechanical impact on the inductors. To avoid this, the monitoring of the width between the alignment pin in the stopped position, and maintenance, inspection and replacement of the pin should be conducted periodically.
- ◆ Selection of Adhesives
    1. Some adhesives may cause reduced insulation resistance. The difference between the shrinkage percentage of the adhesive and that of the inductors may result in stresses on the inductors and lead to cracking. Moreover, too little or too much adhesive applied to the board may adversely affect component placement, so the following precautions should be noted in the application of adhesives.
      - (1) Required adhesive characteristics
        - a. The adhesive should be strong enough to hold parts on the board during the mounting & solder process.
        - b. The adhesive should have sufficient strength at high temperatures.
        - c. The adhesive should have good coating and thickness consistency.
        - d. The adhesive should be used during its prescribed shelf life.
        - e. The adhesive should harden rapidly.
        - f. The adhesive must not be contaminated.
        - g. The adhesive should have excellent insulation characteristics.
        - h. The adhesive should not be toxic and have no emission of toxic gasses.
      - (2) When using adhesives to mount inductors on a PCB, inappropriate amounts of adhesive on the board may adversely affect component placement. Too little adhesive may cause the inductors to fall off the board during the solder process. Too much adhesive may cause defective soldering due excessive flow of adhesive on to the land or solder pad.

[Recommended conditions]

Figure	0805 case sizes as examples
a	0.3mm min
b	100~120 μm
c	Area with no adhesive

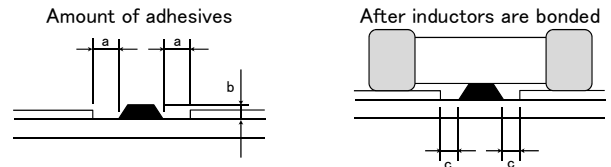

Precautions

- ◆ Selection of Flux
  1. Since flux may have a significant effect on the performance of inductors, it is necessary to verify the following conditions prior to use;
    - (1) Flux used should be with less than or equal to 0.1 wt% (Chlorine conversion method) of halogenated content. Flux having a strong acidity content should not be applied.
    - (2) When soldering inductors on the board, the amount of flux applied should be controlled at the optimum level.
    - (3) When using water-soluble flux, special care should be taken to properly clean the boards.
- ◆ Soldering
  1. Temperature, time, amount of solder, etc. are specified in accordance with the following recommended conditions, and please contact us about peak temperature when you use lead-free paste.

Technical considerations

- ◆ Selection of Flux
  - 1-1. When too much halogenated substance (Chlorine, etc.) content is used to activate the flux, or highly acidic flux is used, an excessive amount of residue after soldering may lead to corrosion of the terminal electrodes or degradation of insulation resistance on the surface of the inductor.
  - 1-2. Flux is used to increase solderability in flow soldering, but if too much is applied, a large amount of flux gas may be emitted and may detrimentally affect solderability. To minimize the amount of flux applied, it is recommended to use a flux-bubbling system.
  - 1-3. Since the residue of water-soluble flux is easily dissolved by water content in the air, the residue on the surface of inductor in high humidity conditions may cause a degradation of insulation resistance and therefore affect the reliability of the components. The cleaning methods and the capability of the machines used should also be considered carefully when selecting water-soluble flux.
- ◆ Soldering
  - 1-1. Preheating when soldering
 

Preheating: Inductors shall be preheated sufficiently, and the temperature difference between the inductors and solder shall be within 130° C.

Cooling: The temperature difference between the components and cleaning process should not be greater than 100°C.

Inductors are susceptible to thermal shock when exposed to rapid or concentrated heating or rapid cooling. Therefore, the soldering process must be conducted with a great care so as to prevent malfunction of the components due to excessive thermal shock.

[Reflow soldering]  
 【Recommended condition for Pb-free soldering】

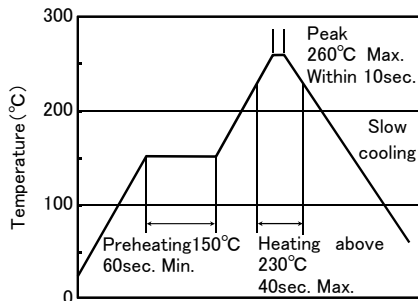

Caution

1. Solder (fillet) should wet up to 1/2 to 1/3 of the thickness of an inductor ideally as shown below:

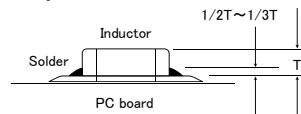

2. Because excessive dwell time can detrimentally affect solderability, soldering duration shall be kept as close to recommended time as possible.
3. The allowable number of reflow soldering is two (2) times.

[Wave soldering]  
 【Recommended condition for Pb-free soldering】

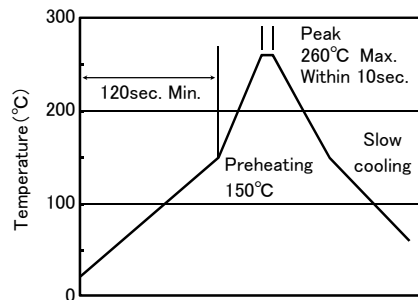

Caution

1. Make sure the inductors are preheated sufficiently.
2. The temperature difference between the inductor and melted solder should be within 130°C.
3. Cooling after soldering should be as gradual as possible.
4. The allowable number of wave soldering is one (1) time.
5. Wave soldering must not be applied to the inductors designated as for reflow soldering only.

[Hand soldering]  
 【Recommended condition for Pb-free soldering】

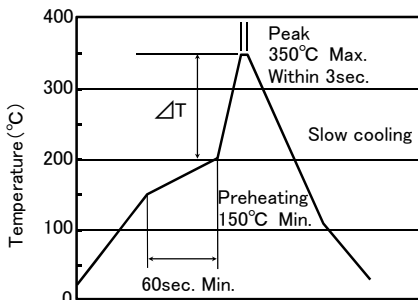

Caution

1. It is recommended to use a 20W soldering iron with a maximum tip diameter of 1.0 mm.
2. The soldering iron shall not directly touch inductors
3. The allowable number of hand soldering is one (1) time

▶ This catalog contains the typical specification only due to the limitation of space. When you consider the purchase of our products, please check our specification. For details of each product (characteristics graph, reliability information, precautions for use, and so on), see our Web site (<http://www.ty-top.com/>).

5. Cleaning							
Precautions	<p>◆Cleaning conditions</p> <ol style="list-style-type: none"> <li>When cleaning the PC board after the Inductors are all mounted, select the appropriate cleaning solution according to the type of flux used and purpose of the cleaning (e.g. to remove soldering flux or other materials from the production process.)</li> <li>Cleaning conditions should be determined after verifying, through a test run, that the cleaning process does not affect the inductor's characteristics.</li> </ol>						
Technical considerations	<p>◆Cleaning conditions</p> <ol style="list-style-type: none"> <li>The use of inappropriate solutions can cause foreign substances such as flux residue to adhere to the inductor, resulting in a degradation of the inductor's electrical properties (especially insulation resistance).</li> <li>Inappropriate cleaning conditions (insufficient or excessive cleaning) may detrimentally affect the performance of the inductors. In the case of ultrasonic cleaning, too much power output can cause excessive vibration of the PC board which may lead to the cracking of the inductor or the soldered portion, or decrease the terminal electrodes' strength. Therefore, the following conditions should be carefully checked;</li> </ol> <table border="0"> <tr> <td>Ultrasonic output</td> <td>20W/ℓ or less</td> </tr> <tr> <td>Ultrasonic frequency</td> <td>40kHz or less</td> </tr> <tr> <td>Ultrasonic washing period</td> <td>5 min. or less</td> </tr> </table>	Ultrasonic output	20W/ℓ or less	Ultrasonic frequency	40kHz or less	Ultrasonic washing period	5 min. or less
Ultrasonic output	20W/ℓ or less						
Ultrasonic frequency	40kHz or less						
Ultrasonic washing period	5 min. or less						

6. Resin coating and mold	
Precautions	<ol style="list-style-type: none"> <li>With some type of resins a decomposition gas or chemical reaction vapor may remain inside the resin during the hardening period or while left under normal storage conditions resulting in the deterioration of the inductor's performance.</li> <li>Thermal expansion and thermal shrinkage characteristics of resins may lead to the deterioration of inductors' performance.</li> <li>When a resin hardening temperature is higher than inductor operating temperature, the stresses generated by the excessive heat may lead to damage in inductors.</li> </ol>

7. Handling	
Precautions	<p>◆Breakaway PC boards (splitting along perforations)</p> <ol style="list-style-type: none"> <li>When splitting the PC board after mounting inductors and other components, care is required so as not to give any stresses of deflection or twisting to the board.</li> <li>Board separation should not be done manually, but by using the appropriate devices.</li> </ol> <p>◆General handling precautions</p> <ul style="list-style-type: none"> <li>Always wear static control bands to protect against ESD.</li> <li>Keep the inductors away from all magnets and magnetic objects.</li> <li>Use non-magnetic tweezers when handling inductors.</li> <li>Any devices used with the inductors ( soldering irons, measuring instruments) should be properly grounded.</li> <li>Keep bare hands and metal products (i.e., metal desk) away from inductor electrodes or conductive areas that lead to chip electrodes.</li> <li>Keep inductors away from items that generate magnetic fields such as speakers or coils.</li> </ul> <p>◆Mechanical considerations</p> <p>Be careful not to subject the inductors to excessive mechanical shocks.</p> <ol style="list-style-type: none"> <li>If inductors are dropped on the floor or a hard surface they should not be used.</li> <li>When handling the mounted boards, be careful that the mounted components do not come in contact with or bump against other boards or components.</li> </ol>

8. Storage conditions	
Precautions	<p>◆Storage</p> <p>To maintain the solderability of terminal electrodes and to keep the packaging material in good condition, care must be taken to control temperature and humidity in the storage area. Humidity should especially be kept as low as possible.</p> <ul style="list-style-type: none"> <li>Recommended conditions Ambient temperature: 30°C or below    Humidity: 70% RH or below</li> </ul> <p>The ambient temperature must be kept below 40°C. Even under ideal storage conditions, solderability of inductor is deteriorated as time passes, so inductors should be used within 6 months from the time of delivery.</p> <ul style="list-style-type: none"> <li>Inductor should be kept where no chlorine or sulfur exists in the air.</li> </ul>
Technical considerations	<p>◆Storage</p> <p>If the parts are stocked in a high temperature and humidity environment, problems such as reduced solderability caused by oxidation of terminal electrodes and deterioration of taping/packaging materials may take place. For this reason, components should be used within 6 months from the time of delivery. If exceeding the above period, please check solderability before using the inductors.</p>

▶ This catalog contains the typical specification only due to the limitation of space. When you consider the purchase of our products, please check our specification. For details of each product (characteristics graph, reliability information, precautions for use, and so on), see our Web site (<http://www.ty-top.com/>).

## X-ON Electronics

Largest Supplier of Electrical and Electronic Components

*Click to view similar products for [Fixed Inductors](#) category:*

*Click to view products by [Taiyo Yuden](#) manufacturer:*

Other Similar products are found below :

[CR43NP-680KC](#) [CR54NP-820KC](#) [CR54NP-8R5MC](#) [CTX32CT-100](#) [70F224AI](#) [MGDQ4-00004-P](#) [MHL1ECTTP18NJ](#) [MHL1JCTTD12NJ](#)  
[PE-51506NL](#) [PE-53601NL](#) [PE-53602NL](#) [PE-53630NL](#) [PE-53824SNLT](#) [PE-62892NL](#) [PE-92100NL](#) [PG0434.801NLT](#) [PG0936.113NLT](#)  
[9310-16](#) [PM06-2N7](#) [PM06-39NJ](#) [A01TK](#) [1206CS-471XJ](#) [HC2-2R2TR](#) [HC2LP-R47-R](#) [HC3-2R2-R](#) [1206CS-151XG](#) [RCH664NP-140L](#)  
[RCH664NP-4R7M](#) [RCH8011NP-221L](#) [RCP1317NP-332L](#) [RCP1317NP-391L](#) [RCR1010NP-470M](#) [RCR110DNP-331L](#) [DH2280-4R7M](#)  
[DS1608C-106](#) [ASPI-4020HI-R10M-T](#) [B10TJ](#) [B82477P4333M](#) [B82498B3101J000](#) [B82498B3680J000](#) [ELJ-RE27NJF2](#) [1812CS-153XJ](#)  
[1812CS-183XJ](#) [1812CS-223XJ](#) [1812LS-104XJ](#) [1812LS-105XJ](#) [1812LS-124XJ](#) [1812LS-154XJ](#) [1812LS-223XJ](#) [1812LS-224XJ](#)