

Please read this notice before using the TAIYO YUDEN products.

REMINDERS

- Product information in this catalog is as of October 2017. All of the contents specified herein are subject to change without notice due to technical improvements, etc. Therefore, please check for the latest information carefully before practical application or use of our products.

Please note that TAIYO YUDEN shall not be in any way responsible for any damages and defects in products or equipment incorporating our products, which are caused under the conditions other than those specified in this catalog or individual product specification sheets.

- Please contact TAIYO YUDEN for further details of product specifications as the individual product specification sheets are available.
- Please conduct validation and verification of our products in actual condition of mounting and operating environment before using our products.
- The products listed in this catalog are intended for use in general electronic equipment (e.g., AV equipment, OA equipment, home electric appliances, office equipment, information and communication equipment including, without limitation, mobile phone, and PC) and medical equipment classified as Class I or II by IMDRF. Please be sure to contact TAIYO YUDEN for further information before using the products for any equipment which may directly cause loss of human life or bodily injury (e.g., transportation equipment including, without limitation, automotive powertrain control system, train control system, and ship control system, traffic signal equipment, disaster prevention equipment, medical equipment classified as Class III by IMDRF, highly public information network equipment including, without limitation, telephone exchange, and base station).

Please do not incorporate our products into any equipment requiring high levels of safety and/or reliability (e.g., aerospace equipment, aviation equipment*, medical equipment classified as Class IV by IMDRF, nuclear control equipment, undersea equipment, military equipment).

*Note: There is a possibility that our products can be used only for aviation equipment that does not directly affect the safe operation of aircraft (e.g., in-flight entertainment, cabin light, electric seat, cooking equipment) if such use meets requirements specified separately by TAIYO YUDEN. Please be sure to contact TAIYO YUDEN for further information before using our products for such aviation equipment.

When our products are used even for high safety and/or reliability-required devices or circuits of general electronic equipment, it is strongly recommended to perform a thorough safety evaluation prior to use of our products and to install a protection circuit as necessary.

Please note that unless you obtain prior written consent of TAIYO YUDEN, TAIYO YUDEN shall not be in any way responsible for any damages incurred by you or third parties arising from use of the products listed in this catalog for any equipment requiring inquiry to TAIYO YUDEN or prohibited for use by TAIYO YUDEN as described above.

- Information contained in this catalog is intended to convey examples of typical performances and/or applications of our products and is not intended to make any warranty with respect to the intellectual property rights or any other related rights of TAIYO YUDEN or any third parties nor grant any license under such rights.
- Please note that the scope of warranty for our products is limited to the delivered our products themselves and TAIYO YUDEN shall not be in any way responsible for any damages resulting from a fault or defect in our products. Notwithstanding the foregoing, if there is a written agreement (e.g., supply and purchase agreement, quality assurance agreement) signed by TAIYO YUDEN and your company, TAIYO YUDEN will warrant our products in accordance with such agreement.
- The contents of this catalog are applicable to our products which are purchased from our sales offices or authorized distributors (hereinafter "TAIYO YUDEN's official sales channel"). Please note that the contents of this catalog are not applicable to our products purchased from any seller other than TAIYO YUDEN's official sales channel.
- Caution for Export
Some of our products listed in this catalog may require specific procedures for export according to "U.S. Export Administration Regulations", "Foreign Exchange and Foreign Trade Control Law" of Japan, and other applicable regulations. Should you have any questions on this matter, please contact our sales staff.

MULTILAYER CERAMIC CAPACITORS



WAVE

REFLOW

PARTS NUMBER

J	M	K	3	1	6	△	B	J	1	0	6	M	L	-	T	△
①	②	③	④	⑤	⑥	⑦	⑧	⑨	⑩	⑪	⑫					

△=Blank space

① Rated voltage

Code	Rated voltage [VDC]
P	2.5
A	4
J	6.3
L	10
E	16
T	25
G	35
U	50
H	100
Q	250
S	630

③ End termination

Code	End termination
K	Plated
S	Cu Internal Electrodes

② Series name

Code	Series name
M	Multilayer ceramic capacitor
V	Multilayer ceramic capacitor for high frequency
W	LW reverse type multilayer capacitor

④ Dimension (L × W)

Type	Dimensions (L × W) [mm]	EIA (inch)
021	0.25 × 0.125	008004
042	0.4 × 0.2	01005
063	0.6 × 0.3	0201
105	1.0 × 0.5	0402
	0.52 × 1.0 ※	0204
107	1.6 × 0.8	0603
	0.8 × 1.6 ※	0306
212	2.0 × 1.25	0805
	1.25 × 2.0 ※	0508
316	3.2 × 1.6	1206
325	3.2 × 2.5	1210
432	4.5 × 3.2	1812

Note : ※LW reverse type (□WK) only

⑤ Dimension tolerance

Code	Type	L [mm]	W [mm]	T [mm]
△	ALL	Standard	Standard	Standard
A	063	0.6±0.05	0.3±0.05	0.3±0.05
	105	1.0±0.10	0.5±0.10	0.5±0.10
	107	1.6+0.15/-0.05	0.8+0.15/-0.05	0.8+0.15/-0.05
	212	2.0+0.15/-0.05	1.25+0.15/-0.05	0.45±0.05
				0.85±0.10
				1.25+0.15/-0.05
316	3.2±0.20	1.6±0.20	0.85±0.10	
325	3.2±0.30	2.5±0.30	1.6±0.20	
B	063	0.6±0.09	0.3±0.09	2.5±0.30
	105	1.0+0.15/-0.05	0.5+0.15/-0.05	0.3±0.09
	107	1.6+0.20/-0	0.8+0.20/-0	0.45±0.05
				0.8+0.20/-0
	212	2.0+0.20/-0	1.25+0.20/-0	0.45±0.05
0.85±0.10				
316	3.2±0.30	1.6±0.30	1.25+0.20/-0	
C	105	1.0+0.20/-0	0.5+0.20/-0	1.6±0.30
				0.5+0.20/-0

Note: cf. STANDARD EXTERNAL DIMENSIONS

△= Blank space

⑥ Temperature characteristics code

■ High dielectric type (Excluding Super low distortion multilayer ceramic capacitor)

Code	Applicable standard	Temperature range [°C]	Ref. Temp. [°C]	Capacitance change	Capacitance tolerance	Tolerance code
BJ	JIS	B	-25~+85	20	±10%	K
						M
	EIA	X5R	-55~+85	25	±15%	K
B7	EIA	X7R	-55~+125	25	±15%	M
						K
C6	EIA	X6S	-55~+105	25	±22%	K
						M
C7	EIA	X7S	-55~+125	25	±22%	K
						M
LD(※)	EIA	X5R	-55~+85	25	±15%	K
						M

Note : ※LD Low distortion high value multilayer ceramic capacitor

△= Blank space

■ Temperature compensating type

Code	Applicable standard		Temperature range [°C]	Ref. Temp. [°C]	Capacitance change	Capacitance tolerance	Tolerance code
CG	EIA	C0G	-55 ~ +125	25	0 ± 30ppm/°C	± 0.05pF	A
						± 0.1pF	B
						± 0.25pF	C
						± 0.5pF	D
						± 5%	J
UJ	JIS	UJ	-55 ~ +125	20	-750 ± 120ppm/°C	± 0.25pF	C
						± 0.5pF	D
	EIA	U2J		25		± 5%	J
UK	JIS	UK	-55 ~ +125	20	-750 ± 250ppm/°C	± 0.25pF	C
	EIA	U2K	-55 ~ +125	25			
SL	JIS	SL	-55 ~ +125	20	+350 ~ -1000ppm/°C	± 5%	J

⑥ Series code

• Super low distortion multilayer ceramic capacitor

Code	Series code
SD	Standard

• Medium-High Voltage Multilayer Ceramic Capacitor

Code	Series code
SD	Standard

⑦ Nominal capacitance

Code (example)	Nominal capacitance
0R5	0.5pF
010	1pF
100	10pF
101	100pF
102	1,000pF
103	10,000pF
104	0.1 μF
105	1.0 μF
106	10 μF
107	100 μF

Note : R=Decimal point

⑧ Capacitance tolerance

Code	Capacitance tolerance
A	± 0.05pF
B	± 0.1pF
C	± 0.25pF
D	± 0.5pF
F	± 1pF
G	± 2%
J	± 5%
K	± 10%
M	± 20%
Z	+80 / -20%

⑨ Thickness

Code	Thickness [mm]
K	0.125
H	0.13
E	0.18
C	0.2
D	
P	0.3
T	
K	0.45 (107type or more)
V	0.5
W	
A	0.8
D	0.85 (212type or more)
F	1.15
G	1.25
L	1.6
N	1.9
Y	2.0 max
M	2.5

⑩ Special code

Code	Special code
-	Standard

⑪ Packaging

Code	Packaging
F	φ178mm Taping (2mm pitch)
T	φ178mm Taping (4mm pitch)
P	φ178mm Taping (4mm pitch, 1000 pcs/reel) 325 type (Thickness code M)
R	φ178mm Taping (2mm pitch) 105type only (Thickness code E,H)
W	φ178mm Taping (1mm pitch) 021/042type only

⑫ Internal code

Code	Internal code
△	Standard

► This catalog contains the typical specification only due to the limitation of space. When you consider the purchase of our products, please check our product specification sheets. For details of each product (characteristics graph, reliability information, precautions for use, and so on), see our website (<http://www.ty-top.com/>).

■ STANDARD EXTERNAL DIMENSIONS

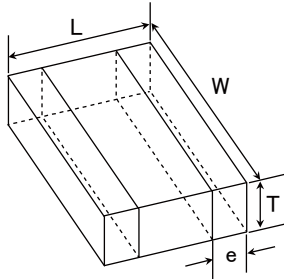
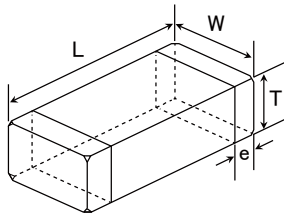

※ LW reverse type

Type(EIA)	Dimension [mm]					
	L	W	T	*1	e	
□MK021(008004)	0.25±0.013	0.125±0.013	0.125±0.013	K	0.0675±0.0275	
□VS021(008004)	0.25±0.013	0.125±0.013	0.125±0.013	K	0.0675±0.0275	
□MK042(01005)	0.4±0.02	0.2±0.02	0.2±0.02	C	0.1±0.03	
□VS042(01005)				D		
□MK063(0201)	0.6±0.03	0.3±0.03	0.3±0.03	P	0.15±0.05	
□MK105(0402)				T		
□MK105(0402)	1.0±0.05	0.5±0.05	0.5±0.05	0.13±0.02	H	0.25±0.10
				0.18±0.02	E	
				0.2±0.02	C	
				0.3±0.03	P	
				0.5±0.05	V	
□VK105(0402)	1.0±0.05	0.5±0.05	0.5±0.05	W	0.25±0.10	
□WK105(0204)※	0.52±0.05	1.0±0.05	0.3±0.05	P	0.18±0.08	
□MK107(0603)	1.6±0.10	0.8±0.10	0.8±0.10	0.45±0.05	K	0.35±0.25
				0.8±0.10	A	
□WK107(0306)※	0.8±0.10	1.6±0.10	0.5±0.05	V	0.25±0.15	
□MK212(0805)	2.0±0.10	1.25±0.10	1.25±0.10	0.45±0.05	K	0.5±0.25
				0.85±0.10	D	
				1.25±0.10	G	
□WK212(0508)※	1.25±0.15	2.0±0.15	0.85±0.10	D	0.3±0.2	
□MK316(1206)	3.2±0.15	1.6±0.15	1.6±0.15	0.85±0.10	D	0.5+0.35/-0.25
				1.15±0.10	F	
				1.6±0.20	L	
□MK325(1210)	3.2±0.30	2.5±0.20	2.5±0.20	0.85±0.10	D	0.6±0.3
				1.15±0.10	F	
				1.9±0.20	N	
				1.9+0.1/-0.2	Y	
□MK432(1812)	4.5±0.40	3.2±0.30	2.5±0.20	M	0.9±0.6	

Note : ※. LW reverse type, *1.Thickness code

■ STANDARD QUANTITY

Type	EIA (inch)	Dimension		Standard quantity [pcs]			
		[mm]	Code	Paper tape	Embossed tape		
021	008004	0.125	K	—	50000		
042	01005	0.2	C	—	40000		
			D				
063	0201	0.3	P	15000	—		
			T				
105	0402	0.13	H	—	20000		
			E	—	15000		
			C	20000	—		
			P	15000	—		
			V	10000	—		
	W	—					
	0204 ※	0.30	P	—	—		
107	0603	0.45	K	4000	—		
			A				
	0306 ※	0.50	V	—	4000		
212	0805	0.85	K	4000	—		
			D				
	0508 ※	1.25	G	—	3000		
316	1206	0.85	D	4000	—		
			F			—	3000
			L			—	2000
325	1210	2.0 max	D	—	2000		
			F				
			N				
			Y				
432	1812	2.5	M	—	1000		
			M	—	500		

Note : ※.LW Reverse type(□WK)

▶ This catalog contains the typical specification only due to the limitation of space. When you consider the purchase of our products, please check our product specification sheets. For details of each product (characteristics graph, reliability information, precautions for use, and so on), see our website (<http://www.ty-top.com/>).

Multilayer Ceramic Capacitors (Temperature compensating type)

● 021TYPE

【Temperature Characteristic CG : CG/C0G】 0.125mm thickness (K)

Part number 1	Part number 2	Rated voltage [V]	Temperature characteristics	Capacitance [F]	Capacitance tolerance	Q (at 1MHz) min	HTLT		Thickness ^{*3} [mm]	Soldering R:Reflow W:Wave
							Rated voltage x %			
TMK021 CG0R2[K-W]		25	CG C0G	0.2 p	±0.1pF, ±0.25pF	404	200	0.125±0.013	R	
TMK021 CG0R3[K-W]			CG C0G	0.3 p	±0.1pF, ±0.25pF	406	200	0.125±0.013	R	
TMK021 CG0R4[K-W]			CG C0G	0.4 p	±0.1pF, ±0.25pF	408	200	0.125±0.013	R	
TMK021 CG0R5[K-W]			CG C0G	0.5 p	±0.1pF, ±0.25pF	410	200	0.125±0.013	R	
TMK021 CG0R6[K-W]			CG C0G	0.6 p	±0.1pF, ±0.25pF	412	200	0.125±0.013	R	
TMK021 CG0R7[K-W]			CG C0G	0.7 p	±0.1pF, ±0.25pF	414	200	0.125±0.013	R	
TMK021 CGR75[K-W]			CG C0G	0.75 p	±0.1pF, ±0.25pF	415	200	0.125±0.013	R	
TMK021 CG0R8[K-W]			CG C0G	0.8 p	±0.1pF, ±0.25pF	416	200	0.125±0.013	R	
TMK021 CG0R9[K-W]			CG C0G	0.9 p	±0.1pF, ±0.25pF	418	200	0.125±0.013	R	
TMK021 CG010[K-W]			CG C0G	1 p	±0.1pF, ±0.25pF	420	200	0.125±0.013	R	
TMK021 CG1R1[K-W]			CG C0G	1.1 p	±0.1pF, ±0.25pF	422	200	0.125±0.013	R	
TMK021 CG1R2[K-W]			CG C0G	1.2 p	±0.1pF, ±0.25pF	424	200	0.125±0.013	R	
TMK021 CG1R3[K-W]			CG C0G	1.3 p	±0.1pF, ±0.25pF	426	200	0.125±0.013	R	
TMK021 CG1R4[K-W]			CG C0G	1.4 p	±0.1pF, ±0.25pF	428	200	0.125±0.013	R	
TMK021 CG1R5[K-W]			CG C0G	1.5 p	±0.1pF, ±0.25pF	430	200	0.125±0.013	R	
TMK021 CG1R6[K-W]			CG C0G	1.6 p	±0.1pF, ±0.25pF	432	200	0.125±0.013	R	
TMK021 CG1R7[K-W]			CG C0G	1.7 p	±0.1pF, ±0.25pF	434	200	0.125±0.013	R	
TMK021 CG1R8[K-W]			CG C0G	1.8 p	±0.1pF, ±0.25pF	436	200	0.125±0.013	R	
TMK021 CG1R9[K-W]			CG C0G	1.9 p	±0.1pF, ±0.25pF	438	200	0.125±0.013	R	
TMK021 CG020[K-W]			CG C0G	2 p	±0.1pF, ±0.25pF	440	200	0.125±0.013	R	
TMK021 CG2R1[K-W]			CG C0G	2.1 p	±0.1pF, ±0.25pF	442	200	0.125±0.013	R	
TMK021 CG2R2[K-W]			CG C0G	2.2 p	±0.1pF, ±0.25pF	444	200	0.125±0.013	R	
TMK021 CG2R3[K-W]			CG C0G	2.3 p	±0.1pF, ±0.25pF	446	200	0.125±0.013	R	
TMK021 CG2R4[K-W]			CG C0G	2.4 p	±0.1pF, ±0.25pF	448	200	0.125±0.013	R	
TMK021 CG2R5[K-W]			CG C0G	2.5 p	±0.1pF, ±0.25pF	450	200	0.125±0.013	R	
TMK021 CG2R6[K-W]			CG C0G	2.6 p	±0.1pF, ±0.25pF	452	200	0.125±0.013	R	
TMK021 CG2R7[K-W]			CG C0G	2.7 p	±0.1pF, ±0.25pF	454	200	0.125±0.013	R	
TMK021 CG2R8[K-W]			CG C0G	2.8 p	±0.1pF, ±0.25pF	456	200	0.125±0.013	R	
TMK021 CG2R9[K-W]			CG C0G	2.9 p	±0.1pF, ±0.25pF	458	200	0.125±0.013	R	
TMK021 CG030[K-W]			CG C0G	3 p	±0.1pF, ±0.25pF	460	200	0.125±0.013	R	
TMK021 CG3R1[K-W]			CG C0G	3.1 p	±0.1pF, ±0.25pF	462	200	0.125±0.013	R	
TMK021 CG3R2[K-W]			CG C0G	3.2 p	±0.1pF, ±0.25pF	464	200	0.125±0.013	R	
TMK021 CG3R3[K-W]			CG C0G	3.3 p	±0.1pF, ±0.25pF	466	200	0.125±0.013	R	
TMK021 CG3R4[K-W]			CG C0G	3.4 p	±0.1pF, ±0.25pF	468	200	0.125±0.013	R	
TMK021 CG3R5[K-W]			CG C0G	3.5 p	±0.1pF, ±0.25pF	470	200	0.125±0.013	R	
TMK021 CG3R6[K-W]			CG C0G	3.6 p	±0.1pF, ±0.25pF	472	200	0.125±0.013	R	
TMK021 CG3R7[K-W]			CG C0G	3.7 p	±0.1pF, ±0.25pF	474	200	0.125±0.013	R	
TMK021 CG3R8[K-W]			CG C0G	3.8 p	±0.1pF, ±0.25pF	476	200	0.125±0.013	R	
TMK021 CG3R9[K-W]			CG C0G	3.9 p	±0.1pF, ±0.25pF	478	200	0.125±0.013	R	
TMK021 CG040[K-W]			CG C0G	4 p	±0.1pF, ±0.25pF	480	200	0.125±0.013	R	
TMK021 CG4R1[K-W]			CG C0G	4.1 p	±0.1pF, ±0.25pF	482	200	0.125±0.013	R	
TMK021 CG4R2[K-W]			CG C0G	4.2 p	±0.1pF, ±0.25pF	484	200	0.125±0.013	R	
TMK021 CG4R3[K-W]			CG C0G	4.3 p	±0.1pF, ±0.25pF	486	200	0.125±0.013	R	
TMK021 CG4R4[K-W]			CG C0G	4.4 p	±0.1pF, ±0.25pF	488	200	0.125±0.013	R	
TMK021 CG4R5[K-W]			CG C0G	4.5 p	±0.1pF, ±0.25pF	490	200	0.125±0.013	R	
TMK021 CG4R6[K-W]			CG C0G	4.6 p	±0.1pF, ±0.25pF	492	200	0.125±0.013	R	
TMK021 CG4R7[K-W]			CG C0G	4.7 p	±0.1pF, ±0.25pF	494	200	0.125±0.013	R	
TMK021 CG4R8[K-W]			CG C0G	4.8 p	±0.1pF, ±0.25pF	496	200	0.125±0.013	R	
TMK021 CG4R9[K-W]			CG C0G	4.9 p	±0.1pF, ±0.25pF	498	200	0.125±0.013	R	
TMK021 CG050[K-W]			CG C0G	5 p	±0.1pF, ±0.25pF	500	200	0.125±0.013	R	
TMK021 CG5R1[K-W]		CG C0G	5.1 p	±0.25pF, ±0.5pF	502	200	0.125±0.013	R		
TMK021 CG5R2[K-W]		CG C0G	5.2 p	±0.25pF, ±0.5pF	504	200	0.125±0.013	R		
TMK021 CG5R3[K-W]		CG C0G	5.3 p	±0.25pF, ±0.5pF	506	200	0.125±0.013	R		
TMK021 CG5R4[K-W]		CG C0G	5.4 p	±0.25pF, ±0.5pF	508	200	0.125±0.013	R		
TMK021 CG5R5[K-W]		CG C0G	5.5 p	±0.25pF, ±0.5pF	510	200	0.125±0.013	R		
TMK021 CG5R6[K-W]		CG C0G	5.6 p	±0.25pF, ±0.5pF	512	200	0.125±0.013	R		
TMK021 CG5R7[K-W]		CG C0G	5.7 p	±0.25pF, ±0.5pF	514	200	0.125±0.013	R		
TMK021 CG5R8[K-W]		CG C0G	5.8 p	±0.25pF, ±0.5pF	516	200	0.125±0.013	R		
TMK021 CG5R9[K-W]		CG C0G	5.9 p	±0.25pF, ±0.5pF	518	200	0.125±0.013	R		
TMK021 CG060[K-W]		CG C0G	6 p	±0.25pF, ±0.5pF	520	200	0.125±0.013	R		
TMK021 CG6R1[K-W]		CG C0G	6.1 p	±0.25pF, ±0.5pF	522	200	0.125±0.013	R		
TMK021 CG6R2[K-W]		CG C0G	6.2 p	±0.25pF, ±0.5pF	524	200	0.125±0.013	R		
TMK021 CG6R3[K-W]		CG C0G	6.3 p	±0.25pF, ±0.5pF	526	200	0.125±0.013	R		
TMK021 CG6R4[K-W]		CG C0G	6.4 p	±0.25pF, ±0.5pF	528	200	0.125±0.013	R		
TMK021 CG6R5[K-W]		CG C0G	6.5 p	±0.25pF, ±0.5pF	530	200	0.125±0.013	R		
TMK021 CG6R6[K-W]		CG C0G	6.6 p	±0.25pF, ±0.5pF	532	200	0.125±0.013	R		
TMK021 CG6R7[K-W]		CG C0G	6.7 p	±0.25pF, ±0.5pF	534	200	0.125±0.013	R		
TMK021 CG6R8[K-W]		CG C0G	6.8 p	±0.25pF, ±0.5pF	536	200	0.125±0.013	R		
TMK021 CG6R9[K-W]		CG C0G	6.9 p	±0.25pF, ±0.5pF	538	200	0.125±0.013	R		
TMK021 CG070[K-W]		CG C0G	7 p	±0.25pF, ±0.5pF	540	200	0.125±0.013	R		
TMK021 CG7R1[K-W]		CG C0G	7.1 p	±0.25pF, ±0.5pF	542	200	0.125±0.013	R		
TMK021 CG7R2[K-W]		CG C0G	7.2 p	±0.25pF, ±0.5pF	544	200	0.125±0.013	R		
TMK021 CG7R3[K-W]		CG C0G	7.3 p	±0.25pF, ±0.5pF	546	200	0.125±0.013	R		
TMK021 CG7R4[K-W]		CG C0G	7.4 p	±0.25pF, ±0.5pF	548	200	0.125±0.013	R		
TMK021 CG7R5[K-W]		CG C0G	7.5 p	±0.25pF, ±0.5pF	550	200	0.125±0.013	R		
TMK021 CG7R6[K-W]		CG C0G	7.6 p	±0.25pF, ±0.5pF	552	200	0.125±0.013	R		
TMK021 CG7R7[K-W]		CG C0G	7.7 p	±0.25pF, ±0.5pF	554	200	0.125±0.013	R		
TMK021 CG7R8[K-W]		CG C0G	7.8 p	±0.25pF, ±0.5pF	556	200	0.125±0.013	R		
TMK021 CG7R9[K-W]		CG C0G	7.9 p	±0.25pF, ±0.5pF	558	200	0.125±0.013	R		
TMK021 CG080[K-W]		CG C0G	8 p	±0.25pF, ±0.5pF	560	200	0.125±0.013	R		
TMK021 CG8R1[K-W]		CG C0G	8.1 p	±0.25pF, ±0.5pF	562	200	0.125±0.013	R		
TMK021 CG8R2[K-W]		CG C0G	8.2 p	±0.25pF, ±0.5pF	564	200	0.125±0.013	R		
TMK021 CG8R3[K-W]		CG C0G	8.3 p	±0.25pF, ±0.5pF	566	200	0.125±0.013	R		
TMK021 CG8R4[K-W]		CG C0G	8.4 p	±0.25pF, ±0.5pF	568	200	0.125±0.013	R		
TMK021 CG8R5[K-W]		CG C0G	8.5 p	±0.25pF, ±0.5pF	570	200	0.125±0.013	R		

■ PARTS NUMBER

Part number 1	Part number 2	Rated voltage [V]	Temperature characteristics		Capacitance [F]	Capacitance tolerance	Q (at 1MHz) min	HTLT	Thickness ^{*3} [mm]	Soldering R:Reflow W:Wave
								Rated voltage x %		
TMK021 CG8R6□K-W		25	CG	COG	8.6 p	±0.25pF, ±0.5pF	572	200	0.125±0.013	R
TMK021 CG8R7□K-W			CG	COG	8.7 p	±0.25pF, ±0.5pF	574	200	0.125±0.013	R
TMK021 CG8R8□K-W			CG	COG	8.8 p	±0.25pF, ±0.5pF	576	200	0.125±0.013	R
TMK021 CG8R9□K-W			CG	COG	8.9 p	±0.25pF, ±0.5pF	578	200	0.125±0.013	R
TMK021 CG090□K-W			CG	COG	9 p	±0.25pF, ±0.5pF	580	200	0.125±0.013	R
TMK021 CG9R1□K-W			CG	COG	9.1 p	±0.25pF, ±0.5pF	582	200	0.125±0.013	R
TMK021 CG9R2□K-W			CG	COG	9.2 p	±0.25pF, ±0.5pF	584	200	0.125±0.013	R
TMK021 CG9R3□K-W			CG	COG	9.3 p	±0.25pF, ±0.5pF	586	200	0.125±0.013	R
TMK021 CG9R4□K-W			CG	COG	9.4 p	±0.25pF, ±0.5pF	588	200	0.125±0.013	R
TMK021 CG9R5□K-W			CG	COG	9.5 p	±0.25pF, ±0.5pF	590	200	0.125±0.013	R
TMK021 CG9R6□K-W			CG	COG	9.6 p	±0.25pF, ±0.5pF	592	200	0.125±0.013	R
TMK021 CG9R7□K-W			CG	COG	9.7 p	±0.25pF, ±0.5pF	594	200	0.125±0.013	R
TMK021 CG9R8□K-W			CG	COG	9.8 p	±0.25pF, ±0.5pF	596	200	0.125±0.013	R
TMK021 CG9R9□K-W			CG	COG	9.9 p	±0.25pF, ±0.5pF	598	200	0.125±0.013	R
TMK021 CG100DK-W			CG	COG	10 p	±0.5pF	600	200	0.125±0.013	R
TMK021 CG120JK-W			CG	COG	12 p	±5%	640	200	0.125±0.013	R
TMK021 CG150JK-W			CG	COG	15 p	±5%	700	200	0.125±0.013	R
TMK021 CG180JK-W			CG	COG	18 p	±5%	760	200	0.125±0.013	R
TMK021 CG220JK-W			CG	COG	22 p	±5%	840	200	0.125±0.013	R
TMK021 CG270JK-W			CG	COG	27 p	±5%	940	200	0.125±0.013	R
EMK021 CG330JK-W		16	CG	COG	33 p	±5%	1000	150	0.125±0.013	R
EMK021 CG390JK-W			CG	COG	39 p	±5%	1000	150	0.125±0.013	R
EMK021 CG470JK-W			CG	COG	47 p	±5%	1000	150	0.125±0.013	R
EMK021 CG560JK-W			CG	COG	56 p	±5%	1000	150	0.125±0.013	R

● 042TYPE

[Temperature Characteristic CG : CG/COG] 0.2mm thickness (C,D)

Part number 1	Part number 2	Rated voltage [V]	Temperature characteristics		Capacitance [F]	Capacitance tolerance	Q (at 1MHz) min	HTLT	Thickness ^{*3} [mm]	Soldering R:Reflow W:Wave
								Rated voltage x %		
TMK042 CG0R4□D-W		25	CG	COG	0.4 p	±0.05pF, ±0.1pF, ±0.25pF	408	200	0.2±0.02	R
TMK042 CG0R5□D-W			CG	COG	0.5 p	±0.05pF, ±0.1pF, ±0.25pF	410	200	0.2±0.02	R
TMK042 CG0R6□D-W			CG	COG	0.6 p	±0.05pF, ±0.1pF, ±0.25pF	412	200	0.2±0.02	R
TMK042 CG0R7□D-W			CG	COG	0.7 p	±0.05pF, ±0.1pF, ±0.25pF	414	200	0.2±0.02	R
TMK042 CGR75□D-W			CG	COG	0.75 p	±0.05pF, ±0.1pF, ±0.25pF	415	200	0.2±0.02	R
TMK042 CG0R8□D-W			CG	COG	0.8 p	±0.05pF, ±0.1pF, ±0.25pF	416	200	0.2±0.02	R
TMK042 CG0R9□D-W			CG	COG	0.9 p	±0.05pF, ±0.1pF, ±0.25pF	418	200	0.2±0.02	R
TMK042 CG010□D-W			CG	COG	1 p	±0.05pF, ±0.1pF, ±0.25pF	420	200	0.2±0.02	R
TMK042 CG1R1□D-W			CG	COG	1.1 p	±0.05pF, ±0.1pF, ±0.25pF	422	200	0.2±0.02	R
TMK042 CG1R2□D-W			CG	COG	1.2 p	±0.05pF, ±0.1pF, ±0.25pF	424	200	0.2±0.02	R
TMK042 CG1R3□D-W			CG	COG	1.3 p	±0.05pF, ±0.1pF, ±0.25pF	426	200	0.2±0.02	R
TMK042 CG1R4□D-W			CG	COG	1.4 p	±0.05pF, ±0.1pF, ±0.25pF	428	200	0.2±0.02	R
TMK042 CG1R5□D-W			CG	COG	1.5 p	±0.05pF, ±0.1pF, ±0.25pF	430	200	0.2±0.02	R
TMK042 CG1R6□D-W			CG	COG	1.6 p	±0.05pF, ±0.1pF, ±0.25pF	432	200	0.2±0.02	R
TMK042 CG1R7□D-W			CG	COG	1.7 p	±0.05pF, ±0.1pF, ±0.25pF	434	200	0.2±0.02	R
TMK042 CG1R8□D-W			CG	COG	1.8 p	±0.05pF, ±0.1pF, ±0.25pF	436	200	0.2±0.02	R
TMK042 CG1R9□D-W			CG	COG	1.9 p	±0.05pF, ±0.1pF, ±0.25pF	438	200	0.2±0.02	R
TMK042 CG020□D-W			CG	COG	2 p	±0.05pF, ±0.1pF, ±0.25pF	440	200	0.2±0.02	R
TMK042 CG2R1□D-W			CG	COG	2.1 p	±0.05pF, ±0.1pF, ±0.25pF	442	200	0.2±0.02	R
TMK042 CG2R2□D-W			CG	COG	2.2 p	±0.05pF, ±0.1pF, ±0.25pF	444	200	0.2±0.02	R
TMK042 CG2R3□D-W			CG	COG	2.3 p	±0.05pF, ±0.1pF, ±0.25pF	446	200	0.2±0.02	R
TMK042 CG2R4□D-W			CG	COG	2.4 p	±0.05pF, ±0.1pF, ±0.25pF	448	200	0.2±0.02	R
TMK042 CG2R5□D-W			CG	COG	2.5 p	±0.05pF, ±0.1pF, ±0.25pF	450	200	0.2±0.02	R
TMK042 CG2R6□D-W			CG	COG	2.6 p	±0.05pF, ±0.1pF, ±0.25pF	452	200	0.2±0.02	R
TMK042 CG2R7□D-W			CG	COG	2.7 p	±0.05pF, ±0.1pF, ±0.25pF	454	200	0.2±0.02	R
TMK042 CG2R8□D-W			CG	COG	2.8 p	±0.05pF, ±0.1pF, ±0.25pF	456	200	0.2±0.02	R
TMK042 CG2R9□D-W			CG	COG	2.9 p	±0.05pF, ±0.1pF, ±0.25pF	458	200	0.2±0.02	R
TMK042 CG030□D-W			CG	COG	3 p	±0.05pF, ±0.1pF, ±0.25pF	460	200	0.2±0.02	R
TMK042 CG3R1□D-W			CG	COG	3.1 p	±0.1pF, ±0.25pF	462	200	0.2±0.02	R
TMK042 CG3R2□D-W			CG	COG	3.2 p	±0.1pF, ±0.25pF	464	200	0.2±0.02	R
TMK042 CG3R3□D-W			CG	COG	3.3 p	±0.1pF, ±0.25pF	466	200	0.2±0.02	R
TMK042 CG3R4□D-W			CG	COG	3.4 p	±0.1pF, ±0.25pF	468	200	0.2±0.02	R
TMK042 CG3R5□D-W			CG	COG	3.5 p	±0.1pF, ±0.25pF	470	200	0.2±0.02	R
TMK042 CG3R6□D-W			CG	COG	3.6 p	±0.1pF, ±0.25pF	472	200	0.2±0.02	R
TMK042 CG3R7□D-W			CG	COG	3.7 p	±0.1pF, ±0.25pF	474	200	0.2±0.02	R
TMK042 CG3R8□D-W			CG	COG	3.8 p	±0.1pF, ±0.25pF	476	200	0.2±0.02	R
TMK042 CG3R9□D-W			CG	COG	3.9 p	±0.1pF, ±0.25pF	478	200	0.2±0.02	R
TMK042 CG040□D-W			CG	COG	4 p	±0.1pF, ±0.25pF	480	200	0.2±0.02	R
TMK042 CG4R1□D-W			CG	COG	4.1 p	±0.1pF, ±0.25pF	482	200	0.2±0.02	R
TMK042 CG4R2□D-W			CG	COG	4.2 p	±0.1pF, ±0.25pF	484	200	0.2±0.02	R
TMK042 CG4R3□D-W			CG	COG	4.3 p	±0.1pF, ±0.25pF	486	200	0.2±0.02	R
TMK042 CG4R4□D-W			CG	COG	4.4 p	±0.1pF, ±0.25pF	488	200	0.2±0.02	R
TMK042 CG4R5□D-W			CG	COG	4.5 p	±0.1pF, ±0.25pF	490	200	0.2±0.02	R
TMK042 CG4R6□D-W			CG	COG	4.6 p	±0.1pF, ±0.25pF	492	200	0.2±0.02	R
TMK042 CG4R7□D-W			CG	COG	4.7 p	±0.1pF, ±0.25pF	494	200	0.2±0.02	R
TMK042 CG4R8□D-W			CG	COG	4.8 p	±0.1pF, ±0.25pF	496	200	0.2±0.02	R
TMK042 CG4R9□D-W			CG	COG	4.9 p	±0.1pF, ±0.25pF	498	200	0.2±0.02	R
TMK042 CG050□D-W			CG	COG	5 p	±0.1pF, ±0.25pF	500	200	0.2±0.02	R
TMK042 CG5R1□D-W			CG	COG	5.1 p	±0.1pF, ±0.25pF, ±0.5pF	502	200	0.2±0.02	R
TMK042 CG5R2□D-W			CG	COG	5.2 p	±0.1pF, ±0.25pF, ±0.5pF	504	200	0.2±0.02	R
TMK042 CG5R3□D-W			CG	COG	5.3 p	±0.1pF, ±0.25pF, ±0.5pF	506	200	0.2±0.02	R
TMK042 CG5R4□D-W			CG	COG	5.4 p	±0.1pF, ±0.25pF, ±0.5pF	508	200	0.2±0.02	R
TMK042 CG5R5□D-W			CG	COG	5.5 p	±0.1pF, ±0.25pF, ±0.5pF	510	200	0.2±0.02	R
TMK042 CG5R6□D-W			CG	COG	5.6 p	±0.1pF, ±0.25pF, ±0.5pF	512	200	0.2±0.02	R
TMK042 CG5R7□D-W			CG	COG	5.7 p	±0.1pF, ±0.25pF, ±0.5pF	514	200	0.2±0.02	R
TMK042 CG5R8□D-W			CG	COG	5.8 p	±0.1pF, ±0.25pF, ±0.5pF	516	200	0.2±0.02	R
TMK042 CG5R9□D-W			CG	COG	5.9 p	±0.1pF, ±0.25pF, ±0.5pF	518	200	0.2±0.02	R
TMK042 CG060□D-W			CG	COG	6 p	±0.1pF, ±0.25pF, ±0.5pF	520	200	0.2±0.02	R

▶ This catalog contains the typical specification only due to the limitation of space. When you consider the purchase of our products, please check our product specification sheets. For details of each product (characteristics graph, reliability information, precautions for use, and so on), see our website (<http://www.ty-top.com/>).

PARTS NUMBER

Part number 1	Part number 2	Rated voltage [V]	Temperature characteristics	Capacitance [F]	Capacitance tolerance	Q (at 1MHz) min	HTLT	Thickness*3 [mm]	Soldering R:Reflow W:Wave
							Rated voltage x %		
TMK042 CG6R1[D-W]		25	CG C0G	6.1 p	±0.1pF, ±0.25pF, ±0.5pF	522	200	0.2±0.02	R
TMK042 CG6R2[D-W]			CG C0G	6.2 p	±0.1pF, ±0.25pF, ±0.5pF	524	200	0.2±0.02	R
TMK042 CG6R3[D-W]			CG C0G	6.3 p	±0.1pF, ±0.25pF, ±0.5pF	526	200	0.2±0.02	R
TMK042 CG6R4[D-W]			CG C0G	6.4 p	±0.1pF, ±0.25pF, ±0.5pF	528	200	0.2±0.02	R
TMK042 CG6R5[D-W]			CG C0G	6.5 p	±0.1pF, ±0.25pF, ±0.5pF	530	200	0.2±0.02	R
TMK042 CG6R6[D-W]			CG C0G	6.6 p	±0.1pF, ±0.25pF, ±0.5pF	532	200	0.2±0.02	R
TMK042 CG6R7[D-W]			CG C0G	6.7 p	±0.1pF, ±0.25pF, ±0.5pF	534	200	0.2±0.02	R
TMK042 CG6R8[D-W]			CG C0G	6.8 p	±0.1pF, ±0.25pF, ±0.5pF	536	200	0.2±0.02	R
TMK042 CG6R9[D-W]			CG C0G	6.9 p	±0.1pF, ±0.25pF, ±0.5pF	538	200	0.2±0.02	R
TMK042 CG070[D-W]			CG C0G	7 p	±0.1pF, ±0.25pF, ±0.5pF	540	200	0.2±0.02	R
TMK042 CG7R1[D-W]			CG C0G	7.1 p	±0.1pF, ±0.25pF, ±0.5pF	542	200	0.2±0.02	R
TMK042 CG7R2[D-W]			CG C0G	7.2 p	±0.1pF, ±0.25pF, ±0.5pF	544	200	0.2±0.02	R
TMK042 CG7R3[D-W]			CG C0G	7.3 p	±0.1pF, ±0.25pF, ±0.5pF	546	200	0.2±0.02	R
TMK042 CG7R4[D-W]			CG C0G	7.4 p	±0.1pF, ±0.25pF, ±0.5pF	548	200	0.2±0.02	R
TMK042 CG7R5[D-W]			CG C0G	7.5 p	±0.1pF, ±0.25pF, ±0.5pF	550	200	0.2±0.02	R
TMK042 CG7R6[D-W]			CG C0G	7.6 p	±0.1pF, ±0.25pF, ±0.5pF	552	200	0.2±0.02	R
TMK042 CG7R7[D-W]			CG C0G	7.7 p	±0.1pF, ±0.25pF, ±0.5pF	554	200	0.2±0.02	R
TMK042 CG7R8[D-W]			CG C0G	7.8 p	±0.1pF, ±0.25pF, ±0.5pF	556	200	0.2±0.02	R
TMK042 CG7R9[D-W]			CG C0G	7.9 p	±0.1pF, ±0.25pF, ±0.5pF	558	200	0.2±0.02	R
TMK042 CG080[D-W]			CG C0G	8 p	±0.1pF, ±0.25pF, ±0.5pF	560	200	0.2±0.02	R
TMK042 CG8R1[D-W]			CG C0G	8.1 p	±0.1pF, ±0.25pF, ±0.5pF	562	200	0.2±0.02	R
TMK042 CG8R2[D-W]			CG C0G	8.2 p	±0.1pF, ±0.25pF, ±0.5pF	564	200	0.2±0.02	R
TMK042 CG8R3[D-W]			CG C0G	8.3 p	±0.1pF, ±0.25pF, ±0.5pF	566	200	0.2±0.02	R
TMK042 CG8R4[D-W]			CG C0G	8.4 p	±0.1pF, ±0.25pF, ±0.5pF	568	200	0.2±0.02	R
TMK042 CG8R5[D-W]			CG C0G	8.5 p	±0.1pF, ±0.25pF, ±0.5pF	570	200	0.2±0.02	R
TMK042 CG8R6[D-W]			CG C0G	8.6 p	±0.1pF, ±0.25pF, ±0.5pF	572	200	0.2±0.02	R
TMK042 CG8R7[D-W]			CG C0G	8.7 p	±0.1pF, ±0.25pF, ±0.5pF	574	200	0.2±0.02	R
TMK042 CG8R8[D-W]			CG C0G	8.8 p	±0.1pF, ±0.25pF, ±0.5pF	576	200	0.2±0.02	R
TMK042 CG8R9[D-W]			CG C0G	8.9 p	±0.1pF, ±0.25pF, ±0.5pF	578	200	0.2±0.02	R
TMK042 CG090[D-W]			CG C0G	9 p	±0.1pF, ±0.25pF, ±0.5pF	580	200	0.2±0.02	R
TMK042 CG9R1[D-W]			CG C0G	9.1 p	±0.1pF, ±0.25pF, ±0.5pF	582	200	0.2±0.02	R
TMK042 CG9R2[D-W]			CG C0G	9.2 p	±0.1pF, ±0.25pF, ±0.5pF	584	200	0.2±0.02	R
TMK042 CG9R3[D-W]			CG C0G	9.3 p	±0.1pF, ±0.25pF, ±0.5pF	586	200	0.2±0.02	R
TMK042 CG9R4[D-W]			CG C0G	9.4 p	±0.1pF, ±0.25pF, ±0.5pF	588	200	0.2±0.02	R
TMK042 CG9R5[D-W]			CG C0G	9.5 p	±0.1pF, ±0.25pF, ±0.5pF	590	200	0.2±0.02	R
TMK042 CG9R6[D-W]			CG C0G	9.6 p	±0.1pF, ±0.25pF, ±0.5pF	592	200	0.2±0.02	R
TMK042 CG9R7[D-W]			CG C0G	9.7 p	±0.1pF, ±0.25pF, ±0.5pF	594	200	0.2±0.02	R
TMK042 CG9R8[D-W]			CG C0G	9.8 p	±0.1pF, ±0.25pF, ±0.5pF	596	200	0.2±0.02	R
TMK042 CG9R9[D-W]			CG C0G	9.9 p	±0.1pF, ±0.25pF, ±0.5pF	598	200	0.2±0.02	R
TMK042 CG100DD-W			CG C0G	10 p	±5%	600	200	0.2±0.02	R
TMK042 CG110JD-W			CG C0G	11 p	±5%	620	200	0.2±0.02	R
TMK042 CG120JD-W			CG C0G	12 p	±5%	640	200	0.2±0.02	R
TMK042 CG130JD-W			CG C0G	13 p	±5%	660	200	0.2±0.02	R
TMK042 CG150JD-W			CG C0G	15 p	±5%	700	200	0.2±0.02	R
TMK042 CG160JC-W			CG C0G	16 p	±5%	720	200	0.2±0.02	R
TMK042 CG180JC-W			CG C0G	18 p	±5%	760	200	0.2±0.02	R
TMK042 CG200JC-W			CG C0G	20 p	±5%	800	200	0.2±0.02	R
TMK042 CG220JC-W			CG C0G	22 p	±5%	840	200	0.2±0.02	R
TMK042 CG240JC-W			CG C0G	24 p	±5%	880	200	0.2±0.02	R
TMK042 CG270JC-W			CG C0G	27 p	±5%	940	200	0.2±0.02	R
TMK042 CG300JC-W			CG C0G	30 p	±5%	1000	200	0.2±0.02	R
TMK042 CG330JC-W			CG C0G	33 p	±5%	1000	200	0.2±0.02	R
TMK042 CG360JC-W			CG C0G	36 p	±5%	1000	200	0.2±0.02	R
TMK042 CG390JC-W			CG C0G	39 p	±5%	1000	200	0.2±0.02	R
TMK042 CG430JC-W			CG C0G	43 p	±5%	1000	200	0.2±0.02	R
TMK042 CG470JC-W			CG C0G	47 p	±5%	1000	200	0.2±0.02	R
TMK042 CG510JC-W			CG C0G	51 p	±5%	1000	200	0.2±0.02	R
TMK042 CG560JC-W			CG C0G	56 p	±5%	1000	200	0.2±0.02	R
TMK042 CG620JC-W			CG C0G	62 p	±5%	1000	200	0.2±0.02	R
TMK042 CG680JC-W			CG C0G	68 p	±5%	1000	200	0.2±0.02	R
TMK042 CG750JC-W		CG C0G	75 p	±5%	1000	200	0.2±0.02	R	
TMK042 CG820JC-W		CG C0G	82 p	±5%	1000	200	0.2±0.02	R	
TMK042 CG910JC-W		CG C0G	91 p	±5%	1000	200	0.2±0.02	R	
TMK042 CG101JC-W		CG C0G	100 p	±5%	1000	200	0.2±0.02	R	

【Temperature Characteristic CG : CG/C0G】 0.2mm thickness (C,D)

Part number 1	Part number 2	Rated voltage [V]	Temperature characteristics	Capacitance [F]	Capacitance tolerance	Q (at 1MHz) min	HTLT	Thickness*3 [mm]	Soldering R:Reflow W:Wave
							Rated voltage x %		
EMK042 CG0R4[D-W]		16	CG C0G	0.4 p	±0.05pF, ±0.1pF, ±0.25pF	408	200	0.2±0.02	R
EMK042 CG0R5[D-W]			CG C0G	0.5 p	±0.05pF, ±0.1pF, ±0.25pF	410	200	0.2±0.02	R
EMK042 CG0R6[D-W]			CG C0G	0.6 p	±0.05pF, ±0.1pF, ±0.25pF	412	200	0.2±0.02	R
EMK042 CG0R7[D-W]			CG C0G	0.7 p	±0.05pF, ±0.1pF, ±0.25pF	414	200	0.2±0.02	R
EMK042 CGR75[D-W]			CG C0G	0.75 p	±0.05pF, ±0.1pF, ±0.25pF	415	200	0.2±0.02	R
EMK042 CG0R8[D-W]			CG C0G	0.8 p	±0.05pF, ±0.1pF, ±0.25pF	416	200	0.2±0.02	R
EMK042 CG0R9[D-W]			CG C0G	0.9 p	±0.05pF, ±0.1pF, ±0.25pF	418	200	0.2±0.02	R
EMK042 CG010[D-W]			CG C0G	1 p	±0.05pF, ±0.1pF, ±0.25pF	420	200	0.2±0.02	R
EMK042 CG1R1[D-W]			CG C0G	1.1 p	±0.05pF, ±0.1pF, ±0.25pF	422	200	0.2±0.02	R
EMK042 CG1R2[D-W]			CG C0G	1.2 p	±0.05pF, ±0.1pF, ±0.25pF	424	200	0.2±0.02	R
EMK042 CG1R3[D-W]			CG C0G	1.3 p	±0.05pF, ±0.1pF, ±0.25pF	426	200	0.2±0.02	R
EMK042 CG1R4[D-W]			CG C0G	1.4 p	±0.05pF, ±0.1pF, ±0.25pF	428	200	0.2±0.02	R
EMK042 CG1R5[D-W]			CG C0G	1.5 p	±0.05pF, ±0.1pF, ±0.25pF	430	200	0.2±0.02	R
EMK042 CG1R6[D-W]			CG C0G	1.6 p	±0.05pF, ±0.1pF, ±0.25pF	432	200	0.2±0.02	R
EMK042 CG1R7[D-W]			CG C0G	1.7 p	±0.05pF, ±0.1pF, ±0.25pF	434	200	0.2±0.02	R
EMK042 CG1R8[D-W]			CG C0G	1.8 p	±0.05pF, ±0.1pF, ±0.25pF	436	200	0.2±0.02	R
EMK042 CG1R9[D-W]			CG C0G	1.9 p	±0.05pF, ±0.1pF, ±0.25pF	438	200	0.2±0.02	R
EMK042 CG020[D-W]			CG C0G	2 p	±0.05pF, ±0.1pF, ±0.25pF	440	200	0.2±0.02	R
EMK042 CG2R1[D-W]			CG C0G	2.1 p	±0.05pF, ±0.1pF, ±0.25pF	442	200	0.2±0.02	R
EMK042 CG2R2[D-W]			CG C0G	2.2 p	±0.05pF, ±0.1pF, ±0.25pF	444	200	0.2±0.02	R
EMK042 CG2R3[D-W]			CG C0G	2.3 p	±0.05pF, ±0.1pF, ±0.25pF	446	200	0.2±0.02	R

▶ This catalog contains the typical specification only due to the limitation of space. When you consider the purchase of our products, please check our product specification sheets. For details of each product (characteristics graph, reliability information, precautions for use, and so on), see our website (<http://www.ty-top.com/>).

Part number 1	Part number 2	Rated voltage [V]	Temperature characteristics	Capacitance [F]	Capacitance tolerance	Q (at 1MHz) min	HTLT		Thickness ^{*3} [mm]	Soldering R:Reflow W:Wave
							Rated voltage x %			
EMK042 CG2R4□D-W		16	CG COG	2.4 p	±0.05pF, ±0.1pF, ±0.25pF	448	200		0.2±0.02	R
EMK042 CG2R5□D-W			CG COG	2.5 p	±0.05pF, ±0.1pF, ±0.25pF	450	200		0.2±0.02	R
EMK042 CG2R6□D-W			CG COG	2.6 p	±0.05pF, ±0.1pF, ±0.25pF	452	200		0.2±0.02	R
EMK042 CG2R7□D-W			CG COG	2.7 p	±0.05pF, ±0.1pF, ±0.25pF	454	200		0.2±0.02	R
EMK042 CG2R8□D-W			CG COG	2.8 p	±0.05pF, ±0.1pF, ±0.25pF	456	200		0.2±0.02	R
EMK042 CG2R9□D-W			CG COG	2.9 p	±0.05pF, ±0.1pF, ±0.25pF	458	200		0.2±0.02	R
EMK042 CG030□D-W			CG COG	3 p	±0.05pF, ±0.1pF, ±0.25pF	460	200		0.2±0.02	R
EMK042 CG3R1□D-W			CG COG	3.1 p	±0.1pF, ±0.25pF	462	200		0.2±0.02	R
EMK042 CG3R2□D-W			CG COG	3.2 p	±0.1pF, ±0.25pF	464	200		0.2±0.02	R
EMK042 CG3R3□D-W			CG COG	3.3 p	±0.1pF, ±0.25pF	466	200		0.2±0.02	R
EMK042 CG3R4□D-W			CG COG	3.4 p	±0.1pF, ±0.25pF	468	200		0.2±0.02	R
EMK042 CG3R5□D-W			CG COG	3.5 p	±0.1pF, ±0.25pF	470	200		0.2±0.02	R
EMK042 CG3R6□D-W			CG COG	3.6 p	±0.1pF, ±0.25pF	472	200		0.2±0.02	R
EMK042 CG3R7□D-W			CG COG	3.7 p	±0.1pF, ±0.25pF	474	200		0.2±0.02	R
EMK042 CG3R8□D-W			CG COG	3.8 p	±0.1pF, ±0.25pF	476	200		0.2±0.02	R
EMK042 CG3R9□D-W			CG COG	3.9 p	±0.1pF, ±0.25pF	478	200		0.2±0.02	R
EMK042 CG040□D-W			CG COG	4 p	±0.1pF, ±0.25pF	480	200		0.2±0.02	R
EMK042 CG4R1□D-W			CG COG	4.1 p	±0.1pF, ±0.25pF	482	200		0.2±0.02	R
EMK042 CG4R2□D-W			CG COG	4.2 p	±0.1pF, ±0.25pF	484	200		0.2±0.02	R
EMK042 CG4R3□D-W			CG COG	4.3 p	±0.1pF, ±0.25pF	486	200		0.2±0.02	R
EMK042 CG4R4□D-W			CG COG	4.4 p	±0.1pF, ±0.25pF	488	200		0.2±0.02	R
EMK042 CG4R5□D-W			CG COG	4.5 p	±0.1pF, ±0.25pF	490	200		0.2±0.02	R
EMK042 CG4R6□D-W			CG COG	4.6 p	±0.1pF, ±0.25pF	492	200		0.2±0.02	R
EMK042 CG4R7□D-W			CG COG	4.7 p	±0.1pF, ±0.25pF	494	200		0.2±0.02	R
EMK042 CG4R8□D-W			CG COG	4.8 p	±0.1pF, ±0.25pF	496	200		0.2±0.02	R
EMK042 CG4R9□D-W			CG COG	4.9 p	±0.1pF, ±0.25pF	498	200		0.2±0.02	R
EMK042 CG050□D-W			CG COG	5 p	±0.1pF, ±0.25pF	500	200		0.2±0.02	R
EMK042 CG5R1□D-W			CG COG	5.1 p	±0.1pF, ±0.25pF, ±0.5pF	502	200		0.2±0.02	R
EMK042 CG5R2□D-W			CG COG	5.2 p	±0.1pF, ±0.25pF, ±0.5pF	504	200		0.2±0.02	R
EMK042 CG5R3□D-W			CG COG	5.3 p	±0.1pF, ±0.25pF, ±0.5pF	506	200		0.2±0.02	R
EMK042 CG5R4□D-W			CG COG	5.4 p	±0.1pF, ±0.25pF, ±0.5pF	508	200		0.2±0.02	R
EMK042 CG5R5□D-W			CG COG	5.5 p	±0.1pF, ±0.25pF, ±0.5pF	510	200		0.2±0.02	R
EMK042 CG5R6□D-W			CG COG	5.6 p	±0.1pF, ±0.25pF, ±0.5pF	512	200		0.2±0.02	R
EMK042 CG5R7□D-W			CG COG	5.7 p	±0.1pF, ±0.25pF, ±0.5pF	514	200		0.2±0.02	R
EMK042 CG5R8□D-W			CG COG	5.8 p	±0.1pF, ±0.25pF, ±0.5pF	516	200		0.2±0.02	R
EMK042 CG5R9□D-W			CG COG	5.9 p	±0.1pF, ±0.25pF, ±0.5pF	518	200		0.2±0.02	R
EMK042 CG060□D-W			CG COG	6 p	±0.1pF, ±0.25pF, ±0.5pF	520	200		0.2±0.02	R
EMK042 CG6R1□D-W			CG COG	6.1 p	±0.1pF, ±0.25pF, ±0.5pF	522	200		0.2±0.02	R
EMK042 CG6R2□D-W			CG COG	6.2 p	±0.1pF, ±0.25pF, ±0.5pF	524	200		0.2±0.02	R
EMK042 CG6R3□D-W			CG COG	6.3 p	±0.1pF, ±0.25pF, ±0.5pF	526	200		0.2±0.02	R
EMK042 CG6R4□D-W			CG COG	6.4 p	±0.1pF, ±0.25pF, ±0.5pF	528	200		0.2±0.02	R
EMK042 CG6R5□D-W			CG COG	6.5 p	±0.1pF, ±0.25pF, ±0.5pF	530	200		0.2±0.02	R
EMK042 CG6R6□D-W			CG COG	6.6 p	±0.1pF, ±0.25pF, ±0.5pF	532	200		0.2±0.02	R
EMK042 CG6R7□D-W			CG COG	6.7 p	±0.1pF, ±0.25pF, ±0.5pF	534	200		0.2±0.02	R
EMK042 CG6R8□D-W			CG COG	6.8 p	±0.1pF, ±0.25pF, ±0.5pF	536	200		0.2±0.02	R
EMK042 CG6R9□D-W			CG COG	6.9 p	±0.1pF, ±0.25pF, ±0.5pF	538	200		0.2±0.02	R
EMK042 CG070□D-W			CG COG	7 p	±0.1pF, ±0.25pF, ±0.5pF	540	200		0.2±0.02	R
EMK042 CG7R1□D-W			CG COG	7.1 p	±0.1pF, ±0.25pF, ±0.5pF	542	200		0.2±0.02	R
EMK042 CG7R2□D-W			CG COG	7.2 p	±0.1pF, ±0.25pF, ±0.5pF	544	200		0.2±0.02	R
EMK042 CG7R3□D-W			CG COG	7.3 p	±0.1pF, ±0.25pF, ±0.5pF	546	200		0.2±0.02	R
EMK042 CG7R4□D-W			CG COG	7.4 p	±0.1pF, ±0.25pF, ±0.5pF	548	200		0.2±0.02	R
EMK042 CG7R5□D-W			CG COG	7.5 p	±0.1pF, ±0.25pF, ±0.5pF	550	200		0.2±0.02	R
EMK042 CG7R6□D-W			CG COG	7.6 p	±0.1pF, ±0.25pF, ±0.5pF	552	200		0.2±0.02	R
EMK042 CG7R7□D-W			CG COG	7.7 p	±0.1pF, ±0.25pF, ±0.5pF	554	200		0.2±0.02	R
EMK042 CG7R8□D-W			CG COG	7.8 p	±0.1pF, ±0.25pF, ±0.5pF	556	200		0.2±0.02	R
EMK042 CG7R9□D-W			CG COG	7.9 p	±0.1pF, ±0.25pF, ±0.5pF	558	200		0.2±0.02	R
EMK042 CG080□D-W			CG COG	8 p	±0.1pF, ±0.25pF, ±0.5pF	560	200		0.2±0.02	R
EMK042 CG8R1□D-W			CG COG	8.1 p	±0.1pF, ±0.25pF, ±0.5pF	562	200		0.2±0.02	R
EMK042 CG8R2□D-W			CG COG	8.2 p	±0.1pF, ±0.25pF, ±0.5pF	564	200		0.2±0.02	R
EMK042 CG8R3□D-W			CG COG	8.3 p	±0.1pF, ±0.25pF, ±0.5pF	566	200		0.2±0.02	R
EMK042 CG8R4□D-W			CG COG	8.4 p	±0.1pF, ±0.25pF, ±0.5pF	568	200		0.2±0.02	R
EMK042 CG8R5□D-W			CG COG	8.5 p	±0.1pF, ±0.25pF, ±0.5pF	570	200		0.2±0.02	R
EMK042 CG8R6□D-W			CG COG	8.6 p	±0.1pF, ±0.25pF, ±0.5pF	572	200		0.2±0.02	R
EMK042 CG8R7□D-W			CG COG	8.7 p	±0.1pF, ±0.25pF, ±0.5pF	574	200		0.2±0.02	R
EMK042 CG8R8□D-W			CG COG	8.8 p	±0.1pF, ±0.25pF, ±0.5pF	576	200		0.2±0.02	R
EMK042 CG8R9□D-W			CG COG	8.9 p	±0.1pF, ±0.25pF, ±0.5pF	578	200		0.2±0.02	R
EMK042 CG090□D-W			CG COG	9 p	±0.1pF, ±0.25pF, ±0.5pF	580	200		0.2±0.02	R
EMK042 CG9R1□D-W			CG COG	9.1 p	±0.1pF, ±0.25pF, ±0.5pF	582	200		0.2±0.02	R
EMK042 CG9R2□D-W			CG COG	9.2 p	±0.1pF, ±0.25pF, ±0.5pF	584	200		0.2±0.02	R
EMK042 CG9R3□D-W			CG COG	9.3 p	±0.1pF, ±0.25pF, ±0.5pF	586	200		0.2±0.02	R
EMK042 CG9R4□D-W			CG COG	9.4 p	±0.1pF, ±0.25pF, ±0.5pF	588	200		0.2±0.02	R
EMK042 CG9R5□D-W			CG COG	9.5 p	±0.1pF, ±0.25pF, ±0.5pF	590	200		0.2±0.02	R
EMK042 CG9R6□D-W			CG COG	9.6 p	±0.1pF, ±0.25pF, ±0.5pF	592	200		0.2±0.02	R
EMK042 CG9R7□D-W			CG COG	9.7 p	±0.1pF, ±0.25pF, ±0.5pF	594	200		0.2±0.02	R
EMK042 CG9R8□D-W			CG COG	9.8 p	±0.1pF, ±0.25pF, ±0.5pF	596	200		0.2±0.02	R
EMK042 CG9R9□D-W			CG COG	9.9 p	±0.1pF, ±0.25pF, ±0.5pF	598	200		0.2±0.02	R
EMK042 CG100DD-W			CG COG	10 p	±0.5pF	600	200		0.2±0.02	R
EMK042 CG110JD-W			CG COG	11 p	±5%	620	200		0.2±0.02	R
EMK042 CG120JD-W			CG COG	12 p	±5%	640	200		0.2±0.02	R
EMK042 CG130JD-W			CG COG	13 p	±5%	660	200		0.2±0.02	R
EMK042 CG150JD-W			CG COG	15 p	±5%	700	200		0.2±0.02	R
EMK042 CG160JC-W			CG COG	16 p	±5%	720	200		0.2±0.02	R
EMK042 CG180JC-W			CG COG	18 p	±5%	760	200		0.2±0.02	R
EMK042 CG200JC-W			CG COG	20 p	±5%	800	200		0.2±0.02	R
EMK042 CG220JC-W			CG COG	22 p	±5%	840	200		0.2±0.02	R
EMK042 CG240JC-W			CG COG	24 p	±5%	880	200		0.2±0.02	R
EMK042 CG270JC-W			CG COG	27 p	±5%	940	200		0.2±0.02	R
EMK042 CG300JC-W			CG COG	30 p	±5%	1000	200		0.2±0.02	R
EMK042 CG330JC-W			CG COG	33 p	±5%	1000	200		0.2±0.02	R
EMK042 CG360JC-W			CG COG	36 p	±5%	1000	200		0.2±0.02	R

▶ This catalog contains the typical specification only due to the limitation of space. When you consider the purchase of our products, please check our product specification sheets. For details of each product (characteristics graph, reliability information, precautions for use, and so on), see our website (<http://www.ty-top.com/>).

■ PARTS NUMBER

Part number 1	Part number 2	Rated voltage [V]	Temperature characteristics		Capacitance [F]	Capacitance tolerance	Q (at 1MHz) min	HTLT	Thickness*3 [mm]	Soldering R:Reflow W:Wave	
								Rated voltage x %			
EMK042	CG390JC-W	16	CG	C0G	39 p	±5%	1000	200	0.2±0.02	R	
EMK042	CG430JC-W		CG	C0G	43 p	±5%	1000	200	0.2±0.02	R	
EMK042	CG470JC-W		CG	C0G	47 p	±5%	1000	200	0.2±0.02	R	
EMK042	CG510JC-W		CG	C0G	51 p	±5%	1000	200	0.2±0.02	R	
EMK042	CG560JC-W		CG	C0G	56 p	±5%	1000	200	0.2±0.02	R	
EMK042	CG620JC-W		CG	C0G	62 p	±5%	1000	200	0.2±0.02	R	
EMK042	CG680JC-W		CG	C0G	68 p	±5%	1000	200	0.2±0.02	R	
EMK042	CG750JC-W		CG	C0G	75 p	±5%	1000	200	0.2±0.02	R	
EMK042	CG820JC-W		CG	C0G	82 p	±5%	1000	200	0.2±0.02	R	
EMK042	CG910JC-W		CG	C0G	91 p	±5%	1000	200	0.2±0.02	R	
EMK042	CG101JC-W		CG	C0G	100 p	±5%	1000	200	0.2±0.02	R	
EMK042	CG221JC-W		CG	C0G	220 p	±5%	1000	200	0.2±0.02	R	
LMK042	CG221JC-W		10	CG	C0G	220 p	±5%	1000	200	0.2±0.02	R

● 063TYPE

[Temperature Characteristic CG : CG/C0G] 0.3mm thickness (T)

Part number 1	Part number 2	Rated voltage [V]	Temperature characteristics		Capacitance [F]	Capacitance tolerance	Q (at 1MHz) min	HTLT	Thickness*3 [mm]	Soldering R:Reflow W:Wave
								Rated voltage x %		
UMK063	CG0R2[T-F]	50	CG	C0G	0.2 p	±0.1pF, ±0.25pF	404	200	0.3±0.03	R
UMK063	CG0R3[T-F]		CG	C0G	0.3 p	±0.1pF, ±0.25pF	406	200	0.3±0.03	R
UMK063	CG0R4[T-F]		CG	C0G	0.4 p	±0.1pF, ±0.25pF	408	200	0.3±0.03	R
UMK063	CG0R5[T-F]		CG	C0G	0.5 p	±0.1pF, ±0.25pF	410	200	0.3±0.03	R
UMK063	CG0R6[T-F]		CG	C0G	0.6 p	±0.1pF, ±0.25pF	412	200	0.3±0.03	R
UMK063	CG0R7[T-F]		CG	C0G	0.7 p	±0.1pF, ±0.25pF	414	200	0.3±0.03	R
UMK063	CGR75[T-F]		CG	C0G	0.75 p	±0.1pF, ±0.25pF	415	200	0.3±0.03	R
UMK063	CG0R8[T-F]		CG	C0G	0.8 p	±0.1pF, ±0.25pF	416	200	0.3±0.03	R
UMK063	CG0R9[T-F]		CG	C0G	0.9 p	±0.1pF, ±0.25pF	418	200	0.3±0.03	R
UMK063	CG010[T-F]		CG	C0G	1 p	±0.1pF, ±0.25pF	420	200	0.3±0.03	R
UMK063	CG1R1[T-F]		CG	C0G	1.1 p	±0.1pF, ±0.25pF	422	200	0.3±0.03	R
UMK063	CG1R2[T-F]		CG	C0G	1.2 p	±0.1pF, ±0.25pF	424	200	0.3±0.03	R
UMK063	CG1R3[T-F]		CG	C0G	1.3 p	±0.1pF, ±0.25pF	426	200	0.3±0.03	R
UMK063	CG1R4[T-F]		CG	C0G	1.4 p	±0.1pF, ±0.25pF	428	200	0.3±0.03	R
UMK063	CG1R5[T-F]		CG	C0G	1.5 p	±0.1pF, ±0.25pF	430	200	0.3±0.03	R
UMK063	CG1R6[T-F]		CG	C0G	1.6 p	±0.1pF, ±0.25pF	432	200	0.3±0.03	R
UMK063	CG1R7[T-F]		CG	C0G	1.7 p	±0.1pF, ±0.25pF	434	200	0.3±0.03	R
UMK063	CG1R8[T-F]		CG	C0G	1.8 p	±0.1pF, ±0.25pF	436	200	0.3±0.03	R
UMK063	CG1R9[T-F]		CG	C0G	1.9 p	±0.1pF, ±0.25pF	438	200	0.3±0.03	R
UMK063	CG020[T-F]		CG	C0G	2 p	±0.1pF, ±0.25pF	440	200	0.3±0.03	R
UMK063	CG2R1[T-F]		CG	C0G	2.1 p	±0.1pF, ±0.25pF	442	200	0.3±0.03	R
UMK063	CG2R2[T-F]		CG	C0G	2.2 p	±0.1pF, ±0.25pF	444	200	0.3±0.03	R
UMK063	CG2R3[T-F]		CG	C0G	2.3 p	±0.1pF, ±0.25pF	446	200	0.3±0.03	R
UMK063	CG2R4[T-F]		CG	C0G	2.4 p	±0.1pF, ±0.25pF	448	200	0.3±0.03	R
UMK063	CG2R5[T-F]		CG	C0G	2.5 p	±0.1pF, ±0.25pF	450	200	0.3±0.03	R
UMK063	CG2R6[T-F]		CG	C0G	2.6 p	±0.1pF, ±0.25pF	452	200	0.3±0.03	R
UMK063	CG2R7[T-F]		CG	C0G	2.7 p	±0.1pF, ±0.25pF	454	200	0.3±0.03	R
UMK063	CG2R8[T-F]		CG	C0G	2.8 p	±0.1pF, ±0.25pF	456	200	0.3±0.03	R
UMK063	CG2R9[T-F]		CG	C0G	2.9 p	±0.1pF, ±0.25pF	458	200	0.3±0.03	R
UMK063	CG030[T-F]		CG	C0G	3 p	±0.1pF, ±0.25pF	460	200	0.3±0.03	R
UMK063	CG3R1[T-F]		CG	C0G	3.1 p	±0.1pF, ±0.25pF	462	200	0.3±0.03	R
UMK063	CG3R2[T-F]		CG	C0G	3.2 p	±0.1pF, ±0.25pF	464	200	0.3±0.03	R
UMK063	CG3R3[T-F]		CG	C0G	3.3 p	±0.1pF, ±0.25pF	466	200	0.3±0.03	R
UMK063	CG3R4[T-F]		CG	C0G	3.4 p	±0.1pF, ±0.25pF	468	200	0.3±0.03	R
UMK063	CG3R5[T-F]		CG	C0G	3.5 p	±0.1pF, ±0.25pF	470	200	0.3±0.03	R
UMK063	CG3R6[T-F]		CG	C0G	3.6 p	±0.1pF, ±0.25pF	472	200	0.3±0.03	R
UMK063	CG3R7[T-F]		CG	C0G	3.7 p	±0.1pF, ±0.25pF	474	200	0.3±0.03	R
UMK063	CG3R8[T-F]		CG	C0G	3.8 p	±0.1pF, ±0.25pF	476	200	0.3±0.03	R
UMK063	CG3R9[T-F]		CG	C0G	3.9 p	±0.1pF, ±0.25pF	478	200	0.3±0.03	R
UMK063	CG040[T-F]		CG	C0G	4 p	±0.1pF, ±0.25pF	480	200	0.3±0.03	R
UMK063	CG4R1[T-F]		CG	C0G	4.1 p	±0.1pF, ±0.25pF	482	200	0.3±0.03	R
UMK063	CG4R2[T-F]		CG	C0G	4.2 p	±0.1pF, ±0.25pF	484	200	0.3±0.03	R
UMK063	CG4R3[T-F]		CG	C0G	4.3 p	±0.1pF, ±0.25pF	486	200	0.3±0.03	R
UMK063	CG4R4[T-F]		CG	C0G	4.4 p	±0.1pF, ±0.25pF	488	200	0.3±0.03	R
UMK063	CG4R5[T-F]		CG	C0G	4.5 p	±0.1pF, ±0.25pF	490	200	0.3±0.03	R
UMK063	CG4R6[T-F]		CG	C0G	4.6 p	±0.1pF, ±0.25pF	492	200	0.3±0.03	R
UMK063	CG4R7[T-F]		CG	C0G	4.7 p	±0.1pF, ±0.25pF	494	200	0.3±0.03	R
UMK063	CG4R8[T-F]		CG	C0G	4.8 p	±0.1pF, ±0.25pF	496	200	0.3±0.03	R
UMK063	CG4R9[T-F]		CG	C0G	4.9 p	±0.1pF, ±0.25pF	498	200	0.3±0.03	R
UMK063	CG050[T-F]		CG	C0G	5 p	±0.1pF, ±0.25pF	500	200	0.3±0.03	R
UMK063	CG5R1[T-F]	CG	C0G	5.1 p	±0.1pF, ±0.25pF, ±0.5pF	502	200	0.3±0.03	R	
UMK063	CG5R2[T-F]	CG	C0G	5.2 p	±0.1pF, ±0.25pF, ±0.5pF	504	200	0.3±0.03	R	
UMK063	CG5R3[T-F]	CG	C0G	5.3 p	±0.1pF, ±0.25pF, ±0.5pF	506	200	0.3±0.03	R	
UMK063	CG5R4[T-F]	CG	C0G	5.4 p	±0.1pF, ±0.25pF, ±0.5pF	508	200	0.3±0.03	R	
UMK063	CG5R5[T-F]	CG	C0G	5.5 p	±0.1pF, ±0.25pF, ±0.5pF	510	200	0.3±0.03	R	
UMK063	CG5R6[T-F]	CG	C0G	5.6 p	±0.1pF, ±0.25pF, ±0.5pF	512	200	0.3±0.03	R	
UMK063	CG5R7[T-F]	CG	C0G	5.7 p	±0.1pF, ±0.25pF, ±0.5pF	514	200	0.3±0.03	R	
UMK063	CG5R8[T-F]	CG	C0G	5.8 p	±0.1pF, ±0.25pF, ±0.5pF	516	200	0.3±0.03	R	
UMK063	CG5R9[T-F]	CG	C0G	5.9 p	±0.1pF, ±0.25pF, ±0.5pF	518	200	0.3±0.03	R	
UMK063	CG060[T-F]	CG	C0G	6 p	±0.1pF, ±0.25pF, ±0.5pF	520	200	0.3±0.03	R	
UMK063	CG6R1[T-F]	CG	C0G	6.1 p	±0.1pF, ±0.25pF, ±0.5pF	522	200	0.3±0.03	R	
UMK063	CG6R2[T-F]	CG	C0G	6.2 p	±0.1pF, ±0.25pF, ±0.5pF	524	200	0.3±0.03	R	
UMK063	CG6R3[T-F]	CG	C0G	6.3 p	±0.1pF, ±0.25pF, ±0.5pF	526	200	0.3±0.03	R	
UMK063	CG6R4[T-F]	CG	C0G	6.4 p	±0.1pF, ±0.25pF, ±0.5pF	528	200	0.3±0.03	R	
UMK063	CG6R5[T-F]	CG	C0G	6.5 p	±0.1pF, ±0.25pF, ±0.5pF	530	200	0.3±0.03	R	
UMK063	CG6R6[T-F]	CG	C0G	6.6 p	±0.1pF, ±0.25pF, ±0.5pF	532	200	0.3±0.03	R	
UMK063	CG6R7[T-F]	CG	C0G	6.7 p	±0.1pF, ±0.25pF, ±0.5pF	534	200	0.3±0.03	R	
UMK063	CG6R8[T-F]	CG	C0G	6.8 p	±0.1pF, ±0.25pF, ±0.5pF	536	200	0.3±0.03	R	
UMK063	CG6R9[T-F]	CG	C0G	6.9 p	±0.1pF, ±0.25pF, ±0.5pF	538	200	0.3±0.03	R	

▶ This catalog contains the typical specification only due to the limitation of space. When you consider the purchase of our products, please check our product specification sheets. For details of each product (characteristics graph, reliability information, precautions for use, and so on), see our website (<http://www.ty-top.com/>).

Part number 1	Part number 2	Rated voltage [V]	Temperature characteristics		Capacitance [F]	Capacitance tolerance	Q (at 1MHz) min	HTLT	Thickness ⁹³ [mm]	Soldering R:Reflow W:Wave
								Rated voltage x %		
UMK063 CG070□T-F		50	CG	COG	7 p	±0.1pF, ±0.25pF, ±0.5pF	540	200	0.3±0.03	R
UMK063 CG7R1□T-F			CG	COG	7.1 p	±0.1pF, ±0.25pF, ±0.5pF	542	200	0.3±0.03	R
UMK063 CG7R2□T-F			CG	COG	7.2 p	±0.1pF, ±0.25pF, ±0.5pF	544	200	0.3±0.03	R
UMK063 CG7R3□T-F			CG	COG	7.3 p	±0.1pF, ±0.25pF, ±0.5pF	546	200	0.3±0.03	R
UMK063 CG7R4□T-F			CG	COG	7.4 p	±0.1pF, ±0.25pF, ±0.5pF	548	200	0.3±0.03	R
UMK063 CG7R5□T-F			CG	COG	7.5 p	±0.1pF, ±0.25pF, ±0.5pF	550	200	0.3±0.03	R
UMK063 CG7R6□T-F			CG	COG	7.6 p	±0.1pF, ±0.25pF, ±0.5pF	552	200	0.3±0.03	R
UMK063 CG7R7□T-F			CG	COG	7.7 p	±0.1pF, ±0.25pF, ±0.5pF	554	200	0.3±0.03	R
UMK063 CG7R8□T-F			CG	COG	7.8 p	±0.1pF, ±0.25pF, ±0.5pF	556	200	0.3±0.03	R
UMK063 CG7R9□T-F			CG	COG	7.9 p	±0.1pF, ±0.25pF, ±0.5pF	558	200	0.3±0.03	R
UMK063 CG080□T-F			CG	COG	8 p	±0.1pF, ±0.25pF, ±0.5pF	560	200	0.3±0.03	R
UMK063 CG8R1□T-F			CG	COG	8.1 p	±0.1pF, ±0.25pF, ±0.5pF	562	200	0.3±0.03	R
UMK063 CG8R2□T-F			CG	COG	8.2 p	±0.1pF, ±0.25pF, ±0.5pF	564	200	0.3±0.03	R
UMK063 CG8R3□T-F			CG	COG	8.3 p	±0.1pF, ±0.25pF, ±0.5pF	566	200	0.3±0.03	R
UMK063 CG8R4□T-F			CG	COG	8.4 p	±0.1pF, ±0.25pF, ±0.5pF	568	200	0.3±0.03	R
UMK063 CG8R5□T-F			CG	COG	8.5 p	±0.1pF, ±0.25pF, ±0.5pF	570	200	0.3±0.03	R
UMK063 CG8R6□T-F			CG	COG	8.6 p	±0.1pF, ±0.25pF, ±0.5pF	572	200	0.3±0.03	R
UMK063 CG8R7□T-F			CG	COG	8.7 p	±0.1pF, ±0.25pF, ±0.5pF	574	200	0.3±0.03	R
UMK063 CG8R8□T-F			CG	COG	8.8 p	±0.1pF, ±0.25pF, ±0.5pF	576	200	0.3±0.03	R
UMK063 CG8R9□T-F			CG	COG	8.9 p	±0.1pF, ±0.25pF, ±0.5pF	578	200	0.3±0.03	R
UMK063 CG090□T-F			CG	COG	9 p	±0.1pF, ±0.25pF, ±0.5pF	580	200	0.3±0.03	R
UMK063 CG9R1□T-F			CG	COG	9.1 p	±0.1pF, ±0.25pF, ±0.5pF	582	200	0.3±0.03	R
UMK063 CG9R2□T-F			CG	COG	9.2 p	±0.1pF, ±0.25pF, ±0.5pF	584	200	0.3±0.03	R
UMK063 CG9R3□T-F			CG	COG	9.3 p	±0.1pF, ±0.25pF, ±0.5pF	586	200	0.3±0.03	R
UMK063 CG9R4□T-F			CG	COG	9.4 p	±0.1pF, ±0.25pF, ±0.5pF	588	200	0.3±0.03	R
UMK063 CG9R5□T-F			CG	COG	9.5 p	±0.1pF, ±0.25pF, ±0.5pF	590	200	0.3±0.03	R
UMK063 CG9R6□T-F			CG	COG	9.6 p	±0.1pF, ±0.25pF, ±0.5pF	592	200	0.3±0.03	R
UMK063 CG9R7□T-F			CG	COG	9.7 p	±0.1pF, ±0.25pF, ±0.5pF	594	200	0.3±0.03	R
UMK063 CG9R8□T-F			CG	COG	9.8 p	±0.1pF, ±0.25pF, ±0.5pF	596	200	0.3±0.03	R
UMK063 CG9R9□T-F			CG	COG	9.9 p	±0.1pF, ±0.25pF, ±0.5pF	598	200	0.3±0.03	R
UMK063 CG100DT-F			CG	COG	10 p	±0.5pF	600	200	0.3±0.03	R
UMK063 CG110JT-F			CG	COG	11 p	±5%	620	200	0.3±0.03	R
UMK063 CG120JT-F			CG	COG	12 p	±5%	640	200	0.3±0.03	R
UMK063 CG130JT-F			CG	COG	13 p	±5%	660	200	0.3±0.03	R
UMK063 CG150JT-F			CG	COG	15 p	±5%	700	200	0.3±0.03	R
UMK063 CG160JT-F			CG	COG	16 p	±5%	720	200	0.3±0.03	R
UMK063 CG180JT-F			CG	COG	18 p	±5%	760	200	0.3±0.03	R
UMK063 CG200JT-F			CG	COG	20 p	±5%	800	200	0.3±0.03	R
UMK063 CG220JT-F			CG	COG	22 p	±5%	840	200	0.3±0.03	R
UMK063 CG240JT-F			CG	COG	24 p	±5%	880	200	0.3±0.03	R
UMK063 CG270JT-F			CG	COG	27 p	±5%	940	200	0.3±0.03	R
UMK063 CG300JT-F			CG	COG	30 p	±5%	1000	200	0.3±0.03	R
UMK063 CG330JT-F			CG	COG	33 p	±5%	1000	200	0.3±0.03	R
UMK063 CG360JT-F			CG	COG	36 p	±5%	1000	200	0.3±0.03	R
UMK063 CG390JT-F			CG	COG	39 p	±5%	1000	200	0.3±0.03	R
UMK063 CG430JT-F			CG	COG	43 p	±5%	1000	200	0.3±0.03	R
UMK063 CG470JT-F			CG	COG	47 p	±5%	1000	200	0.3±0.03	R
UMK063 CG510JT-F			CG	COG	51 p	±5%	1000	200	0.3±0.03	R
UMK063 CG560JT-F			CG	COG	56 p	±5%	1000	200	0.3±0.03	R
UMK063 CG620JT-F			CG	COG	62 p	±5%	1000	200	0.3±0.03	R
UMK063 CG680JT-F		CG	COG	68 p	±5%	1000	200	0.3±0.03	R	
UMK063 CG750JT-F		CG	COG	75 p	±5%	1000	200	0.3±0.03	R	
UMK063 CG820JT-F		CG	COG	82 p	±5%	1000	200	0.3±0.03	R	
UMK063 CG910JT-F		CG	COG	91 p	±5%	1000	200	0.3±0.03	R	
UMK063 CG101JT-F		CG	COG	100 p	±5%	1000	200	0.3±0.03	R	
UMK063 CG111JT-F		CG	COG	110 p	±5%	1000	200	0.3±0.03	R	
UMK063 CG121JT-F		CG	COG	120 p	±5%	1000	200	0.3±0.03	R	
UMK063 CG131JT-F		CG	COG	130 p	±5%	1000	200	0.3±0.03	R	
UMK063 CG151JT-F		CG	COG	150 p	±5%	1000	200	0.3±0.03	R	
UMK063 CG181JT-F		CG	COG	180 p	±5%	1000	200	0.3±0.03	R	
UMK063 CG201JT-F		CG	COG	200 p	±5%	1000	200	0.3±0.03	R	
UMK063 CG221JT-F		CG	COG	220 p	±5%	1000	200	0.3±0.03	R	
TMK063 CG241JT-F		CG	COG	240 p	±5%	1000	200	0.3±0.03	R	
TMK063 CG271JT-F		CG	COG	270 p	±5%	1000	200	0.3±0.03	R	
TMK063 CG301JT-F		CG	COG	300 p	±5%	1000	200	0.3±0.03	R	
TMK063 CG331JT-F		CG	COG	330 p	±5%	1000	200	0.3±0.03	R	
TMK063 CG361JT-F		CG	COG	360 p	±5%	1000	200	0.3±0.03	R	
TMK063 CG391JT-F		CG	COG	390 p	±5%	1000	200	0.3±0.03	R	
TMK063 CG431JT-F		CG	COG	430 p	±5%	1000	200	0.3±0.03	R	
TMK063 CG471JT-F		CG	COG	470 p	±5%	1000	200	0.3±0.03	R	
TMK063 CG511JT-F		CG	COG	510 p	±5%	1000	200	0.3±0.03	R	
TMK063 CG561JT-F		CG	COG	560 p	±5%	1000	200	0.3±0.03	R	
TMK063 CG621JT-F		CG	COG	620 p	±5%	1000	200	0.3±0.03	R	
TMK063 CG681JT-F		CG	COG	680 p	±5%	1000	200	0.3±0.03	R	
TMK063 CG751JT-F		CG	COG	750 p	±5%	1000	200	0.3±0.03	R	
TMK063 CG821JT-F		CG	COG	820 p	±5%	1000	200	0.3±0.03	R	
TMK063 CG911JT-F		CG	COG	910 p	±5%	1000	200	0.3±0.03	R	
TMK063 CG102JT-F		CG	COG	1000 p	±5%	1000	200	0.3±0.03	R	

▶ This catalog contains the typical specification only due to the limitation of space. When you consider the purchase of our products, please check our product specification sheets. For details of each product (characteristics graph, reliability information, precautions for use, and so on), see our website (<http://www.ty-top.com/>).

105TYPE

【Temperature Characteristic CG : CG/C0G】 0.5mm thickness (V)

Part number 1	Part number 2	Rated voltage [V]	Temperature characteristics		Capacitance [F]	Capacitance tolerance	Q (at 1MHz) min	HTLT	Thickness*3 [mm]	Soldering R:Reflow W:Wave
								Rated voltage x %		
UMK105 CG0R5CV-F		50	CG	C0G	0.5 p	±0.25pF	410	200	0.5±0.05	R
UMK105 CG010CV-F			CG	C0G	1 p	±0.25pF	420	200	0.5±0.05	R
UMK105 CG1R5CV-F			CG	C0G	1.5 p	±0.25pF	430	200	0.5±0.05	R
UMK105 CG020CV-F			CG	C0G	2 p	±0.25pF	440	200	0.5±0.05	R
UMK105 CG030CV-F			CG	C0G	3 p	±0.25pF	460	200	0.5±0.05	R
UMK105 CG040CV-F			CG	C0G	4 p	±0.25pF	480	200	0.5±0.05	R
UMK105 CG050CV-F			CG	C0G	5 p	±0.25pF	500	200	0.5±0.05	R
UMK105 CG060DV-F			CG	C0G	6 p	±0.5pF	520	200	0.5±0.05	R
UMK105 CG070DV-F			CG	C0G	7 p	±0.5pF	540	200	0.5±0.05	R
UMK105 CG080DV-F			CG	C0G	8 p	±0.5pF	560	200	0.5±0.05	R
UMK105 CG090DV-F			CG	C0G	9 p	±0.5pF	580	200	0.5±0.05	R
UMK105 CG100DV-F			CG	C0G	10 p	±0.5pF	600	200	0.5±0.05	R
UMK105 CG120JV-F			CG	C0G	12 p	±5%	640	200	0.5±0.05	R
UMK105 CG150JV-F			CG	C0G	15 p	±5%	700	200	0.5±0.05	R
UMK105 CG180JV-F			CG	C0G	18 p	±5%	760	200	0.5±0.05	R
UMK105 CG220JV-F			CG	C0G	22 p	±5%	840	200	0.5±0.05	R
UMK105 CG270JV-F			CG	C0G	27 p	±5%	940	200	0.5±0.05	R
UMK105 CG330JV-F			CG	C0G	33 p	±5%	1000	200	0.5±0.05	R
UMK105 CG390JV-F			CG	C0G	39 p	±5%	1000	200	0.5±0.05	R
UMK105 CG470JV-F			CG	C0G	47 p	±5%	1000	200	0.5±0.05	R
UMK105 CG560JV-F			CG	C0G	56 p	±5%	1000	200	0.5±0.05	R
UMK105 CG680JV-F			CG	C0G	68 p	±5%	1000	200	0.5±0.05	R
UMK105 CG820JV-F			CG	C0G	82 p	±5%	1000	200	0.5±0.05	R
UMK105 CG101JV-F			CG	C0G	100 p	±5%	1000	200	0.5±0.05	R
UMK105 CG121JV-F			CG	C0G	120 p	±5%	1000	200	0.5±0.05	R
UMK105 CG151JV-F			CG	C0G	150 p	±5%	1000	200	0.5±0.05	R
UMK105 CG181JV-F			CG	C0G	180 p	±5%	1000	200	0.5±0.05	R
UMK105 CG221JV-F			CG	C0G	220 p	±5%	1000	200	0.5±0.05	R
UMK105 CG271JV-F			CG	C0G	270 p	±5%	1000	200	0.5±0.05	R
UMK105 CG331JV-F			CG	C0G	330 p	±5%	1000	200	0.5±0.05	R
UMK105 CG391JV-F			CG	C0G	390 p	±5%	1000	200	0.5±0.05	R
UMK105 CG471JV-F			CG	C0G	470 p	±5%	1000	200	0.5±0.05	R
UMK105 CG561JV-F			CG	C0G	560 p	±5%	1000	200	0.5±0.05	R
UMK105 CG681JV-F			CG	C0G	680 p	±5%	1000	200	0.5±0.05	R
UMK105 CG821JV-F			CG	C0G	820 p	±5%	1000	200	0.5±0.05	R
UMK105 CG102JV-F			CG	C0G	1000 p	±5%	1000	200	0.5±0.05	R

【Temperature Characteristic UΔ : UΔ/U2Δ】 0.5mm thickness (V)

Part number 1	Part number 2	Rated voltage [V]	Temperature characteristics		Capacitance [F]	Capacitance tolerance	Q (at 1MHz) min	HTLT	Thickness*3 [mm]	Soldering R:Reflow W:Wave
								Rated voltage x %		
UMK105 UK0R5CV-F		50	UK	U2K	0.5 p	±0.25pF	410	200	0.5±0.05	R
UMK105 UK010CV-F			UK	U2K	1 p	±0.25pF	420	200	0.5±0.05	R
UMK105 UK1R5CV-F			UK	U2K	1.5 p	±0.25pF	430	200	0.5±0.05	R
UMK105 UK020CV-F			UK	U2K	2 p	±0.25pF	440	200	0.5±0.05	R
UMK105 UK030CV-F			UK	U2K	3 p	±0.25pF	460	200	0.5±0.05	R
UMK105 UJ040CV-F			UJ	U2J	4 p	±0.25pF	480	200	0.5±0.05	R
UMK105 UJ050CV-F			UJ	U2J	5 p	±0.25pF	500	200	0.5±0.05	R
UMK105 UJ060DV-F			UJ	U2J	6 p	±0.5pF	520	200	0.5±0.05	R
UMK105 UJ070DV-F			UJ	U2J	7 p	±0.5pF	540	200	0.5±0.05	R
UMK105 UJ080DV-F			UJ	U2J	8 p	±0.5pF	560	200	0.5±0.05	R
UMK105 UJ090DV-F			UJ	U2J	9 p	±0.5pF	580	200	0.5±0.05	R
UMK105 UJ100DV-F			UJ	U2J	10 p	±0.5pF	600	200	0.5±0.05	R
UMK105 UJ120JV-F			UJ	U2J	12 p	±5%	640	200	0.5±0.05	R
UMK105 UJ150JV-F			UJ	U2J	15 p	±5%	700	200	0.5±0.05	R
UMK105 UJ180JV-F			UJ	U2J	18 p	±5%	760	200	0.5±0.05	R
UMK105 UJ220JV-F			UJ	U2J	22 p	±5%	840	200	0.5±0.05	R
UMK105 UJ270JV-F			UJ	U2J	27 p	±5%	940	200	0.5±0.05	R
UMK105 UJ330JV-F			UJ	U2J	33 p	±5%	1000	200	0.5±0.05	R
UMK105 UJ390JV-F			UJ	U2J	39 p	±5%	1000	200	0.5±0.05	R
UMK105 UJ470JV-F			UJ	U2J	47 p	±5%	1000	200	0.5±0.05	R
UMK105 UJ560JV-F			UJ	U2J	56 p	±5%	1000	200	0.5±0.05	R
UMK105 UJ680JV-F			UJ	U2J	68 p	±5%	1000	200	0.5±0.05	R
UMK105 UJ820JV-F			UJ	U2J	82 p	±5%	1000	200	0.5±0.05	R
UMK105 UJ101JV-F			UJ	U2J	100 p	±5%	1000	200	0.5±0.05	R
UMK105 UJ121JV-F			UJ	U2J	120 p	±5%	1000	200	0.5±0.05	R
UMK105 UJ151JV-F			UJ	U2J	150 p	±5%	1000	200	0.5±0.05	R
UMK105 UJ181JV-F			UJ	U2J	180 p	±5%	1000	200	0.5±0.05	R
UMK105 UJ221JV-F			UJ	U2J	220 p	±5%	1000	200	0.5±0.05	R
UMK105 UJ271JV-F			UJ	U2J	270 p	±5%	1000	200	0.5±0.05	R
UMK105 UJ331JV-F			UJ	U2J	330 p	±5%	1000	200	0.5±0.05	R

【Temperature Characteristic SL】 0.5mm thickness (V)

Part number 1	Part number 2	Rated voltage [V]	Temperature characteristics		Capacitance [F]	Capacitance tolerance	Q (at 1MHz) min	HTLT	Thickness*3 [mm]	Soldering R:Reflow W:Wave
								Rated voltage x %		
UMK105 SL121JV-F		50	SL		120 p	±5%	1000	200	0.5±0.05	R
UMK105 SL151JV-F			SL		150 p	±5%	1000	200	0.5±0.05	R
UMK105 SL181JV-F			SL		180 p	±5%	1000	200	0.5±0.05	R
UMK105 SL221JV-F			SL		220 p	±5%	1000	200	0.5±0.05	R
UMK105 SL271JV-F			SL		270 p	±5%	1000	200	0.5±0.05	R
UMK105 SL331JV-F			SL		330 p	±5%	1000	200	0.5±0.05	R

Multilayer Ceramic Capacitors

PACKAGING

① Minimum Quantity

● Taped package

Type(EIA)	Thickness		Standard quantity [pcs]	
	mm	code	Paper tape	Embossed tape
<input type="checkbox"/> MK021(008004)	0.125	K	—	50000
<input type="checkbox"/> VS021(008004)				
<input type="checkbox"/> MK042(01005)	0.2	C, D	—	40000
<input type="checkbox"/> VS042(01005)				
<input type="checkbox"/> MK063(0201)	0.3	P, T	15000	—
<input type="checkbox"/> WK105(0204) ※	0.3	P	10000	—
<input type="checkbox"/> MK105(0402) <input type="checkbox"/> MF105(0402)	0.13	H	—	20000
	0.18	E	—	15000
	0.2	C	20000	—
	0.3	P	15000	—
	0.5	V	10000	—
<input type="checkbox"/> VK105(0402)	0.5	W	10000	—
<input type="checkbox"/> MK107(0603)	0.45	K	4000	—
<input type="checkbox"/> WK107(0306) ※				
<input type="checkbox"/> MF107(0603)	0.5	V	—	4000
<input type="checkbox"/> VS107(0603)	0.8	A	4000	—
<input type="checkbox"/> MJ107(0603)	0.7	C	4000	—
<input type="checkbox"/> MK212(0805)	0.85	D	4000	—
<input type="checkbox"/> WK212(0508) ※				
<input type="checkbox"/> MF212(0805)				
<input type="checkbox"/> VS212(0805)	1.25	G	—	3000
<input type="checkbox"/> MJ212(0805)	0.85	D	4000	—
	1.25	G	—	2000
<input type="checkbox"/> MK316(1206) <input type="checkbox"/> MF316(1206)	0.85	D	4000	—
	1.15	F	—	3000
	1.6	L	—	2000
<input type="checkbox"/> MJ316(1206)	1.15	F	—	3000
	1.6	L	—	2000
<input type="checkbox"/> MK325(1210) <input type="checkbox"/> MF325(1210)	0.85	D	—	2000
	1.15	F		
	1.9	N		
	2.0max.	Y		
<input type="checkbox"/> MJ325(1210)	2.5	M	—	1000
	1.9	N	—	2000
	2.5	M	—	500(T), 1000(P)
<input type="checkbox"/> MK432(1812)	2.5	M	—	500

Note : ※ LW Reverse type.

② Taping material

※No bottom tape for pressed carrier tape

● Card board carrier tape

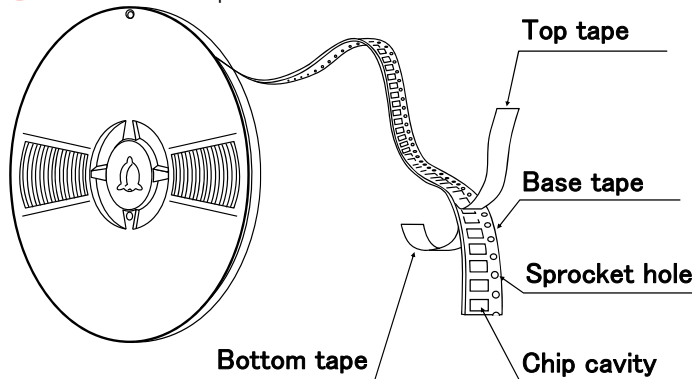

● Embossed tape

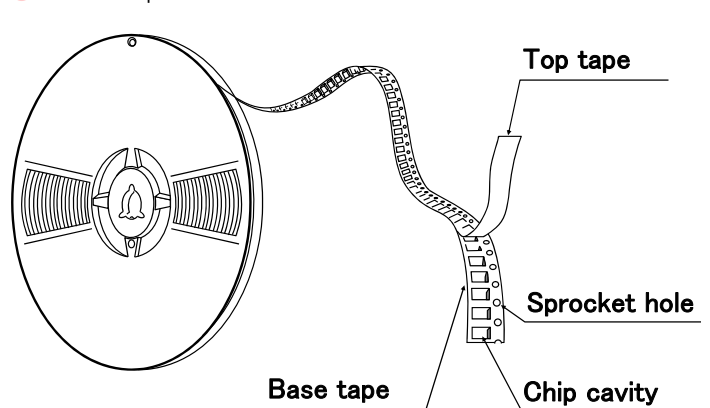

▶ This catalog contains the typical specification only due to the limitation of space. When you consider the purchase of our products, please check our specification. For details of each product (characteristics graph, reliability information, precautions for use, and so on), see our Web site (<http://www.ty-top.com/>).

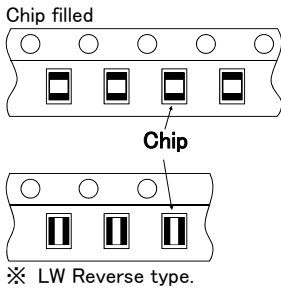

③ Representative taping dimensions

● Paper Tape (8mm wide)

● Pressed carrier tape (2mm pitch)

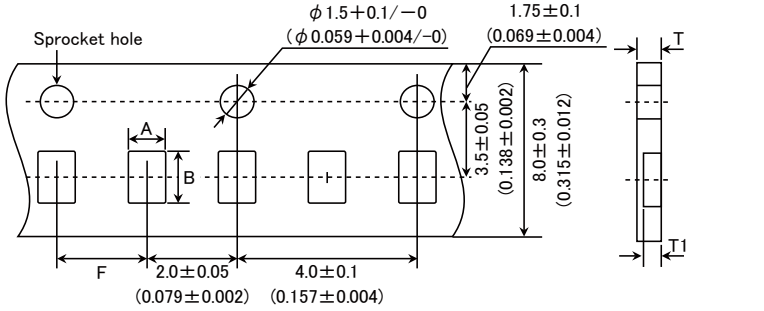

Type(EIA)	Chip Cavity		Insertion Pitch F	Tape Thickness	
	A	B		T	T1
□MK063(0201)	0.37	0.67	2.0±0.05	0.45max.	0.42max.
□WK105(0204) ※	0.65	1.15		0.4max.	0.3max.
□MK105(0402) (*1 C)				0.45max.	0.42max.
□MK105(0402) (*1 P)					

Note *1 Thickness, C: 0.2mm ,P: 0.3mm. ※ LW Reverse type.

Unit: mm

● Punched carrier tape (2mm pitch)

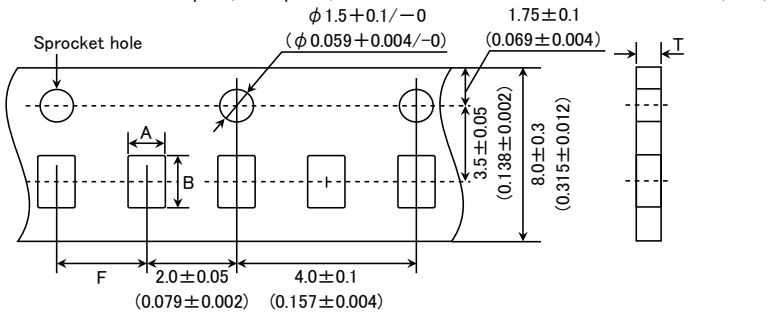

Type(EIA)	Chip Cavity		Insertion Pitch F	Tape Thickness
	A	B		T
□MK105 (0402)	0.65	1.15	2.0±0.05	0.8max.
□MF105 (0402)				
□VK105 (0402)				

Unit: mm

● Punched carrier tape (4mm pitch)

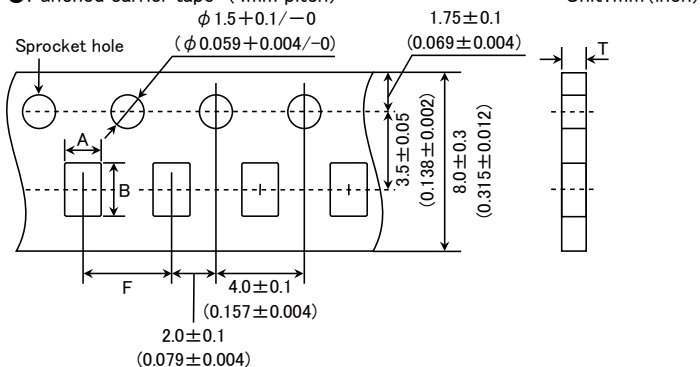

▶ This catalog contains the typical specification only due to the limitation of space. When you consider the purchase of our products, please check our specification. For details of each product (characteristics graph, reliability information, precautions for use, and so on), see our Web site (<http://www.ty-top.com/>).

Type(EIA)	Chip Cavity		Insertion Pitch	Tape Thickness	
	A	B		F	T
□MK107(0603) □WK107(0306) ※ □MF107(0603)	1.0	1.8	4.0±0.1	1.1max.	
□MK212(0805) □WK212(0508) ※	1.65	2.4		1.1max.	
□MK316(1206)	2.0	3.6			

Note: Taping size might be different depending on the size of the product. ※ LW Reverse type.

Unit: mm

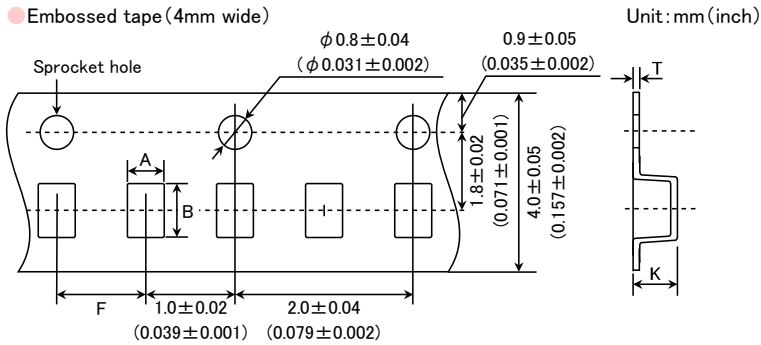

Type(EIA)	Chip Cavity		Insertion Pitch	Tape Thickness	
	A	B		K	T
□MK021(008004) □VS021(008004)	0.135	0.27	1.0±0.02	0.5max.	0.25max.
□MK042(01005) □VS042(01005)					

Unit: mm

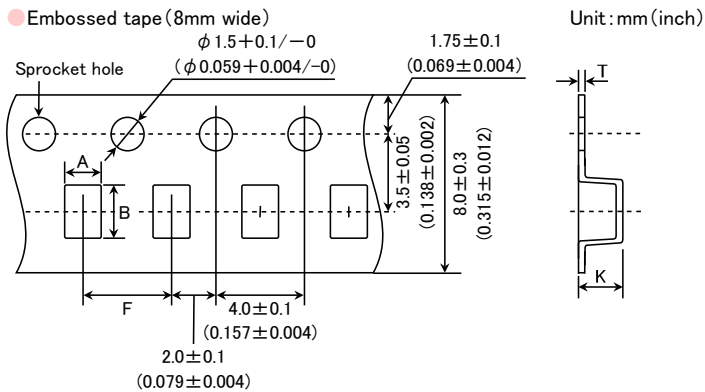

Type(EIA)	Chip Cavity		Insertion Pitch	Tape Thickness	
	A	B		K	T
□MK105(0402)	0.6	1.1	2.0±0.1	0.6max	0.2±0.1
□WK107(0306) ※ □MK212(0805) □MF212(0805)	1.0	1.8	4.0±0.1	1.3max.	0.25±0.1
□MK316(1206) □MF316(1206)	2.0	3.6		3.4max.	0.6max.
□MK325(1210) □MF325(1210)	2.8	3.6			

Note: ※ LW Reverse type.

Unit: mm



Type(EIA)	Chip Cavity		Insertion Pitch	Tape Thickness	
	A	B	F	K	T
□MK325(1210)	3.1	4.0	8.0±0.1	4.0max.	0.6max.
□MK432(1812)	3.7	4.9	8.0±0.1	4.0max.	0.6max.

Unit: mm

④Trailer and Leader



⑤Reel size



A	B	C	D	E	R
$\phi 178 \pm 2.0$	$\phi 50 \text{ min.}$	$\phi 13.0 \pm 0.2$	$\phi 21.0 \pm 0.8$	2.0 ± 0.5	1.0

	T	W
4mm wide tape	1.5max.	5 ± 1.0
8mm wide tape	2.5max.	10 ± 1.5
12mm wide tape	2.5max.	14 ± 1.5

Unit: mm

⑥Top Tape Strength

The top tape requires a peel-off force of 0.1 to 0.7N in the direction of the arrow as illustrated below.

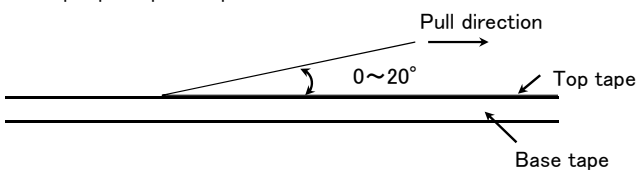

Multilayer Ceramic Capacitors

RELIABILITY DATA

1. Operating Temperature Range

Specified Value	Temperature Compensating(Class1)	Standard	-55 to +125°C		
		High Frequency Type			
Specified Value	High Permittivity (Class2)		Specification	Temperature Range	
		BJ	B	-25 to +85°C	
			X5R	-55 to +85°C	
		B7	X7R	-55 to +125°C	
		C6	X6S	-55 to +105°C	
		C7	X7S	-55 to +125°C	
	LD(※)	X5R	-55 to +85°C		
Note: ※LD Low distortion high value multilayer ceramic capacitor					

2. Storage Conditions

Specified Value	Temperature Compensating(Class1)	Standard	-55 to +125°C		
		High Frequency Type			
Specified Value	High Permittivity (Class2)		Specification	Temperature Range	
		BJ	B	-25 to +85°C	
			X5R	-55 to +85°C	
		B7	X7R	-55 to +125°C	
		C6	X6S	-55 to +105°C	
		C7	X7S	-55 to +125°C	
	LD(※)	X5R	-55 to +85°C		
Note: ※LD Low distortion high value multilayer ceramic capacitor					

3. Rated Voltage

Specified Value	Temperature Compensating(Class1)	Standard	50VDC, 25VDC, 16VDC
		High Frequency Type	50VDC, 25VDC, 16VDC
	High Permittivity (Class2)		50VDC, 35VDC, 25VDC, 16VDC, 10VDC, 6.3VDC, 4VDC, 2.5VDC

4. Withstanding Voltage (Between terminals)

Specified Value	Temperature Compensating(Class1)	Standard	No breakdown or damage	
		High Frequency Type		
Test Methods and Remarks	High Permittivity (Class2)		Class 1	Class 2
			Rated voltage × 3	Rated voltage × 2.5
			1 to 5 sec.	
			50mA max.	

5. Insulation Resistance

Specified Value	Temperature Compensating(Class1)	Standard	10000 MΩ min.
		High Frequency Type	
	High Permittivity (Class2) Note 1		C ≤ 0.047 μF : 10000 MΩ min. C > 0.047 μF : 500MΩ·μF
Test Methods and Remarks	Applied voltage	: Rated voltage	
	Duration	: 60 ± 5 sec.	
	Charge/discharge current	: 50mA max.	

▶ This catalog contains the typical specification only due to the limitation of space. When you consider the purchase of our products, please check our specification. For details of each product (characteristics graph, reliability information, precautions for use, and so on), see our Web site (<http://www.ty-top.com/>).

6. Capacitance (Tolerance)					
Specified Value	Temperature Compensating(Class1)	Standard	C□	0.2pF ≤ C ≤ 5pF : ±0.25pF	
			U□	0.2pF ≤ C ≤ 10pF : ±0.5pF	
	SL	C > 10pF : ±5% or ±10%			
High Permittivity (Class2)	High Frequency Type	CG	0.2pF ≤ C ≤ 2pF	: ±0.1pF	
			C > 2pF	: ±5%	
High Permittivity (Class2)		±10% or ±20%			
Test Methods and Remarks	Class 1		Class 2		
	Standard		High Frequency Type	C ≤ 10 μF	C > 10 μF
	Preconditioning		None		
	Measuring frequency		1MHz ± 10%	1kHz ± 10%	120 ± 10Hz
	Measuring voltage Nte		0.5 to 5Vrms	1 ± 0.2Vrms	0.5 ± 0.1Vrms
Bias application		None			

7. Q or Dissipation Factor						
Specified Value	Temperature Compensating(Class1)	Standard	C < 30pF : Q ≥ 400 + 20C			
			C ≥ 30pF : Q ≥ 1000 (C: Nominal capacitance)			
High Permittivity (Class2) Note 1	High Frequency Type	Refer to detailed specification				
		BJ, B7, C6, C7: 2.5% max.				
Test Methods and Remarks	Class 1		Class 2			
	Standard		High Frequency Type	C ≤ 10 μF	C > 10 μF	
	Preconditioning		None			
	Measuring frequency		1MHz ± 10%	1GHz	1kHz ± 10%	120 ± 10Hz
	Measuring voltage Note 1		0.5 to 5Vrms		1 ± 0.2Vrms	0.5 ± 0.1Vrms
Bias application		None				
High Frequency Type		Measuring equipment : HP4291A				
		Measuring jig : HP16192A				

8. Temperature Characteristic (Without voltage application)							
Specified Value	Temperature Compensating(Class1)	Standard	Temperature Characteristic [ppm/°C]		Tolerance [ppm/°C]		
			C□ : 0	CG	G : ±30		
			U□ : -750	UJ, UK	J : ±120 K : ±250		
High Permittivity (Class2)	High Frequency Type	SL : +350 to -1000	Temperature Characteristic [ppm/°C]		Tolerance [ppm/°C]		
			C□ : 0	CG	G : ±30		
				Specification	Capacitance change	Reference temperature	Temperature Range
Test Methods and Remarks	Class 1	Capacitance at 20°C and 85°C shall be measured in thermal equilibrium, and the temperature characteristic shall be calculated from the following equation.	BJ	B	±10%	20°C	-25 to +85°C
				X5R	±15%	25°C	-55 to +85°C
			B7	X7R	±15%	25°C	-55 to +125°C
			C6	XS	±22%	25°C	-55 to +105°C
			C7	X7S	±22%	25°C	-55 to +125°C
	LD(※)	X5R	±15%	25°C	-55 to +85°C		
Note : ※LD Low distortion high value multilayer ceramic capacitor							
Test Methods and Remarks	Class 2	Capacitance at each step shall be measured in thermal equilibrium, and the temperature characteristic shall be calculated from the following equation.					
			Step	B	X5R, X7R, X6S, X7S		
			1	Minimum operating temperature			
			2	20°C	25°C		
			3	Maximum operating temperature			
		$\frac{(C - C_2)}{C_2} \times 100(\%)$		C : Capacitance in Step 1 or Step 3 C ₂ : Capacitance in Step 2			

▶ This catalog contains the typical specification only due to the limitation of space. When you consider the purchase of our products, please check our specification. For details of each product (characteristics graph, reliability information, precautions for use, and so on), see our Web site (<http://www.ty-top.com/>).

9. Deflection																				
Specified Value	Temperature Compensating(Class1)	Standard	Appearance : No abnormality Capacitance change : Within $\pm 5\%$ or ± 0.5 pF, whichever is larger.																	
		High Frequency Type	Appearance : No abnormality Capacitance change : Within ± 0.5 pF																	
	High Permittivity (Class2)		Appearance : No abnormality Capacitance change : Within $\pm 12.5\%$																	
Test Methods and Remarks	<table border="1"> <thead> <tr> <th rowspan="2"></th> <th colspan="2">Multilayer Ceramic Capacitors</th> </tr> <tr> <th>021, 042, 063, *105 Type</th> <th>The other types</th> </tr> </thead> <tbody> <tr> <td>Board</td> <td colspan="2">Glass epoxy-resin substrate</td> </tr> <tr> <td>Thickness</td> <td>0.8mm</td> <td>1.6mm</td> </tr> <tr> <td>Warp</td> <td colspan="2">1mm</td> </tr> <tr> <td>Duration</td> <td colspan="2">10 sec.</td> </tr> </tbody> </table> <p>*105 Type thickness, C: 0.2mm ,P: 0.3mm.</p>			Multilayer Ceramic Capacitors		021, 042, 063, *105 Type	The other types	Board	Glass epoxy-resin substrate		Thickness	0.8mm	1.6mm	Warp	1mm		Duration	10 sec.		 <p>(Unit: mm) Capacitance measurement shall be conducted with the board bent</p>
		Multilayer Ceramic Capacitors																		
021, 042, 063, *105 Type		The other types																		
Board	Glass epoxy-resin substrate																			
Thickness	0.8mm	1.6mm																		
Warp	1mm																			
Duration	10 sec.																			

10. Body Strength			
Specified Value	Temperature Compensating(Class1)	Standard	—
		High Frequency Type	No mechanical damage.
	High Permittivity (Class2)		—
Test Methods and Remarks	High Frequency 105Type Applied force : 5N Duration : 10 sec.		

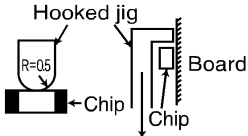
11. Adhesive Strength of Terminal Electrodes														
Specified Value	Temperature Compensating(Class1)	Standard	No terminal separation or its indication.											
		High Frequency Type												
	High Permittivity (Class2)													
Test Methods and Remarks	<table border="1"> <thead> <tr> <th rowspan="2"></th> <th colspan="2">Multilayer Ceramic Capacitors</th> </tr> <tr> <th>021, 042, 063 Type</th> <th>105 Type or more</th> </tr> </thead> <tbody> <tr> <td>Applied force</td> <td>2N</td> <td>5N</td> </tr> <tr> <td>Duration</td> <td colspan="2">30\pm5 sec.</td> </tr> </tbody> </table>			Multilayer Ceramic Capacitors		021, 042, 063 Type	105 Type or more	Applied force	2N	5N	Duration	30 \pm 5 sec.		
		Multilayer Ceramic Capacitors												
		021, 042, 063 Type	105 Type or more											
Applied force	2N	5N												
Duration	30 \pm 5 sec.													

12. Solderability															
Specified Value	Temperature Compensating(Class1)	Standard	At least 95% of terminal electrode is covered by new solder.												
		High Frequency Type													
	High Permittivity (Class2)														
Test Methods and Remarks	<table border="1"> <thead> <tr> <th></th> <th>Eutectic solder</th> <th>Lead-free solder</th> </tr> </thead> <tbody> <tr> <td>Solder type</td> <td>H60A or H63A</td> <td>Sn-3.0Ag-0.5Cu</td> </tr> <tr> <td>Solder temperature</td> <td>230\pm5$^{\circ}$C</td> <td>245\pm3$^{\circ}$C</td> </tr> <tr> <td>Duration</td> <td colspan="2">4\pm1 sec.</td> </tr> </tbody> </table>			Eutectic solder	Lead-free solder	Solder type	H60A or H63A	Sn-3.0Ag-0.5Cu	Solder temperature	230 \pm 5 $^{\circ}$ C	245 \pm 3 $^{\circ}$ C	Duration	4 \pm 1 sec.		
		Eutectic solder	Lead-free solder												
	Solder type	H60A or H63A	Sn-3.0Ag-0.5Cu												
	Solder temperature	230 \pm 5 $^{\circ}$ C	245 \pm 3 $^{\circ}$ C												
Duration	4 \pm 1 sec.														

► This catalog contains the typical specification only due to the limitation of space. When you consider the purchase of our products, please check our specification. For details of each product (characteristics graph, reliability information, precautions for use, and so on), see our Web site (<http://www.ty-top.com/>).

13. Resistance to Soldering

Specified Value	Temperature Compensating(Class1)	Standard	Appearance : No abnormality Capacitance change : Within $\pm 2.5\%$ or $\pm 0.25\text{pF}$, whichever is larger. Q : Initial value Insulation resistance : Initial value Withstanding voltage (between terminals) : No abnormality
		High Frequency Type	Appearance : No abnormality Capacitance change : Within $\pm 2.5\%$ Q : Initial value Insulation resistance : Initial value Withstanding voltage (between terminals) : No abnormality
	High Permittivity (Class2) Note 1		Appearance : No abnormality Capacitance change : Within $\pm 7.5\%$ Dissipation factor : Initial value Insulation resistance : Initial value Withstanding voltage (between terminals): No abnormality

Test Methods and Remarks	Class 1			
		021, 042, 063 Type	105 Type	
	Preconditioning	None		
	Preheating	150°C, 1 to 2 min.	80 to 100°C, 2 to 5 min. 150 to 200°C, 2 to 5 min.	
	Solder temp.	270 \pm 5°C		
	Duration	3 \pm 0.5 sec.		
	Recovery	6 to 24 hrs (Standard condition) Note 5		
	Class 2			
		021, 042, 063 Type	105, 107, 212 Type	316, 325, 432 Type
	Preconditioning	Thermal treatment (at 150°C for 1 hr) Note 2		
	Preheating	150°C, 1 to 2 min.	80 to 100°C, 2 to 5 min. 150 to 200°C, 2 to 5 min.	80 to 100°C, 5 to 10 min. 150 to 200°C, 5 to 10 min.
	Solder temp.	270 \pm 5°C		
	Duration	3 \pm 0.5 sec.		
	Recovery	24 \pm 2 hrs (Standard condition) Note 5		

14. Temperature Cycle (Thermal Shock)

Specified Value	Temperature Compensating(Class1)	Standard	Appearance : No abnormality Capacitance change : Within $\pm 2.5\%$ or $\pm 0.25\text{pF}$, whichever is larger. Q : Initial value Insulation resistance : Initial value Withstanding voltage (between terminals) : No abnormality
		High Frequency Type	Appearance : No abnormality Capacitance change : Within $\pm 0.25\text{pF}$ Q : Initial value Insulation resistance : Initial value Withstanding voltage (between terminals) : No abnormality
	High Permittivity (Class2) Note 1		Appearance : No abnormality Capacitance change : Within $\pm 7.5\%$ Dissipation factor : Initial value Insulation resistance : Initial value Withstanding voltage (between terminals) : No abnormality

Test Methods and Remarks	Class 1		Class 2		
	Preconditioning	None		Thermal treatment (at 150°C for 1 hr) Note 2	
	1 cycle	Step	Temperature (°C)	Time (min.)	
		1	Minimum operating temperature	30 \pm 3	
		2	Normal temperature	2 to 3	
3		Maximum operating temperature	30 \pm 3		
4	Normal temperature	2 to 3			
Number of cycles	5 times				
Recovery	6 to 24 hrs (Standard condition) Note 5		24 \pm 2 hrs (Standard condition) Note 5		

▶ This catalog contains the typical specification only due to the limitation of space. When you consider the purchase of our products, please check our specification. For details of each product (characteristics graph, reliability information, precautions for use, and so on), see our Web site (<http://www.ty-top.com/>).

15. Humidity (Steady State)

Specified Value	Temperature Compensating(Class1)	Standard	Appearance : No abnormality Capacitance change : Within $\pm 5\%$ or $\pm 0.5\text{pF}$, whichever is larger. Q : $C < 10\text{pF} : Q \geq 200 + 10C$ $10 \leq C < 30\text{pF} : Q \geq 275 + 2.5C$ $C \geq 30\text{pF} : Q \geq 350 (C : \text{Nominal capacitance})$ Insulation resistance : $1000 \text{ M}\Omega \text{ min.}$
		High Frequency Type	Appearance : No abnormality Capacitance change : Within $\pm 0.5\text{pF}$, Insulation resistance : $1000 \text{ M}\Omega \text{ min.}$
	High Permittivity (Class2) Note 1		Appearance : No abnormality Capacitance change : Within $\pm 12.5\%$ Dissipation factor : 5.0% max. Insulation resistance : $50 \text{ M}\Omega/\mu\text{F}$ or $1000 \text{ M}\Omega$ whichever is smaller.

Test Methods and Remarks		Class 1		Class 2
		Standard	High Frequency Type	All items
	Preconditioning	None		Thermal treatment (at 150°C for 1 hr) Note 2
	Temperature	$40 \pm 2^\circ\text{C}$	$60 \pm 2^\circ\text{C}$	$40 \pm 2^\circ\text{C}$
	Humidity	90 to 95%RH		90 to 95%RH
	Duration	$500 + 24 / - 0$ hrs		$500 + 24 / - 0$ hrs
	Recovery	6 to 24 hrs (Standard condition) Note 5		24 ± 2 hrs (Standard condition) Note 5

16. Humidity Loading

Specified Value	Temperature Compensating(Class1)	Standard	Appearance : No abnormality Capacitance change : Within $\pm 7.5\%$ or $\pm 0.75\text{pF}$, whichever is larger. Q : $C < 30\text{pF} : Q \geq 100 + 10C/3$ $C \geq 30\text{pF} : Q \geq 200 (C : \text{Nominal capacitance})$ Insulation resistance : $500 \text{ M}\Omega \text{ min.}$
		High Frequency Type	Appearance : No abnormality Capacitance change : $C \leq 2\text{pF} : \text{Within } \pm 0.4 \text{ pF}$ $C > 2\text{pF} : \text{Within } \pm 0.75 \text{ pF}$ (C:Nominal capacitance) Insulation resistance : $500 \text{ M}\Omega \text{ min.}$
	High Permittivity (Class2) Note 1		Appearance : No abnormality Capacitance change : Within $\pm 12.5\%$ Dissipation factor : 5.0% max. Insulation resistance : $25 \text{ M}\Omega/\mu\text{F}$ or $500 \text{ M}\Omega$ whichever is smaller.

Test Methods and Remarks		Class 1		Class 2
		Standard	High Frequency Type	All items
	Preconditioning	None		Voltage treatment (Rated voltage are applied for 1 hour at 40°C) Note 3
	Temperature	$40 \pm 2^\circ\text{C}$	$60 \pm 2^\circ\text{C}$	$40 \pm 2^\circ\text{C}$
	Humidity	90 to 95%RH		90 to 95%RH
	Duration	$500 + 24 / - 0$ hrs		$500 + 24 / - 0$ hrs
	Applied voltage	Rated voltage		Rated voltage
	Charge/discharge current	50mA max.		50mA max.
Recovery	6 to 24 hrs (Standard condition) Note 5		24 ± 2 hrs (Standard condition) Note 5	

► This catalog contains the typical specification only due to the limitation of space. When you consider the purchase of our products, please check our specification. For details of each product (characteristics graph, reliability information, precautions for use, and so on), see our Web site (<http://www.ty-top.com/>).

17. High Temperature Loading

Specified Value	Temperature Compensating(Class1)	Standard	Appearance : No abnormality Capacitance change : Within $\pm 3\%$ or $\pm 0.3\text{pF}$, whichever is larger. Q : $C < 10\text{pF}$: $Q \geq 200 + 10C$ $10 \leq C < 30\text{pF}$: $Q \geq 275 + 2.5C$ $C \geq 30\text{pF}$: $Q \geq 350$ (C: Nominal capacitance) Insulation resistance : 1000 M Ω min.
		High Frequency Type	Appearance : No abnormality Capacitance change : Within $\pm 3\%$ or $\pm 0.3\text{pF}$, whichever is larger. Insulation resistance : 1000 M Ω min.
	High Permittivity (Class2) Note 1		Appearance : No abnormality Capacitance change : Within $\pm 12.5\%$ Dissipation factor : 5.0% max. Insulation resistance : 50 M Ω μF or 1000 M Ω whichever is smaller.

Test Methods and Remarks		Class 1		Class 2		
		Standard	High Frequency Type	BJ, LD(※)	C6	B7, C7
	Preconditioning	None		Voltage treatment (Twice the rated voltage shall be applied for 1 hour at 85°C, 105°C or 125°C) Note 3, 4		
	Temperature	Maximum operating temperature		Maximum operating temperature		
	Duration	1000+48/-0 hrs		1000+48/-0 hrs		
	Applied voltage	Rated voltage $\times 2$ Note 4		Rated voltage $\times 2$ Note 4		
	Charge/discharge current	50mA max.		50mA max.		
	Recovery	6 to 24hr (Standard condition) Note 5		24 ± 2 hrs (Standard condition) Note 5		
Note: ※LD Low distortion high value multilayer ceramic capacitor						

Note 1 The figures indicate typical specifications. Please refer to individual specifications in detail.

Note 2 Thermal treatment : Initial value shall be measured after test sample is heat-treated at 150+0/-10°C for an hour and kept at room temperature for 24 ± 2 hours.

Note 3 Voltage treatment : Initial value shall be measured after test sample is voltage-treated for an hour at both the temperature and voltage specified in the test conditions, and kept at room temperature for 24 ± 2 hours.

Note 4 150% of rated voltage is applicable to some items. Please refer to their specifications for further information.

Note 5 Standard condition: Temperature: 5 to 35°C, Relative humidity: 45 to 85 % RH, Air pressure: 86 to 106kPa When there are questions concerning measurement results, in order to provide correlation data, the test shall be conducted under the following condition.
Temperature: 20 ± 2 °C, Relative humidity: 60 to 70 % RH, Air pressure: 86 to 106kPa Unless otherwise specified, all the tests are conducted under the "standard condition".

Precautions on the use of Multilayer Ceramic Capacitors

PRECAUTIONS

1. Circuit Design

◆Verification of operating environment, electrical rating and performance

1. A malfunction of equipment in fields such as medical, aerospace, nuclear control, etc. may cause serious harm to human life or have severe social ramifications.
Therefore, any capacitors to be used in such equipment may require higher safety and reliability, and shall be clearly differentiated from them used in general purpose applications.

◆Operating Voltage (Verification of Rated voltage)

1. The operating voltage for capacitors must always be their rated voltage or less.
If an AC voltage is loaded on a DC voltage, the sum of the two peak voltages shall be the rated voltage or less.
For a circuit where an AC or a pulse voltage may be used, the sum of their peak voltages shall also be the rated voltage or less.

2. Even if an applied voltage is the rated voltage or less reliability of capacitors may be deteriorated in case that either a high frequency AC voltage or a pulse voltage having rapid rise time is used in a circuit.

2. PCB Design

◆Pattern configurations (Design of Land-patterns)

1. When capacitors are mounted on PCBs, the amount of solder used (size of fillet) can directly affect the capacitor performance.
Therefore, the following items must be carefully considered in the design of land patterns:

(1) Excessive solder applied can cause mechanical stresses which lead to chip breaking or cracking. Therefore, please consider appropriate land-patterns for proper amount of solder.

(2) When more than one component are jointly soldered onto the same land, each component's soldering point shall be separated by solder-resist.

◆Pattern configurations (Capacitor layout on PCBs)

After capacitors are mounted on boards, they can be subjected to mechanical stresses in subsequent manufacturing processes (PCB cutting, board inspection, mounting of additional parts, assembly into the chassis, wave soldering of the boards, etc.). For this reason, land pattern configurations and positions of capacitors shall be carefully considered to minimize stresses.

◆Pattern configurations (Design of Land-patterns)

The following diagrams and tables show some examples of recommended land patterns to prevent excessive solder amounts.

(1) Recommended land dimensions for typical chip capacitors

● Multilayer Ceramic Capacitors : Recommended land dimensions (unit: mm)

Wave-soldering

Type		107	212	316	325
Size	L	1.6	2.0	3.2	3.2
	W	0.8	1.25	1.6	2.5
A		0.8 to 1.0	1.0 to 1.4	1.8 to 2.5	1.8 to 2.5
B		0.5 to 0.8	0.8 to 1.5	0.8 to 1.7	0.8 to 1.7
C		0.6 to 0.8	0.9 to 1.2	1.2 to 1.6	1.8 to 2.5

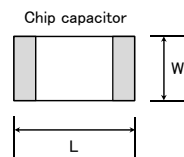
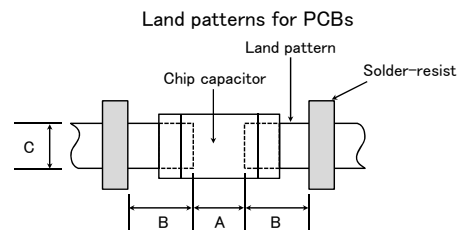

Reflow-soldering

Type		021	042	063	105	107	212	316	325	432
Size	L	0.25	0.4	0.6	1.0	1.6	2.0	3.2	3.2	4.5
	W	0.125	0.2	0.3	0.5	0.8	1.25	1.6	2.5	3.2
A		0.095~0.135	0.15~0.25	0.20~0.30	0.45~0.55	0.8~1.0	0.8~1.2	1.8~2.5	1.8~2.5	2.5~3.5
B		0.085~0.125	0.15~0.20	0.20~0.30	0.40~0.50	0.6~0.8	0.8~1.2	1.0~1.5	1.0~1.5	1.5~1.8
C		0.110~0.150	0.15~0.30	0.25~0.40	0.45~0.55	0.6~0.8	0.9~1.6	1.2~2.0	1.8~3.2	2.3~3.5

Note: Recommended land size might be different according to the allowance of the size of the product.

● LWDC: Recommended land dimensions for reflow-soldering (unit: mm)

Type		105	107	212
Size	L	0.52	0.8	1.25
	W	1.0	1.6	2.0
A		0.18~0.22	0.25~0.3	0.5~0.7
B		0.2~0.25	0.3~0.4	0.4~0.5
C		0.9~1.1	1.5~1.7	1.9~2.1

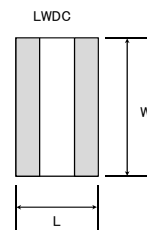

Technical considerations

▶ This catalog contains the typical specification only due to the limitation of space. When you consider the purchase of our products, please check our specification. For details of each product (characteristics graph, reliability information, precautions for use, and so on), see our Web site (<http://www.ty-top.com/>).

(2) Examples of good and bad solder application

Item	Not recommended	Recommended
Mixed mounting of SMD and leaded components		
Component placement close to the chassis		
Hand-soldering of leaded components near mounted components		
Horizontal component placement		

◆ Pattern configurations (Capacitor layout on PCBs)

1-1. The following is examples of good and bad capacitor layouts ; capacitors shall be located to minimize any possible mechanical stresses from board warp or deflection.

Items	Not recommended	Recommended
Deflection of board		 Place the product at a right angle to the direction of the anticipated mechanical stress.

1-2. The amount of mechanical stresses given will vary depending on capacitor layout. Please refer to diagram below.

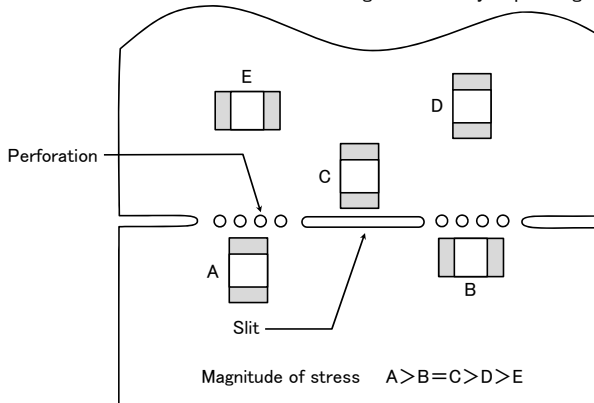

1-3. When PCB is split, the amount of mechanical stress on the capacitors can vary according to the method used. The following methods are listed in order from least stressful to most stressful: push-back, slit, V-grooving, and perforation. Thus, please consider the PCB, split methods as well as chip location.

3. Mounting

Precautions

◆ Adjustment of mounting machine

- When capacitors are mounted on PCB, excessive impact load shall not be imposed on them.
- Maintenance and inspection of mounting machines shall be conducted periodically.

◆ Selection of Adhesives

- When chips are attached on PCBs with adhesives prior to soldering, it may cause capacitor characteristics degradation unless the following factors are appropriately checked : size of land patterns, type of adhesive, amount applied, hardening temperature and hardening period. Therefore, please contact us for further information.

◆Adjustment of mounting machine

1. When the bottom dead center of a pick-up nozzle is too low, excessive force is imposed on capacitors and causes damages. To avoid this, the following points shall be considerable.
 - (1) The bottom dead center of the pick-up nozzle shall be adjusted to the surface level of PCB without the board deflection.
 - (2) The pressure of nozzle shall be adjusted between 1 and 3 N static loads.
 - (3) To reduce the amount of deflection of the board caused by impact of the pick-up nozzle, supporting pins or back-up pins shall be used on the other side of the PCB. The following diagrams show some typical examples of good and bad pick-up nozzle placement:

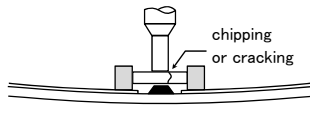
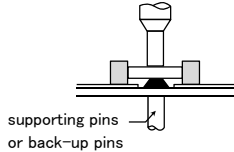
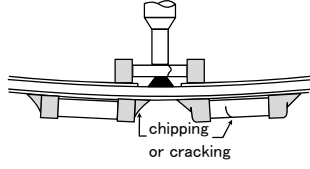
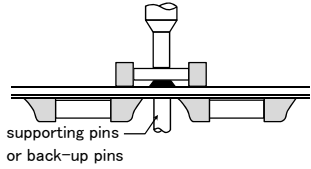
Item	Improper method	Proper method
Single-sided mounting		
Double-sided mounting		

Technical considerations

2. As the alignment pin is worn out, adjustment of the nozzle height can cause chipping or cracking of capacitors because of mechanical impact on the capacitors. To avoid this, the monitoring of the width between the alignment pins in the stopped position, maintenance, check and replacement of the pin shall be conducted periodically.

◆Selection of Adhesives

Some adhesives may cause IR deterioration. The different shrinkage percentage of between the adhesive and the capacitors may result in stresses on the capacitors and lead to cracking. Moreover, too little or too much adhesive applied to the board may adversely affect components. Therefore, the following precautions shall be noted in the application of adhesives.

- (1) Required adhesive characteristics
 - a. The adhesive shall be strong enough to hold parts on the board during the mounting & solder process.
 - b. The adhesive shall have sufficient strength at high temperatures.
 - c. The adhesive shall have good coating and thickness consistency.
 - d. The adhesive shall be used during its prescribed shelf life.
 - e. The adhesive shall harden rapidly.
 - f. The adhesive shall have corrosion resistance.
 - g. The adhesive shall have excellent insulation characteristics.
 - h. The adhesive shall have no emission of toxic gasses and no effect on the human body.
- (2) The recommended amount of adhesives is as follows;

[Recommended condition]

Figure	212/316 case sizes as examples
a	0.3mm min
b	100 to 120 μm
c	Adhesives shall not contact land

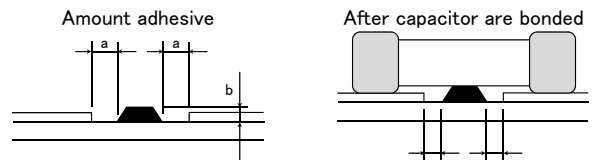

4. Soldering

◆Selection of Flux

- Since flux may have a significant effect on the performance of capacitors, it is necessary to verify the following conditions prior to use;
- (1) Flux used shall be less than or equal to 0.1 wt% (in Cl equivalent) of halogenated content. Flux having a strong acidity content shall not be applied.
 - (2) When shall capacitors are soldered on boards, the amount of flux applied shall be controlled at the optimum level.
 - (3) When water-soluble flux is used, special care shall be taken to properly clean the boards.

Precautions

◆Soldering

Temperature, time, amount of solder, etc. shall be set in accordance with their recommended conditions.
 Sn-Zn solder paste can adversely affect MLOC reliability.
 Please contact us prior to usage of Sn-Zn solder.

Technical considerations

◆Selection of Flux

- 1-1. When too much halogenated substance (Chlorine, etc.) content is used to activate flux, or highly acidic flux is used, it may lead to corrosion of terminal electrodes or degradation of insulation resistance on the surfaces of the capacitors.
- 1-2. Flux is used to increase solderability in wave soldering. However if too much flux is applied, a large amount of flux gas may be emitted and may adversely affect the solderability. To minimize the amount of flux applied, it is recommended to use a flux-bubbling system.
- 1-3. Since the residue of water-soluble flux is easily dissolved in moisture in the air, the residues on the surfaces of capacitors in high humidity conditions may cause a degradation of insulation resistance and reliability of the capacitors. Therefore, the cleaning methods and the capability of the machines used shall also be considered carefully when water-soluble flux is used.

▶ This catalog contains the typical specification only due to the limitation of space. When you consider the purchase of our products, please check our specification. For details of each product (characteristics graph, reliability information, precautions for use, and so on), see our Web site (<http://www.ty-top.com/>).

◆ Soldering

- Ceramic chip capacitors are susceptible to thermal shock when exposed to rapid or concentrated heating or rapid cooling.
- Therefore, the soldering must be conducted with great care so as to prevent malfunction of the components due to excessive thermal shock.
- Preheating : Capacitors shall be preheated sufficiently, and the temperature difference between the capacitors and solder shall be within 130°C.
- Cooling : The temperature difference between the capacitors and cleaning process shall not be greater than 100°C.

[Reflow soldering]

【Recommended conditions for eutectic soldering】

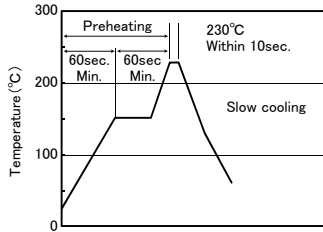

【Recommended condition for Pb-free soldering】

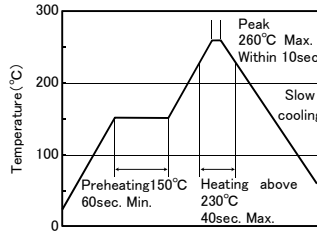

Caution

- ① The ideal condition is to have solder mass (fillet) controlled to 1/2 to 1/3 of the thickness of a capacitor.
- ② Because excessive dwell times can adversely affect solderability, soldering duration shall be kept as close to recommended times as possible. soldering for 2 times.

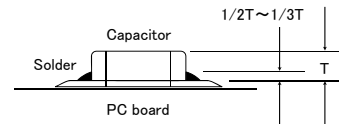

[Wave soldering]

【Recommended conditions for eutectic soldering】

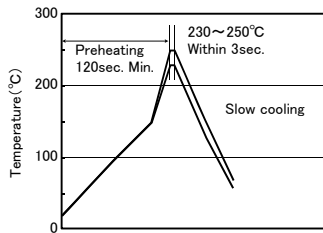

【Recommended condition for Pb-free soldering】

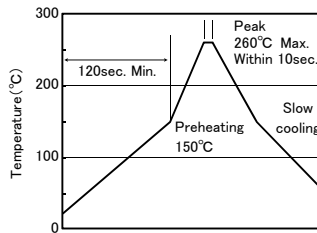

Caution

- ① Wave soldering must not be applied to capacitors designated as for reflow soldering only. soldering for 1 times.

[Hand soldering]

【Recommended conditions for eutectic soldering】

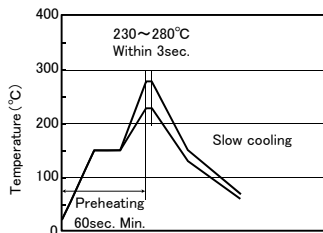

【Recommended condition for Pb-free soldering】

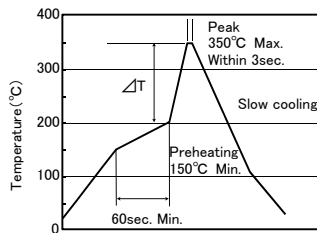

316type or less	$\Delta T \leq 150^{\circ}\text{C}$
-----------------	-------------------------------------

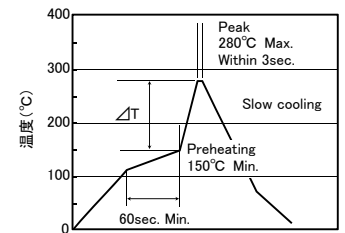

325type or more	$\Delta T \leq 130^{\circ}\text{C}$
-----------------	-------------------------------------

Caution

- ① Use a 50W soldering iron with a maximum tip diameter of 1.0 mm.
- ② The soldering iron shall not directly touch capacitors. soldering for 1 times.

5. Cleaning	
Precautions	<p>◆Cleaning conditions</p> <ol style="list-style-type: none"> When PCBs are cleaned after capacitors mounting, please select the appropriate cleaning solution in accordance with the intended use of the cleaning. (e.g. to remove soldering flux or other materials from the production process.) Cleaning condition shall be determined after it is verified by using actual cleaning machine that the cleaning process does not affect capacitor's characteristics.
Technical considerations	<ol style="list-style-type: none"> The use of inappropriate cleaning solutions can cause foreign substances such as flux residue to adhere to capacitors or deteriorate their outer coating, resulting in a degradation of the capacitor's electrical properties (especially insulation resistance). Inappropriate cleaning conditions (insufficient or excessive cleaning) may adversely affect the performance of the capacitors. In the case of ultrasonic cleaning, too much power output can cause excessive vibration of PCBs which may lead to the cracking of capacitors or the soldered portion, or decrease the terminal electrodes' strength. Therefore, the following conditions shall be carefully checked; Ultrasonic output : 20 W/l or less Ultrasonic frequency : 40 kHz or less Ultrasonic washing period : 5 min. or less

6. Resin coating and mold	
Precautions	<ol style="list-style-type: none"> With some type of resins, decomposition gas or chemical reaction vapor may remain inside the resin during the hardening period or while left under normal storage conditions resulting in the deterioration of the capacitor's performance. When a resin's hardening temperature is higher than capacitor's operating temperature, the stresses generated by the excessive heat may lead to damage or destruction of capacitors. The use of such resins, molding materials etc. is not recommended.

7. Handling	
Precautions	<p>◆Splitting of PCB</p> <ol style="list-style-type: none"> When PCBs are split after components mounting, care shall be taken so as not to give any stresses of deflection or twisting to the board. Board separation shall not be done manually, but by using the appropriate devices. <p>◆Mechanical considerations</p> <p>Be careful not to subject capacitors to excessive mechanical shocks.</p> <p>(1) If ceramic capacitors are dropped onto a floor or a hard surface, they shall not be used.</p> <p>(2) Please be careful that the mounted components do not come in contact with or bump against other boards or components.</p>

8. Storage conditions	
Precautions	<p>◆Storage</p> <ol style="list-style-type: none"> To maintain the solderability of terminal electrodes and to keep packaging materials in good condition, care must be taken to control temperature and humidity in the storage area. Humidity should especially be kept as low as possible. <ul style="list-style-type: none"> Recommended conditions Ambient temperature : Below 30°C Humidity : Below 70% RH The ambient temperature must be kept below 40°C. Even under ideal storage conditions, solderability of capacitor is deteriorated as time passes, so capacitors shall be used within 6 months from the time of delivery. Ceramic chip capacitors shall be kept where no chlorine or sulfur exists in the air. The capacitance values of high dielectric constant capacitors will gradually decrease with the passage of time, so care shall be taken to design circuits. Even if capacitance value decreases as time passes, it will get back to the initial value by a heat treatment at 150°C for 1 hour.
Technical considerations	<p>If capacitors are stored in a high temperature and humidity environment, it might rapidly cause poor solderability due to terminal oxidation and quality loss of taping/packaging materials. For this reason, capacitors shall be used within 6 months from the time of delivery. If exceeding the above period, please check solderability before using the capacitors.</p>

※RCR-2335B (Safety Application Guide for fixed ceramic capacitors for use in electronic equipment) is published by JEITA.

Please check the guide regarding precautions for deflection test, soldering by spot heat, and so on.

X-ON Electronics

Largest Supplier of Electrical and Electronic Components

Click to view similar products for [Multilayer Ceramic Capacitors MLCC - SMD/SMT category:](#)

Click to view products by [Taiyo Yuden manufacturer:](#)

Other Similar products are found below :

[M39014/02-1225V](#) [M39014/22-0631](#) [D55342E07B523DR-T/R](#) [NCA1206X7R103K50TRPF](#) [NCA1206X7R104K16TRPF](#) [NIN-FB391JTRF](#)
[NIN-FC2R7JTRF](#) [NMC0201X5R474K4TRPF](#) [NMC0402NPO220J50TRPF](#) [NMC0402X5R105K6.3TRPF](#) [NMC0402X5R224K6.3TRPF](#)
[NMC0402X7R103J25TRPF](#) [NMC0402X7R153K16TRPF](#) [NMC0603NPO1R8C50TRPF](#) [NMC0603NPO201J50TRPF](#)
[NMC0603NPO330G50TRPF](#) [NMC0603X5R475M6.3TRPF](#) [NMC0805NPO270J50TRPF](#) [NMC0805NPO820J50TRPF](#)
[NMC0805X7R224K16TRPLPF](#) [NMC0805X7R224K25TRPF](#) [NMC1206X7R102K50TRPF](#) [NMC1206X7R106K10TRPLPF](#)
[NMC1206X7R475K10TRPLPF](#) [NMC-H0805X7R472K250TRPF](#) [NMC-L0402NPO7R0C50TRPF](#) [NMC-L0603NPO2R2B50TRPF](#) [NMC-](#)
[Q0402NPO8R2D200TRPF](#) [C1206C101J1GAC](#) [C1608C0G2A221J](#) [C1608X7R1E334K](#) [C2012C0G2A472J](#) [2220J2K00562KXT](#)
[1812J2K00332KXT](#) [CDR31BX103AKWR](#) [CDR33BX104AKUR](#) [CDR33BX683AKUS](#) [CGA2B2C0G1H010C](#) [CGA2B2C0G1H040C](#)
[CGA2B2C0G1H050C](#) [CGA2B2C0G1H060D](#) [CGA2B2C0G1H070D](#) [CGA2B2C0G1H120J](#) [CGA2B2C0G1H151J](#)
[CGA2B2C0G1H181JT0Y0F](#) [CGA2B2C0G1H1R5C](#) [CGA2B2C0G1H2R2C](#) [CGA2B2C0G1H390J](#) [CGA2B2C0G1H391J](#)
[CGA2B2C0G1H3R3C](#)